



Refrigerator

Use & Care Guide

Table of Contents



Important Safety Instructions 1-2



Installation 3-9



Temperature Controls..... 10-11



Fresh Food Features 12-15



Freezer Features..... 16-17



Food Storage Tips..... 18-20



Care and Cleaning 21-24



Operating Sounds 25



Troubleshooting..... 26-28



Warranty & Service 29

Guide d'utilisation et d'entretien..... 30

Guía de uso y cuidado 60



Important Safety Instructions

Installer: Please leave this guide with this appliance.

Consumer: Please read and keep this Use & Care Guide for future reference. This guide provides proper use and maintenance information.

Keep sales receipt and/or cancelled check as proof of purchase.

Call: 1-800-688-9900 U.S.A.
1-800-688-2002 Canada

Have complete model and serial number identification of your refrigerator. This is located on a data plate inside the refrigerator compartment, on the upper left side. Record these numbers below for easy access.

Model Number _____

Revision Number _____

Serial Number _____

Date of Purchase _____

In our continuing effort to improve the quality and performance of our appliances, it may be necessary to make changes to the appliance without revising this guide.

What You Need to Know About Safety Instructions

Warning and Important Safety Instructions appearing in this guide are not meant to cover all possible conditions and situations that may occur. Common sense, caution and care must be exercised when installing, maintaining or operating appliance.

Always contact the manufacturer about problems or conditions you do not understand.

Recognize Safety Symbols, Words, Labels

⚠ DANGER

DANGER – Immediate hazards which **WILL** result in severe personal injury or death.

⚠ WARNING

WARNING – Hazards or unsafe practices which **COULD** result in severe personal injury or death.

⚠ CAUTION

CAUTION – Hazards or unsafe practices which **COULD** result in minor personal injury or property damage.

⚠ DANGER

To reduce risk of injury or death, follow basic precautions, including the following:

IMPORTANT: Child entrapment and suffocation are not problems of the past. Junked or abandoned refrigerators are still dangerous – even if they sit out for “just a few days.” If you are getting rid of your old refrigerator, please follow the instructions below to help prevent accidents.

Before you throw away your old refrigerator or freezer:

- Take off the doors.
- Leave the shelves in place so children may not easily climb inside.

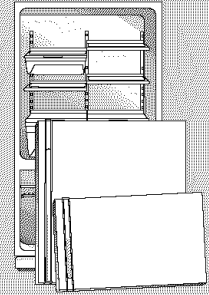

This appliance is equipped with a three-prong grounding plug for your protection against possible electrical shock hazards. It must be plugged into a grounding receptacle. Where a standard two-prong wall receptacle is encountered, it is the personal responsibility and obligation of the customer to have it replaced with a properly grounded three-prong wall receptacle. Do not under any circumstances, cut or remove the third (ground) prong from the power cord. Do not use an adapter plug.

Power supply cord with three-prong grounding plug

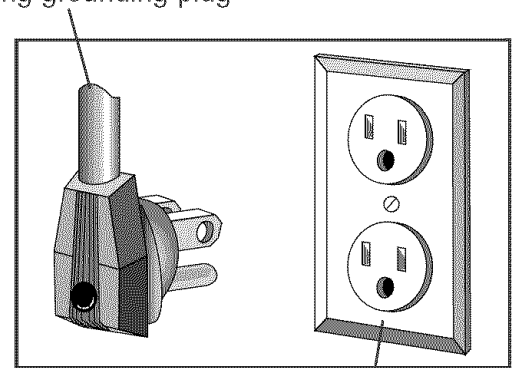

Grounding type wall receptacle



Important Safety Instructions

⚠ WARNING

To reduce risk of fire, electric shock, serious injury or death when using your refrigerator, follow these basic precautions, including the following:

1. Read all instructions before using the refrigerator.
2. Observe all local codes and ordinances.
3. Be sure to follow grounding instructions.
4. Check with a qualified electrician if you are not sure this appliance is properly grounded.
5. Do not ground to a gas line.
6. Do not ground to a cold-water pipe.
7. Refrigerator is designed to operate on a separate 115 volt, 15 amp., 60 cycle line.
8. Do not modify plug on power cord. If plug does not fit electrical outlet, have proper outlet installed by a qualified electrician.
9. Do not use a two-prong adapter, extension cord or power strip.
10. Do not remove warning tag from power cord.
11. Do not tamper with refrigerator controls.
12. Do not service or replace any part of refrigerator unless specifically recommended in Use & Care Guide or published user-repair instructions. Do not attempt service if instructions are not understood or if they are beyond personal skill level.
13. Always disconnect refrigerator from electrical supply before attempting any service. Disconnect power cord by grasping the plug, not the cord.
14. Install refrigerator according to Installation Instructions. All connections for water, electrical power and grounding must comply with local codes and be made by licensed personnel when required.
15. Keep your refrigerator in good condition. Bumping or dropping refrigerator can damage refrigerator or cause refrigerator to malfunction or leak. If damage occurs, have refrigerator checked by qualified service technician.
16. Replace worn power cords and/or loose plugs.
17. Always read and follow manufacturer's storage and ideal environment instructions for items being stored in refrigerator.
18. Your refrigerator should not be operated in the presence of explosive fumes.
19. Children should not climb, hang or stand on any part of the refrigerator.
20. Clean up spills or water leakage associated with water installation.

SAVE THESE INSTRUCTIONS



Installation

Your refrigerator was packed carefully for shipment. Remove and discard shelf packaging and tape. Do not remove the serial plate.

Location

- Do not install refrigerator near oven, radiator or other heat source. If not possible, shield refrigerator with cabinet material.
- Do not install where temperature falls below 55° F (13° C) or rises above 110° F (43° C). Malfunction may occur at this temperature.
- **Refrigerator is designed for indoor household application only.**

Measuring the Opening

When installing your refrigerator, measure carefully. Allow 1/2" space at top and 1/2" space behind the machine compartment cover (located in the rear) for proper air circulation.

Subflooring or floor coverings (i.e. carpet, tile, wood floors, rugs) may make your opening smaller than anticipated.

Some clearance may be gained by using the leveling procedure under *Leveling*.

IMPORTANT: If refrigerator is to be installed into a recess where the top of the refrigerator is completely covered, use dimensions from floor to top of hinge cap to verify proper clearance.

Transporting Your Refrigerator

- **NEVER** transport refrigerator on its side. If an upright position is not possible, lay refrigerator on its back. Allow refrigerator to sit upright for approximately 30 minutes before plugging it in to assure oil returns to the compressor. Plugging the refrigerator in immediately may cause damage to internal parts.
- Use an appliance dolly when moving refrigerator. **ALWAYS** truck refrigerator from its side or back—**NEVER** from its front.
- Protect outside finish of refrigerator during transport by wrapping cabinet in blankets or inserting padding between the refrigerator and dolly.
- Secure refrigerator to dolly firmly with straps or bungee cords. Thread straps through handles when possible. Do not overtighten. Overtightening restraints may dent or damage outside finish.

Leveling

⚠ CAUTION

To protect property and refrigerator from damage, observe the following:

- Protect vinyl or other flooring with cardboard, rugs, or other protective material.
- Do not use power tools when performing leveling procedure.

To enhance the appearance and maintain performance, the refrigerator should be level.

Note

- Complete any required door reversal, panel installation and/or a water supply connection, before leveling.

Materials Needed

- 3/8" hex head driver
- Carpenter's level

1. Remove toe grille.

- Grasp firmly and pull outward to unclip.

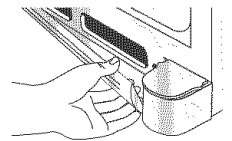

2. Remove bottom bracket cover(s).

- Place the eraser end of a pencil or similar blunt tool in the cover notch.

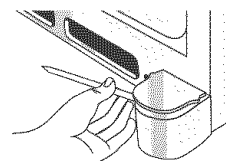

Notch Location →

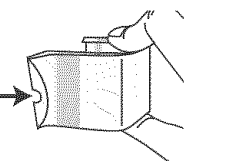

- Use slight pressure to pry the cover loose.
- Continue to maintain downward pressure to the notched side of the cover while swinging it off.

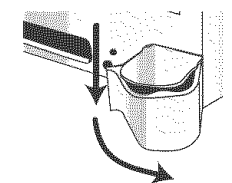



Installation

- Using hex head driver, turn the front adjustment screws (A) on each side to raise or lower the front of the refrigerator.

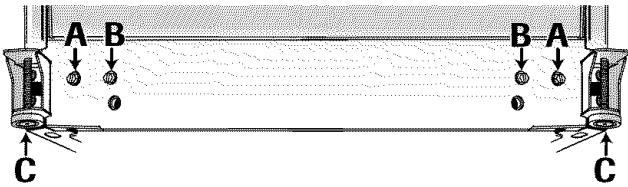

Note

- Some models only have adjustment screws "A."

- Select models also have rear adjustment screws (B). Using the hex head driver, turn each of these adjustment screws (B) to raise or lower the rear of the refrigerator.
- Using the carpenter's level, make sure front of refrigerator is $\frac{1}{4}$ " (6 mm) or $\frac{1}{2}$ bubble higher than back of refrigerator and that the refrigerator is level from side to side.
- Turn stabilizing legs (C) clockwise until firmly against floor.
- Freezer drawer models only:** Turn adjustment screws (A) counterclockwise to allow the full weight of the refrigerator to rest on the stabilizing legs.
- Replace bracket cover(s).
 - Position cover into the outer edge of the hinge.
 - Swing the cover toward the cabinet and snap it into place.
- Replace the toe grille.

Note

- For proper reinstallation, ensure the "top" marking on the interior of the toe grille is oriented correctly.
- Align the toe grille mounting clips with the lower cabinet slots.
- Push the toe grille firmly until it snaps into place.

Door and Drawer Removal

Some installations require door/drawer removal to transport the refrigerator to its final location.

⚠ WARNING

To avoid electrical shock which can cause severe personal injury or death, observe the following:

- Disconnect power to refrigerator before removing doors or drawer. Connect power only after replacing doors or drawer.

⚠ CAUTION

To avoid damage to walls and flooring, protect vinyl or other flooring with cardboard, rugs or other protective material.

- Unplug power cord from power source.
- Remove toe grille and bottom bracket cover(s) (see page 3).
- Remove top hinge cover from refrigerator door by removing Phillips screw and retain screw and cover for later use.
- Unscrew $\frac{5}{16}$ " hex head screws from top hinge to remove hinge and retain all screws for later use.
- Lift refrigerator door from center hinge pin.
- For swing freezer door models only:** Hold freezer door while removing hinge pin with a $\frac{5}{16}$ " hex head driver. Remove door from bottom hinge and retain hinge pin for later use.

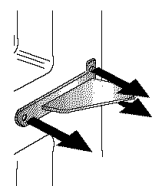
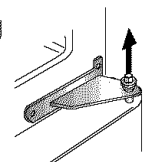
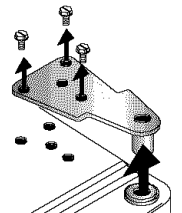
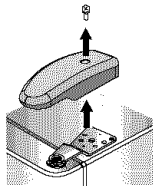

For pullout freezer drawer models only:

Remove plastic sleeve, if present. Remove center hinge pin with a $\frac{5}{16}$ " hex head driver. Retain hinge pin and plastic sleeve for later use.

- Remove Phillips screws to remove center hinge and retain all screws for later use.
- Remove bottom hinge or stabilizing bracket with $\frac{5}{8}$ " hex head driver and retain screws for later use. Lift out bottom hinge pin (on freezer door models).
- If your model has a pullout freezer drawer, see page 5 for drawer removal instructions.

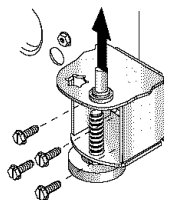

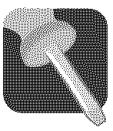

Installation

Pullout Freezer Drawer (select models)

⚠ DANGER

To prevent accidental child entrapment or suffocation risk, do not remove the divider in the top freezer basket.

⚠ WARNING

To avoid electrical shock which can cause severe personal injury or death, disconnect power to refrigerator before removing doors. After replacing doors, connect power.

⚠ CAUTION

To avoid possible injury, product, or property damage, you will need two people to perform the following instructions.

To Remove:

1. Pull drawer open to full extension.
2. Pull upper basket out to full extension and lift out to remove.
3. Lift lower basket straight up and out to remove.

4. On each side rail is a basket cradle with two snap attachments. To release each cradle, unlatch the snaps by pushing them inward, away from the side rail system. Lift the cradles off of the rails.

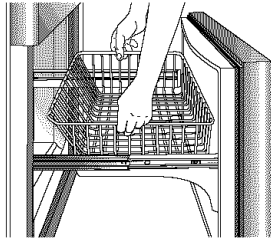

5. Remove Phillips screw from each side of rail system (select models).

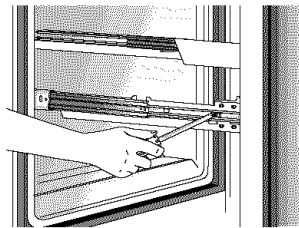

6. Lift top of drawer front to unhook supports from rail system. Lift door front out to remove.

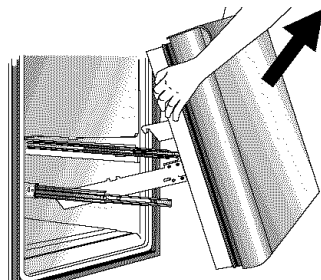

To Install:

1. Pull both rails out to full extension.

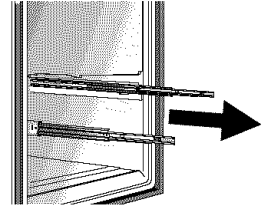

2. While supporting door front, hook supports into tabs located on inside of rail.

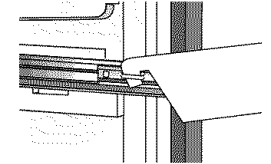

3. Lower door front into final position.

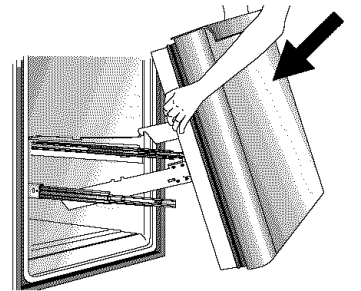

4. Replace and tighten Phillips screws that were removed from each side of rail system (select models).
5. Place the basket cradles back onto the side rails. Align snaps with the slots on the side rails and press each snap towards the rail until it clicks.
6. With rails pulled out to full extension, set the basket straight down into the basket cradles.

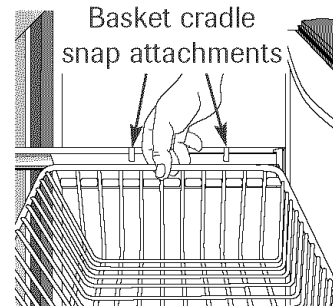

7. Slide upper basket into freezer. Make sure that rear of basket hooks behind rail catch.

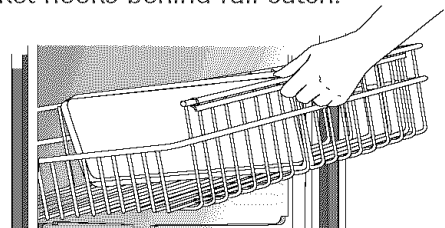



Installation

Reinstallation of the Doors

1. Install hinge assemblies:
 - Install top hinge loosely with $\frac{5}{16}$ " hex head screws.
 - Install center hinge with Phillips screws.
 - **Freezer door models:** Install bottom hinge with $\frac{3}{8}$ " hex head screws.

2. **Freezer door models:** Insert bottom hinge pin.

- Locate bottom hinge hole closest to outside edge of cabinet, and insert bottom hinge pin. Replace any door shims, if present.

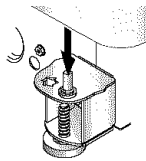

3. **Freezer door models:** Place hinge side of freezer door on bottom hinge pin and hold freezer door upright while installing center hinge pin with $\frac{5}{16}$ " hex head driver.

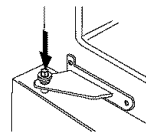

- Replace plastic sleeve.
- Replace any applicable door shims.
- Make sure the hinge pin is installed tightly.

4. Place hinge side of refrigerator door on center hinge pin.

5. While holding refrigerator door upright, tighten down top hinge with $\frac{5}{16}$ " hex head driver and replace hinge cover.

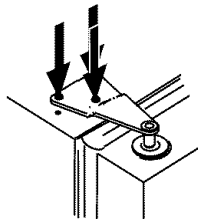

Door Reversal

In some installations, reversing the door swing allows for more convenient access to stored items. Both doors can be reversed on freezer *door* models and the fresh food door is reversible on freezer *drawer* models.

1. Remove door(s) (see page 4).
2. Transfer cabinet plugs and cabinet screws to opposite side of cabinet.
 - Remove cabinet plugs with flat blade of screwdriver tip wrapped in masking tape.
 - Remove center mullion screws with $\frac{5}{16}$ " hex head screwdriver.
 - **Freezer door models:** Remove bottom mullion screws with $\frac{3}{8}$ " hex head driver.

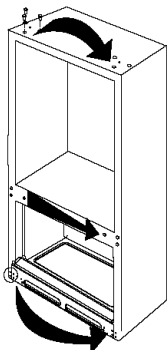

CAUTION

To avoid possible injury and damage to property:

- Place doors on a nonabrasive surface protected by towels or rugs while working directly on doors.

3. Transfer door stops from bottom edge of fresh food door and freezer door, if applicable, to opposite side of door edge.

- Use a Phillips screwdriver for removal and installation.

4. Install handles (see pages 6 and 7).

5. Reinstall the door(s).

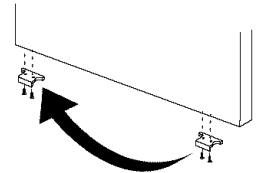

Handles

If not installed, the handle is located in the interior of the fresh food section or attached to the back of your refrigerator.

Remove and discard handle packaging and tape.

Handle design varies from refrigerator to refrigerator. Please reference the appropriate instructions for your model below.

Fresh Food Handles

Standard Front Mount Handle

Materials Needed

- Phillips screwdriver
- $\frac{5}{16}$ " hex head driver

To Install:

1. Remove $\frac{1}{4}$ " hex head screws from door face with hex head driver, and Phillips screw from top of door.

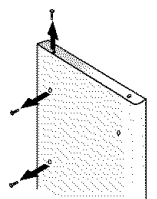

- If reversing door, remove door plugs from opposite side of door and insert in screw holes.

2. Align handle holes with screw holes on door face and secure with two door face screws from step 1.

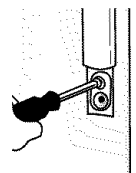

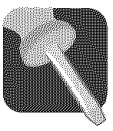

Installation

3. Locate handle trim in literature pack and install over top and bottom of handle, as illustrated.

- Secure top handle trim with remaining screw removed in step 1.
- Snap bottom trim over bottom portion of handle.

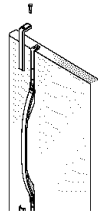

To Remove:

1. Remove top handle trim by removing top handle screw.

- Retain trim and screw for later replacement.

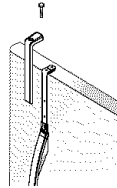

2. Pry bottom handle trim from handle with screwdriver flat blade wrapped in masking tape.

- Retain trim for later replacement.

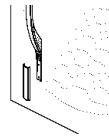

3. Remove two hex head screws.

- Retain screws for later replacement.

Side Mount Handle

Materials Needed

- Phillips screwdriver

To Install:

1. Remove screws from the side of the door.
2. Align the side mount handle with the predrilled holes in the door panel.
3. Insert the screws in the sequence as shown.

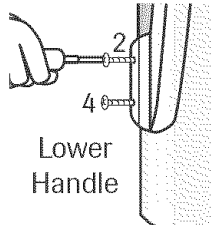
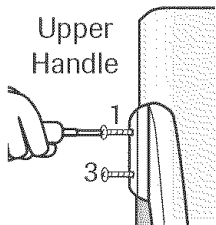
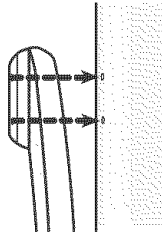

4. Ensure the door handle is snug to the door panel.

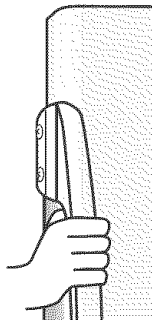

To Remove:

Reverse installation procedure.

Freezer Handles

Partial-Width Handle

Materials Needed

- Phillips screwdriver

To Install:

1. Install handle by fastening with screws removed from edge of door.

- If reversing freezer door, remove door plugs from top edge of door and insert into screw holes.

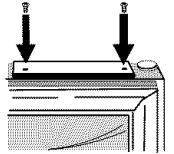

To Remove:

1. Remove handle screws with Phillips screwdriver and retain screws for later use.

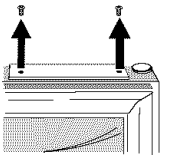

Front Mount Freezer Handle

Materials Needed

- Gloves to protect hands.
- Phillips screwdriver.
- Plastic handle removal card (or 1/32" thick plastic card). Retain the card.

Notes

- There is a slight curve to this style of freezer handle.
- For proper installation, be sure handle is oriented as shown.

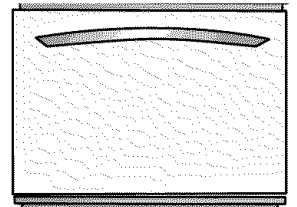

To Install:

1. Align door handle clips slightly to the left of the tabs attached to the freezer door.
2. Rotate the handle so the left base is flat against the door.

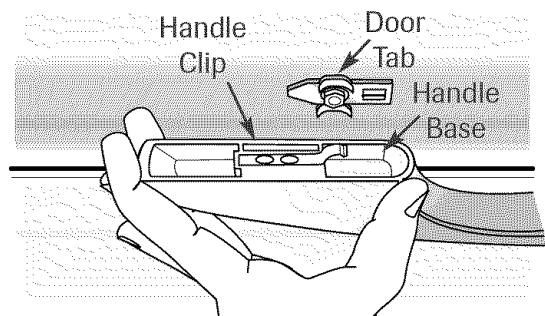

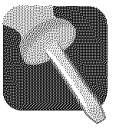

Installation

3. Push the left handle base against the left door tab and slightly to the right, just enough to allow it to hang unsupported.

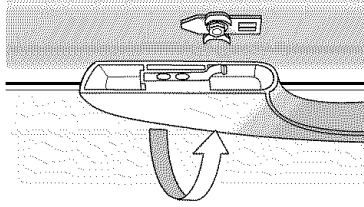

4. While firmly supporting the left handle base against the door, align the right base of the handle with the right tabs that are attached to the door.
5. Now, while firmly holding the handle at the left and right bases, gently slide the handle towards the right until the right base settles in. The handle should now be flat against the face of the freezer door at both the left and right bases.
6. With hands still firmly keeping the handle flat against the freezer door, you may have to reverse directions momentarily to assure clip/tab engagement. Then firmly slide the handle to the right until it clicks. The audible "click" indicates that the fastening clips are securely interlocked.

To Remove:

1. At the right end, flex the handle base away from the surface of the freezer drawer. Simultaneously slide the door handle removal card that came with your refrigerator under the right side base of the handle. Slide the card to the line indication or until it stops, which will be approximately 1½".
2. With both hands, firmly grasp the handle towards the right base.
3. Slide towards the left, lift and remove from the surface.

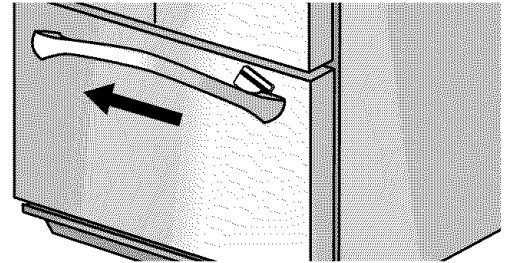

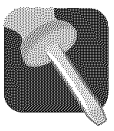

Installation

Connecting the Water Supply (select models)

⚠ WARNING

To reduce the risk of injury or death, follow basic precautions, including the following:

- Read all instructions before installing ice maker.
- Do not attempt installation if instructions are not understood or if they are beyond personal skill level.
- Observe all local codes and ordinances.
- Do not service ice maker unless specifically recommended in Use & Care Guide or published user-repair instructions.
- Disconnect power to refrigerator before installing ice maker.
- Water damage due to an improper water connection may cause mold/mildew growth. Clean up spills or leakage immediately.

⚠ CAUTION

To avoid property damage or possible injury, follow basic precautions, including the following:

- Consult a plumber to connect **1/4" O.D. copper tubing** to household plumbing to assure compliance with local codes and ordinances.
- Confirm water pressure to water valve is between 35 and 100 pounds per square inch. 20 pounds per square inch if there is not a water filter.
- Do not use a self-piercing, or 3/16" saddle valve. Both reduce water flow and can become clogged over time, and may cause leaks if repair is attempted.
- Tighten nuts by hand to prevent cross threading. Finish tightening nuts with pliers and wrenches. Do not overtighten.
- Wait 2-3 hours before placing refrigerator into final position to check and correct any water leaks. Recheck for leaks after 24 hours.
- Verify the copper tubing under the sleeve is smooth and free from defects. Do not reuse an old sleeve.

Materials Needed

- 1/4" outer diameter flexible copper tubing
- Shut-off valve (requires a 1/4" hole to be drilled into water supply line before valve attachment)
- Adjustable wrench
- 1/4" hex nut driver

Note

- Add 8' to tubing length needed to reach water supply for creation of service loop.

1. Create service loop with copper tubing (minimum 2' diameter). Avoid kinks in the copper tubing when bending it into a service loop.

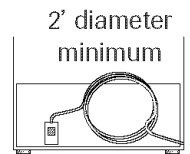

2. Remove plastic cap from water valve inlet port.



3. Place brass nut (A) and sleeve (B) on copper tube end as illustrated.

Reminder: Do not use an old sleeve.

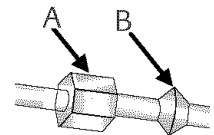

4. Place end of copper tubing into water valve inlet port. Shape tubing slightly. Do not kink – so that tubing feeds straight into inlet port.

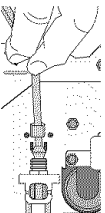

5. Slide brass nut over sleeve and screw nut into inlet port. Tighten nut with wrench.

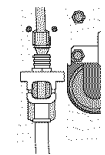

IMPORTANT: Do not overtighten. Cross threading may occur.

6. Pull on tubing to confirm connection is secure. Connect tubing to frame with water tubing clamp (C) and turn on water supply. Check for leaks and correct if necessary. Continue to observe the water supply connection for two to three hours prior to moving the refrigerator to its permanent location.

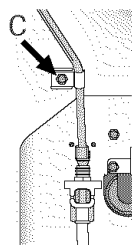

7. Monitor water connection for 24 hours. Correct leaks, if necessary.



Temperature Controls

Dial Temperature Controls (select models)

The controls are located at the top front of the refrigerator and freezer compartments.

Note

- The freezer control turns the cooling system on. Neither section will cool if freezer control is set to OFF.

Refrigerator Control

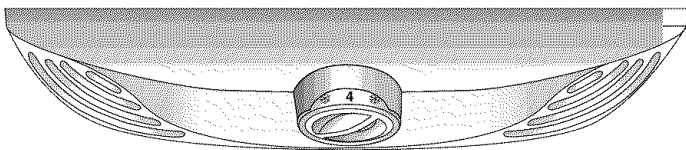

Freezer Control

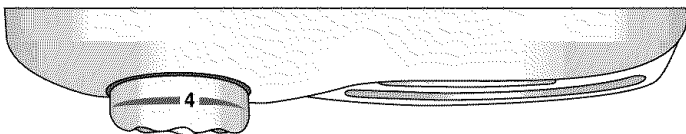

Initial Control Settings

After plugging the refrigerator in, set the controls.

- To adjust the controls, turn the control knob to the left or right as desired.
- The temperature control range for both compartments is 1 through 7 (coldest).
- Set the freezer control on 4.
- Set the refrigerator control on 4.
- Let the refrigerator run at least 8 to 12 hours before adding food.

Warm Cabinet Surfaces

At times, the front of the refrigerator cabinet may be warm to the touch. This is a normal occurrence that helps prevent moisture from condensing on the cabinet. This condition will be more noticeable when you first start the refrigerator, during hot weather and after excessive or lengthy door openings.

Adjusting the Controls

- 24 hours after adding food, you may decide that one or both compartments should be colder or warmer. If so, adjust the control(s) as indicated in the *Temperature Control Guide* table below. See page 18 for instructions on checking compartment temperature.
- Except when starting the refrigerator, do not change either control more than one number at a time.
- Allow 24 hours for temperatures to stabilize.
- Changing either control will have some effect on the temperature of the other compartment.

Temperature Control Guide

Refrigerator too warm	Turn the refrigerator control to next higher number.
Refrigerator too cold	Turn the refrigerator control to next lower number.
Freezer too warm	Turn the freezer control to next higher number.
Freezer too cold	Turn the freezer control to next lower number.
Turn refrigerator OFF	Turn the freezer control to OFF.

Note

- Turning freezer control to OFF stops cooling in both compartments. It does not shut off power to the refrigerator.



Temperature Controls

Touch Temperature Controls (select models)

The controls are located at the top front of the refrigerator compartment.

Control

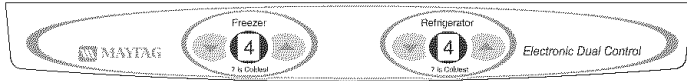

Initial Control Settings

After plugging the refrigerator in, set the controls.

- Pressing the or pads adjusts the controls to the desired setting.
- The temperature control range for both compartments is 1 through 7 (coldest).
- Set the freezer control on 4.
- Set the refrigerator control on 4.
- Let the refrigerator run at least 8 to 12 hours before adding food.

Warm Cabinet Surfaces

At times, the front of the refrigerator cabinet may be warm to the touch. This is a normal occurrence that helps prevent moisture from condensing on the cabinet. This condition will be more noticeable when you first start the refrigerator, during hot weather and after excessive or lengthy door openings.

Adjusting the Controls

- 24 hours after adding food, you may decide that one or both compartments should be colder or warmer. If so, adjust the control(s) as indicated in the *Temperature Control Guide* table below. See page 18 for instructions on checking compartment temperature.
- Except when starting the refrigerator, do not change either control more than one number at a time.
- Allow 24 hours for temperatures to stabilize.

Temperature Control Guide

Refrigerator too warm	Set the refrigerator control to next higher number by pressing the pad.
Refrigerator too cold	Set the refrigerator control to next lower number by pressing the pad.
Freezer too warm	Set the freezer control to next higher number by pressing the pad.
Freezer too cold	Set the freezer control to next lower number by pressing the pad.
Turn refrigerator OFF	Press the refrigerator or freezer pad until a dash (–) appears in the display.



Fresh Food Features

Shelves

⚠ CAUTION

To avoid personal injury or property damage, observe the following:

- Never attempt to adjust a shelf that is loaded with food (except in the case of the Elevator™ shelf).
- Confirm shelf is secure before placing items on shelf.
- Handle tempered glass shelves carefully. Shelves may break suddenly if nicked, scratched, or exposed to sudden temperature change.

Your refrigerator has either **Spill-Catcher™** or **non-sealed Shelves**. The Spill-Catcher™ shelves have a spill retainer edge which allows for easier clean up and some are equipped with the **Easy Glide** slide out feature. To slide out (select models), grasp the front of the shelf and pull forward. Push in the shelf to return to the original position.

To Remove a Shelf:

- Slightly tilt up the front and lift up the rear of the shelf, then pull the shelf straight out.

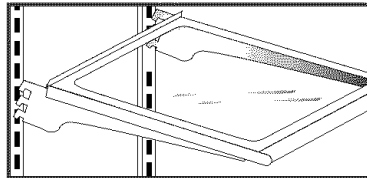

To Lock the Shelf Into Another Position:

- Tilt up the front edge of the shelf.
- Insert the hooks into the desired frame openings and let the shelf settle into place.
- Be sure the shelf is securely locked at the rear.

Elevator™ Shelf

The fresh food compartment is equipped with an **Elevator™** shelf.

This shelf can be adjusted up or down without having to be unloaded of its contents. To adjust an Elevator™ shelf, pull out the knob on the crank handle. Rotate the crank clockwise to raise the height of the shelf, and counterclockwise to lower the height of the shelf.

Note

- Do not raise the shelf to the very top of the vertical rails, as the shelf may become jammed.

To Remove:

Completely unload the shelf and pull the shelf forward. When the shelf stops, press up on the tabs located underneath its outside edges, then continue pulling forward, clear of the frame.

To Install:

Align the shelf to the frame and push it all the way back. (There is no need to depress the tabs for reinstallation).

In ordinary use, the Elevator™ shelf frame assembly **does not** require removal. Though unlikely, and not recommended, the correct removal procedure is as follows:

To Remove:

- Unload the shelf completely.
- Remove glass shelf by pulling forward. When shelf stops lift up and continue pulling forward.
- Manually move the two rear latches toward the shelf center.
- While supporting the entire shelf and frame from underneath, lift slightly and rotate the assembly approximately 30° to allow the rear mechanism to clear the vertical rear side rails.
- The entire assembly can then be moved forward and clear of the refrigerator compartment.

To Install:

- Reverse the removal procedure. Be sure the shelf is in a level position.
- When the sliding shelf is pushed to the rear, it will reposition the rear latches to their correct operating position.

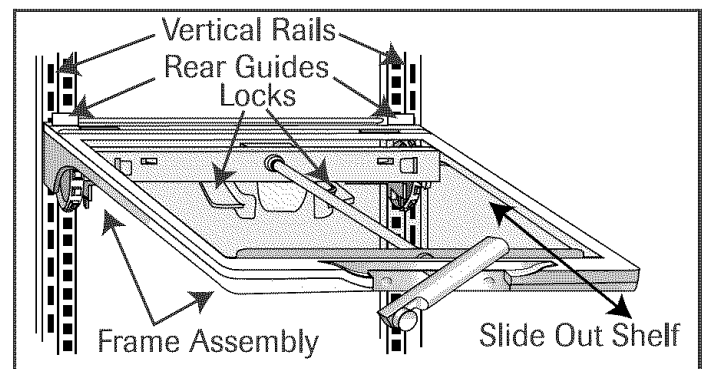



Fresh Food Features

The **Crisper Top** serves as the lower fresh food shelf.

To Remove the Crisper Top:

- Remove crisper drawers as indicated on page 14.
- Place hand under the frame to push up the glass. Lift glass out.
- Lift frame from refrigerator liner rails.

To Install:

- Repeat above instructions in reverse order.

Door Storage

Dairy Compartment

The **Dairy Compartment** provides convenient door storage for spreadable items such as butter and margarine. This compartment can be moved to different locations to accommodate storage needs. To use the dairy compartment, raise the cover.

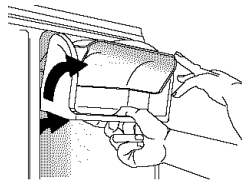

To Remove:

- Raise the cover, pull upward and tilt out.

To Install:

- Reverse above procedure.

Door Buckets

Door Buckets can be moved to meet storage needs.

To Remove:

- Slide bucket up and pull straight out.

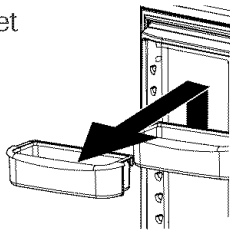

To Install:

- Slide bucket in and down until firmly seated in the door liner.

Full-width Door Shelf

Full-width Door Shelf removes for easy cleaning.

To Remove:

- Slide shelf up and pull straight out.

To Install:

- Reverse above procedure.

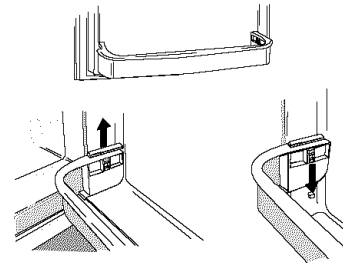

Storage Drawers

Snack Drawer (select models)

The **Snack Drawer** can be used for storage of miscellaneous items or extra produce.

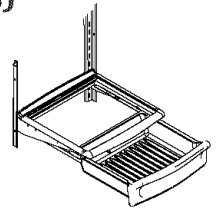

To Remove:

- Pull drawer out to full extension. Tilt up front of drawer and pull straight out.

To Install:

- Insert drawer into frame rails and push back into place.



Fresh Food Features

Humidity-Controlled Crisper Drawers

The **Crisper Drawers** provide a higher humidity environment for fresh fruit and vegetable storage.

Controls

The **Crisper Controls** regulate the amount of humidity in the crisper drawer. Slide the control towards the **fruit** setting when storing produce with outer skins. Slide the control towards the **vegetable** setting when storing leafy produce.



To Remove:

- Pull drawer out to full extension. Tilt up front of drawer and pull straight out.

To Install:

- Insert drawer into frame rails and push back into place.



Note

- For best results, keep the crisper drawers tightly closed.

Temperature-Controlled Drawer (select models)

The **Wide-N-Fresh™** deli drawer is a full-width drawer with adjustable temperature control. This drawer can be used for large party trays, deli items, beverages or miscellaneous items.

There is a temperature control which adjusts the amount of cold air allowed into the drawer. The control is located on the right side of the drawer. Depending on your model, it is either on the front of the drawer or under the lid.

Set the control to **cheese** or  to provide a normal refrigerator temperature. Set the drawer on the **meats** or  setting when a temperature colder than the main refrigerator compartment is desired. Use the coldest setting when storing meats.

Notes

- Cold air directed to the drawer can decrease refrigerator temperature. Refrigerator control may need to be adjusted.
- Do not place leafy vegetables in the drawer. Colder temperatures could damage leafy produce.

To Remove:

- Lift lid (select models). Pull drawer out to full extension. Tilt up front of pantry and pull straight out.

To Install:

- Push metal glide rails to the back of the refrigerator (select models). Place drawer onto rails and slide drawer back until it falls into place.

Some models feature a divider to organize the drawer into sections.

To Remove:

- Pull drawer completely out and raise the front of the divider to unhook it from the rear wall of the drawer and lift it out.

To Install:

- Hook back of divider over rear wall of the drawer and lower into place.



Fresh Food Features

Can Rack (select models)

The **Can Rack** slides out from underneath the Spill-Catcher™ shelf. It holds up to twelve 12-ounce beverage cans.

To Remove:

- Pull rack out to full extension. Tilt up the front of rack and pull straight out.

To Install:

- Insert rack into frame rails and push back into place.

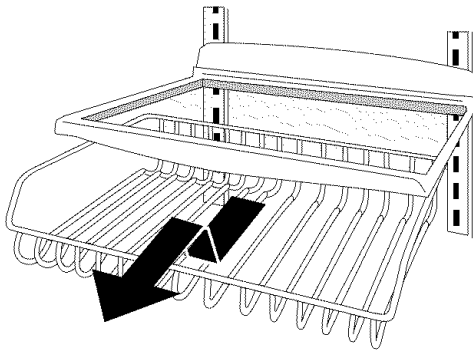

Accessories

Wine Trivet/Can Rack (select models)

The **Wine Trivet/Can Rack** accessory fits in the **Wide-N-Fresh™** deli drawer or on a shelf.

Bottles or cans can be laid crosswise, or a single bottle may be laid in the center depression.

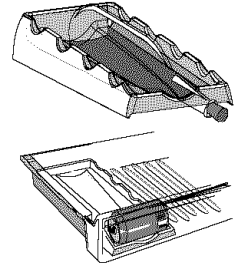

Wine Rack (select models)

The **Wine Rack** provides a place for horizontally storing wine. The rack can also hold an egg carton.

Position the rack to rest on the left hand side of a refrigerator shelf (this rack cannot be positioned on an Elevator™ shelf).

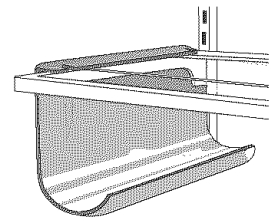

Egg Cradle

The **Egg Cradle** (style may vary/select models) holds a “dozen-plus” eggs. It can be removed to carry to work area or to be washed.

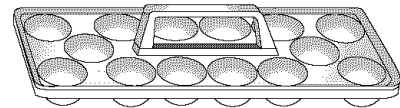



Freezer Features

Automatic Ice Maker (select models)

Note

- Energy rating guides that are posted on the refrigerator at the time of purchase do not include optional ice maker energy usage.

Some models are automatic ice maker ready. The number of the appropriate ice maker kit is IC11B. The kit contains installation instructions and water connection instructions.

Other models have a factory installed ice maker. Connect the ice maker to the water supply as instructed on page 9. **Proper water flow and a level refrigerator are essential for optimal ice maker performance.**

Operating Instructions

- Confirm ice bin is in place and ice maker arm is down.
- After freezer section reaches approximately 0° F (-18° C), ice maker fills with water and begins operating. You will have a complete harvest of ice approximately every three hours.
- Allow approximately 24 hours after installation to receive first harvest of ice.
- Discard ice created within first 12 hours of operation to verify system is flushed of impurities.
- Stop ice production by raising ice maker arm until click is heard.
- Ice maker will remain in the off position until arm is pushed down.
- The first one or two batches will probably contain undersized and irregular cubes because of air in the supply line.
- When the ice cubes are ejected it is normal for several cubes to be joined together at the ends. They can easily be broken apart. The ice maker will continue to make ice until the supply of ice cubes raises the sensor arm, shutting the ice maker off.
- Certain sounds may accompany the various cycles of the ice maker. The motor may have a slight hum, the

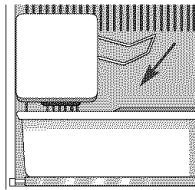

cubes will rattle as they fall into an empty storage pan and the water valve may click or “buzz” occasionally.

- If the ice is not used frequently, the ice cubes will become cloudy, shrink, stick together and taste stale. Empty the ice storage bin periodically and wash it in lukewarm water. Be sure to dry the bin thoroughly before replacing it.
- Beverages and foods should not be placed in the ice storage bin for quick chilling. These items can block the sensor arm, causing the ice maker to malfunction.
- Turn off (arm up) the ice maker when the water supply is to be shut off for several hours.

To Remove the Ice Bin:

- Pull it forward, away from the ice maker. To avoid the ice maker dumping ice while the bin is removed, turn the ice maker off by raising the sensor arm.

To Install the Ice Bin:

- Reverse the above procedure. Turn the ice maker on by lowering the sensor arm.

⚠ WARNING

To avoid personal injury or property damage, observe the following:

- Do not place fingers or hands on the automatic ice making mechanism while the refrigerator is plugged in. This will help protect you from possible injury. It will also prevent interference with moving parts of the ejector mechanism and the heating element that releases the cubes.
- Under certain rare circumstances, ice cubes may be discolored, usually appearing with a green-bluish hue. The cause of this unusual discoloration can be a combination of factors such as certain characteristics of local waters, household plumbing and the accumulation of copper salts in an inactive water supply line which feeds the ice maker. Continued consumption of such discolored ice cubes may be injurious to health. If such discoloration is observed, discard the ice cubes and contact your dealer to purchase and install a water line filter.
- Water damage due to improper water connection may cause mold/mildew growth.
- Clean up water and ice spills to avoid personal injury and to prevent mold/mildew growth.



Freezer Features

Shelves and Baskets

Models with swing freezer door:

Freezer Shelf (select models)

Select models have a shelf divider.

To Remove:

- Pull shelf out to full extension. Tilt up front of shelf and pull straight out.

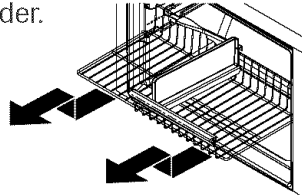

To Install:

- Insert shelf into freezer liner rails and push to back of compartment.

Wire Basket (select models)

To Remove:

- Pull basket out to full extension. Tilt up front of basket and pull straight out.

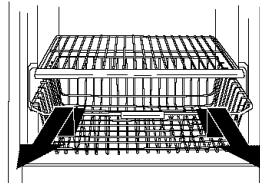

To Install:

- Insert basket into freezer liner rails and push back into place.

Freezer Door Shelf (select models)

The **Freezer Door Shelf** provides convenient storage for frozen food items in freezer door.

To Remove:

- Lift shelf from side liner tabs and pull out.

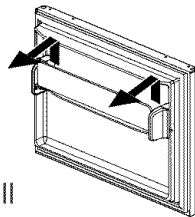

To Install:

- Fit ends of shelf on liner tabs and slide down.

Models with pullout freezer drawer:

⚠ DANGER

To prevent accidental child entrapment or suffocation risk, do not remove the divider in the top freezer basket.

Upper Wire Basket

To Remove:

- Pull upper basket out to full extension and lift out to remove.

To Install:

- Slide upper basket into freezer. Make sure that rear of basket hooks behind rail catch.

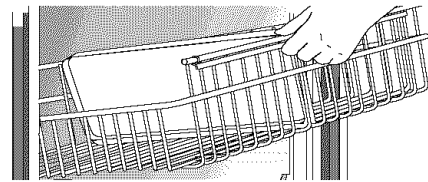

Note

- **Freezer Drawer Models:** See page 5 for lower basket and complete pullout drawer instructions.

Accessories

Ice Cube Tray (select models)

The **Ice Cube Tray** provides an area to freeze cubes for manual dispensing of ice.

To release ice cubes from tray, hold tray upside down over a storage container and twist both ends of tray until cubes release.

The **Ice Service Rack** (select models) holds the ice cube tray.

To Install:

- Slide L-shaped groove of shelf down over back wall screw. Push rack back until screw is stopped in L-shaped groove (1). Slide front portion of shelf over front wall screw (2).

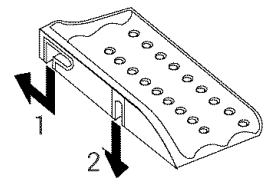

To Remove:

- Perform above steps in reverse order.



Food Storage Tips

Fresh Food Storage

- The fresh food compartment of a refrigerator should be kept between 34° and 40° F (1° and 4° C) with an optimum temperature of 37° F (3° C). To check the temperature, place an appliance thermometer in a glass of water and place in the center of the refrigerator. Check after 24 hours. If the temperature is above 40° F (4° C) adjust the controls as explained on pages 10 and 11.
- Avoid overcrowding the refrigerator shelves. This reduces the circulation of air around the food and results in uneven cooling.

Fruits and Vegetables

- The crisper drawers trap humidity to help preserve the fruit and vegetable quality for longer time periods see page 14.
- Sort fruits and vegetables before storage and use bruised or soft items first. Discard those showing signs of decay.
- Always wrap odorous foods such as onions and cabbage so the odor does not transfer to other foods.
- While vegetables need a certain amount of humidity to remain fresh, too much humidity can shorten storage times (especially leafy vegetables). Drain vegetables well before storing.
- Wait to wash fresh produce until right before use.

Meat and Cheese

- Raw meat and poultry should be wrapped securely so leakage and contamination of other foods or surfaces does not occur.
- Occasionally mold will develop on the surface of hard cheeses (Swiss, Cheddar, Parmesan). Cut off at least an inch around and below the moldy area. Keep your knife or instrument out of the mold itself. Do not try to save individual cheese slices, soft cheese, cottage cheese, cream, sour cream or yogurt when mold appears.

Dairy Food

- Most dairy foods such as milk, yogurt, sour cream and cottage cheese have freshness dates on their cartons for appropriate length of storage. Store these foods in the original carton and refrigerate immediately after purchasing and after each use.

Frozen Food Storage

- The freezer compartment of a refrigerator should be kept at approximately 0° F (-18° C). To check the temperature, place an appliance thermometer between the frozen packages and check after 24 hours. If the temperature is above 0° F (-18° C), adjust the control as described on pages 10 and 11.
- A freezer operates more efficiently when it is at least two-thirds full.

Packaging Foods for Freezing

- To minimize dehydration and quality deterioration use aluminum foil, freezer wrap, freezer bags or airtight containers. Force as much air out of the packages as possible and be sure they are tightly sealed. Trapped air can cause the food to dry out, change color and develop an off-flavor (freezer burn).
- Overwrap fresh meats and poultry with suitable freezer wrap prior to freezing.
- Do not refreeze meat that has completely thawed.

Loading the Freezer

- Avoid adding too much warm food to the freezer at one time. This overloads the freezer, slows the rate of freezing and can raise the temperature of frozen foods.
- Leave space between the packages so cold air can circulate freely, allowing food to freeze as quickly as possible.
- Avoid storing hard-to-freeze foods such as ice cream and orange juice on the freezer door shelves. These foods are best stored in the freezer interior where the temperature varies less with door openings.

Refer to the *Food Storage Chart* on pages 19 and 20 for approximate storage times.



Food Storage Tips

Food Storage Chart

Storage times are approximate and may vary depending on type of packaging, storage temperature, and the quality of the food when purchased.

FOODS	REFRIGERATOR	FREEZER	STORAGE TIPS
DAIRY PRODUCTS			
Butter	1 month	6 to 9 months	Wrap tightly or cover.
Milk and cream	1 week	Not recommended	Check carton date. Close tightly. Don't return unused portions to original container. Don't freeze cream unless whipped.
Cream cheese, cheese spread and cheese food	1 to 2 weeks	Not recommended	Wrap tightly.
Cottage cheese	3 to 5 days	Not recommended	Store in original carton. Check carton date.
Sour cream	10 days	Not recommended	Store in original carton. Check carton date.
Hard cheese (Swiss, Cheddar and Parmesan)	1 to 2 months	4 to 6 months May become crumbly	Wrap tightly. Cut off any mold.
EGGS			
Eggs in the shell	3 weeks	Not recommended	Refrigerate small ends down.
Leftover yolks or whites	2 to 4 days	9 to 12 months	For each cup of yolks to be frozen, add 1 tsp. sugar for use in sweet, or 1 tsp. salt for non-sweet dishes.
FRUITS			
Apples	1 month	8 months (cooked)	May also store unripe or hard apples at 60° to 70° F (16° to 21° C).
Bananas	2 to 4 days	6 months (whole/peeled)	Ripen at room temperature before refrigerating. Bananas darken when refrigerated.
Pears, plums, avocados	3 to 4 days	Not recommended	Ripen at room temperature before refrigerating. Avocados darken when refrigerated.
Berries, cherries, apricots	2 to 3 days	6 months	Ripen at room temperature before refrigerating.
Grapes	3 to 5 days	1 month (whole)	Ripen at room temperature before refrigerating.
Citrus fruits	1 to 2 weeks	Not recommended	May also store at 60° to 70° F (16° to 21° C). If refrigerated, store uncovered.
Pineapples, cut	2 to 3 days	6 to 12 months	Will not ripen after purchase. Use quickly.



Food Storage Tips

FOODS	REFRIGERATOR	FREEZER	STORAGE TIPS
VEGETABLES			
Asparagus	1 to 2 days	8 to 10 months	Do not wash before refrigerating. Store in crisper.
Brussels sprouts, broccoli, cauliflower, green peas, lima beans, onions, peppers	3 to 5 days	8 to 10 months	Wrap odorous foods. Leave peas in pods.
Cabbage, celery	1 to 2 weeks	Not recommended	Wrap odorous foods and refrigerate in crisper.
Carrots, parsnips, beets and turnips	7 to 10 days	8 to 10 months	Remove tops. Wrap odorous foods and refrigerate in the crisper.
Lettuce	7 to 10 days	Not recommended	
POULTRY and FISH			
Chicken and Turkey, whole	1 to 2 days	12 months	Keep in original packaging for refrigeration. Place in the meat and cheese drawer. When freezing longer than two weeks, overwrap with freezer wrap.
Chicken and Turkey, pieces	1 to 2 days	9 months	
Fish	1 to 2 days	2 to 6 months	
MEATS			
Bacon	7 days	1 month	
Beef or lamb, ground	1 to 2 days	3 to 4 months	Fresh meats can be kept in original packaging for refrigeration.
Beef or lamb, roast and steak	3 to 5 days	6 to 9 months	Place in the meat and cheese drawer. When freezing longer than two weeks, overwrap with freezer wrap.
Ham, fully cooked, whole	7 days	1 to 2 months	
half	5 days	1 to 2 months	
slices	3 days	1 to 2 months	
Luncheon meat	3 to 5 days	1 to 2 months	Unopened, vacuum-packed luncheon meat may be kept up to two weeks in the meat and cheese drawer.
Pork, roast	3 to 5 days	4 to 6 months	
Pork, chops	3 to 5 days	4 months	
Sausage, ground	1 to 2 days	1 to 2 months	
Sausage, smoked	7 days	1 to 2 months	
Veal	3 to 5 days	4 to 6 months	
Frankfurters	7 days	1 month	Processed meats should be tightly wrapped and stored in the meat and cheese drawer.

Sources: United States Department of Agriculture; Food Marketing Institute; Cooperative Extension Service, Iowa State University



Care and Cleaning

⚠ WARNING

To avoid electrical shock which can cause severe personal injury or death, disconnect power to refrigerator before cleaning. After cleaning, connect power.

⚠ CAUTION

To avoid personal injury or property damage, observe the following:

- Read and follow manufacturer's directions for all cleaning products.
- Do not place buckets, shelves or accessories in dishwasher. Cracking or warping of accessories may result.

Refrigerator Cleaning Chart

PART	DO NOT USE	DO
Textured Doors and Exterior	Abrasive or harsh cleaners Ammonia Chlorine bleach Concentrated detergents or solvents Metal or plastic-textured scouring pads	Use 4 tablespoons of baking soda dissolved in 1 quart (1 liter) warm soapy water. Rinse surfaces with clean warm water and dry immediately to avoid water spots.
Cabinet Interior		
Stainless Steel Doors and Exterior (select models) IMPORTANT: <i>Damage to stainless steel finish due to improper use of cleaning products or non-recommended products is not covered under this product's warranty.</i>	Abrasive or harsh cleaners Ammonia Chlorine bleach Concentrated detergents or solvents Metal or plastic-textured scouring pads Vinegar-based products Citrus-based cleaners	Use warm, soapy water and a soft, clean cloth or sponge. Rinse surfaces with clean warm water and dry immediately to avoid water spots. To polish and help prevent finger prints, follow with Stainless Steel Magic Spray (part no. 20000008*).
Door Gaskets	Abrasive or harsh cleaners Metal or plastic-textured scouring pads	Use warm, soapy water and a soft, clean cloth or sponge.
Condenser Coil <i>Remove base grille to access.</i>		Use a vacuum cleaner hose nozzle.
Condenser Fan Outlet Grille <i>See back of refrigerator.</i>		Use a vacuum cleaner hose nozzle with brush attachment.
Accessories <i>Shelves, buckets, drawers, etc.</i>	A dishwasher	Follow removal and installation instructions from appropriate feature section. Allow accessories to adjust to room temperature. Dilute mild detergent and use a soft clean cloth or sponge for cleaning. Use a plastic bristle brush to get into crevices. Rinse surfaces with clean warm water. Dry glass and clear items immediately to avoid spots.

* To order, call 1-877-232-6771 U.S.A. or 1-800-688-8408 Canada.



Care and Cleaning

Removing Odors From Refrigerator

⚠ WARNING

To avoid electrical shock which can cause severe personal injury or death, disconnect power to refrigerator before cleaning. After cleaning, reconnect power.

1. Remove all food and turn the refrigerator OFF.
2. Disconnect power to the refrigerator.
3. Clean the walls, floor, ceiling of cabinet interior, drawers, shelves and gaskets according to the instructions on page 21.
4. Dilute mild detergent and brush solution into crevices using a plastic bristle brush. Let stand for five minutes. Rinse surfaces with warm water. Dry surfaces with a soft, clean cloth.
5. Wash and dry all bottles, containers and jars. Discard spoiled or expired items.
6. Wrap or store odor-causing foods in tightly sealed containers to prevent recurring odors.
7. Reconnect power to refrigerator and return food to refrigerator.
8. Allow the refrigerator to cool.
9. After 24 hours, check if odor has been eliminated.

If odor is still present:

1. Remove drawers and place on top shelf of refrigerator.
2. Pack refrigerator and freezer sections – including doors – with crumpled sheets of black and white newspaper.
3. Place charcoal briquettes randomly on crumpled newspaper in both freezer and refrigerator compartments.
4. Close doors and let stand 24 to 48 hours.

Energy Saving Tips

- Avoid overcrowding refrigerator shelves. This reduces air circulation around food and causes refrigerator to run longer.
- Avoid adding too much warm food to refrigerator at one time. This overloads compartments and slows rate of cooling.
- Do not use aluminum foil, wax paper, or paper toweling as shelf liners. This decreases air flow and causes refrigerator to run less efficiently.
- A freezer that is two-thirds full runs most efficiently.
- Locate refrigerator in coolest part of room. Avoid areas of direct sunlight, or near heating ducts, registers or other heat producing appliances. If this is not possible, isolate exterior by using a section of cabinet.
- Clean door gaskets every three months according to cleaning instructions. This will assure that door seals properly and refrigerator runs efficiently.
- Take time to organize items in refrigerator to reduce time that door is open.
- Be sure your doors are closing securely by leveling refrigerator as instructed in your installation instructions.
- Clean condenser coils as indicated in the cleaning instructions every three months. This will increase energy efficiency and cooling performance.



Care and Cleaning

Replacing Light Bulbs

⚠ WARNING

To avoid electrical shock which can cause severe personal injury or death, disconnect power to refrigerator before replacing light bulb. After replacing light bulb, reconnect power.

⚠ CAUTION

To avoid personal injury or property damage, observe the following:

- Allow light bulb to cool.
- Wear gloves when replacing light bulb.

Fresh Food Section (style of light shield varies)

1. Slide clear light shield toward back of compartment to release from light assembly.
2. Remove light bulbs.
3. Replace with appliance bulbs **no greater than 40 watts**.
4. Replace light bulb cover by inserting tabs on light shield into liner holes on each side of light assembly. Slide shield toward front of refrigerator until it locks into place. Do not force shield beyond locking point. Doing so may damage light shield.

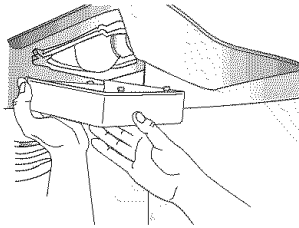

Freezer (style of light shield varies)

1. Reach behind the light cover.
2. With firm pressure, press forward on the notches at the back of the cover and pull down. The cover will open from the back.
3. Remove the cover.
4. Remove light bulb.
5. Replace bulb with appliance bulb **no greater than 40 watts**.
6. Insert front tabs of light cover into slots in freezer liner and snap rear portion over light assembly until rear tab engages.

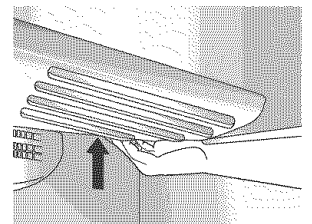
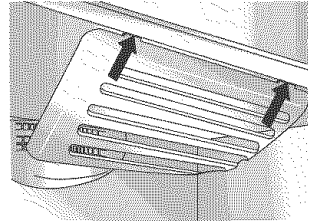
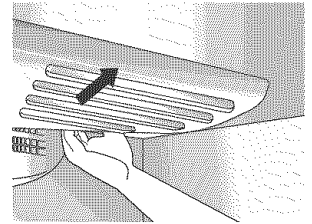



Care and Cleaning

Preparing for Vacation

⚠ CAUTION

If your refrigerator has a dispenser and there is any possibility that the temperature can drop below freezing where the refrigerator is located, the water supply system (including the water tank and the water valve) must be drained by a qualified servicer.

For short vacations or absences (three months or less):

1. Remove all perishables.
2. If no one will be checking in on the refrigerator during your absence, remove all frozen items also.
3. If your refrigerator has an automatic ice maker:
 - Shut off the water supply to the ice maker at least one day ahead of time.
 - After the last load of ice drops, raise the wire shut off arm to the OFF position.
 - Empty the ice bin.
4. If the room temperature will drop below 55° F (13° C), follow the instructions for longer absences.

For long vacations, absences (more than three months) OR if the room temperature will drop below 55° F (13° C):

1. Remove food.
2. If your refrigerator has an automatic ice maker:
 - Shut off the water supply to the ice maker at least one day ahead of time.
 - After the last load of ice drops, raise the wire shut off arm to the OFF position.
 - Empty the ice bin.
3. Turn the freezer control to (OFF) with dial controls or (–) with touch controls (see page 10 or 11).
4. Unplug the refrigerator.
5. Thoroughly clean the interior of both compartments with a baking soda solution and a clean soft cloth (four tablespoons of baking soda in one quart of warm water).
6. Dry thoroughly.
7. Leave the doors open to prevent the formation of mold and mildew.

Upon your return:

After a short vacation or absence:

For models with automatic ice makers:

- Reconnect the water supply and turn on supply valve (see page 9).
- Monitor water connection for 24 hours and correct leaks if necessary.
- Restart the ice maker.
- Discard at least the first three ice harvests.

After a long vacation or absence:

- If your refrigerator has an automatic ice maker, reconnect the water supply and turn on supply valve (see page 9).
- Plug the refrigerator back in and reset controls (see pages 10 and 11).
- Monitor water connection for 24 hours and correct leaks, if necessary.
- Restart the ice maker.
- Discard ice produced within the first 12 hours (at least the first three harvests).

Preparing to move:

- Follow the above instructions for long vacations/absences, through step 6.
- Secure all loose items such as shelves and drawers by taping them securely in place to prevent damage.
- Tape the doors shut.
- Use an appliance dolly when moving the refrigerator. Always truck the refrigerator from its side or back—never from its front.
- Be sure the refrigerator stays in an upright position during moving.

Operating Sounds

Improvements in refrigeration design may produce sounds in your new refrigerator that are different or were not present in an older model. These improvements were made to create a refrigerator that is better at preserving food, is more energy efficient, and is quieter overall. Because new refrigerators run quieter, sounds may be detected that were present in older refrigerators, but were masked by higher sound levels. Many of these sounds are normal. Please note that the surfaces adjacent to a refrigerator, such as hard walls, floors and cabinetry may make these sounds seem even louder. The following are some of the normal sounds that may be noticed in a new refrigerator.

SOUND	POSSIBLE CAUSE	SOLUTION
Clicking	• Freezer control (A) clicks when starting or stopping compressor.	• Normal operation
	• Motorized device (B) sounds like an electric clock and snaps in and out.	• Normal operation
Air rushing or whirring	• Freezer fan (C) and condenser fan (D) make this noise while operating.	• Normal operation
Gurgling or boiling sound	• Evaporator (E) and heat exchanger (F) refrigerant makes this noise when flowing.	• Normal operation
Thumping	• Ice cubes from ice maker (select models) drop into ice bucket (G) .	• Normal operation
Vibrating noise	• Compressor (H) makes a pulsating sound while running.	• Normal operation
	• Refrigerator is not level.	• See page 3 for details on how to level your refrigerator.
Buzzing	• Ice maker water valve (I) hookup (select models) buzzes when ice maker fills with water.	• Normal operation
Humming	• Ice maker (J) is in the 'on' position without water connection.	• Stop sound by raising ice maker arm to OFF position (see page 16).
	• Compressor (H) can make a high-pitched hum while operating.	• Normal operation
Hissing or popping	• Defrost heater (K) hisses, sizzles or pops when operational.	• Normal operation

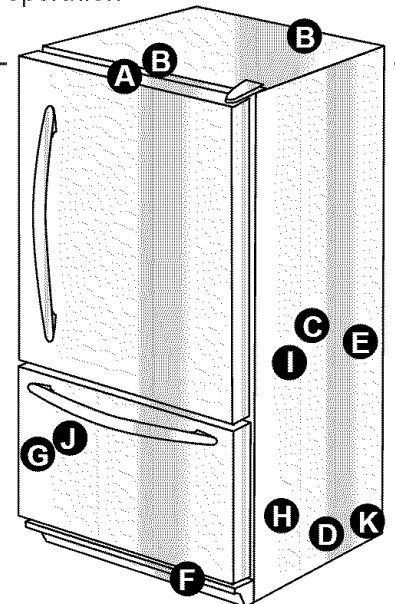

Troubleshooting

PROBLEM	POSSIBLE CAUSES	WHAT TO DO	
Freezer control and lights are on, but compressor is not operating	Refrigerator is in defrost mode.	Normal operation. Wait 40 minutes to see if refrigerator restarts.	
Crisper drawer temperature is too warm	Control settings are too low.	See pages 10 or 11 to adjust controls.	
Refrigerator does not operate	Refrigerator is not plugged in.	Plug in refrigerator.	
	Control is not on.	See pages 10 or 11 to adjust your controls.	
	Fuse is blown, or circuit breaker needs to be reset.	Replace any blown fuses. Check circuit breaker and reset, if necessary.	
	Power outage has occurred.	Call local power company listing to report outage.	
Refrigerator still won't operate	Refrigerator is malfunctioning.	Unplug refrigerator and transfer food to another refrigerator. If another refrigerator is not available, place dry ice in freezer section to preserve food. Warranty does not cover food loss. Contact service for assistance.	
Food temperature is too cold	Condenser coils are dirty.	Clean according to the chart on page 21.	
	Refrigerator or freezer controls are set too high.	See pages 10 or 11 to adjust your controls.	
Food temperature is too warm	Door is not closing properly.	Refrigerator is not level. See page 3 for details on how to level your refrigerator. Check gaskets for proper seal. Clean, if necessary, according to the chart on page 21. Check for internal obstructions that are keeping door from closing properly (i.e. improperly closed drawers, ice buckets, oversized or improperly stored containers, etc.)	
	Controls need to be adjusted.	See pages 10 or 11 to adjust your controls.	
	Condenser coils are dirty.	Clean according to the chart on page 21.	
	Rear air grille is blocked.	Check the positioning of food items in refrigerator to make sure grille is not blocked. Rear air grilles are located under crisper drawers.	
	Door has been opened frequently, or has been opened for long periods of time.	Reduce time door is open. Organize food items efficiently to assure door is open for as short a time as possible.	
	Food has recently been added.	Allow time for recently added food to reach refrigerator or freezer temperature.	
	Refrigerator has an odor	Compartment is dirty or has odor-causing food.	Clean according to instructions on page 22.
	Water droplets form on outside of refrigerator	Check gaskets for proper seal.	Clean according to the chart on page 21.
Humidity levels are high.		Normal during times of high humidity.	
Controls require adjustment.		See pages 10 or 11 to adjust your controls.	



Troubleshooting

PROBLEM	POSSIBLE CAUSES	WHAT TO DO	
Water droplets form on inside of refrigerator	Humidity levels are high or door has been opened frequently.	See pages 10 or 11 to adjust your controls. Reduce time door is open. Organize food items efficiently to assure door is open for as short a time as possible.	
	Check gaskets for proper seal.	Clean, if necessary, according to the chart on page 21.	
Refrigerator or ice maker makes unfamiliar sounds or seems too loud	Normal operation.	See page 25.	
Crisper drawers do not close freely	Contents of drawer, or positioning of items in the surrounding compartment could be obstructing drawer.	Reposition food items and containers to avoid interference with the drawers.	
	Drawer is not in proper position.	See page 13 for proper drawer placement.	
	Refrigerator is not level.	See page 3 for details on how to level your refrigerator.	
	Drawer channels are dirty or need treatment.	Clean drawer channels with warm, soapy water. Rinse and dry thoroughly. Apply a thin layer of petroleum jelly to drawer channels.	
Refrigerator runs too frequently	Doors have been opened frequently or for long periods of time.	Reduce time door is open. Organize food items efficiently to assure door is open for as short a time as possible. Allow interior environment to adjust for period the door has been opened.	
	Humidity or heat in surrounding area is high.	Normal operation.	
	Food has recently been added.	Allow time for recently added food to reach refrigerator or freezer temperature.	
	Refrigerator is exposed to heat by environment or by appliances nearby.	Evaluate your refrigerator's environment. Refrigerator may need to be moved to run more efficiently.	
	Condenser coils are dirty.	Clean, if necessary, according to the chart on page 21.	
	Controls need to be adjusted.	See pages 10 or 11 to adjust your controls.	
	Door is not closing properly.	Refrigerator is not level. See page 3 for details on how to level your refrigerator.	
		Check gaskets for proper seal. Clean, if necessary, according to the chart on page 21.	
		Check for internal obstructions that are keeping door from closing properly (i.e. improperly closed drawers, ice buckets, oversized or improperly stored containers, etc.)	
Normal Operation		See <i>Operating Sounds</i> on page 25.	

Troubleshooting

Ice

PROBLEM	POSSIBLE CAUSES	WHAT TO DO
Refrigerator is leaking water	Plastic tubing was used to complete water connection.	The manufacturer recommends using copper tubing for installation. Plastic is less durable and can cause leakage. The manufacturer is not responsible for property damage due to improper installation or water connection.
	Improper water valve was installed.	Check water connection (see page 9). Self-piercing and $\frac{3}{16}$ " saddle valves cause low water pressure and may clog the line over time. The manufacturer is not responsible for property damage due to improper installation or water connection.
Ice forms in inlet tube to ice maker	Water pressure is low.	Water pressure must be between 35 to 100 pounds per square inch to function properly.
	Freezer temperature is too high.	Adjust freezer control (see page 10 or 11). Freezer is recommended to be approximately 0° F (-18° C).



Warranty & Service

Warranty

Full One Year Warranty

One (1) year - From the date of original retail purchase, any part that fails in normal home use will be repaired or replaced free of charge.

Ice Maker - When purchased with the refrigerator and installed by the dealer the ice maker will be considered part of the refrigerator for warranty purposes.

Limited Warranty - Major Refrigeration Components

Second Through Fifth Year - After the first year from the date of original purchase, through the fifth year, Maytag ServicesSM will repair or replace, at its option, free of charge for parts and labor only, any part of the sealed refrigeration system (consisting of the compressor, evaporator, condenser, drier and connecting tubing) and the cabinet liner (exclusive of the door liner) which fail in normal home use. All other costs, including mileage, transportation, trip charge and diagnostic charge, if required, shall be the responsibility of the owner.

Limited Warranty - Other Parts

Second Year - Parts other than major refrigeration components which fail in normal home use during the second year following the date of original retail purchase will be repaired or provided free of charge for the part itself, with the owner paying all other costs, including labor, mileage, transportation, trip charge and diagnostic charge, if required.

Note

The full warranty and the limited warranties apply when the refrigerator is located in the United States or Canada. Refrigerators located elsewhere are covered by the limited warranties only including parts that fail during the first year.

Canadian Residents

The above warranties only cover an appliance installed in Canada that has been certified or listed by appropriate test agencies for compliance to a National Standard of Canada unless the appliance was brought into Canada due to transfer of residence from the United States to Canada.

Limitations of Liability

The warrantor shall not be liable for any incidental or consequential damages, including food loss. Some states do not allow the exclusion or limitation of consequential damages, so the above limitation or exclusion may not apply to you.

*The specific warranties expressed above are the **ONLY** warranties provided by the manufacturer. These warranties give you specific legal rights, and you may also have other rights which vary from state to state.*

What is Not Covered By These Warranties:

1. Conditions and damages resulting from any of the following:
 - a. Improper installation, delivery, or maintenance.
 - b. Any repair, modification, alteration, or adjustment not authorized by the manufacturer or an authorized servicer.
 - c. Misuse, abuse, accidents, or unreasonable use.
 - d. Incorrect electric current, voltage, or supply.
 - e. Improper setting of any control.
2. Warranties are void if the original serial numbers have been removed, altered or cannot be readily determined.
3. Light bulbs.
4. Products purchased for commercial or industrial use.
5. The cost of service or service call to:
 - a. Correct installation errors.
 - b. Instruct the user on the proper use of the product.
 - c. Transport the appliance to the servicer.
6. Consequential or incidental damages sustained by any person as a result of any breach of these warranties. Some states do not allow the exclusion or limitation of consequential or incidental damages, so the above exclusion may not apply.

If You Need Service

- Call the dealer from whom your appliance was purchased or call Maytag ServicesSM, Maytag Customer Assistance at 1-800-688-9900 U.S.A. or 1-800-688-2002 Canada, to locate an authorized servicer.
- Be sure to retain proof of purchase to verify warranty status. Refer to *Warranty* for further information on owner's responsibilities for warranty service.
- If the dealer or service company cannot resolve the problem, write to Maytag ServicesSM, Attn: CAIR® Center, P.O. Box 2370, Cleveland, TN 37320-2370 or call **1-800-688-9900 U.S.A. or 1-800-688-2002 Canada**. U.S. customers using TTY for deaf, hearing impaired or speech impaired, call 1-800-688-2080.
- User's guides, service manuals and parts information are available from Maytag ServicesSM, Maytag Customer Assistance.

Note

- When writing or calling about a service problem, please include the following information:
 - a. Your name, address and telephone number;
 - b. Model number and serial number;
 - c. Name and address of your dealer or servicer;
 - d. A clear description of the problem you are having;
 - e. Proof of purchase (sales receipt).