

Panasonic®

Operating Instructions

High Definition Video Camera

Model No. **HDC-SD9P/PC**

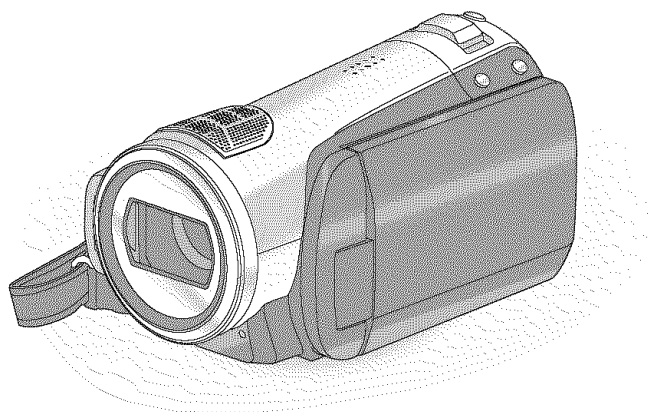

Before connecting, operating or adjusting this product, please read the instructions completely.
Spanish Quick Use Guide is included.

Guía para rápida consulta en español está incluida.

AVCHD™



HDMI™
HIGH-DEFINITION MULTIMEDIA INTERFACE



SD
HC
CLASS 4

VIERA Link™

LEICA
DICOMAR

For USA assistance, please call: 1-800-211-PANA(7262) or, contact us via the web at: <http://www.panasonic.com/contactinfo>

For Canadian assistance, please call: 1-800-561-5505 or visit us at www.panasonic.ca

VQT1N45

Things You Should Know

Thank you for choosing Panasonic!

You have purchased one of the most sophisticated and reliable products on the market today. Used properly, we're sure it will bring you and your family years of enjoyment. Please take time to fill in the information on the right.

The serial number is on the tag located on the underside of your camera. Be sure to **retain this manual** as your convenient camera information source.

Date of Purchase

Dealer Purchased From

Dealer Address

Dealer Phone No.

Model No.

Serial No.

Safety Precautions

WARNING:

TO REDUCE THE RISK OF FIRE, ELECTRIC SHOCK OR PRODUCT DAMAGE,

- DO NOT EXPOSE THIS APPARATUS TO RAIN, MOISTURE, DRIPPING OR SPLASHING AND THAT NO OBJECTS FILLED WITH LIQUIDS, SUCH AS VASES, SHALL BE PLACED ON THE APPARATUS.
- USE ONLY THE RECOMMENDED ACCESSORIES.
- DO NOT REMOVE THE COVER (OR BACK); THERE ARE NO USER SERVICEABLE PARTS INSIDE. REFER SERVICING TO QUALIFIED SERVICE PERSONNEL.

CAUTION!

DO NOT INSTALL OR PLACE THIS UNIT IN A BOOKCASE, BUILT-IN CABINET OR IN ANOTHER CONFINED SPACE. ENSURE THE UNIT IS WELL VENTILATED. TO PREVENT RISK OF ELECTRIC SHOCK OR FIRE HAZARD DUE TO OVERHEATING, ENSURE THAT CURTAINS AND ANY OTHER MATERIALS DO NOT OBSTRUCT THE VENTILATION VENTS.

The socket outlet shall be installed near the equipment and easily accessible. The mains plug of the power supply cord shall remain readily operable. To completely disconnect this apparatus from the AC Mains, disconnect the power supply cord plug from AC receptacle.

The following mark and symbols are located on bottom of the unit.



CAUTION
RISK OF ELECTRIC SHOCK
DO NOT OPEN





The lightning flash with arrowhead symbol, within an equilateral triangle, is intended to alert the user to the presence of uninsulated "dangerous voltage" within the product's enclosure that may be of sufficient magnitude to constitute a risk of electric shock to persons.

CAUTION: TO REDUCE THE RISK OF ELECTRIC SHOCK, DO NOT REMOVE SCREWS. NO USER-SERVICEABLE PARTS INSIDE. REFER SERVICING TO QUALIFIED SERVICE PERSONNEL.



The exclamation point within an equilateral triangle is intended to alert the user to the presence of important operating and maintenance (servicing) instructions in the literature accompanying the appliance.

THE FOLLOWING APPLIES ONLY IN THE U.S.A.

FCC Note:

This equipment has been tested and found to comply with the limits for a Class B digital device, pursuant to Part 15 of the FCC Rules. These limits are designed to provide reasonable protection against harmful interference in a residential installation. This equipment generates, uses, and can radiate radio frequency energy and, if not installed and used in accordance with the instructions, may cause harmful interference to radio communications. However, there is no guarantee that interference will not occur in a particular installation. If this equipment does cause harmful interference to radio or television reception, which can be determined by turning the equipment off and on, the user is encouraged to try to correct the interference by one or more of the following measures:

- Reorient or relocate the receiving antenna.
- Increase the separation between the equipment and receiver.
- Connect the equipment into an outlet on a circuit different from that to which the receiver is connected.
- Consult the dealer or an experienced radio/TV technician for help.

FCC Caution: To assure continued compliance, follow the attached installation instructions and use only shielded interface cables with ferrite core when connecting to computer or peripheral devices.
Any changes or modifications not expressly approved by the party responsible for compliance could void the user's authority to operate this equipment.

Declaration of Conformity

Trade Name: Panasonic
Model No.: HDC-SD9P
Responsible party: Panasonic Corporation of North America
One Panasonic Way, Secaucus, NJ 07094
Support Contact: Panasonic Consumer Electronics Company
1-800-211-PANA (7262)

This device complies with Part 15 of the FCC Rules. Operation is subject to the following two conditions: (1) This device may not cause harmful interference, and (2) this device must accept any interference received, including interference that may cause undesired operation.



THE FOLLOWING APPLIES ONLY IN CANADA.

This Class B digital apparatus complies with Canadian ICES-003.

Batteries

1 Battery pack (Lithium ion battery pack)

- Use the specified unit to recharge the battery pack.
- Do not use the battery pack with equipment other than the specified unit.
- Do not get dirt, sand, liquids, or other foreign matter on the terminals.
- Do not touch the plug terminals (+ and -) with metal objects.
- Do not disassemble, remodel, heat or throw into fire.

2 Button-type battery (Lithium battery)

- Insert with poles aligned.
- Do not touch the terminals (+ and -) with metal objects.
- Do not recharge, disassemble, remodel, heat or throw into fire.
- Keep out of reach of children

If any electrolyte should come into contact with your hands or clothes, wash it off thoroughly with water.

If any electrolyte should come into contact with your eyes, never rub the eyes. Rinse eyes thoroughly with water, and then consult a doctor.

Warning

Risk of fire, explosion and burns. Do not disassemble.

Do not heat the batteries above the following temperatures or incinerate.

Button-type battery 60 °C (140 °F)

Battery pack 60 °C (140 °F)

AC adaptor

This AC adaptor operates on AC between 110 V and 240 V.

But

- In the U.S.A. and Canada, the AC adaptor must be connected to a 120V AC power supply only.
- When connecting to an AC supply outside of the U.S.A. or Canada, use a plug adaptor to suit the AC outlet configuration.
- When connecting to a supply of greater than AC 125V, ensure the cord you use is suited to the voltage of the AC supply and the rated current of the AC adaptor.
- Contact an electrical parts distributor for assistance in selecting a suitable AC plug adaptor or AC cord set.

Product Identification Marking is located on the bottom of units.

U.S.A./CANADA CONSUMERS: ATTENTION:



A lithium ion/polymer battery that is recyclable powers the product you have purchased. Please call 1-800-8-BATTERY for information on how to recycle this battery.

<For USA-California only>

This product contains a CR Coin Cell Lithium Battery which contains Perchlorate Material – special handling may apply.

See www.dtsc.ca.gov/hazardouswaste/perchlorate.

IMPORTANT SAFETY INSTRUCTIONS

Read these operating instructions carefully before using the unit. Follow the safety instructions on the unit and the applicable safety instructions listed below. Keep these operating instructions handy for future reference.

- 1) Read these instructions.
- 2) Keep these instructions.
- 3) Heed all warnings.
- 4) Follow all instructions.
- 5) Do not use this apparatus near water.
- 6) Clean only with dry cloth.
- 7) Do not block any ventilation openings. Install in accordance with the manufacturer's instructions.
- 8) Do not install near any heat sources such as radiators, heat registers, stoves, or other apparatus (including amplifiers) that produce heat.
- 9) Do not defeat the safety purpose of the polarized or grounding-type plug. A polarized plug has two blades with one wider than the other. A grounding-type plug has two blades and a third grounding prong. The wide blade or the third prong are provided for your safety. If the provided plug does not fit into your outlet, consult an electrician for replacement of the obsolete outlet.
- 10) Protect the power cord from being walked on or pinched particularly at plugs, convenience receptacles, and the point where they exit from the apparatus.
- 11) Only use attachments/accessories specified by the manufacturer.

- 12) Use only with the cart, stand, tripod, bracket, or table specified by the manufacturer, or sold with the apparatus. When a cart is used, use caution when moving the cart/apparatus combination to avoid injury from tip-over.



- 13) Unplug this apparatus during lightning storms or when unused for long periods of time.
- 14) Refer all servicing to qualified service personnel. Servicing is required when the apparatus has been damaged in any way, such as power-supply cord or plug is damaged, liquid has been spilled or objects have fallen into the apparatus, the apparatus has been exposed to rain or moisture, does not operate normally, or has been dropped.

Precautions

USE & LOCATION

WARNING

- **TO AVOID SHOCK HAZARD ...** Your camera and power supply should not be exposed to rain or moisture. Do not connect the power supply or operate your camera if it gets wet. Your camera has been designed for outdoor use, however it is not designed to sustain direct exposure to water, rain, sleet, snow, sand, dust, or a direct splashing from a pool or even a cup of coffee. This action could permanently damage the internal parts of your camera. Do not attempt to disassemble this unit. There are no user serviceable parts inside. Unplug your camera from the power supply before cleaning.
- **AS WITH ANY SMALL OBJECT, SD CARDS CAN BE SWALLOWED BY YOUNG CHILDREN. DO NOT ALLOW CHILDREN TO HANDLE THE SD CARD.**

CAUTION

- **DO NOT AIM YOUR CAMERA AT THE SUN OR OTHER BRIGHT OBJECTS**
- **DO NOT LEAVE THE CAMERA WITH THE EVF AIMED DIRECTLY AT THE SUN AS THIS MAY CAUSE DAMAGE TO THE INTERNAL PARTS OF THE EVF**
- **DO NOT EXPOSE YOUR CAMERA TO EXTENDED HIGH TEMPERATURE ...** Such as, in direct sunlight, inside a closed car, next to a heater, etc... This action could permanently damage the internal parts of your camera.
- **AVOID SUDDEN CHANGES IN TEMPERATURE ...** If the unit is suddenly moved from a cold place to a warm place, moisture may form on the SD card and inside the unit.
- **DO NOT LEAVE YOUR CAMERA OR THE POWER SUPPLY TURNED ON WHEN NOT IN USE.**
- **STORAGE OF YOUR CAMERA ...** Store and handle your camera in a manner that will not subject it to unnecessary movement (avoid shaking and striking). Your camera contains a sensitive pick-up device which could be damaged by improper handling or storage.

CARE

- **TO CLEAN YOUR CAMERA ...** Do not use strong or abrasive detergents when cleaning your camera body.
- **TO PROTECT THE LENS ...** Do not touch the surface of the lens with your hand. Use a commercial camera lens solution and lens paper when cleaning the lens. Improper cleaning can scratch the lens coating.
- **TO PROTECT THE FINISH OF YOUR CAMERA ...** Before handling your camera, make sure your hands and face are free from any chemical products, such as suntan lotion, as it may damage the finish.

-If you see this symbol-

Information on Disposal in other Countries outside the European Union

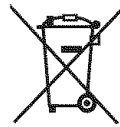

This symbol is only valid in the European Union. If you wish to discard this product, please contact your local authorities or dealer and ask for the correct method of disposal.

■ Indemnity concerning recording content

The manufacturer shall in no event be liable for the loss of recordings due to malfunction or defect of this unit, its accessories or recordable media.

IMPORTANT

■ Carefully observe copyright laws

Whatever you have recorded and created can be used for your personal entertainment only. Under copyright laws, other materials cannot be used without obtaining permission from the holders of the copyrights.

■ Cards that you can use with this unit

SD Memory Card and SDHC Memory Card

- 4 GB (or more) Memory Cards that do not have the SDHC logo are not based on SD Memory Card Specifications.
- Refer to page 24 for more details on SD cards.

■ For the purposes of these operating instructions

- SD Memory Card and SDHC Memory Card are referred to as the "SD card".
- Functions that can be used for motion picture recording/motion picture playback are indicated by **VIDEO** in these operating instructions.
- Functions that can be used for still picture recording/still picture playback are indicated by **PHOTO** in these operating instructions.
- "HD Writer 2.5E for HDC" is referred to as the "HD Writer 2.5E".
- Pages for reference are indicated by an arrow, for example: → 00

■ Licenses

- SDHC Logo is a trademark.
- "AVCHD" and the "AVCHD" logo are trademarks of Matsushita Electric Industrial Co., Ltd. and Sony Corporation.
- Manufactured under license from Dolby Laboratories.
Dolby and the double-D symbol are trademarks of Dolby Laboratories.
- HDMI, the HDMI Logo and the High-Definition Multimedia Interface are the registered trademarks or trademarks of HDMI Licensing LLC.
- VIERA Link™ is a trademark of Matsushita Electric Industrial Co., Ltd.
- EZ Sync™ is a trademark of Matsushita Electric Industrial Co., Ltd.

- HDAVI Control™ is a trademark of Matsushita Electric Industrial Co., Ltd.
- "x.v.Color" is trademark.
- LEICA is a registered trademark of Leica Microsystems IR GmbH and DICOMAR is a registered trademark of Leica Camera AG.
- Microsoft®, Windows®, Windows Vista® and DirectX® are either registered trademarks or trademarks of the Microsoft Corporation in the United States and/or other countries.
- Microsoft product screen shot(s) reprinted with permission from Microsoft Corporation.
- IBM and PC/AT are registered trademarks of International Business Machines Corporation of the U.S.
- Intel®, Core™, Pentium® and Celeron® are the registered trademarks or trademarks of the Intel Corporation in the United States and other countries.
- AMD Athlon is a trademark of the Advanced Micro Devices, Inc.
- Apple, Mac OS is either registered trademarks or trademarks of Apple Inc. in the United States and/or other countries.
- PowerPC is a trademark of International Business Machines Corporation.
- Other names of systems and products mentioned in these instructions are usually the registered trademarks or trademarks of the manufacturers who developed the system or product concerned.

This product is licensed under the AVC patent portfolio license for the personal and non-commercial use of a consumer to (i) encode video in compliance with the AVC Standard ("AVC Video") and/or (ii) decode AVC Video that was encoded by a consumer engaged in a personal and non-commercial activity and/or was obtained from a video provider licensed to provide AVC Video. No license is granted or shall be implied for any other use. Additional information may be obtained from MPEG LA, LLC. See <http://www.mpegla.com>.

Contents

Accessories	10
Features	11
Quick Guide	12

Preparation

Before using

1 Parts identification and handling	16
Remote control	19

Setup

1 Power supply	20
Charging the battery	20
Inserting/removing the battery	21
Charging and recording time	22
Connecting to the AC outlet.....	23
2 Preparation of SD cards	24
Cards that you can use with this unit.....	24
Inserting/removing an SD card	25
3 Selecting a mode (Turning the unit on/off)	26
Turning the power on and off with the LCD monitor	26
4 Using the menu screen	27
Language selection	28
Menu list	28
5 Setting date and time	30
World time setting (Displaying the time of the travel destination)	31
6 Adjusting LCD monitor	32
Increasing the brightness of the LCD monitor	32
Adjusting the brightness and the color level of the LCD monitor ...	32
Recording Yourself	32

Recording

Recording (Basic)

1 Before recording	34
Auto Ground-Directional Standby (AGS)	35
2 Recording motion pictures	36
Recording modes/ approximate recordable time.....	38
Quick start	39
PRE-REC	40
Shooting guide	40
3 Recording still pictures	41
Picture quality.....	43
Number of recordable pictures.....	43
4 Zoom in/out function	44
Digital zoom function.....	44
5 Image stabilizer function	45
6 Face detection & AE mode	46

Recording (Advanced)

1 Recording functions of operation icons	47
Operation icons	47
Fade, Intelligent contrast control, Help mode, Soft skin mode, MagicPix, Backlight compensation, Low light, Self-timer, Tele macro	
2 Recording functions of menus	51
Menus	51
Guide line, 24p digital cinema, Wind noise reduction, Microphone setup, Microphone level, HD hi-speed burst shooting, Built-in flash, Red eye reduction, Shutter sound, Zebra, Color bar, Auto slow shutter, Digital cinema color	
3 Manual recording functions	59
Scene mode.....	59
Manual focus adjustment	60
White balance	61
Manual shutter speed/ aperture adjustment	62

Playback

Playback

- 1 Motion picture playback** 64
Playing back motion pictures
by date..... 67
Intelligent scene selection 67
Repeat playback..... 68
Resuming the previous playback..... 68
- 2 Still picture playback**..... 69
Playing back still pictures by date... 71

Editing

- 1 Deleting scenes/still pictures** 72
- 2 Dividing a scene to delete** 74
- 3 Protecting scenes/still pictures** ... 75
- 4 DPOF setting**..... 76
- 5 Formatting**..... 77

With a TV

- 1 Watching Video/
Pictures on your TV**..... 78
Connecting with
a HDMI mini cable 81
Listening in 5.1 channel sound 82
Connecting with
the component cable 82
- 2 Playback using VIERA Link™
(HDAVI Control™)**..... 83

Backup

With other products

- 1 Connecting a DVD burner
to copy to/play back a disc**..... 86
Preparing for copying/
playing back..... 86
Copying to discs 87
Playing back the copied disc 90
Managing the copied disc
(Formatting/Auto protect/
Displaying disc information)..... 91
- 2 Dubbing images onto other video
device** 92
- 3 With a printer (PictBridge)**..... 93

With a PC

Before using

- 1 What you can do with a PC** 96
End User License Agreement 98
- 2 Operating environment**..... 99

Setup

- 1 Installation** 101
- 2 Connection and recognition** 103
About the PC display..... 104

Using with a PC

- 1 Starting HD Writer 2.5E**..... 105
Reading the operating instructions
of the software applications..... 105
- 2 If using Macintosh**..... 106

Others

Indications

- 1 Indications** 108
- 2 Messages**..... 111
About recovery 112

Helpful hints

- 1 Functions that cannot be used
simultaneously** 113
- 2 Troubleshooting** 115
Cautions for use..... 124
Explanation of terms 127
Specifications..... 129
Optional accessories..... 132
Accessory Order Form
(For USA Customers)..... 133
**Request for Service Notice
(USA Only)** 134
**Limited Warranty
(For USA Customers)** 135
Customer Services Directory..... 136
**Warranty
(For Canadian Customers)**..... 137
Index..... 138
**Spanish Quick Use Guide/
Guía española para el
uso rápido**..... 140

Accessories

Check the accessories before using this unit.

Battery pack

VW-VBG130



AC adaptor

VSK0697



AC cable

K2CA2CA00025



DC cable

K2GJYYC00001



Remote control

N2QAEC000023

Button-type battery

CR2025

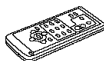

AV cable

K2KC4CB00027



Component cable

K2KZ9DB00004



USB cable

K2KZ4CB00011



CD-ROM



Features

■ Very clear high definition pictures

This unit can record detailed high definition images to an SD card.

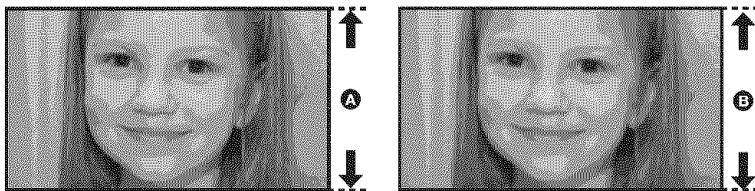

A High definition images (1920×1080)*

Number of available scan lines 1080

B Standard images (720×480)

Number of available scan lines 480

High definition images

- High definition images have more than approximately 2 times the number of available scan lines and approximately 6 times* the number of pixels compared with standard images.
- The still pictures above are images for explanation purposes.

* If the recording mode is HA/HG/HX.

What is the AVCHD?

This is a format for recording and playing back highly detailed high definition images.

Images are recorded based on the MPEG-4 AVC/H.264 codec for compressing images and audio is recorded with the Dolby Digital 5.1 Creator.

- Since the recording method is different from an ordinary DVD video etc., the data is not compatible.

■ Compatibility with other products

With other products	Available function	Picture quality
Watching Video/ Pictures on your TV (→ 78 to 84)	Playback with the HDMI mini cable (→ 81) – Playback using VIERA Link™ (HDAVI Control™) (→ 83)	High definition images
	Playback with the component cable [1080i] (→ 82)	
	Playback with the component cable [480i] (→ 82)	Standard images
	Playback with the AV cable (→ 78)	
Using a DVD burner (→ 86 to 91)	Connecting a DVD burner to copy to/play back a disc (→ 86) – Playing back the copied disc (→ 90)	High definition images
What you can do with a PC (→ 96 to 97)	Copying data to a PC and easy editing (→ 96)	High definition images
	Writing data to DVD discs and SD cards (→ 96)	
	Converting the motion picture data to MPEG2 (→ 96)	Standard images
	Creating a DVD Video disc (→ 96)	
Dubbing images onto other video device (→ 92)	Dubbing images when connecting with the AV cable (→ 92)	

Quick Guide

■ Charging the battery

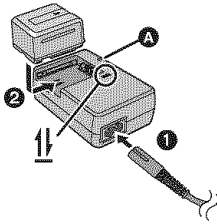

Charging lamp
[CHARGE] **A**

Lights up:
Charging
Goes off:
Charging
completed

- 1 Connect the AC cable to the AC adaptor and the AC outlet.
- 2 Insert the battery into the battery charger by aligning the arrows.

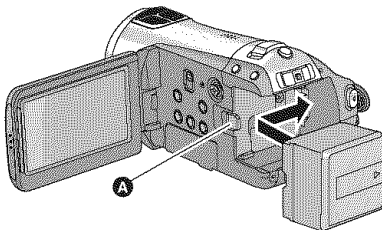

■ Inserting the battery

Open the LCD monitor and install the battery by inserting it in the direction shown in the figure.



- A** Insert the battery until it clicks and locks.

■ How to turn on the power

Turn on the power by sliding the mode switch to  or  while pressing the lock release button **A**.

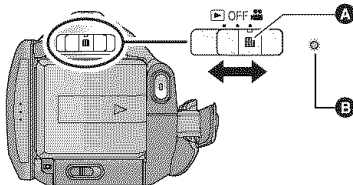

- Operate the mode switch while at the same time pressing in the lock release button if changing from OFF to another mode.
- Status indicator **B**
- To turn off the power, set the mode switch to OFF.

■ Inserting/removing an SD card

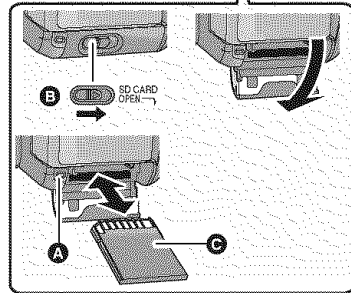
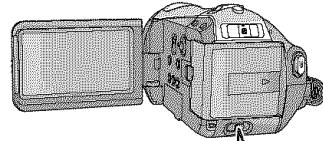

Card access lamp [ACCESS]

- When this unit is processing data, the access lamp **A** lights up.

- 1 Set the mode switch to OFF.
- 2 Open the SD card cover while sliding the SD CARD OPEN lever **B**.
- 3 Insert/remove the SD card.
 - When inserting an SD card, face the terminal side **C** in the direction shown in the illustration and press it straight in as far as it will go.
 - When removing the SD card, press the center of the SD card and then pull it straight out.
- 4 Securely close the SD card cover.
 - Securely close it until it clicks.

■ Language selection

- 1) Press the MENU button, then select [LANGUAGE] and press the cursor button.
- 2) Select [English] and press the cursor button.

■ Help mode

The help mode explains the operation icons displayed when the AUTO/MANUAL/FOCUS switch is set to AUTO in recording mode.

- Operate the mode switch to select .
- 1) Press the cursor button to display the icon.



- 2) Move the cursor button right to select [].



- 3) Move the cursor button up, left or right to select the desired icon.

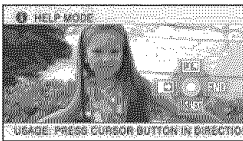

- An explanation of the selected icon scrolls at the bottom of the screen.
- The indication changes each time the cursor button is moved down.
- When the help mode is used, functions cannot be set.

To exit the Help mode



Press the MENU button or select [END].

■ Recording motion pictures

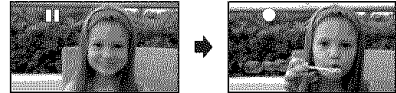
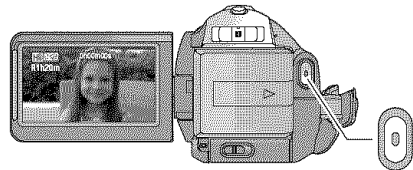
- 1) Operate the mode switch to select  and open the LCD monitor.
- 2) Press the recording start/stop button to start recording.



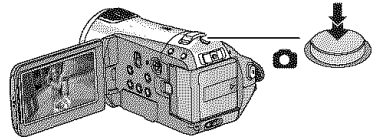

■ Recording still pictures

- 1) Operate the mode switch to select  and open the LCD monitor.
- 2) Press the  button fully to take the picture.



■ Motion picture playback

- 1) Operate the mode switch to select .
- 2) Select [] (motion picture playback)  with the cursor button.

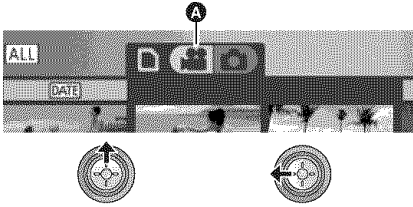



- 3) Select the scene to be played back and press the cursor button.

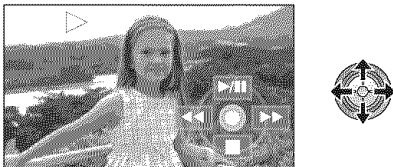

- 4) Select the playback operation with the cursor button.



■ Still picture playback

- 1) Operate the mode switch to select .
- 2) Select [] (still picture playback)  with the cursor button.

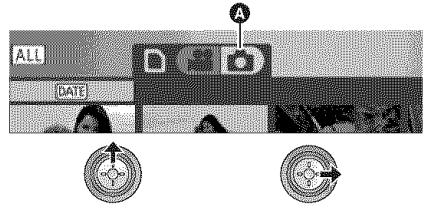







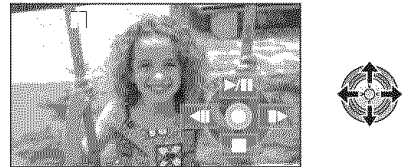

- 3) Select the still picture to be played back and press the cursor button.



- 4) Select the playback operation with the cursor button.



- : Playback/Pause
- : Rewind playback
- : Fast forward playback
- : Stops the playback and shows the thumbnails.

- : Slide show (playback of the still pictures in numerical order) start/pause.
- : Plays back the previous picture.
- : Plays back the next picture.
- : Stops the playback and shows the thumbnails.

Preparation

Recording

Playback

Backup

With a PC

Others

16 Before using

20 Setup

Parts identification and handling

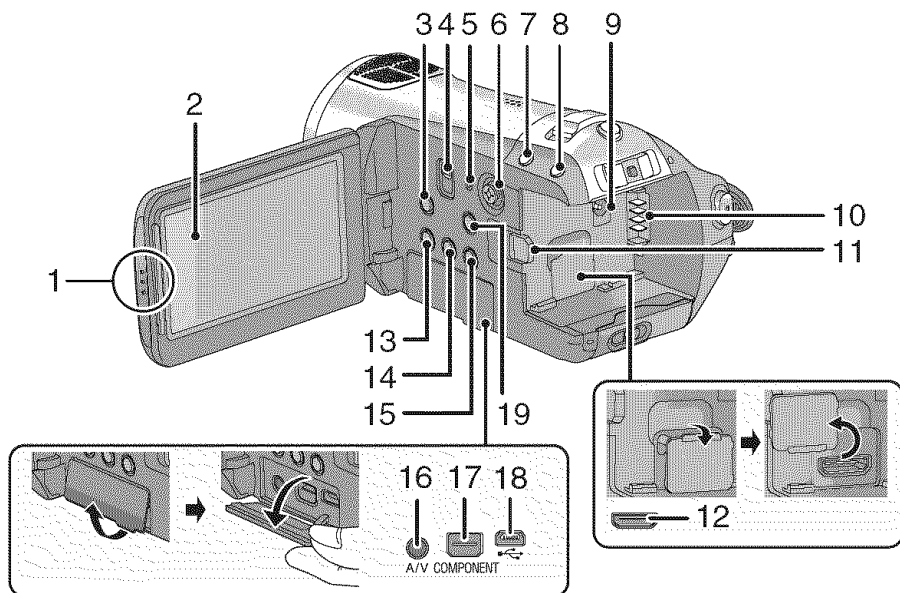

1 LCD monitor open part

2 LCD monitor (→ 32)

Pull the LCD monitor out in the direction of the arrow with your fingers.

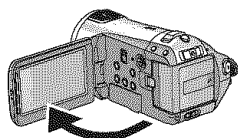

- It can open up to 90°.

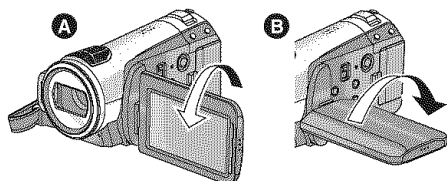

- It can rotate up to 180° **A** towards the lens or 90° **B** towards the opposite direction.



Due to limitations in LCD production technology, there may be some tiny bright or dark spots on the LCD monitor screen. However, this is not a malfunction and does not affect the recorded picture.

- 3 Optical image stabilizer button [(👁️)], O.I.S.] (→ 45)
- 4 Mode select switch [AUTO/MANUAL/ FOCUS] (→ 35, 59)
- 5 Reset button [RESET] (→ 118)
- 6 Cursor button

Use the cursor button to select the recording functions and playback operations, and to operate the menu screen.



- 1 Select by moving up, down, left, right.
- 2 Set by pressing the center.
- Menu screen operations (→ 27)
- To select the recording functions (→ 47, 51)

- To adjust manually (→ 59)
- Playback operations (→ 64, 69)
- 7 Face detection button [] (→ 46)
- 8 PRE-REC button [PRE-REC] (→ 40)
- 9 DC input terminal [DC IN 9.3V] (→ 23)
- 10 Battery holder (→ 21)
- 11 Battery release lever [BATTERY] (→ 21)
- 12 HDMI mini connector [HDMI] (→ 81, 83)
- 13 Disc copy button [DISC COPY] (→ 89)
- 14 Power LCD Extra button [POWER LCD EXTRA] (→ 32)
- 15 Delete button [] (→ 72)
- 16 Audio-video output terminal [AV] (→ 78, 92)
- Use the supplied AV cable only.
- 17 Component terminal [COMPONENT] (→ 82)
- 18 USB terminal [] (→ 86, 93, 103)
- 19 Menu button [MENU] (→ 27)

- When fitting the tele conversion lens (VW-T3714H; optional) or the wide conversion lens (VW-W3707H; optional), first remove the lens hood.

Be careful about the following.

When 2 lens accessories, such as the ND filter and tele conversion lens, are fitted and the zoom lever is pressed toward the W side, the 4 corners of an image will be darkened. (Vignetting)
(When fitting 2 lens accessories, first remove the lens hood and then fit them.)

- 23 Remote control sensor (→ 19)
- 24 Recording lamp (→ 28)

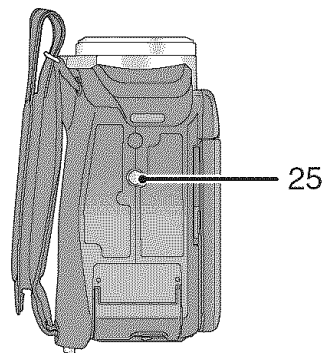
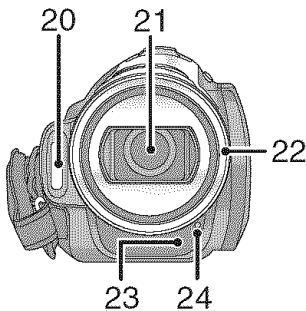

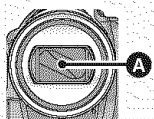

- 20 Built-in flash (→ 55)
- 21 Lens (LEICA DICOMAR)

Lens cover 



- The lens cover opens in recording mode. (→ 26)

22 Lens hood

Rotate the lens hood counter-clockwise  to remove it. In order to attach it, place into slot , and then rotate it clockwise .

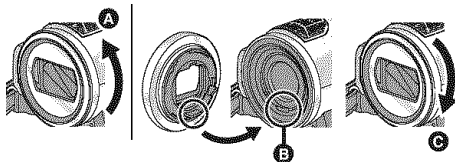

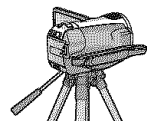
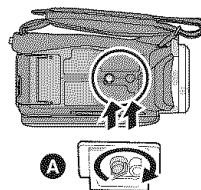

25 Tripod receptacle

This is a hole for attaching the unit to the optional tripod. (For details on mounting the tripod, refer to the operating instructions for the tripod.)

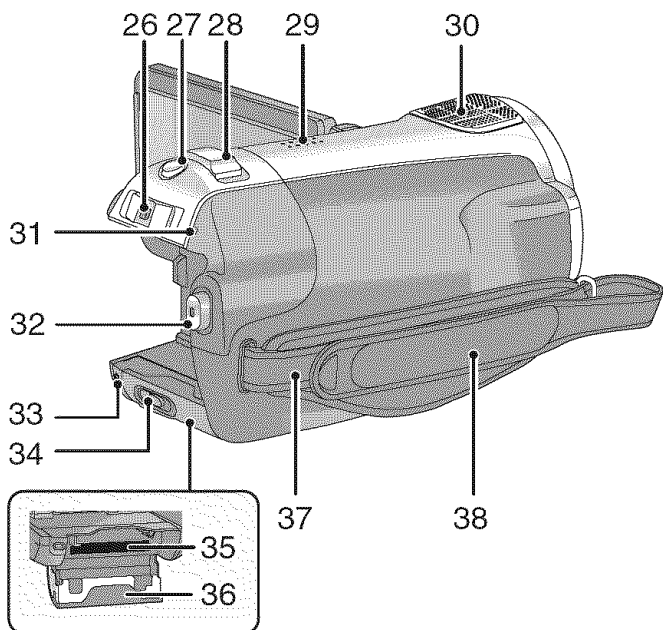

-  Camera base



- 26 Mode switch (→ 26)
- 27 Photoshot button [] (→ 41)
- 28 Zoom lever [W/T] (In recording mode) (→ 44)
Volume lever [-VOL+] (In playback mode) (→ 65)
- 29 Speaker
- 30 Internal microphones (5.1 channel support)
- 31 Status indicator (→ 26)
- 32 Recording start/stop button (→ 36)
- 33 Card access lamp [ACCESS] (→ 25)
- 34 SD card open lever [SD CARD OPEN] (→ 25)
- 35 Card slot (→ 25)
- 36 SD card cover (→ 25)
- 37 Shoulder strap fixture

38 Grip belt

Adjust the length of the grip belt so that it fits your hand.

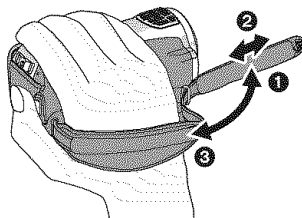

- ❶ Flip the belt.
- ❷ Adjust the length.
- ❸ Replace the belt.

Remote control

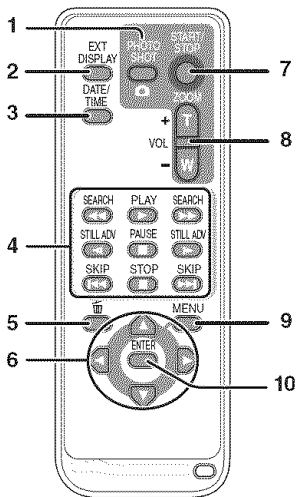

- 1 Photoshot button []*
- 2 On-screen display button [EXT DISPLAY] (→ 80)
- 3 Date/time button [DATE/TIME] (→ 30)
- 4 Playback operation buttons (→ 65)
- 5 Delete button []*
- 6 Direction buttons [, , ,]
- 7 Recording start/stop button [START/STOP]*
- 8 Zoom/volume buttons [ZOOM, VOL]*
- 9 Menu button [MENU]*
- 10 Enter button [ENTER]

These buttons operate similar to how the cursor button moves up/down/right/left on the unit.

* means that these buttons function in the same manner as the corresponding buttons on the unit.

CAUTION

Danger of explosion if battery is incorrectly replaced. Replace only with the same or equivalent type recommended by the manufacturer. Dispose of used batteries according to the manufacturer's instructions.

Install a button-type battery (supplied)

- 1 While pressing the stopper **A**, pull out the battery holder.
- 2 Set the button-type battery with its (+) mark facing upward and then put the battery holder back in place.

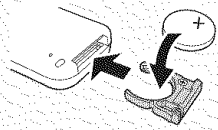
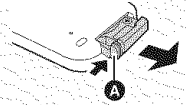

- When the button-type battery runs down, replace it with a new battery (part number: CR2025). The battery should normally last about 1 year, however this depends on how frequently the unit is used.
- Keep the button-type battery out of reach of children to prevent swallowing.

Replace battery with Panasonic PART NO. CR2025 only. Use of another battery may present a risk of fire or explosion. Caution: Battery may explode if mistreated. Dispose of used battery promptly. Keep away from children. Do not recharge, disassemble or dispose of in fire.

Remote control usable range

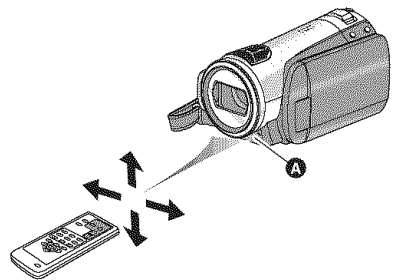

- A** Remote control sensor
 Distance: Within approx. 5 m (16 feet)
 Angle: Approx. 10° up and 15° down, left, and right

- The remote control is intended for indoor operation. Outdoors or under strong light, the unit may not operate properly even within the usable ranges.

Power supply

■ About batteries that you can use with this unit

The Panasonic battery that can be used with this unit is VW-VBG130/VW-VBG260/VW-VBG6. VW-VBG130/VW-VBG260/VW-VBG6 come with a function to check whether the battery and unit can be safely used together.

- To use the VW-VBG6 for this unit, the battery pack holder kit VW-VH04 (optional) is required.
- Batteries made by other companies which have been certified by Panasonic may be used with this unit, but we offer no guarantee as to the quality, performance or safety of such batteries.
- In order to safely use the unit, we recommend that you use genuine Panasonic batteries which have been tested by our quality control process.
- We cannot accept any liability whatsoever for damages to the unit or accidents caused by non-genuine Panasonic batteries (including those that have been certified by Panasonic).
- Exercise care when purchasing batteries. Many fake or imitation batteries have been found among those sold at unusually low prices and those which customers cannot check for themselves before purchasing.

Charging the battery

When this unit is purchased, the battery is not charged. Charge the battery before using this unit.

Important:

If the DC cable is connected to the AC adaptor, then the battery will not charge. Remove the DC cable from the AC adaptor.

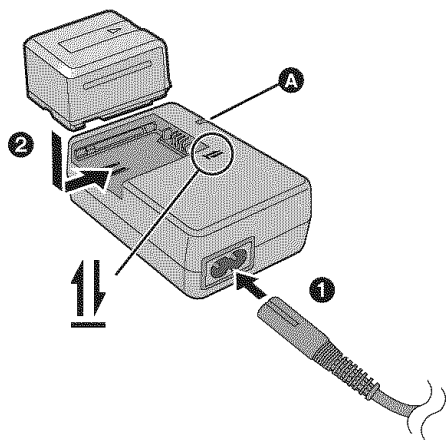

Charging lamp [CHARGE] **A**

Lights up:

Charging (Battery charging time: → 22)

Goes off:

Charging completed

Flashing:

Make sure that the terminals of the battery or the AC adaptor are not exposed to dirt, foreign objects or dust, then reconnect them properly.

(→ 125)

1 Connect the AC cable to the AC adaptor and the AC outlet.

2 Insert the battery into the battery charger by aligning the arrows.

- We recommend using Panasonic batteries (→ 10, 22, 132).
- If you use other batteries, we cannot guarantee the quality of this product.
- Do not heat or expose to flame.
- Do not leave the battery(ies) in an automobile exposed to direct sunlight for a long period of time with doors and windows closed.

Inserting/removing the battery

Open the LCD monitor and install the battery by inserting it in the direction shown in the figure.

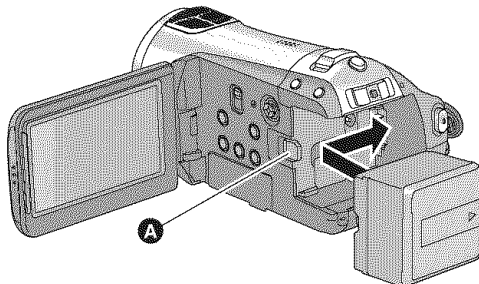

A Insert the battery until it clicks and locks.

Removing the battery

Be sure to set the mode switch to OFF and check that the status indicator is off before removing the battery.

Move the **BATTERY** lever in the direction indicated by the arrow and remove the battery when unlocked.

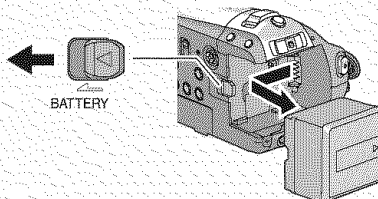

CAUTION

Danger of explosion if battery is incorrectly replaced. Replace only with the same or equivalent type recommended by the manufacturer. Dispose of used batteries according to the manufacturer's instructions.

Charging and recording time

- Temperature: 25 °C (77 °F)/humidity: 60%

■ Charging time

Battery model number	Voltage/capacity	Charging time
Supplied battery/ VW-VBG130 (optional)	7.2 V/1320 mAh	2 h 35 min
VW-VBG260 (optional)	7.2 V/2640 mAh	4 h 40 min
VW-VBG6 (optional)*	7.2 V/5800 mAh	9 h 25 min



■ Recording time

Battery model number	Voltage/ capacity	Maximum continuously recordable time	Actual recordable time
Supplied battery/ VW-VBG130 (optional)	7.2 V/1320 mAh	1 h 45 min	1 h 5 min
VW-VBG260 (optional)	7.2 V/2640 mAh	3 h 20 min	2 h
VW-VBG6 (optional)*	7.2 V/5800 mAh	8 h 10 min	5 h 5 min

* The battery pack holder kit VW-VH04 (optional) is necessary.

- These times are approximations.
- The indicated charging time is for when the battery has been discharged completely. The charging time may vary depending on how the battery has been used. The charging time for the battery in hot/cold environments or a battery that has not been used for long time may be longer than normal.
- The actual recordable time refers to the recordable time when repeatedly starting/stopping recording, turning the unit on/off, moving the zoom lever etc.
- The recordable times will vary depending on the status of use. Be aware that the operating time of the battery will become shorter in low temperatures. We recommend charging a spare battery for use when recording.
- The batteries heat up after use or charging. This is not a malfunction.
- It is not necessary to consume the battery completely. The battery can be recharged even if some capacity remains.

Battery capacity indication

- The display changes as the battery capacity reduces. . If there is less than 3 minutes remaining, then  will become red. If the battery discharges, then () will flash.
- The remaining battery capacity is displayed in minutes when using the Panasonic battery that you can use for this unit. It may take time to display the remaining battery capacity. The actual time can vary depending on your actual use.
- The maximum amount of remaining battery capacity able to be indicated is 999 minutes. If the actual remaining time exceeds 999 minutes, the indication will stay green and will not change until the remaining time falls below 999 minutes.
- When switching modes, the time indication will turn off momentarily in order to recalculate the remaining battery capacity time.
- When using the AC adaptor or batteries made by other companies, the remaining battery capacity will not be shown.

Connecting to the AC outlet

Important:

While the DC cable is connected to the AC adaptor, the battery will not charge.

- Do not use the AC cable with any other equipment as it is designed only for this unit. Do not use the AC cable from other equipment with this unit.

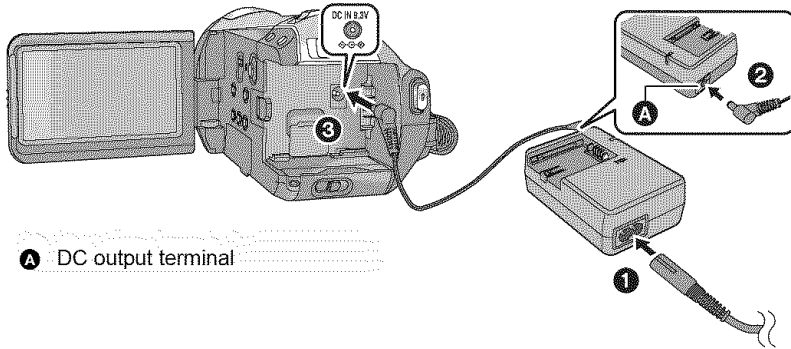

A DC output terminal

1 Connect the AC cable to the AC adaptor and the AC outlet.

2 Connect the DC cable to the AC adaptor.

3 Connect the DC cable to the DC input terminal [DC IN 9.3V].

This unit (an SDHC compatible device) is compatible with both SD Memory Cards and SDHC Memory Cards. You cannot use SDHC Memory Cards on devices that are only compatible with SD Memory Cards. When using an SDHC Memory Card on another device, confirm that the device supports the SDHC Memory Card.

Cards that you can use with this unit

Card type	Capacity	Motion picture recording We recommend using SD cards conforming to Class 4 or higher of the SD Speed Class Rating* or the following SD cards made by Panasonic for motion picture recording.	Still picture recording
SD Memory Card	8 MB 16 MB	Cannot be used.	Can be used.
	32 MB 64 MB 128 MB 256 MB 512 MB	Cannot be guaranteed in operation. The recording may suddenly stop during motion picture recording depending on the SD card you use. (→ 37)	
	1 GB	RP-SDV01G	
	2 GB	RP-SDV02G, RP-SDM02G	
	SDHC Memory Card	4 GB	
	8 GB	RP-SDV08G	
	16 GB	RP-SDV16G	

* The SD Speed Class Rating is the speed standard for successive writes.

Use this unit to format SD cards. (→ 77)
Do not format an SD card using any other equipment such as a PC. The card may not be used on this unit.

- 4 GB or more Memory Cards that do not have the SDHC logo are not based on SD Memory Card Specifications.
- When the write-protect switch **A** on SD card is locked, no recording, deletion or editing will be possible on the card.

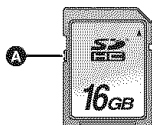

- Keep the Memory Card out of reach of children to prevent swallowing.

Inserting/removing an SD card

Caution:

If the SD card is inserted or removed while the power is on, this unit may malfunction or the data recorded on the SD card may be lost.

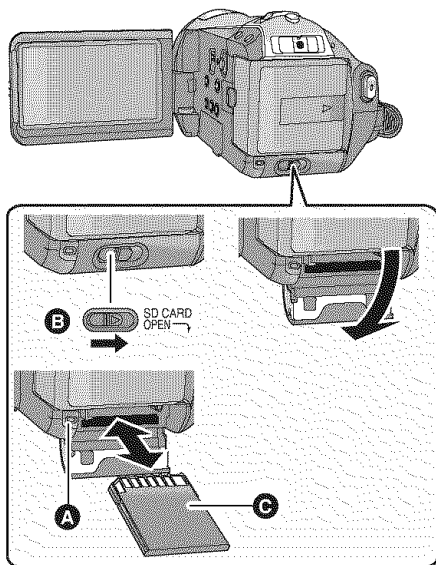

Card access lamp [ACCESS]

- When this unit is processing data, the access lamp **A** lights up.

1 Set the mode switch to OFF. (→ 26)

- Check that the status indicator has gone off.

2 Open the SD card cover while sliding the SD CARD OPEN lever **B**.

3 Insert/remove the SD card.

- Face the terminal side **C** in the direction shown in the illustration and press it straight in as far as it will go.
- Press the center of the SD card and then pull it straight out.

4 Securely close the SD card cover.



- Securely close it until it clicks.

First, format the SD card if one which has been used on another device is going to be used for the first time on this unit. (→ 77) When the SD card is formatted, all of the recorded data is deleted. Once the data is deleted, it cannot be restored. Copy valuable data onto a PC, DVD disc etc. before proceeding with the formatting. (→ 86, 96)

- Do not touch the terminals on the back of the SD card.
- Electrical noise, static electricity or the failure of this unit or the SD card may damage or erase the data stored on the SD card. We recommend saving the important data recorded on this unit to a PC, DVD disc etc. (→ 86, 96)
- When the card access lamp is lit, do not:
 - Remove the SD card
 - Operate the mode switch
 - Turn the unit off
 - Insert and remove the USB cable
 - Expose the unit to vibrations or shock
- Performing the above while the lamp is on may result in damage to data/SD card or this unit.

Selecting a mode (Turning the unit on/off)

Operate the mode switch to recording, playback or power OFF.

Turn on the power by sliding the mode switch to  or  while pressing the lock release button **A.**

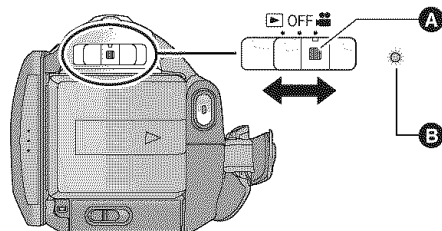

- Operate the mode switch while at the same time pressing in the lock release button if changing from OFF to another mode.
- Status indicator **B**



The status indicator lights and the power turns on.

- When the unit is turned on for the first time, a message asking you to set the date and time will appear. Select [YES] and set the date and time. (→ 30)

To turn off the power

Set the mode switch to OFF.

The status indicator goes off and the power turns off.

	Recording mode (→ 36, 41)
	Playback mode (→ 64, 69)
OFF	

Turning the power on and off with the LCD monitor

When the mode switch is set to , the power turns on when the LCD monitor opens and turns off when the LCD monitor closes.

■ To turn on the power

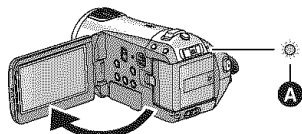

The status indicator **A** lights.

■ To turn off the power

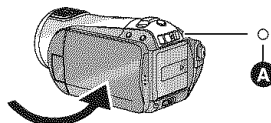

The status indicator **A** goes off.

Set the mode switch to OFF when this unit is not being used.

Using the menu screen

Operate the displayed menu screens with the cursor button.

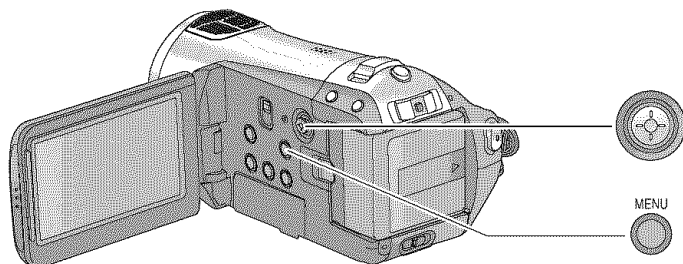

1 Press the MENU button.



- The menu displayed differs depending on the position of the mode switch.

2 Select the top menu **A** and move the cursor button right or press the cursor button.

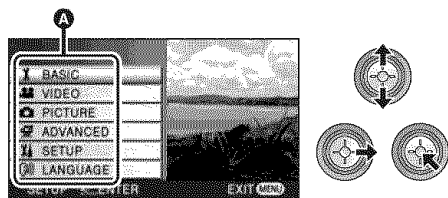

3 Select the submenu item **B** and move the cursor button right or press the cursor button.

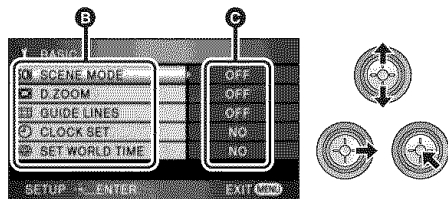

C Current settings on menus

4 Select the desired setting and press the cursor button to enter the selection.

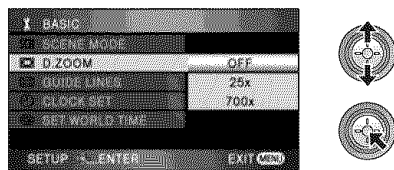

- Move the cursor button left to return to the previous screen. You can set other items continuously.

5 Press the MENU button to exit the menu screen.



- The menu screen does not appear during recording or playing. You cannot start other operations while the menu screen is displayed.

Language selection

You can select the language on the screen display and the menu screen.

1 Press the **MENU** button, then select **[LANGUAGE]** and press the **cursor** button.

2 Select **[English]** and press the **cursor** button.

Menu list

Recording mode

■ [BASIC]

[SCENE MODE] (→ 59)
[D.ZOOM] (→ 44)
[GUIDE LINES] (→ 51)
[CLOCK SET] (→ 30)
[SET WORLD TIME] (→ 31)

■ [VIDEO]

[REC MODE] (→ 38)
[24pDIGITAL CINEMA] (→ 51)
[FADE COLOR] (→ 48)
[WIND CUT] (→ 52)
[MIC SETUP] (→ 52)
[MIC LEVEL] (→ 53)
[AGS] (→ 35)

■ [PICTURE]

[PICT.QUALITY] (→ 43)
[HI-SPEED BURST] (→ 54)
[FLASH] (→ 55)
[FLASH LEVEL] (→ 55)
[RED EYE] (→ 55)
[SHTR SOUND] (→ 56)

■ [ADVANCED]

[REC LAMP]

The recording lamp lights up during recording and flashes when the unit receives a signal from the remote control or when the self-timer is counting down. When this is set to [OFF], it does not light during recording.

[ZEBRA] (→ 56)
[COLOR BAR] (→ 56)
[MF ASSIST] (→ 60)
[AUTO SLOW SHTR] (→ 57)
[SHOOTING GUIDE] (→ 40)
[Digital Cinema Color] (→ 57)

■ [SETUP]

[FORMAT CARD] (→ 77)
[DISPLAY]

The screen indications are selected as shown in the illustration below.

[OFF]

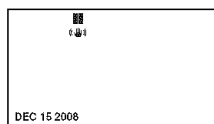

[ON]

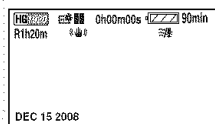

[DATE/TIME] (→ 30)
[DATE FORMAT] (→ 30)
[POWER SAVE]

[OFF]:

The power saving function is not activated.

[5 MINUTES]:

When about 5 minutes have passed without any operation, this unit automatically turns off to save battery life.

- When using the AC adaptor, connecting the unit to a PC, printer or DVD burner or PRE-REC is used, the power saving function will not activate.

[QUICK START] (→ 39)

[BEEP SOUND]

This allows operations such as starting and ending recording to be signaled by a beep.

1 Beep

When you start recording
When you turn on the power
When this unit is recognized by the PC or the printer, etc.

2 Beeps

When you pause recording
When you turn off the power

2 Beeps for 4 times

When an error occurs. Check the sentence displayed on the screen. (→ 111)

[LCD SET] (→ 32)

[COMPONENT OUT] (→ 82)

[HDMI RESOLUTION] (→ 81)

[VIERA Link] (→ 83)

[TV ASPECT] (→ 80)

[INITIAL SET]

Set to [YES] for changing the menu settings back to the default condition.

(The language setting cannot be changed back to the default condition.)

[DEMO MODE]

This item is used to start the unit demonstration.

(Only when the mode switch is at the  position)

If [DEMO MODE] is switched [ON] when there is no SD card inserted, the demonstration automatically starts. If any operation takes place, the demonstration is canceled.

However if no operations take place for approx. 10 minutes, the demonstration automatically starts again. To stop the demonstration, set [DEMO MODE] to [OFF] or insert an SD card.

■ [LANGUAGE] (→ 28)

Playback mode

([] motion picture playback)

■ [VIDEO SETUP]

[REPEAT PLAY] (→ 68)

[RESUME PLAY] (→ 68)

[SCENE PROTECT] (→ 75)*1

[GUIDE LINES] (→ 51)

■ [EDIT SCENE]*1

[DIVIDE] (→ 74)

[DELETE] (→ 73)

■ [DISC SETUP]*2

[FORMAT DISC] (→ 91)

[AUTO PROTECT] (→ 91)

[INFORMATION] (→ 91)

- For any other menus that are not described above, refer to menus with the same names for the recording mode.

([] still picture playback)

■ [PICT. SETUP]*1

[SCENE PROTECT] (→ 75)

[DPOF SET] (→ 76)

[DELETE] (→ 73)

■ [SETUP]

[FORMAT DISC] (→ 91)*2

- For any other menus that are not described above, refer to menus with the same names for the recording mode and motion picture playback.

*1 When the disc playback tab [] is selected while a DVD burner (optional) is connected, or when [INTEL. SCENE] (→ 67) is selected, this does not appear.

*2 Only when the disc playback tab [] is selected while a DVD burner (optional) is connected, this appears.

When the unit is turned on for the first time, a message asking you to set the date and time will appear. Select [YES] and perform steps 2 to 4 below to set the date and time.

◆ Operate the mode switch to select



1 Select the menu. (→ 27)

[BASIC] → [CLOCK SET] → [YES]

2 Select the date or time to be set, then set the desired value with the cursor button.



- The year will change as follows: 2000, 2001, ..., 2039, 2000, ...
- The 12-hour system is used to display the time.
- [] appears on the right top of the screen when [SET WORLD TIME] (→ 31) is set to [HOME], while [] appears when it is set to [DESTINATION].

3 Press the cursor button to enter the selection.

- The clock function starts at [00] seconds when the cursor button is pressed.

4 Press the MENU button to finish the setting.

- Check the date and time displayed.

Changing the date and time display mode

Select the menu. (→ 27)

[SETUP] → [DATE/TIME] → desired display style

- You can also show or change the date and time display by repeatedly pressing the DATE/TIME button on the remote control.

[DATE]

DEC 15 2008

[D/T]

DEC 15 2008 3:30PM

[OFF]

Changing the date format

Select the menu. (→ 27)

[SETUP] → [DATE FORMAT] → desired display style

Display style	Screen display
[Y/M/D]	2008. 12. 15
[M/D/Y]	DEC 15 2008
[D/M/Y]	15. 12. 2008

- To set daylight saving time, select the daylight saving time in [HOME] for [SET WORLD TIME] after setting the clock.
- The date and time function is driven by a built-in lithium battery.
- If the time display becomes [- -], the built-in lithium battery needs to be charged. Use the following steps to charge the battery.

To recharge the built-in lithium battery

- Connect the AC adaptor or attach the battery to this unit, and the built-in lithium battery will be recharged. Leave the unit as it is for approx. 24 hours and the battery will maintain the date and time for approx. 6 months. (The battery is still being recharged even if the mode switch is set to OFF.)

World time setting (Displaying the time of the travel destination)

It is possible to display and record the time at the travel destination by selecting your home region and the travel destination.

1 Select the menu. (→ 27)

[BASIC] → [SET WORLD TIME] → [YES]

- If the clock is not set, adjust the clock to the current time. (→ 30)
- When the [HOME] (your home region) is not set, such as the time for the initial settings, the message appears. Press the cursor button to move to Step 3.

2 (Only when setting your home region)

Select [HOME] with the cursor button.

3 (Only when setting your home region)

Select your home region and enter the selection with the cursor button.



- The current time appears on the left top of the screen. The time difference from GMT (Greenwich Mean Time) appears on the left bottom of the screen.
- If your home region season is summer, move the cursor button up. [☀️] appears and the summer time setting is turned on; the clock is set forward by one hour. Move the cursor button up again to return to the normal time setting.

4 (Only when setting the region of your travel destination)

Select [DESTINATION] and press the cursor button.

- When the home region is set for the first time, the screen for selecting travel destination

appears after setting the home region successively. If the home region has already been set once, execute the menu operation for Step 1.

5 (Only when setting the region of your travel destination)

Select your travel destination and enter the selection with the cursor button.



- The local time at the selected travel destination appears on the right top of the screen. The time difference between the travel destination and the home region appears on the left bottom of the screen.
- If the travel destination season is summer, move the cursor button up. [☀️] appears and the summer time setting is turned on; the clock is set forward by one hour. Move the cursor button up again to return to the normal time setting.
- Close the setting by pressing the MENU button. [✂️] appears and the time of the travel destination is indicated.

To return the display to the home setting

Set the home region using Step 1 to 3, and close the setting by pressing the MENU button.

- If you cannot find your travel destination in the area shown on the screen, set it by using the time difference from your home region.

- These settings will not affect the images actually recorded.

Increasing the brightness of the LCD monitor

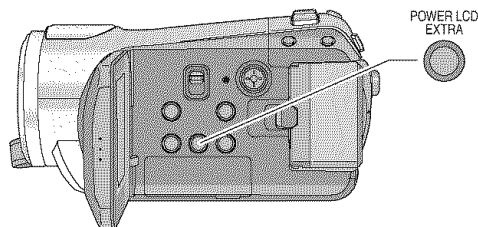

POWER LCD EXTRA button

Each time the POWER LCD EXTRA button is pressed, the indication changes by one setting in the following order: [☀️] → [🌙] → setting canceled (standard)

- If you use the AC adaptor, the [☀️] indication appears and the screen becomes brighter automatically when the power is turned on.

Adjusting the brightness and the color level of the LCD monitor

1 Select the menu. (→ 27)

[SETUP] → [LCD SET] → [YES]

2 Select the item with the cursor button.



[BRIGHTNESS]:

Brightness of the LCD monitor

[COLOR]:

Color level of the LCD monitor

3 Press the cursor button to make the adjustment.



- After adjustments are made if no operations are performed for about 2 seconds, the bar will disappear.
- Press the MENU button to exit the menu screen.

Recording Yourself

- ◆ Operate the mode switch to select .

Rotate the LCD monitor towards the lens side.

- The image is horizontally flipped as if you see a mirror image. (However the image recorded is the same as a normal recording.)

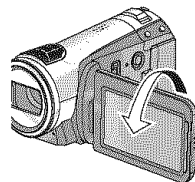

- Only some indications will appear on the screen. When [!] appears, return the direction of the LCD monitor to normal position and check the warning/alarm indication. (→ 111)

Preparation

Recording

Playback

Backup

With a PC

Others

- 34 Recording (Basic)
- 47 Recording (Advanced)

■ Basic camera positioning

- When you are outdoors, record pictures with the sunlight behind you. If the subject is backlit, it will become dark in the recording.
- When recording, make sure your footing is stable and there is no danger of colliding with another person or object.

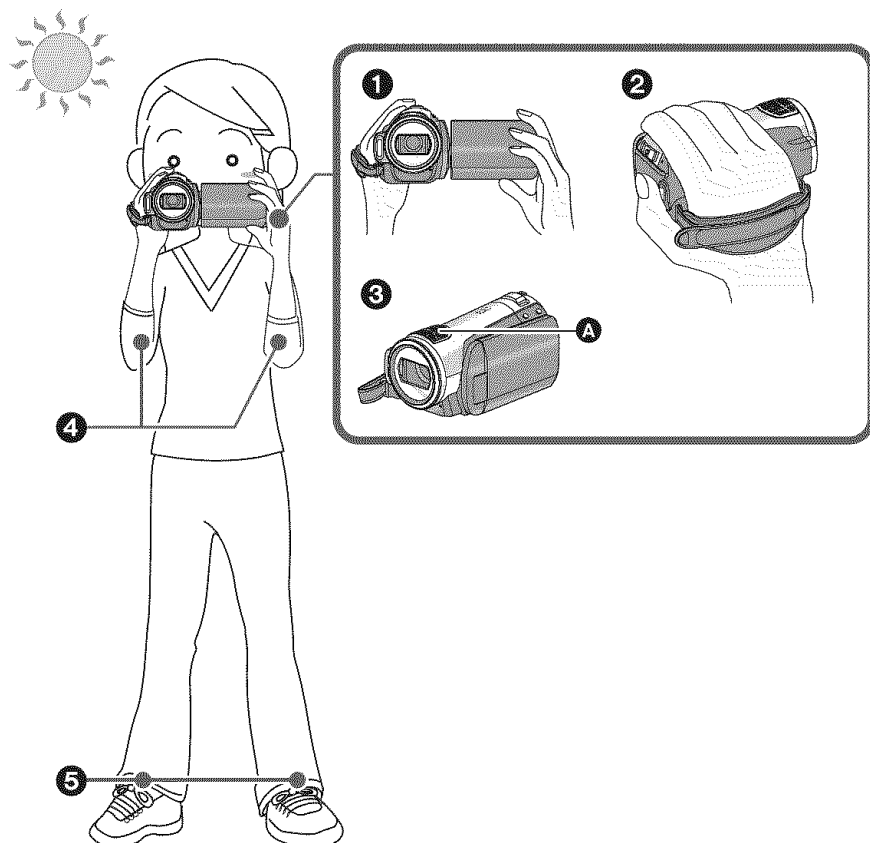

- 1 Hold the unit with both hands.
- 2 Put your hand through the grip belt.
- 3 Do not cover the microphones **A**.
- 4 Keep your arms near your body.
- 5 Separate your legs for better balance.

About auto mode

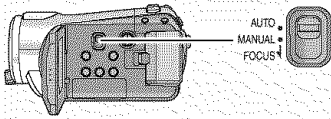

Color balance (white balance) and focusing are adjusted automatically.

Depending on the brightness of the subject etc., the aperture and shutter speed are automatically adjusted for an optimum brightness.

(The shutter speed is adjusted to a maximum of 1/250 in recording mode.)

- Automatic white balance (→ 127)
- Auto focus (→ 127)
- Color balance and focus may not be adjusted automatically depending on light sources or scenes. If so, manually adjust these settings. (→ 59)

Auto Ground-Directional Standby (AGS)

If the unit continues to be tilted upside down from the normal horizontal position while recording motion pictures, it is automatically put into recording pause.

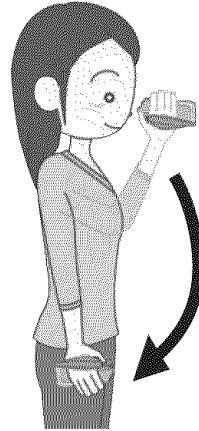

◇ Operate the mode switch to select



Select the menu. (→ 27)

[VIDEO] → [AGS] → [ON]

- The AGS function may activate and cause the unit to pause the recording if you are recording a subject right above or right below you. In these cases, set [AGS] to [OFF] then continue the recording.
- Use the recording start/stop button to pause the recording.

VIDEO

This unit records high definition images that are compatible with the AVCHD format on an SD card. Sound is recorded with the Dolby Digital 5.1 Creator.

Use an SD card that can be used for motion picture recording. (→ 24)

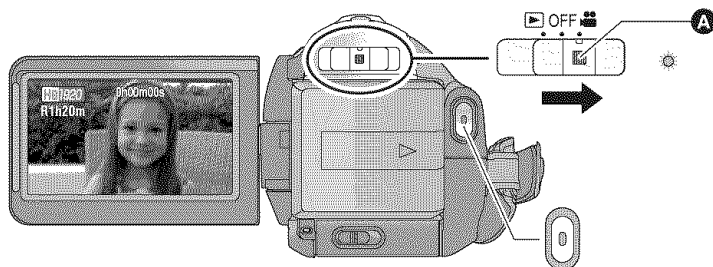

- Operate the mode switch while at the same time pressing in the lock release button **A** if changing from OFF to another mode.

1 Operate the mode switch to select and open the LCD monitor.



- It is impossible to start recording when closing the LCD monitor.

2 Press the recording start/stop button to start recording.



- While recording is in progress, the recording will not stop even if the LCD monitor is closed.

3 Press the recording start/stop button again to pause recording.

-  and  are red during recording. Do not move this unit until  is green.

About the compatibility of the recorded motion pictures

- They are not compatible with devices other than those that support AVCHD. Images cannot be played with equipment that does not support AVCHD (ordinary DVD recorders). Confirm that your equipment supports AVCHD by referring to the operating instructions.
- There are some cases where the recorded motion pictures cannot be played back, even if the device supports AVCHD. In such cases, play the recorded motion picture with this unit instead.

- The images recorded between pressing the recording start/stop button to start recording and pressing it again to pause recording become one scene.

- When about 5 minutes have passed without any operation in recording pause, the unit automatically turns off to prevent the battery from running down. When you want to use the unit, turn it on again. This power save feature can also be set to [OFF]. ([POWER SAVE]: → 28)
- (The maximum number of recordable pictures on a single SD card)
Maximum number of recordable scenes: 3998
Maximum number of recordable scenes with different dates: 200 (→ 67)
When either of them reaches to the maximum limit, more scenes cannot be recorded.
- When recording motion pictures, do not remove the battery or disconnect the AC adaptor. Also, do not remove the SD card while the card access lamp lights up. If you do either of the above, the recovery operation will begin when the SD card is next inserted or the power is turned back on. (→ 112)

■ Screen indications in the recording mode

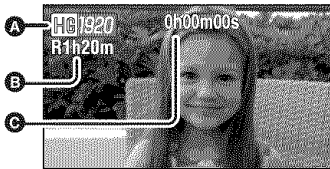

- A** Recording mode
- B** Remaining time left for recording
(When the remaining time is less than 1 minute, [R0h00m] flashes red.)
- C** Recording time elapsed
Each time the unit is put into recording pause, the counter display will be reset to "0h00m00s".

When motion picture recording stops suddenly

For some SD cards, the message appears suddenly, and recording stops.

Use a Panasonic SD card or another SD card which can be used to record motion pictures. (→ 24)

When the unit stops while a usable SD card for recording motion pictures (→ 24) is used, the data writing rate has deteriorated.

We recommend formatting the SD card being used. (→ 77) When an SD card is formatted, all the data recorded on it will be deleted so copy valuable data to the PC prior to formatting. (→ 96)



Recording modes/approximate recordable time

Switch the picture quality of the motion pictures to be recorded.

Select the menu. (→ 27)

[VIDEO] → [REC MODE] → desired setting

	Capacity	HA* ¹	HG* ²	HX* ³	HE* ⁴
SD card	1 GB	7 min	9 min	14 min	21 min
	2 GB	15 min	20 min	30 min	45 min
	4 GB	30 min	40 min	1 h	1 h 30 min
	8 GB	1 h	1 h 20 min	2 h	3 h
	16 GB	2 h	2 h 40 min	4 h	6 h

1 HA (1920×1080): Motion pictures can be recorded with the highest picture quality.

*2 HG (1920×1080): Motion pictures can be recorded with high picture quality.

*3 HX (1920×1080): Motion pictures can be recorded with normal picture quality.

*4 HE (1440×1080): Motion pictures can be recorded for a longer time.

* This means the highest quality for this unit.

- The recording is in high definition picture quality no matter what recording mode is used to record.
 - This unit records in VBR (Variable Bit Rate). VBR recording automatically varies the bit rate (amount of data in a fixed time) depending on the subject being recorded. This means if a recording with a lot movements is recorded, the recording time is reduced.
-
- Recordable time using the battery (→ 22)
 - Mosaic-pattern noise may appear on a playback image in the following cases.
 - When there is a complicated pattern in the background
 - When the unit is moved too fast
 - When a subject with sharp movements has been recorded (Particularly if it has been recorded in HE mode.)
 - Many repeated recording and deletion of motion pictures may reduce the usable time for recording on an SD card. In that case, format the SD card using this unit. Since all data recorded on the SD card will be deleted once the SD card has been formatted, save important data to your PC. (→ 96)

Quick start

This unit will resume recording/pause mode about 0.6 seconds after the LCD monitor is reopened.

- When in quick start standby mode about 60% of the power used in recording pause mode is being consumed, so the recording time will be reduced.

1 Select the menu. (→ 27)

[SETUP] → [QUICK START] → [ON]

2 Close the LCD monitor while the mode switch is set to .

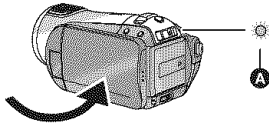

The status indicator **A** flashes green and the unit goes into quick start standby mode.

- The lens cover does not close.

3 Open the LCD monitor.

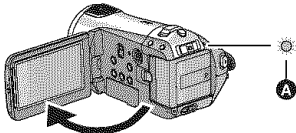

The status indicator **A** lights red and the unit is put into recording pause approx. 0.6 seconds after it is turned on.

- Set [QUICK START] to [OFF] to cancel the quick start mode.
- Quick start standby mode is canceled if
 - about 5 minutes has elapsed
 - mode switch is set to 
 - unit is turned off
- In the 24p digital cinema setting, the required time for the quick start operation is slightly longer than 0.6 seconds.
- In the quick start mode, it may take some time for automatic white balance to adjust, if the scene being recorded has a light source different from the scene last recorded. (When the MagicPix function is used, however, the white balance of the scene last recorded is retained.)

- In the quick start mode, the zoom magnification becomes 1× and the picture size may differ from what it was before quick start standby mode.
- If [POWER SAVE] (→ 28) is set to [5 MINUTES] and the unit automatically goes into quick start standby mode, close the LCD monitor and then open it again.
- If the unit is exposed to vibration or shock, the time for the quick start mode to start may be slightly longer than 0.6 seconds.

PRE-REC

This prevents you from missing a shot.

This allows recording of the pictures and sound to start approximately 3 seconds before the recording start/stop button is pressed.

1 Press the PRE-REC button.

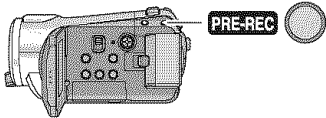

[PRE-REC] appears on the screen and the unit repeats the update by recording motion pictures for about 3 seconds onto the built-in memory and then deleting them.

- Aim this unit at the subject and position it securely.
- Press the PRE-REC button again to cancel the setting.

2 Press the recording start/stop button to start recording.

- Images and audio are recorded for about 3 seconds before pressing the recording start/stop button.
 - There is no beep sound.
 - After recording starts, the PRE-REC setting is canceled.
 - To use the PRE-REC function again, press the PRE-REC button again.
-
- PRE-REC is canceled in the following cases.
 - If you operate the mode switch.
 - If you open the SD card cover.
 - If you press the MENU button.
 - If you turn the unit off.
 - When the remaining time left for recording motion pictures is less than 1 minute, PRE-REC cannot be set.
 - If you start recording less than 3 seconds after pressing the PRE-REC button, or while the PRE-REC indication flashes within about 3 seconds after initiating the quick start operation, motion pictures taken 3 seconds before pressing the recording start/stop button cannot be recorded.
 - When the recording start/stop button is pressed, image shake and operation sound may be recorded.

- The image when pressing the recording start/stop button appears in thumbnail view, and it is different from the image when starting playback.

Shooting guide

The messages instructing how to record in dark places and diminish camera shake are displayed for recording better images.

Select the menu. (→ 27)

[ADVANCED] → [SHOOTING GUIDE] → [ON]

- This function's default setting is [ON].

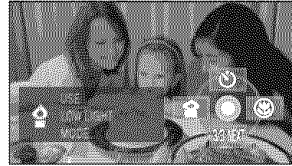

A message appears in the following cases.

When you move the unit quickly:

When "CAMERA PANNING IS TOO FAST." appears, move the unit slowly while recording.

When the unit is shaken:

When "USE O.I.S." appears, set [O.I.S.] to [ON]. (When the image stabilizer function is on, the message does not appear.)

When the image contrast is too strong such as when using backlight:

When "USE INTELLIGENT CONTRAST." appears, select [] on the operation icons. (When the face detection & AE mode is on, the message does not appear.)

When the scene is dark:

When "USE LOW LIGHT MODE." appears, select [] on the operation icons.

- Set to [OFF] to turn off the message indication.

-
- In some recording conditions, messages may not appear.
 - A message recommending cancellation of Intelligent Contrast Control or Low Light also appears.
 - Once the message recommending turning on the Intelligent Contrast Control or Low Light appears, it will not appear again until the recording starts or stops.
 - When the AUTO/MANUAL/FOCUS switch is set to MANUAL, messages warning that the image contrast is too strong (such as backlight) or that the scene is too dark will not appear.

Recording still pictures

PHOTO

The number of pixels recorded for still pictures is 1920×1080. Still pictures can also be recorded while recording motion pictures.

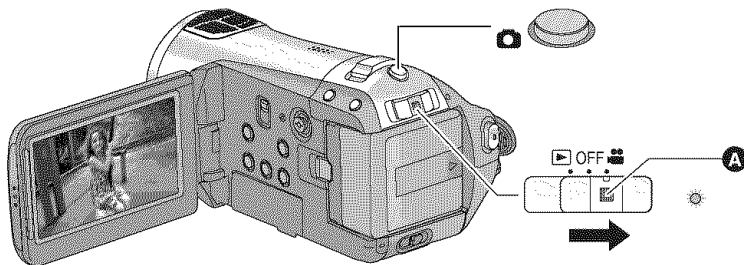



- Operate the mode switch while at the same time pressing in the lock release button **A** if changing from OFF to another mode.

1 Operate the mode switch to select and open the LCD monitor.

2 Press the button halfway. (For auto focus only)

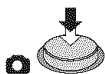
Focus indication appears and the unit focuses on the subject automatically. (Focus on a subject manually when it is not easily focused automatically.)



- If you set [O.I.S.] (→ 45) to on, then the image stabilizer function will be more effective.
([MEGA] ) (MEGA optical image stabilizer) will be displayed.)

Focus indication:

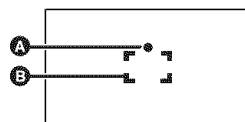



- A** Focus indication
○ (The white lamp flashes.):
Focusing
● (The green lamp lights up.):
When in focus
No mark:
When focusing is unsuccessful.
- B** Focus area (area inside brackets)

3 Press the button fully.

- In order to take better still pictures, the screen will brighten when the  button is fully pressed.



To record still pictures clearly









- While recording motion pictures or during the PRE-REC operation, the following arrangements are applied so that motion picture recording takes preference over still picture recording. For vivid still pictures, we recommend pausing motion picture recording and taking still pictures after releasing the PRE-REC mode.
 - Image quality is different from ordinary still pictures.
 - Pressing the  button halfway is disabled.
 - The remaining usable capacity (number of pictures that can be taken) indication does not appear.
- You can record stable pictures without shaking by using a tripod and the remote control. (When a remote control is used, pressing the  button halfway is disabled.)

• For information about the number of recordable still pictures (→ 43)

- The sound cannot be recorded while recording still pictures.
- The edges of still pictures recorded on this unit with a 16:9 aspect ratio may be cut at printing. Check the printer or photo studio before printing.

■ About the screen indications when the button is pressed



- : Flash (→ 55)
- : Flash level (→ 55)
- : Red eye reduction (→ 55)
- : Quality of still pictures (→ 43)
- : Size of still pictures
- : Remaining number of still pictures (Flashes in red when [0] appears.)
- : Card indication (→ 109)
- : MEGA optical image stabilizer (→ 45)

■ About the focus indication

- The focus indication indicates the status of the auto focus.
- The focus indication does not appear in manual focus mode.
- You can record still pictures even if the focus indication does not appear, but pictures may be recorded without being focused.
- The focus indication does not appear or has difficulty focusing in the following cases.
 - When the zoom magnification is high.
 - When the unit is shaken.
 - When the subject is moving.
 - When the subject stands in front of a light source.
 - When close subjects and far subjects are included in the same scene.
 - When the scene is dark.
 - When there is a bright part in the scene.
 - When the scene is filled with only horizontal lines.
 - When the scene lacks contrast.
 - When the MagicPix function is used.

■ About the focusing area

When there is a contrasting object ahead or behind the subject in the focus area, the subject may not be focused. If so, move the contrasting object out of the focus area.



- The focusing area is not displayed when the digital zoom (more than approx. 10×) is used.

Picture quality



Selecting the picture quality.



Select the menu. (→ 27)

[PICTURE] → [PICT.QUALITY] → desired setting

-  : Still pictures with a high picture quality are recorded.
-  : Priority is given to the number of still pictures recorded. Still pictures are recorded in normal picture quality.
- If the [PICT.QUALITY] is set to [], mosaic-pattern noise may appear on a playback image depending on the picture content.

Number of recordable pictures

	Picture size	2.1M (1920×1080)	
			
SD card	8 MB	4	6
	16 MB	10	17
	32 MB	20	32
	64 MB	47	74
	128 MB	94	150
	256 MB	200	320
	512 MB	410	640
	1 GB	820	1290
	2 GB	1670	2630
	4 GB	3290	5160
	8 GB	6690	10520
16 GB	13470	21170	

- The number of recordable pictures depends on whether [] and [] are used together and on the subject being recorded.
- The numbers shown in the table are approximations.

VIDEO PHOTO

The maximum optical zoom ratio is 10 \times .

◇ Operate the mode switch to select

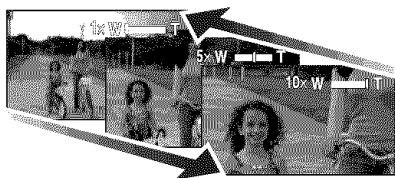
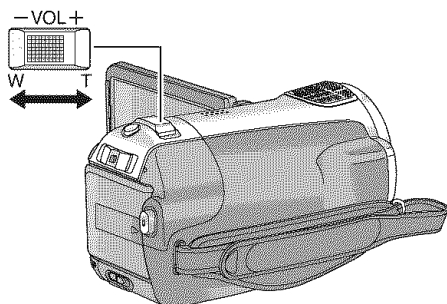

2.3 seconds. (The zoom speed does not vary when operating with the remote control.) When the zoom speed is high, the subject may not be focused easily.

Digital zoom function

If the zoom magnification exceeds 10 \times , then the digital zoom function will be activated. The maximum magnification provided by the digital zoom can be selected.

Select the menu. (→ 27)

[BASIC] → [D.ZOOM] → desired setting

[OFF]: Optical zoom only (Up to 10 \times)

[25 \times]: Up to 25 \times

[700 \times]: Up to 700 \times

- If [25 \times] or [700 \times] is selected, the digital zoom range is displayed in blue while zooming.
- The larger the digital zoom magnification, the more the image quality is degraded.

Zoom lever

T side:

Close-up recording (zoom in)

W side:

Wide-angle recording (zoom out)

- The zoom speed varies depending on the range over which the zoom lever is moved.

- If you take your finger off the zoom lever during zoom operation, the operation sound may be recorded. When returning the zoom lever to the original position, move it quietly.
- When the zoom magnification is 10 \times , the subjects are focused at about 1.2 m (3.9 feet) or more.
- When the zoom magnification is 1 \times , this unit can focus on a subject approx. 4 cm (1.6") away from the lens. (Macro function)
- If the zoom lever is pushed to the end, you can zoom from 1 \times up to 10 \times in as fast as approx.

VIDEO PHOTO

Reduces the image shaking (jitter) due to hand movement.

◇ Operate the mode switch to select  .

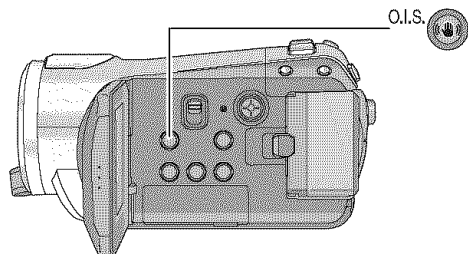

Optical image stabilizer button

[, O.I.S.]

Press this button to switch on/off the image stabilizer function.

• [, O.I.S.] appears on the screen.

O.I.S.: Optical Image Stabilizer

- This function's default setting is [ON].
- In still picture recording mode, pressing the  button halfway increases the effect of the image stabilizer function. (MEGA optical image stabilizer)
- When a tripod is used, we recommend that you turn the image stabilizer off.
- In the following cases, the image stabilizer function may not work effectively.
 - When the digital zoom is used
 - When the unit is shaken greatly
 - When you record a moving subject while tracking it
 - When the conversion lens is used

VIDEO PHOTO

When a subject is backlit and appears darker, this function detects the face and automatically adjusts the brightness and picture quality so that the face is recorded clearly.

◇ Operate the mode switch to select .

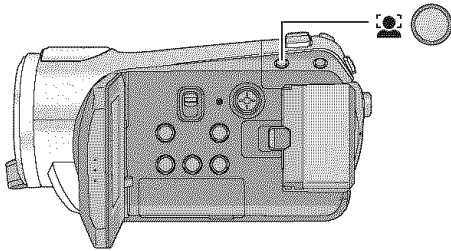



Face detection & AE button

Press this button to switch on/off the face detection & AE mode.

- [] appears on the screen.

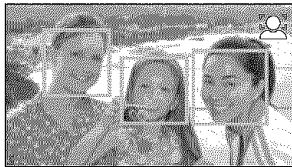
In the face detection & AE mode, detected faces appear with frames. Up to 5 frames are indicated. Larger faces and faces nearer to the center of the screen take preference over others. Faces that do not appear completely on the screen are not detected.



- In the following cases, the function may not operate properly even if faces are detected. If this occurs, turn off this function.
 - Nonhuman subjects are recognized as faces.
 - When the brightness or quality cannot be adjusted clearly since scenes are extremely dark, or the areas around the faces or the background is extremely bright.
- There is no function to focus preferentially on a face that is detected.
- Since the brightness of the entire image is adjusted to record faces more vividly, brightness may change suddenly or images may flicker under some recording conditions.
- When the face detection frame disappears due to zooming, the brightness may change suddenly or the images may flicker.
- The face detection frame disappears when the  button is pressed halfway.
- In the following case, faces may not be detected in some recording conditions.
 - Faces are not full-faces
 - Faces tilt
 - Faces are extremely bright or dark
 - Shadows on faces are a few
 - Faces are not completely exposed (for instance wearing sunglasses)
 - The size of a face is small on the screen.
 - The subject moves quickly.
 - When the hand shakes
 - When the digital zoom is used
 - When the unit is tilted

Recording functions of operation icons

Select the operation icons to add different effects to the images to be recorded.

◇ Operate the mode switch to select .

1 Press the cursor button, and icons will be displayed on the screen.

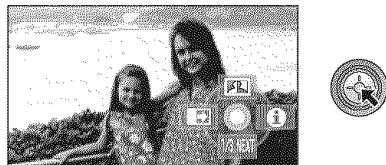

- The indication changes each time the cursor button is moved down.
- The operation icon appears or disappears each time the cursor button is pressed.











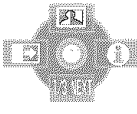

2 (e.g. Intelligent contrast control)
Select an icon with the cursor button.

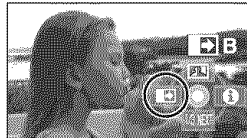

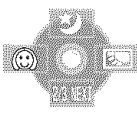

- Select the icon again to cancel the function. (Refer to page 48 to cancel help mode, and page 49 to cancel self-timer.)

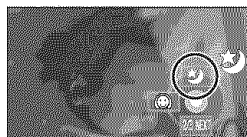



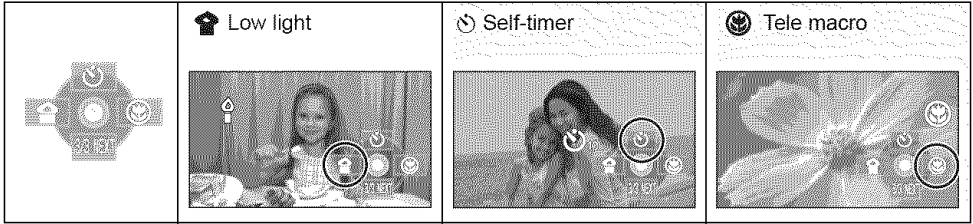

Operation icons





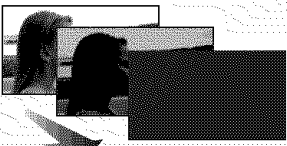



Fade, Intelligent contrast control, Help mode, Soft skin mode, MagicPix, Backlight compensation, Low light, Self-timer, Tele macro

	 Fade	 Intelligent contrast control	 Help mode
			
	 Soft skin mode	 MagicPix	 Backlight compensation
			



- The shaded operation icons are not displayed while recording.
- If you turn off the power or set the mode switch to , help mode, MagicPix, backlight compensation, self timer and tele macro functions are canceled.
- If you turn off the power, the fade function is canceled.

Function	Effect
<p> Fade</p> <p style="text-align: right;">VIDEO</p> <p>(Fade in)</p>  <p>(Fade out)</p> 	<p>When you start recording, the image/audio gradually appears. (Fade in)</p> <p>When you pause recording, the image/audio gradually disappears. (Fade out)</p> <ul style="list-style-type: none"> • For fade out, the recording stops and the fade setting is canceled after the image and audio have disappeared completely. <p>■ To select the color for fade in/out</p> <p>Select the menu. (→ 27)</p> <p>[VIDEO] → [FADE COLOR] → [WHITE] or [BLACK]</p>
<p> Intelligent contrast control</p> <p style="text-align: right;">VIDEO PHOTO</p>	<p>This brightens parts that are in shadow and difficult to see and suppresses white saturation in bright parts at the same time. Both bright and dark parts can be recorded clearly.</p>
<p> Help mode</p> <p style="text-align: right;">VIDEO PHOTO</p>	<p>Select the icon of the function that you want to know with the cursor button and then an explanation of the selected icon scrolls at the bottom of the screen. (Only for icons that can be selected when the AUTO/MANUAL/FOCUS switch is set to AUTO in recording mode.)</p> <ul style="list-style-type: none"> • To exit the help mode, press the MENU button or select [END]. 

Function	Effect
 Soft skin mode VIDEO PHOTO	This makes skin colors appear softer for a more attractive appearance. This is more effective if you record a person closely from the torso up.
 MagicPix VIDEO PHOTO	This function allows you to record color images in very low light situations. (Minimum required illumination: approx. 1 lx)
 Backlight compensation VIDEO PHOTO	This makes the image brighter to prevent darkening of a backlit subject.
 Low light VIDEO PHOTO	This makes the scene brighter in dark conditions such as evening twilight.
 Self-timer PHOTO	<p>This is for recording still pictures using the timer.</p> <p>Each time the [⌚] icon is selected, the indication changes by one setting in the following order: [⌚10] → [⌚2] → setting canceled ⌚10: Records after 10 seconds ⌚2: Records after 2 seconds</p> <ul style="list-style-type: none"> • When the  button is pressed, a still picture is recorded after the [⌚10] or [⌚2] display and the recording lamp flashes for the time which has been set. • After recording, the self-timer is canceled. • In auto focus mode, if the  button is pressed halfway once and then fully, the lens focuses on the subject when the button is pressed halfway. • If the  button is pressed fully all at once, the lens focuses on the subject just before recording. • Depending on the time taken to bring the subject into focus, the recording may take longer than set to start. <hr/> <p>To stop the timer midway through Press the MENU button.</p>
 Tele macro VIDEO PHOTO	<p>This is for close-ups bringing only what you want to record into focus. By focusing only on the subject and blurring the background, the image can be impressive.</p> <ul style="list-style-type: none"> • The unit can focus on the subject at a distance of approx. 50 cm (20"). • If the magnification is 10× or less, then it is automatically set to 10×.

Fade:

- The thumbnails of scenes recorded using fade in become black (or white).

Intelligent contrast control:

- If there are extremely dark or bright parts or the brightness is insufficient, the effect may not be clear.

Help mode:

- When the help mode is used, functions cannot be set.
- When the help mode is used, motion pictures and still pictures cannot be recorded.

Soft skin mode:

- If the background or anything else in the scene has colors similar to the skin color, they will also be smoothed.
- If the brightness is insufficient, the effect may not be clear.
- If you record a person in the distance, the face may not be recorded clearly. In this case, cancel soft skin mode or zoom in on the face (close-up) to record.



MagicPix:

- **Recorded scene is seen as if frames were missed.**
- If set in a bright place, the screen may become washed out for a while.
- MagicPix function makes dark scenes that are usually invisible can be recorded in bright colors. For this reason, bright dots that are usually invisible may be seen, but this is not a malfunction.
- Attach this unit to a tripod, and you can record images free from vibration.
- In darker areas, auto focus may focus a bit slower. This is normal. If there is difficulty focusing with auto focus, manually adjust the focus.

Low light:

- The shutter speed is 1/30 or more. (When [24pDIGITAL CINEMA] is [ON], it is 1/24 or more.)
- Extremely dark scenes may not be able to be recorded finely.

Self-timer:

- The self-timer standby mode is canceled when you press the recording start/stop button to start motion picture recording. Even if you press the recording start/stop button while the self-timer is counting down, motion picture recording is not possible.
- Setting the self-timer to  is a good way to prevent image shake when the  button is pressed while using a tripod etc.

Tele macro:

- The tele macro function is canceled when the zoom magnification becomes lower than 10×.
- If a sharper focus cannot be achieved, adjust the focus manually. (→ 60)



Recording functions of menus

Menus

Guide line, 24p digital cinema, Wind noise reduction, Microphone setup, Microphone level, HD hi-speed burst shooting, Built-in flash, Red eye reduction, Shutter sound, Zebra, Color bar, Auto slow shutter, Digital cinema color

◇ Operate the mode switch to select .

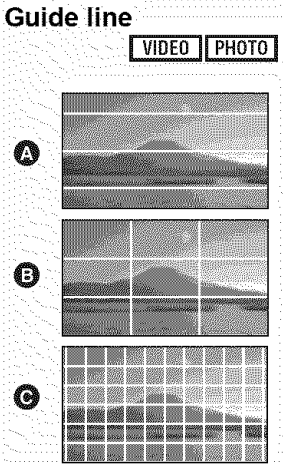

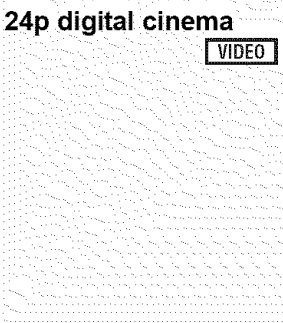
- Set to [OFF] when the menus are not used. (Set [MIC SETUP] to [SURROUND] and [MIC LEVEL] to [AUTO].)





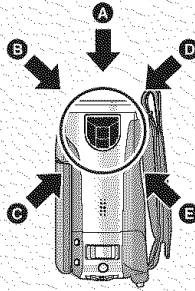
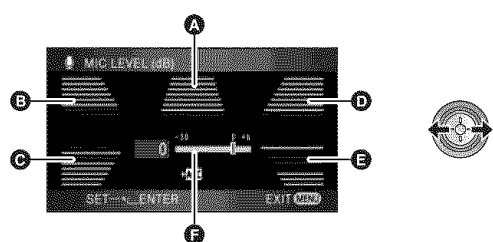
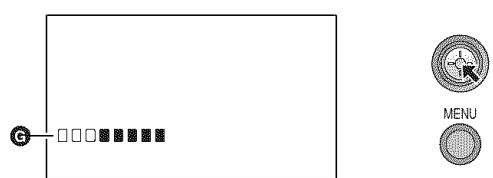



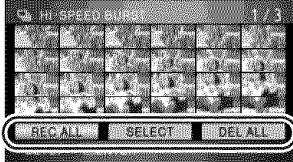
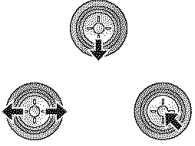
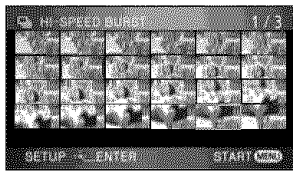
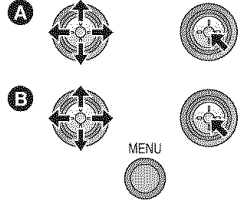

Function	Effect/Setting method
Guide line 	<p>You can check if the image is level while recording or playing back motion pictures and still pictures. The function can also be used to estimate the balance of the composition.</p> <p>A [HORIZONTAL] B [GRID1] C [GRID2]</p> <hr/> <p>Select the menu. (→ 27) [BASIC] → [GUIDE LINES] → desired setting</p> <p>(When  (motion picture playback) tab is selected while the mode switch is set to . (→ 64))</p> <p>[VIDEO SETUP] → [GUIDE LINES] → desired setting</p> <ul style="list-style-type: none"> • The guide lines do not appear on the images actually recorded.
24p digital cinema 	<p>Images recorded at a rate of 24 frames per second are the same frame rate as movie films.</p> <hr/> <ul style="list-style-type: none"> • Set the recording mode to HA or HG. (→ 38) <p>Select the menu. (→ 27) [VIDEO] → [24pDIGITAL CINEMA] → [ON]</p> <ul style="list-style-type: none"> • The shutter speed is 1/24 or more. (When [AUTO SLOW SHTR] is [OFF], it is 1/48 or more.) • In 24p digital cinema mode, the images are recorded at a rate of 24 frames per second so that the images may not appear as smooth as the images recorded at a rate of 60 frames per second when [24pDIGITAL CINEMA] is [OFF].

Function	Effect/Setting method
<p>Wind noise reduction</p> <p>VIDEO</p>	<p>This is for reducing the wind noise coming into the built-in microphones depending on the wind strength.</p> <hr/> <p>Select the menu. (→ 27) [VIDEO] → [WIND CUT] → [ON]</p> <ul style="list-style-type: none"> • This function's default setting is [ON].
<p>Microphone setup</p> <p>VIDEO</p> <p>[SURROUND]: Sound is recorded with 5.1 ch surround microphone.</p> <p>[ZOOM MIC]: Directivity of the microphone is synchronized with the zoom operation. Sounds near the front of the unit are recorded more clearly if you zoom in (close-up) and surrounding sounds are recorded more realistically if you zoom out (wide angle).</p> <p>[FOCUS MIC]: Directivity of the center is enhanced for recording audio near the front of the unit more clearly.</p>	<p>Directivity (sound sensitivity direction) of the built-in microphones can be adjusted.</p> <hr/> <p>Select the menu. (→ 27) [VIDEO] → [MIC SETUP] → desired setting</p> <ul style="list-style-type: none"> • This function's default setting is [SURROUND].



Function	Effect/Setting method
<p>Microphone level VIDEO</p> <p>AGC: Auto Gain Control [AUTO]: AGC is activated, and the recording level is adjusted automatically.</p> <p>[SET+AGC]: The desired recording level can be set. AGC will also be activated to reduce the amount of sound distortion.</p> <p>[SET]: AGC is not activated and so natural recording can be performed.</p> 	<p>When recording, the input level from the built-in microphones can be adjusted.</p> <hr/> <p>1 Select the menu. (→ 27) [VIDEO] → [MIC LEVEL] → [SET+AGC] or [SET]</p> <ul style="list-style-type: none"> Set [MIC LEVEL] to [AUTO] to set the microphone input level automatically. <p>2 Move the cursor button to adjust the microphone input level.</p>  <ul style="list-style-type: none"> A Center B Front left C Back left D Front right E Back right F Microphone input level <ul style="list-style-type: none"> A gain value for each of the 5 built-in microphones is displayed. (The input level of the microphones cannot be set individually.) Adjust the gain value so that the last 2 bars of the microphone input level are not red. (Otherwise, the sound is distorted.) Select a lower setting for gain value or set [MIC LEVEL] to [AUTO]. <p>3 Press the cursor button to set and then press the MENU button to finish the setting.</p>  <ul style="list-style-type: none"> G Microphone input level meter <ul style="list-style-type: none"> Microphone input level meter is displayed on the screen.

Function	Effect/Setting method
<p>HD hi-speed burst shooting</p> <p>PHOTO</p>	<p>72 still pictures are recorded at a rate of 24 per second.</p> <hr/> <p>1 Select the menu. (→ 27) [PICTURE] → [HI-SPEED BURST] → [ON]</p> <p>2 Press the  button.</p> <ul style="list-style-type: none"> Up to 72 still pictures can be taken in burst mode. ( flashes in red during recording.) <p>3 Select the setting to save with the cursor button and press the cursor button.</p>   <p>[REC ALL]: All pictures are stored. [SELECT]: Pictures in the selected range are stored. [DEL ALL]: No picture is stored.</p> <ul style="list-style-type: none"> Select the thumbnails on the right bottom of the screen with the cursor button and move the cursor button right to display the next page. <p>4 (Only when the [SELECT] is selected) Select the range of pictures that will be stored.</p>   <p>A Start point B Finish point</p> <ul style="list-style-type: none"> Select the start point and the finish point and enter them using the MENU button. When the confirmation message appears, select [YES] and press the cursor button. (Two or more pictures must be selected.)

Function	Effect/Setting method
<p>Built-in flash</p> <p style="text-align: right;">PHOTO</p>	<p>When the  button is pressed, the flash is activated and the picture will be recorded. Use the built-in flash in order to record still pictures in dark places.</p> <hr/> <p>Select the menu. (→ 27) [PICTURE] → [FLASH] → [AUTO] or [ON]</p> <ul style="list-style-type: none"> • This function's default setting is [AUTO]. • When the  button is pressed halfway, the flash indicator will appear in the bottom left corner of the screen. <p>[ON]:  [AUTO]:  [OFF]: </p> <ul style="list-style-type: none"> • When [AUTO] is set, the ambient brightness is automatically detected, and the flash will activate only when necessary. (If the flash is not necessary, the [] indicator will not appear when the  button is pressed halfway.) <p>■ To adjust the brightness of the flash</p> <p>Select the menu. (→ 27) [PICTURE] → [FLASH LEVEL] → desired setting</p> <p>[-]: Less brighter [±0]: Normal [+]: Much brighter</p>
<p>Red eye reduction</p> <p style="text-align: right;">PHOTO</p>	<p>Reduces the phenomena where human eyes become red from flashes.</p> <hr/> <p>Select the menu. (→ 27) [PICTURE] → [RED EYE] → [ON]</p>

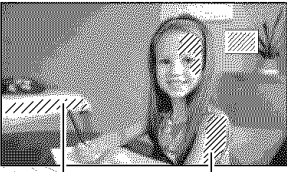
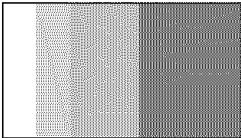
Function	Effect/Setting method
<p>Shutter sound</p> <p style="text-align: right;">PHOTO</p>	<p>You can add a shutter sound when recording still pictures.</p> <hr/> <p>Select the menu. (→ 27) [PICTURE] → [SHTR SOUND] → [ON] • This function's default setting is [ON].</p>
<p>Zebra</p> <p style="text-align: right;">VIDEO PHOTO</p>  <p>A Zebra pattern</p>	<p>Parts where white saturation (color saturation) is likely to occur (extremely brightly lit or shiny parts) are displayed with diagonal lines (zebra pattern).</p> <hr/> <p>Select the menu. (→ 27) [ADVANCED] → [ZEBRA] → [ON] • You can record an image with little white saturation if you manually adjust the shutter speed or brightness (iris/gain) (→ 62). • The zebra pattern does not appear on the images actually recorded.</p>
<p>Color bar</p> <p style="text-align: right;">VIDEO PHOTO</p> 	<p>This unit displays a 7 color bar which is useful for adjusting the picture quality of the TV or the external monitor.</p> <hr/> <p>Select the menu. (→ 27) [ADVANCED] → [COLOR BAR] → [ON]</p>

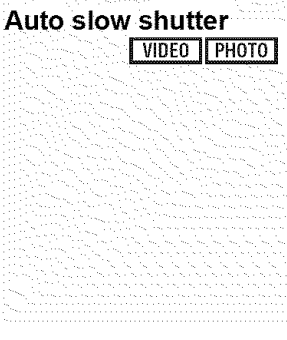
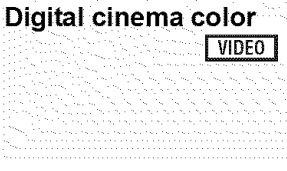
Function	Effect/Setting method
Auto slow shutter 	<p>You can record bright pictures even in dark places by slowing the shutter speed.</p> <hr/> <p>Select the menu. (→ 27) [ADVANCED] → [AUTO SLOW SHTR] → [ON]</p> <ul style="list-style-type: none"> • This function's default setting is [ON]. • The shutter speed is adjusted between 1/30 and 1/250 depending on the surrounding brightness. (When adjusting the shutter speed manually, it can be adjusted between 1/30 and 1/8000.) • If [AUTO SLOW SHTR] is set to [OFF], then the shutter speed will be set between 1/60 and 1/250. (When adjusting the shutter speed manually, it can be adjusted between 1/60 and 1/8000.)
Digital cinema color 	<p>Recording motion pictures with more vivid colors.</p> <hr/> <p>Select the menu. (→ 27) [ADVANCED] → [Digital Cinema Color] → [ON]</p> <ul style="list-style-type: none"> • For more realistic colors, use an HDMI mini cable with a TV that supports the x.v.Color™.

24p digital cinema:

- [Digital Cinema Color] is turned [ON] and is not changeable.
- Motion pictures recorded while this setting is turned to [ON] may not be played back properly with a player that does not support 24p.

Wind noise reduction:

- The sound quality may be changed if this function is activated in strong winds. However, the sound quality is automatically restored to the original quality when then the wind weakens.

Microphone setup:

- If [MIC SETUP] is set to [FOCUS MIC] or [ZOOM MIC] when zooming in (close-up), sounds from the surrounding area are suppressed and sound near the front of the unit is recorded. If you wish to record higher quality sound and maintain realism even when zooming in, for instance recording a music recital, we recommend setting [MIC SETUP] to [SURROUND].

Microphone level:

- When [MIC SETUP] is [ZOOM MIC], the volume will be different depending on the zoom rate. Set [MIC SETUP] to [SURROUND] or set the microphone input level after adjusting the zoom rate. (→ 53)





- The microphone input level meter shows the largest volume for the microphones.

HD hi-speed burst shooting:

- If this is turned to [ON], motion pictures cannot be recorded. The following functions are also disabled.
 - Changing the settings in [VIDEO] on the Menu.
 - PRE-REC
 - Pressing the  button halfway
 - Digital zoom
 - Fade
 - MagicPix
 - Low light
 - Built-in Flash
 - Auto slow shutter
 - Digital cinema color
 - Scene mode
 - Adjusting shutter speed and iris/gain
- The maximum number of times you can record on an SD card is 30.
- If a sharper focus cannot be achieved, adjust the focus manually. (→ 60)
- Noise increases in dark locations. Color balance and brightness on the screen may change with some light sources such as fluorescent lamps.
- Still picture quality can be changed. (→ 43)

- Image quality is different from ordinary still picture recording. To record more vivid still pictures, turn off this function before recording. (→ 41)
- If you turn off the power or set the mode switch to  , this function is canceled.

Built-in flash:

- Do not block the flash with your hand or by other means.
- Set the flash to [OFF] where using a flash is prohibited.
- Do not use the flash with the ND filter (optional) attached.
- The unit automatically determines if the flash is necessary even when it has been set to [OFF] by detecting the ambient brightness. (If it determines that the flash is necessary, the  indication lights up in red when the  button is pressed halfway.)
- If the  indication etc. flashes or is not displayed when the  button is pressed halfway, the flash is not activated.
- The available range of the flash is approx. 1 m to 2.5 m (3.3 feet to 8.2 feet) in dark places. Pictures will appear dark or reddish when they are recorded by using the flash at distances greater than 2.5 m (8.2 feet).
- Using the flash fixes a shutter speed to 1/500 or slower.
- The picture may appear dark if the flash is lit in front of a white background.
- A conversion lens (optional) can block the flash and may cause a vignetting effect.
- If the flash is activated a large number of times, it may take longer to charge it.

Red eye reduction:

- The flash is activated 2 times. Do not move until the second flash is finished.
- Red eye phenomenon may appear depending on the recording conditions.

Color bar:

- This function is canceled when the power is turned off.
- The icon will not be displayed.
- When the color bar is on, the menu settings of [GUIDE LINES], [24pDIGITAL CINEMA], [MIC LEVEL], [HI-SPEED BURST], [FLASH], [RED EYE], [ZEBRA], [MF ASSIST] and [Digital Cinema Color] cannot be selected.

Auto slow shutter:

- If the scene is low in brightness or contrast, the subject may not be focused in on.
- When the shutter speed becomes 1/30, the screen may be seen as if frames are missed and afterimages may appear.

Digital cinema color:

- To play back images recorded in the digital cinema color with vivid colors of wider color ranges, a device compatible with x.v.Color™ is required. When these images are played back with devices other than ones compatible with x.v.Color™, it is recommended to record the images after this function is turned [OFF].
- When motion pictures recorded while this function is turned [ON] are played back with a TV not compatible with x.v.Color™, colors may not be reproduced properly.
- x.v.Color™ is a name for devices that are compatible with the xvYCC format, an international standard for expanded color in motion pictures, and that follow the rules for signal transmission.

VIDEO PHOTO

◇ Operate the mode switch to select .

Set the AUTO/MANUAL/FOCUS switch to MANUAL.

The icon shown in the illustration appears.

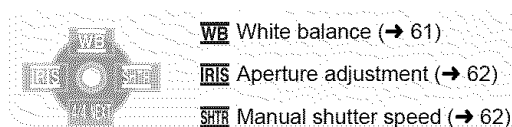
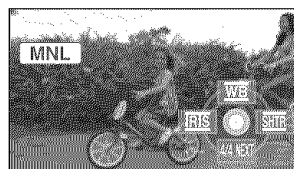
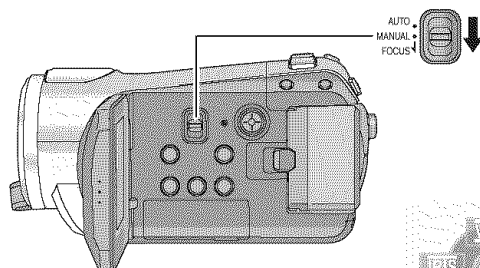

WB White balance (→ 61)

IRIS Aperture adjustment (→ 62)





SHTR Manual shutter speed (→ 62)

Scene mode

When you record images in different situations, this mode automatically sets optimum shutter speeds and apertures.

Select the menu. (→ 27)

[BASIC] → [SCENE MODE] → desired setting

Icon	Mode/Recording conditions
	Sports Used to record fast action.
	Portrait To make people stand out against the background
	Spotlight Improved quality when subject is brightly illuminated.
	Surf & snow Improved image quality when shooting on beaches or snowy locations.

- Set [SCENE MODE] to [OFF] or the AUTO/MANUAL/FOCUS switch to AUTO to cancel the function.

Sports mode

- For slow-motion playback or playback pause of recorded pictures, this mode helps diminish camera shake.
- During normal playback, the image movement may not look smooth.
- Avoid recording under fluorescent light, mercury light or sodium light because the color and brightness of the playback image may change.
- If you record a subject illuminated with bright light or a highly reflective subject, vertical lines of light may appear.
- If the brightness is insufficient, the sports mode does not function. The [] display flashes.
- If this mode is used indoors, the screen may flicker.

Portrait mode

- If this mode is used indoors, the screen may flicker. If so, change the scene mode setting to [OFF].

Spotlight mode

- If the recording subject is extremely bright, the subject may become washed out and the periphery extremely darkened.

Surf & snow mode

- If the subject is extremely bright, the recorded image may become washed out.

Manual focus adjustment

If auto focusing is difficult due to the conditions, then use manual focus.

- Set the AUTO/MANUAL/FOCUS switch to MANUAL. (→ 59)

1 (When MF assist function is used)

Select the menu. (→ 27)

[ADVANCED] → [MF ASSIST] → [ON]

- This function's default setting is [ON].

2 Move the switch down and set it to FOCUS position.

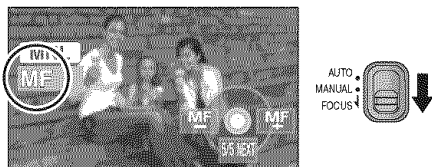

The manual focus indication [MF] and the icon shown in the illustration appear.

3 Move the cursor button to bring the subject into focus.



The center of the screen is enlarged. The normal screen returns approximately 2 seconds after you finish bringing the subject into focus.

- The center of the screen is not enlarged when [MF ASSIST] is [OFF].
- Move the AUTO/MANUAL/FOCUS switch down again to the FOCUS or AUTO position to restore to the automatic adjustment.

White balance

The automatic white balance function may not reproduce natural colors depending on the scenes or lighting conditions. If so, you can adjust the white balance manually.

- Set the AUTO/MANUAL/FOCUS switch to MANUAL. (→ 59)

1 Move the cursor button to select [WB].

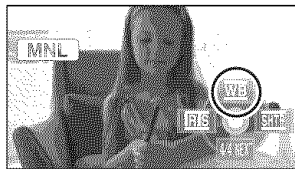

2 Select the white balance mode.



To set the white balance manually

- 1 Select [WB], fill the screen with a white subject.

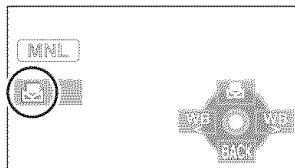

- 2 Select [WB].

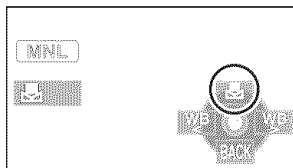

Icon	Mode/Recording conditions
	Auto white balance adjustment
	Indoor mode (for recording under incandescent lamps) Incandescent lights, halogen lamps
	Outdoor mode Outdoors under a clear sky
	Manual adjustment mode <ul style="list-style-type: none"> • Mercury-vapor lamps, sodium lamps, some fluorescent lights • Lights used for wedding receptions at hotels, stage spotlights in theaters • Sunrise, sunset, etc.

- Set the white balance mode to [AWB] or the AUTO/MANUAL/FOCUS switch to AUTO to restore to the automatic adjustment.

- When the screen turns black instantly and the [WB] display stops flashing and then lights constantly, the setting is complete.
- If the [WB] display continues flashing, the white balance cannot be set because it is too dark etc. In this case, use the automatic white balance.

- When the [WB] display flashes, the manual white balance previously adjusted is stored. Whenever recording conditions change, re-set the white balance for correct adjustment.
- When setting both the white balance and the iris/gain, set the white balance first.

Manual shutter speed/aperture adjustment

Shutter Speed:

Adjust it when recording fast-moving subjects.

Aperture:

Adjust it when the screen is too bright or too dark.

- Set the AUTO/MANUAL/FOCUS switch to **MANUAL**. (→ 59)

1 Move the cursor button to select [IRIS] (aperture) or [SHTR] (shutter speed).

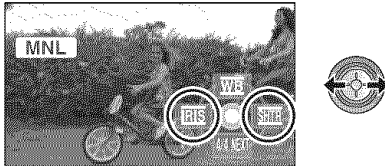

2 Make the adjustment.

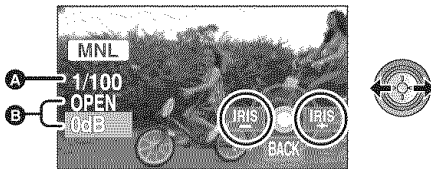

A Shutter speed:

1/30 to 1/8000

- If [AUTO SLOW SHTR] is set to [OFF], the shutter speed will be set between 1/60 and 1/8000.
- If [24pDIGITAL CINEMA] is set to [ON], the shutter speed will be set between 1/24 and 1/8000. (When [AUTO SLOW SHTR] is set to [OFF], the range is 1/48 to 1/8000.)
- The shutter speed closer to 1/8000 is faster.

B Iris/Gain value:

CLOSE → (F16 to F2.0) → OPEN → (0dB to 18dB)

- Value closer to [CLOSE] darkens the image.
- Value closer to [18dB] brightens the image.
- When the iris value is adjusted to brighter than [OPEN], it changes to the gain value.
- Set the AUTO/MANUAL/FOCUS switch to AUTO to restore to automatic adjustment.

- When setting both the shutter speed and the iris/gain value, set the shutter speed and then set the iris/gain value.

Manual shutter speed adjustment

- Avoid recording under fluorescent light, mercury light or sodium light because the color and brightness of the playback image may change.
- If you increase the shutter speed manually, the noise on the screen may increase.
- You may see vertical lines of light in the playback image of a brightly shining subject or highly reflective subject, but this is not a malfunction.
- During normal playback, image movement may not look smooth.
- When recording in an extremely bright place, the screen may change color or flicker. If so adjust the shutter speed manually to [1/60] or [1/100].

Manual iris/gain adjustment

- If the gain value is increased, the noise on the screen increases.
- Depending on the zoom magnification, there are iris values that are not displayed.

Preparation

Recording

Playback

Backup

With a PC

Others

64 Playback

72 Editing

78 With a TV

Motion picture playback

VIDEO

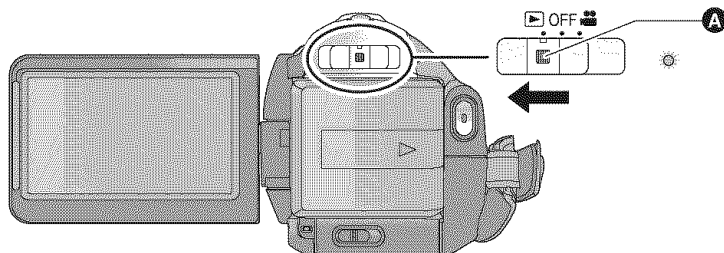

A Lock release button

- Operate the mode switch while at the same time pressing in the lock release button if changing from OFF to another mode.

1 Operate the mode switch to select .

2 Select [] (motion picture playback) with the cursor button.

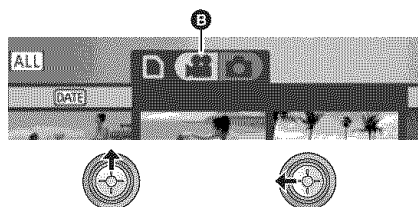

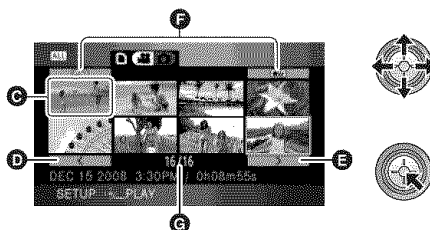

B Motion picture playback

3 Select the scene to be played back and press the cursor button.



- C Thumbnail display
- D Previous page
- E Next page
- F Play mode select button
- G Scene number

The selected scene is played back on the full screen, and the operation icon is automatically displayed on the screen.

- If 9 or more scenes have been recorded, the next (or previous) page can be displayed by moving the cursor button left and right or selecting  /  and then pressing the cursor button.
- The scene number display switches to the page number, except when thumbnails are selected.

- Press the cursor button while selecting the play mode select button to switch to the thumbnails of the following scenes.

[ALL] (All scenes):

Playback of all scenes

[DATE] (By date):

Playback of scenes recorded on a selected date (→ 67)

[★☆☆] (Intelligent scene selection):

Playback of the detected scenes that have been recorded vividly (→ 67)

4 Select the playback operation with the cursor button.

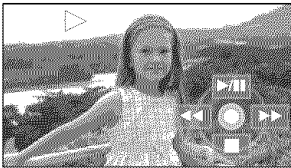

- ▶/||: Playback/Pause
 - ◀◀: Rewind playback
 - ▶▶: Fast forward playback
 - : Stops the playback and shows the thumbnails.
- The operation icon appears or disappears each time the cursor button is pressed.

■ Speaker volume adjustment

Move the volume lever to adjust the speaker volume during playback.

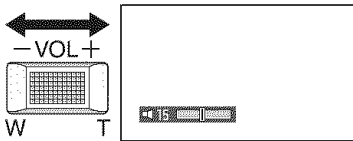

Towards “+”:

Increases the volume

Towards “-”:

Decreases the volume

■ Fast forward/rewind playback

Move the cursor button right during playback to fast forward.

(Move the cursor button left to rewind.)

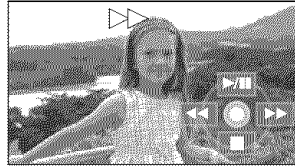

- The fast forward/rewind speed increases if you move the cursor button again. (The display on the screen changes from ▶▶ to ▶▶▶.)
- Normal playback is restored when you move the cursor button up.

Operating with the remote control

Press the ◀◀ or ▶▶ button during playback.

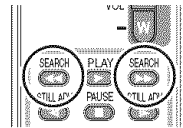

■ Skip playback (to the start of a scene)

(Operation is possible with the remote control only.)

Press the ◀◀ or ▶▶ button during playback.

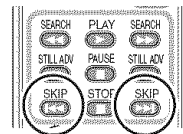

■ Slow-motion playback

- 1 Pause the playback.
- 2 Move and hold the cursor button right. (Move and hold the cursor button left to play back slow-motion pictures in reverse.)



- Normal playback is restored when you move the cursor button up.
- When slow-motion pictures are played back in reverse, they will be shown continuously at approximately 2/3rd the speed of normal playback (intervals of 0.5 seconds).

Operating with the remote control

Press the ◀ or ▶ button during playback.



■ Frame-by-frame playback

The motion picture is advanced one frame at a time.

- 1 Pause the playback.
- 2 Move the cursor button right. (Move the cursor button left to advance the frames one at a time in the reverse direction.)



- Normal playback is restored when you move the cursor button up.
- When the frames are advanced one at a time in the reverse direction, they will be shown in intervals of 0.5 seconds.

Operating with the remote control

- 1 Press the ||| button.

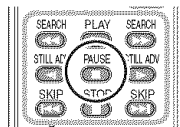

- 2 Press the ◀ or ▶ button.



Motion picture compatibility

- This unit is based on the AVCHD format.
- The video signal that can be played back on this unit is 1920×1080/60i, 1920×1080/24p or 1440×1080/60i.
- This unit may degrade or not play back motion pictures recorded or created on other products, and other products may degrade or not play back motion pictures recorded on this unit, even if the products support AVCHD.

- Sound will be heard only during normal playback.
- If pause play is continued for 5 minutes, the screen returns to the thumbnails.
- Any scenes where the thumbnails are displayed as [!] cannot be played back. An error message appears and the screen shows the thumbnails.
- During motion picture playback, the power will not turn off even if the LCD monitor is closed.
- The remaining time for playback indication will be reset to "0h00m00s" each scene.
- A continuous recording of motion picture data on the SD card that exceeds 4 GB may momentarily stop at every 4 GB of data when played back with another device.

Playing back motion pictures by date

Scenes recorded on the same day can be played back in succession.

- 1 Select **DATE** (By date), then press the cursor button.

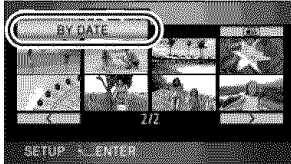

- 2 Select the playback date, then press the cursor button.



The scenes recorded on the date selected are displayed as thumbnails.

- Move the cursor button up or down to select the playback date. Move the cursor button left to select the last date of the previous month, and move it to the right to select the last date of the following month.

- 3 Select the scene to be played back, then press the cursor button.



- Select **ALL** (All scenes) and press the cursor button to return to the playback of all scenes.
- Playing back of all the scenes returns if the power is turned off or the mode switch is operated.

- Even if scenes are recorded on the same day, they are grouped separately in the following cases.
 - When the number of scenes exceeds 99
 - When the SD card is repaired
 - When the setting of 24pDIGITAL CINEMA is changed*
 - When the recording mode is changed from HA/HG/HX to HE* or HE to HA/HG/HX*
- * -1, -2... is added after the recording date displayed on the screen.

Intelligent scene selection (Extracting parts recorded clearly to play back)

Motion pictures are played back after excepting some parts that may not have been recorded clearly such as image shaking or out-of-focus scenes.

- 1 Select **Intelligent scene selection**, then press the cursor button.

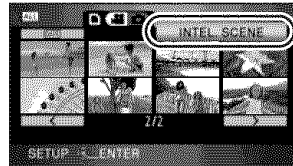

- 2 Select the scene to be played back, then press the cursor button.



- Select **ALL** (All scenes) and press the cursor button to return to the playback of all scenes.
- Select **DATE** (By date) and press the cursor button to activate the Intelligent scene selection on the selected date. (→ 67)
- To return to the Intelligent scene selection for all scenes, select **ALL** (All scenes) with the cursor button and then press the cursor button.

- The following motion pictures are skipped
 - When motion pictures are recorded while moving the unit quickly
 - When the unit shakes
 - When the image contrast is too strong such as when using backlight:
 - When scenes are too dark
 - When motion pictures are recorded while the unit is upside down or downward
 - When the subject is out of focus
- Up to 9 sections can be skipped for a single scene.
- When motion pictures are skipped, the image stops momentarily.
- The position of sections to be skipped may vary depending on the type of recording, with some having no skipped parts.
- Playing back all the scenes returns if the power is turned off or the mode switch is operated.
- For data that are copied to a PC or written to media by selecting motion pictures, or edited with the easy editing function of HD Writer 2.5E, the Intelligent scene selection is disabled.

Repeat playback

Playback of the first scene starts after playback of the last scene finishes.

Select the menu. (→ 27)

[VIDEO SETUP] → [REPEAT PLAY] → [ON]

The [] indication appears on the thumbnail and full screen views.

- All the scenes on the SD card are played back repeatedly. (When the play mode is set to [DATE], all the scenes on the selected date are played back repeatedly.)
- Set [REPEAT PLAY] to [OFF] to cancel the repeat playback function.

Resuming the previous playback

If playback of a scene was stopped halfway, the playback can be resumed from where it was stopped.

Select the menu. (→ 27)

[VIDEO SETUP] → [RESUME PLAY] → [ON]

If playback of a motion picture is stopped, [] appears on the thumbnail view of the stopped scene.

- Set [RESUME PLAY] to [OFF] to cancel the resume playback function.
- The memorized resume position is cleared if you turn off the power or operate the mode switch.

Still picture playback

PHOTO

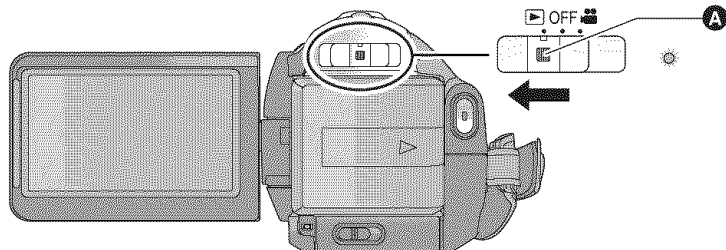

A Lock release button

- Operate the mode switch while at the same time pressing in the lock release button if changing from OFF to another mode.

1 Operate the mode switch to select .

2 Select [] (still picture playback) with the cursor button.

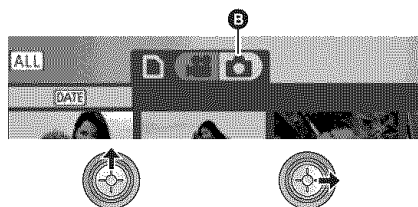

B Still picture playback

3 Select the still picture to be played back and press the cursor button.



- C** Play mode select button
- D** Thumbnail display
- E** Previous page
- F** Next page
- G** Still picture number
- H** Folder/file name

The selected still picture is played back on the full screen, and the operation icon is automatically displayed on the screen.

- If 9 or more still pictures have been recorded, the next (or previous) page can be displayed by moving the cursor button left and right or selecting / and then pressing the cursor button.
- The picture number display switches to the page number, except when thumbnails are selected.

- Select the play mode select button and press the cursor button to switch the following picture displays to thumbnail view.

ALL (All scenes):

Playback of all still pictures

DATE (By date):

Playback of still pictures recorded on a selected date (→ 71)

4 Select the playback operation with the cursor button.



▶/||: Slide show (playback of the still pictures in numerical order) start/pause.

◀||: Plays back the previous picture.

||▶: Plays back the next picture.

■: Stops the playback and shows the thumbnails.

- The operation icon appears or disappears each time the center of the cursor button is pressed.

Still picture compatibility

- This unit is compliant with the unified standard DCF (Design rule for Camera File system) established by JEITA (Japan Electronics and Information Technology Industries Association).
- The file format of still pictures supported by this unit is JPEG. (Not all JPEG formatted files will be played back.)
- If a non-standard still picture is played back, the folder/file name may not be displayed.
- This unit may degrade or not play back still pictures recorded or created on other products and other products may degrade or not play back still pictures recorded on this unit.

- Any still pictures where the thumbnails are displayed as **!** cannot be played back. An error message appears and the screen shows the thumbnails.
- During still picture playback, the power will not turn off even if the LCD monitor is closed.

Playing back still pictures by date

Still pictures recorded on the same day can be played back in succession.

1 Select **DATE** (By date), then press the cursor button.



2 Select the playback date, then press the cursor button.

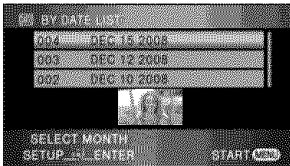

The still pictures recorded on the date selected are displayed as thumbnails.

- Move the cursor button up or down to select the playback date. Move the cursor button left to select the last date of the previous month, and move it to the right to select the last date of the following month.

3 Select the still picture to be played back.



- Select **ALL** (All scenes) and press the cursor button to return to the playback of all still pictures.
- Playing back of all the still pictures returns if the power is turned off or the mode switch is operated.

- Even if still pictures are recorded on the same day, they are grouped separately in the following cases.
 - When the number of still pictures exceeds 999
 - When pictures are recorded in HD hi-speed burst shooting mode ([]) is indicated before the date in the list by date).

Deleting scenes/still pictures

VIDEO PHOTO

Important:

The deleted scenes/still pictures cannot be restored.

◇ Operate the mode switch to select .

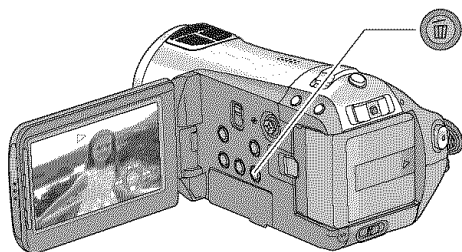

To delete by confirming images being played back

Press the  button while scenes or still pictures to be deleted are being played back.

- When the confirmation message appears, select [YES], then press the cursor button.

■ Deleting multiple scenes/still pictures from the thumbnail display

1 Press the  button while the thumbnail view screen is displayed.

2 Move the cursor button to select [SELECT] or [ALL SCENES] and press the cursor button.



- When [ALL SCENES] is selected, the following scenes/still pictures except the protected scenes/still pictures on the SD card will be deleted. When the confirmation message appears, select [YES], then press the cursor button.

- When the play mode is set to **[ALL]**:
All scenes or still pictures
- When the play mode is set to **[DATE]**:
All the scenes or still pictures on the selected date

3 (Only when [SELECT] is selected in step 2) **Select the scene/still picture to be deleted, then press the cursor button.**



- To unselect the scene/still picture, press the cursor button again.
- Up to 99 scenes can be selected to be deleted.

4 (Only when [SELECT] is selected in step 2) **Press the  button.**

- When the confirmation message appears, select [YES], then press the cursor button.

(Only when [SELECT] is selected in step 2)
To continue deleting other scenes
Repeat steps 3-4.



To complete editing

Press the MENU button.

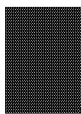
-
- You can also delete scenes by pressing the MENU button, selecting [EDIT SCENE] → [DELETE] → [ALL SCENES] or [SELECT].
 - You can also delete still pictures by pressing the MENU button, selecting [PICT. SETUP] → [DELETE] → [ALL SCENES] or [SELECT].
 - When play mode is set to [INTEL. SCENE], scenes cannot be deleted.
 - To delete an unwanted part of a scene, divide the scene first, and then delete the unnecessary part. (→ 74)
 - Scenes/still pictures which cannot be played back (the thumbnails are displayed as ) cannot be deleted.
 - Do not open the SD card cover while deleting motion pictures or still pictures on the SD card. The deletion will stop.
 - In case of [ALL SCENES], the deletion may take time if there are many scenes or still pictures on the SD card.
 - Do not turn off this unit while deleting.
 - When you delete scenes/still pictures, use a battery with sufficient battery power or use the AC adaptor.
 - If you delete scenes recorded on other products or still pictures conforming to DCF standard with this unit, all the data related to the scenes/still pictures may be deleted.
 - When still pictures recorded on an SD card by other products are deleted, a still picture (other than JPEG) that cannot be played back on this unit may be erased.



To delete an unnecessary portion of a scene, first divide the scene and then delete the unnecessary portion.

◇ Select [] (motion picture playback) while the mode switch is set to  . (→ 64)

1 Select the menu. (→ 27)

[EDIT SCENE] → [DIVIDE] → [SET]

2 Select the scene to be divided, then press the cursor button.



3 Select [] to set the dividing point.



- Using slow-motion playback or frame-by-frame playback makes it easy to search for the point where you want to divide the scene. (→ 66)
- When the confirmation message appears, select [YES], then press the cursor button.

4 Press the MENU button to complete dividing.

5 Delete the unnecessary scene. (→ 72)

To continue dividing other scenes

Repeat steps 2-3 before completing dividing in step 4.

To delete all the divided points

[DIVIDE] → [CANCEL ALL]

- When the confirmation message appears, select [YES], then press the cursor button.
 - All divided points set on this unit will be canceled.
 - The scenes that were deleted after division cannot be recovered.
-
- When play mode is set to [INTEL. SCENE], scenes cannot be divided.
 - Scenes cannot be divided if the number of all scenes has reached 3998 or the number of scenes played back on a selected date has reached 99.
 - It may not be possible to divide scenes with a short recording time.
 - If images that have been divided are played back on another device, the points where the scenes join may not be clear.
 - Data that has been recorded or edited on another device cannot be divided and the divided points cannot be deleted.
 - When [CANCEL ALL] is selected, the divided points of all scenes are deleted and the unit turns back to the setting that plays back all scenes even if you selected to play back the scenes by date.

Protecting scenes/still pictures

VIDEO PHOTO

Scenes/still pictures can be protected so that they are not deleted by mistake. (Even if you protect some scenes/still pictures on an SD card, formatting the SD card will delete them.)

◇ Operate the mode switch to select  .

1 Select the menu. (→ 27)

[VIDEO SETUP] or [PICT. SETUP] →
[SCENE PROTECT] → [YES]

2 Select the scene/still picture to be protected and then press the cursor button.



The [On] indication appears and the scene/still picture is protected.

- Press the cursor button again to cancel the setting.
 - 2 or more scenes/still pictures can be set in succession.
 - Press the MENU button to complete the settings.
-
- When play mode is set to [INTEL. SCENE] while playing back motion pictures, scenes cannot be protected.

PHOTO

You can write the data selecting still pictures to be printed and the number of prints (DPOF data) onto the SD card.

◇ Select [] (still picture playback) while the mode switch is set to  . (→ 69)

■ What is DPOF?

DPOF (Digital Print Order Format) is a format which allows the user of a digital camera to define which captured images on the SD card are to be printed, together with information on the number of copies they wish to print. (Please note: Not all commercial printing services support this feature at his time.)

1 Select the menu. (→ 27)

[PICT. SETUP] → [DPOF SET] → [SET]

To cancel all DPOF settings

Select the menu. (→ 27)

[DPOF SET] → [CANCEL ALL]

- When the confirmation message appears, select [YES], then press the cursor button.
- Please perform the DPOF settings on this unit.
- You cannot add the recording date to pictures to be printed with the DPOF settings.

2 Select the still picture to be set, then press the cursor button.



3 Select the number of prints, then press the cursor button.



- To cancel the setting, set the number of prints to [0].
- You can also select multiple still pictures in succession.
- Press the MENU button to complete the settings.

VIDEO PHOTO

Please be aware that if an SD card is formatted, then all the data recorded on the card will be erased. Back up important data on a PC, DVD disc etc.

1 Select the menu. (→ 27)

[SETUP] → [FORMAT CARD] → [YES]

- When the confirmation message appears, select [YES], then press the cursor button.
- When formatting is complete, press the MENU button to exit the message screen.

-
- Do not turn this unit off or remove the SD card, while formatting. Do not expose the unit to vibrations or shock.

Use this unit to format SD cards.

Do not format an SD card using any other equipment such as a PC. The card may not be used on this unit.

Watching Video/Pictures on your TV

VIDEO PHOTO

The motion pictures and still pictures recorded on this unit can be played back on a TV screen.

Confirm the terminals on your TV and use a cable compatible with the terminals. Image quality may vary with the connected terminals.

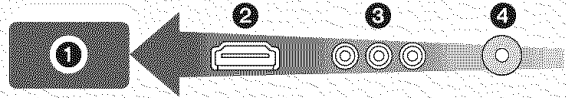

- 1 High quality
- 2 HDMI terminal
- 3 Component terminal
- 4 Video terminal

- Use the AC adaptor to free you from worrying about the battery running down.
- Use the supplied component cable to connect the unit via the component terminal on your TV, while using the supplied AV cable to connect it to the video terminal. Use of the following Panasonic HDMI mini cables is recommended to connect the unit to the HDMI terminal.

1 Connect this unit to a TV.

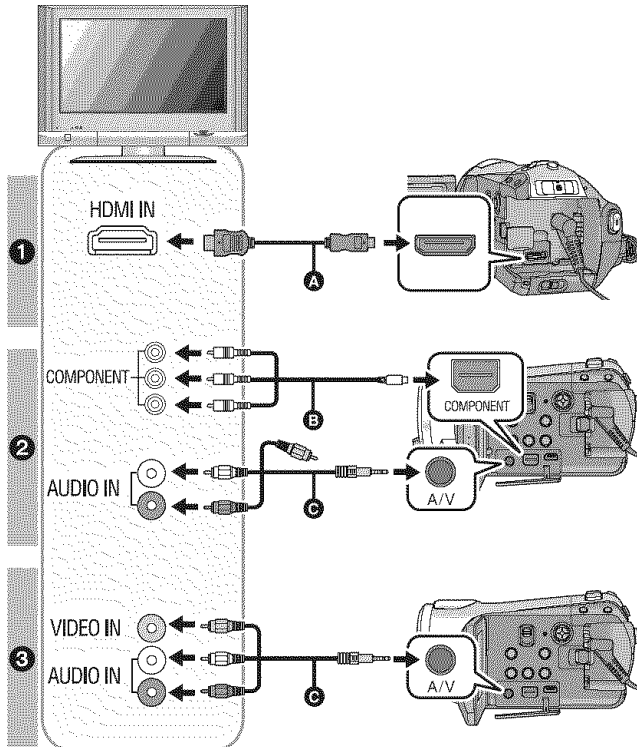

- A HDMI mini cable (optional)
- B Component cable (supplied)
- C AV cable (supplied)

Picture quality

- 1 High definition images when connecting to HDMI terminal
- 2 High definition images when connecting to component terminal compatible with 1080i
Standard images when connecting to component terminal compatible with 480i
- 3 Standard images when connecting to video terminal

- Check that the plugs are inserted as far as they go.
- We recommend using Panasonic HDMI mini cables (optional).
Part numbers: RP-CDHM15 (1.5 m/4.9 feet), RP-CDHM30 (3.0 m/9.8 feet)
- Do not use any other component cables except the supplied one.
- The component terminal is for outputting images only so be sure to also connect the AV cable. (It is not necessary to connect the yellow plug.)
- Do not use any other AV cables except the supplied one.

2 Select the video input on the TV, that this unit is connected to.

- Example:

Select the [HDMI] channel with a HDMI mini cable.

Select the [Component] channel with a component cable.

Select the [Video 2] channel with an AV cable.

(The name of the channel may differ depending on the connected TV.)

3 Set the mode switch to to play back.

- The image and audio are output on the TV.

Cables	Reference items
A HDMI mini cable (optional)	<ul style="list-style-type: none"> • Connecting with a HDMI mini cable (→ 81) • Listening in 5.1 channel sound (→ 82) • Playback using VIERA Link™ (HDAVI Control™) (→ 83)
B Component cable (supplied)	<ul style="list-style-type: none"> • Connecting with the component cable (→ 82)

If the image or audio from this unit does not appear on the TV

- Check the connections.
- Check that the plugs are inserted as far as they go.
- **Check the input setting (input switch) and the audio input setting on the TV. (For more information, please read the operating instructions for the TV.)**
- **Check [HDMI RESOLUTION] when connecting with a HDMI mini cable. (→ 81)**

■ To watch images with a 16:9 aspect ratio on a regular TV (4:3)

When playing back motion pictures or still pictures recorded on this unit with a 16:9 aspect ratio on a TV with a 4:3 aspect ratio, the images on the screen may be squeezed horizontally. In this case, change the menu setting to play back the pictures in the original aspect ratio. (Depending on the TV setting, the pictures may not be displayed correctly. For more information, please read the operating instructions of your TV.)

Select the menu. (→ 27)

[SETUP] → [TV ASPECT] → [4:3]

Example of images with a 16:9 aspect ratio on a regular TV (4:3)

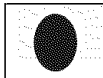
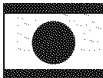
[TV ASPECT] setting	
[16:9]	[4:3]
	

- If a wide-screen TV is connected, adjust the aspect setting on the TV. (Refer to the operating instructions of the TV for details.)

■ To display the on-screen information on the TV

When the EXT DISPLAY button on the remote control is pressed, the information displayed on the screen (operation icon and time code etc.) can be displayed on the TV.

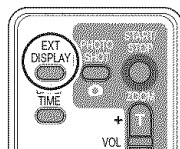

- Press the button again to erase the information.
 - The screen on this unit will not change.
-
- When connecting with a HDMI mini cable, be sure to connect to a HDMI input terminal. Do not connect to a HDMI output terminal on other products.
 - When connecting with a component cable, be sure to also connect the AV cable. (Insert it in the audio input terminal for the component terminal input.)
 - When a HDMI mini cable and the AV cable are connected at the same time, priority is given to the output from the HDMI mini cable.
 - When the component cable and the AV cable are connected at the same time, priority is given to the component cable for image output.

Refer to the following support site for information about the Panasonic TVs that you can directly insert an SD card into the SD card slot on the TV and then play it back.

<http://panasonic.net/>

- For details on how to play back, please read the operating instructions for the TV.

Connecting with a HDMI mini cable

What is HDMI?

HDMI is the next-generation interface for digital devices. When this unit is connected to a HDMI compatible device, the image and audio can be output with a digital signal. If you connect this unit to a HDMI compatible high definition TV and then play back the recorded high definition images, you can enjoy them in high resolution with high quality sound.

If you connect this unit to a Panasonic TV compatible with VIERA Link, linked operations (VIERA Link) are possible. (→ 83)

Select the desired method of HDMI output when using an HDMI mini cable (optional).

Select the menu. (→ 27)

[SETUP] → [HDMI RESOLUTION] → **desired setting**

[AUTO]: The output resolution is automatically set based on the information from the connected TV.

Information from the connected TV	Output resolution
720p, 1080i	1080i
Others	480p

[1080i]: The interlace method with 1080 available scan lines is used for output.

[480p]: The progressive method with 480 available scan lines is used for output.

1080i

This is an interlace scan method which scans 1080 scan lines to display a high definition image. The 1080 available scan lines are divided in half and scanned on the screen alternatively every 1/60th of a second. The number of available scan lines is more than double the 480 scan lines used to display standard images until now so the images have clearer detail and a lot of presence.

480p

This is a progressive scan method which scans all 480 available scan lines on the screen at the same time every 1/60th of a second. This method reduces the flickering as the scan lines are not scanned on the screen alternatively like in the interlace method.

480i

This is an interlace scan method in which the 480 available scan lines are divided in half and scanned on the screen alternatively every 1/60th of a second.

Interlace method/progressive method

Video signals until now (NTSC) are referred to as 480i (i is short for interlace) whereas a high-density video signal that doubles the number of scan lines is called 480p (p is short for progressive). The component terminal and the HDMI mini connector on this unit are also compatible with high definition image output 1080i. It is necessary to have a compatible TV to enjoy progressive and high definition images.

- If the images are not output on the TV when the setting is [AUTO], switch to the method [1080i] or [480p] which enables the images to be displayed on your TV. (Please read the operating instructions for the TV.)

Listening in 5.1 channel sound

If you connect this unit and an AV amplifier with a HDMI terminal with a HDMI mini cable and then playback, you can listen to 5.1 channel sound recorded from the internal microphones.

- Please read the operating instructions for the AV amplifier, speakers and TV for more information about how to connect them etc.
- If you connect this unit to a Panasonic AV amplifier and Panasonic TV that are compatible with VIERA Link, linked operations (VIERA Link) become possible. (→ 83)
- The unit cannot be connected to the optical digital cable. Connect it to an AV amplifier with the HDMI terminals.

Connecting with the component cable

When this unit is connected to a TV with the component cable, the output setting on this unit can be changed. Set it to match the terminal on the TV that you connect to.

Select the menu. (→ 27)

[SETUP] → [COMPONENT OUT] → **desired setting**

[480i]: When connecting to the component terminal on the TV compatible with 480i.
(Playback is in standard quality.)

[1080i]: When connecting to the component terminal on the TV compatible with 1080i.
(Playback is in high definition quality.)

Playback using VIERA Link™ (HDAVI Control™)

VIDEO PHOTO

What is the VIERA Link?

- VIERA Link™ is a new name for EZ Sync™.
- This function allows you to use your remote control for the Panasonic TV for easy operations when this unit has been connected to an VIERA Link compatible device using a HDMI mini cable (optional) for automatic linked operations. (Not all operations are possible.)
- VIERA Link is a unique Panasonic function built on a HDMI control function using the standard HDMI CEC (Consumer Electronics Control) specification. Linked operations with HDMI CEC compatible devices made by other companies are not guaranteed. When using devices made by other companies that are compatible with VIERA Link, refer to the operating instructions for the respective devices.
- This unit is compatible with VIERA Link Ver.3. VIERA Link Ver.3 is the newest Panasonic version and is also compatible with existing Panasonic VIERA Link devices. (As of December 2007)

Connect this unit to a Panasonic TV compatible with VIERA Link with a HDMI mini cable and then operate with the remote control for the TV.

■ Setting on this unit

◇ Set the mode switch to  .

Select the menu. (→ 27)

[SETUP] → [VIERA Link] → [ON]

- The default setting is [ON].

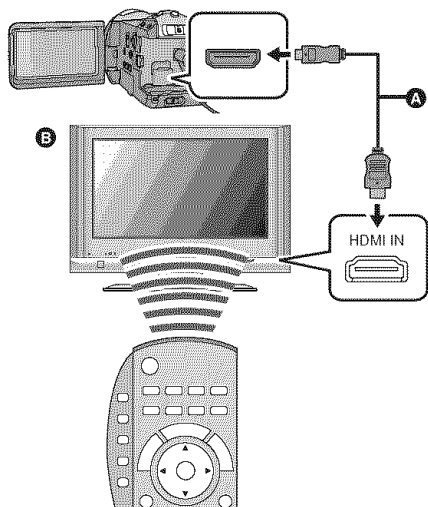

- A** HDMI mini cable (optional)
- B** Panasonic TV compatible with VIERA Link

■ Playback operation with the remote control for the TV

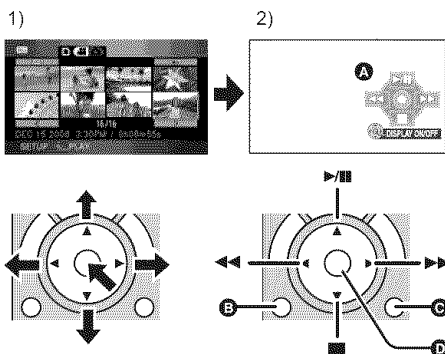

- 1) Press the button up, down, left or right to select a scene or file to be played back, and then press the button in the center to set it.
- 2) Activate the operation icons that are displayed on TV screen with the remote control for the TV.

- A** Operation icons
- B** Display operation icons
- C** Cancel operation icons
- D** Display/Cancel operation icons
- The playback operation is performed the same as on this unit.
 - Playing back motion pictures (→ 64)
 - Playing back still pictures (→ 69)

- If the TV has two or more HDMI input terminals, it is recommended to connect this unit to HDMI2 or HDMI3.
- VIERA Link must be activated on the connected TV. (Read the operating instructions of the TV for how to set etc.)
- If you are not using VIERA Link, set [VIERA Link] to [OFF].

■ Other linked operations

Turning the power off:

If you use the remote control for the TV to turn off the power, the power on this unit also turns off. (When recording motion pictures, formatting, deleting, recovering or connecting the unit to a PC with a USB cable, the power will not turn off.)

Automatic input switching:

If you connect with a HDMI mini cable and then turn on the power on this unit, the input channel on the TV automatically switches to this unit's screen. If the TV's power is in standby status, it will turn on automatically (if [Set] has been selected for the TV's [Power on link] setting).

- Depending on the HDMI terminal on the TV, the input channel may not switch automatically. In this case, use the remote control for the TV to switch the input channel. (For details on how to switch input, please read the operating instructions for the TV.)
- If VIERA Link does not work properly, refer to page 119.

-
- If you are unsure whether or not the TV and AV amplifier you are using are compatible with VIERA Link, read the operating instructions for the devices.
 - Available linked operations between this unit and a Panasonic TV is different depending on the types of Panasonic TVs even if they are compatible with VIERA Link. Refer to the operating instructions of the TV for the operations that support on the TV.
 - Operation is not possible with a cable that is not based on the HDMI standard.
We recommend using Panasonic HDMI mini cables.
Part numbers: RP-CDHM15 (1.5 m/4.9 feet), RP-CDHM30 (3.0 m/9.8 feet)

Preparation

Recording

Playback

Backup

With a PC

Others

86 With other products

Connecting a DVD burner to copy to/play back a disc

VIDEO PHOTO

Motion pictures or still pictures recorded with this unit can be copied to a DVD disc by connecting a DVD burner VW-BN1 (optional) to this unit using a Mini AB USB connection cable (supplied with VW-BN1). The copied DVD disc can also be played back.

- Please read the operating instructions of the DVD burner for how to use it.

Preparing for copying/playing back

We recommend using Panasonic DVD burner VW-BN1.

About discs that can be used for copying

New* 12 cm discs (DVD-RAM, DVD-RW, DVD-R, DVD-R DL)

- You cannot copy to 8 cm discs or +RW/+R/+R DL/CD-RW/CD-R.

- We recommend using the discs that have been recommended in the operating instructions of the DVD burner. Refer to the operating instructions of the DVD burner for details about recommended discs, disc handling etc.

* You cannot record on a disc that has already been used. However if a DVD-RAM or a DVD-RW is formatted, then it can be used for copying.

1 Connect the AC adaptor (supplied with VW-BN1) to the DVD burner.

- You cannot supply power to the DVD burner from this unit.

2 Connect this unit to the AC adaptor and set the mode switch to .

- If a battery is used, operation is not possible when this unit is connected to a DVD burner.

3 Connect this unit to the DVD burner with the Mini AB USB connection cable (supplied with VW-BN1).

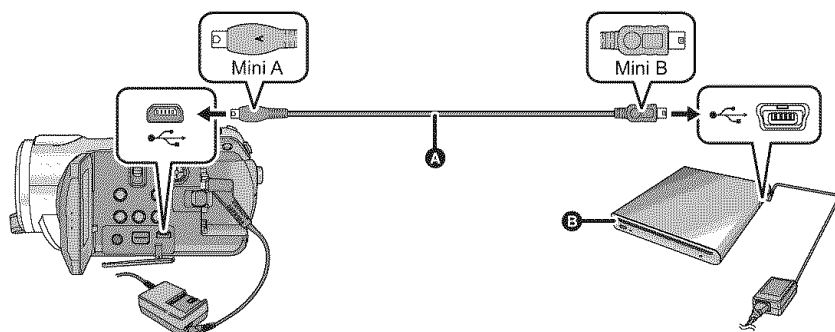

A Mini AB USB Connection Cable (supplied with VW-BN1)

B DVD burner (optional)

- Insert the plugs as far as they will go.

4 Insert the disc in the DVD burner.

5 (When copying)

Select **[BURN DISC]** and press the cursor button.

(When playing back)

Select **[PLAY DISC]** and press the cursor button.

- Refer to page 90 for how to play back the copied discs.

Copying to discs

- Motion pictures are copied as AVCHD format high definition images.
- We recommend preparing the necessary number of discs that can be used for copying (→ 86), and spare discs.
- You cannot copy from multiple SD cards to 1 disc.
- Motion pictures and still pictures cannot both be copied to a single disc.
- Confirm that auto protection is [ON] before copying data. We recommend that auto protection is turned [ON] while copying data. (→ 91)

1 Connect this unit to the DVD burner to prepare for copying. (→ 86)

2 Select the item and press the cursor button.

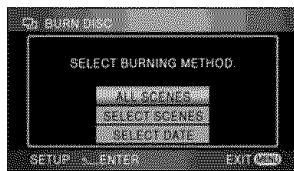

[ALL SCENES]:

This is for copying all scenes simultaneously. (Since motion pictures and still pictures are copied to separate discs, two or more discs are required.) Proceed to step 6.

[SELECT SCENES]:

This is for selecting the scenes to copy.

[SELECT DATE]:

This is for selecting date of the scenes to copy.

3 (Only when [SELECT SCENES]/ [SELECT DATE] is selected in step 2) Select **[VIDEO]** or **[PICTURE]** and press the cursor button.



4 (Only when [SELECT SCENES] is selected in step 2)

Select the scene you want to copy and press the cursor button.



- When the cursor button is pressed again, the selected scene will be canceled.
- Up to 99 scenes can be selected in succession.

(Only when [SELECT DATE] is selected in step 2)

Select the date you want to copy and press the cursor button.

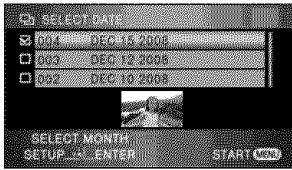

- When the cursor button is pressed again, the selected date will be canceled.
- Up to 99 dates can be selected in succession.
- Move the cursor button up or down to select the playback date. Move the cursor button left to select the last date of the previous month, and move it to the right to select the last date of the following month.

5 (Only when [SELECT SCENES] is selected in step 2)

Select [START] and press the cursor button.



(Only when [SELECT DATE] is selected in step 2)

Press the MENU button.



6 When the confirmation message appears, select [YES], then press the cursor button.

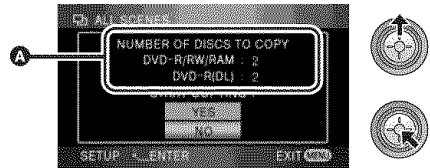

- A** The number of discs necessary for copying by disc type
- When 2 or more discs are necessary for copying, follow the on-screen instructions to switch discs.
 - After copying is complete, eject the disc and disconnect the Mini AB USB Connection Cable from this unit.
 - After copying is complete, the disc becomes play-only and further recording is no longer possible.

Before you delete the data on the SD card after copying is complete, be sure to play back the discs to check that they have been copied to correctly. (→ 90)

Important Notice

- When connecting an optional DVD burner and this unit for copying a disc, do not insert a disc with recorded motion pictures into devices that do not support the AVCHD format. In some cases the disc may get stuck in the device. The disc will not play back on devices that do not support the AVCHD format.
- When inserting a disc containing recorded motion/still pictures into other devices, a message prompting you to format the disc may be displayed. Do not format the disc, since deleted data cannot be restored later.

About the approximate time it takes for copying to a disc

To copy motion pictures to the full capacity of a disc

Disc type	Copy time
DVD-RAM	Approx. 50 min to 80 min
DVD-RW*	Approx. 35 min to 75 min
DVD-R*	Approx. 25 min to 45 min

* The data is written to all areas of the disc to increase playback compatibility with other devices so, even if the data capacity to be copied is small, the time it takes for copying may be about the same as the time shown in the table.

To copy 600 still pictures (approx. 600 MB)

Disc type	Copy time
DVD-RAM/DVD-RW/DVD-R	Approx. 30 min to 40 min

- DVD-R DL have two layers of recording surface so the copy time is approximately 2 to 3 times that of DVD-R.
- Depending on the following conditions, the time it takes for copying may be longer than the above times. Wait until a message appears indicating that copying is complete.
 - The number of recorded scenes:
It will take time to copy if the number of recorded scenes is large even when the recording time is the same.
 - When the temperature of the DVD burner has become high:
Example: If multiple discs have been copied to continuously or the surrounding temperature is high.

■ To copy the same data on a new disc successively after confirming the contents of the copied disc by playing it back

Press the DISC COPY button on the playback thumbnail view to display the selection screen in Step 2, so that you can copy data again.

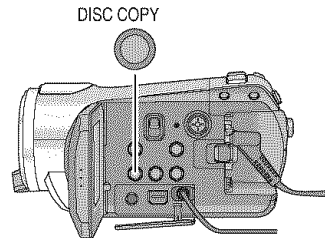

- The disc that was copied to can be played back by connecting this unit and a DVD burner. (→ 90)
- Do not turn off this unit or the DVD burner or disconnect the Mini AB USB Connection Cable while copying. Also, do not shake the DVD burner.
- It is impossible to stop copying halfway.
- The order in which the scenes were copied cannot be changed.
- Data that has been recorded on another device may not be copied.
- Motion pictures that are recorded on a PC with HD Writer 2.5E cannot be copied.
- When 2 or more discs are necessary for copying, the last scene copied to a disc is automatically divided to fit the space on the disc.
- The number of discs necessary for copying is automatically calculated. However, copying may be completed using less discs than the number displayed if there is other data on the SD card or if scenes were automatically divided.
- When the disc that was copied to is played back on another device, the picture may momentarily stop at the points where the scenes switch.

Playing back the copied disc

- Only discs that have been copied by connecting this unit to the DVD burner or where motion pictures have been recorded in AVCHD format can be played back. It may not be possible to play back discs recorded on other devices.

1 Connect this unit to the DVD burner to prepare for playback. (→ 86)

2 Use the cursor button to select [] disc playback tab.

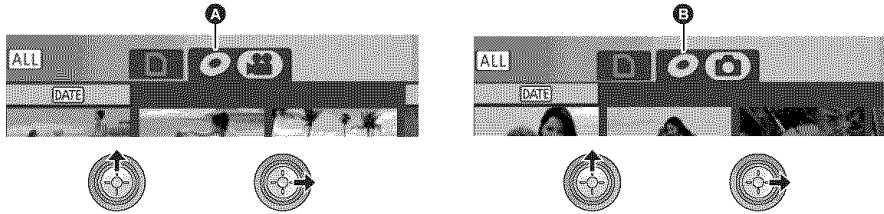

- A** (Destination disc for motion pictures)
Disc playback tab
- B** (Destination disc for still pictures)
Disc playback tab

3 Select the scene or still picture to be played back and then play it back.

- The playback operation is performed the same as when playing back motion pictures or still pictures. (→ 64, 69)
 - After playback, eject the disc and disconnect the Mini AB USB Connection Cable from this unit.
-
- Press the DISC COPY button in thumbnail view to display the selection screen for copying data to a disc. The data can be copied to a new disc inserted in the DVD burner. (→ 89)

Managing the copied disc (Formatting/Auto protect/Displaying disc information)

- Connect this unit to the DVD burner and then select [PLAY DISC]. (→ 86)

■ Formatting discs

This is for initializing DVD-RAM and DVD-RW discs.

- Select [] tab.

Please be aware that if a disc is formatted, then all the data recorded on the disc will be erased. Back up important data on a PC etc.

Select the menu. (→ 27)



[DISC SETUP] or [SETUP] →
[FORMAT DISC] → [YES]

- When the confirmation message appears, select [YES], then press the cursor button.
- When formatting is complete, press the MENU button to exit the message screen.

- Connect this unit and the DVD burner to format discs. You may no longer be able to use the discs if you format them on another device such as a PC etc.

■ Auto protect

You can protect (write protect) a DVD-RAM or DVD-RW disc when copying to it so that it is not formatted by mistake when you insert it in another device.

- Select [] (motion picture playback) of [] tab.

1 Select the menu. (→ 27)

[DISC SETUP] → [AUTO PROTECT] → [ON]

- The default setting is [ON].
- We recommend setting [AUTO PROTECT] to [ON] in order to prevent accidental deletion on other devices.

If a disc that you copied to is inserted in another device without protecting it, a message may be displayed prompting you to format the disc. If the disc is formatted, important data will

be erased and the process cannot be reversed.

2 Copy to the disc. (→ 87)



- The copied disc is write protected when it is ejected if [AUTO PROTECT] is [ON].

To release the disc protection

- If you format a disc, the auto protection is released. Please be aware that if a disc is formatted, then all the data recorded on the disc is erased and cannot be recovered.
- The disc will need to be re-formatted on the device you will use.

■ Displaying disc information

Information such as the type of recorded disc, the number of recorded scenes and whether or not the disc is finalized is displayed.

- Select [] (motion picture playback) of [] tab.

Select the menu. (→ 27)

[DISC SETUP] → [INFORMATION] → [YES]

- Press the MENU button to exit the information screen.

Dubbing images onto other video device

VIDEO

Images played back on this unit can be dubbed onto a DVD recorder or video device.

- Images are dubbed in standard quality.
- Use the AC adaptor to free you from worrying about the battery running down.

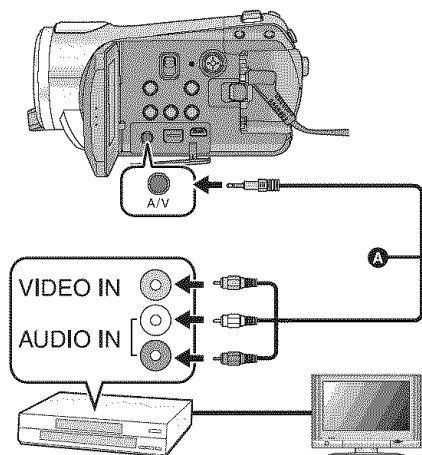

Change the video input on the video device and TV that this unit is connected to.

- The channel set will differ depending on the terminal to which the unit is connected.
 - See the operating instructions of the video device for details.
 - Insert the plugs as far as they will go.
 - Do not use any other AV cables except the supplied one.
- A** AV cable (supplied)

1 Connect this unit to a video device and then set the mode switch to .

2 Start playback on this unit.

3 Start recording on the connected device.

- To stop recording (dubbing), stop playback on this unit after stopping recording on the recorder.
- If the date and time display and function indication are not wanted, cancel them before dubbing. (→ 30, 80)

If the dubbed images are played back on a wide-screen TV, the images may be stretched vertically. In this case, refer to the operating instruction of the device you are connecting to or read the operating instructions of the wide-screen TV and set the aspect ratio to 16:9.

PHOTO

To print pictures by directly connecting this unit to the printer, use a printer compatible with PictBridge. (Read the operating instructions for the printer.)

PictBridge is an industry standard from the Camera & Imaging Products Association (CIPA) for direct printing. It allows images to be printed directly from digital cameras to a printer, without having to connect the camera to a PC.

- Use the AC adaptor to free you from worrying about the battery running down.
- Turn on this unit. (This function is available in all modes.)

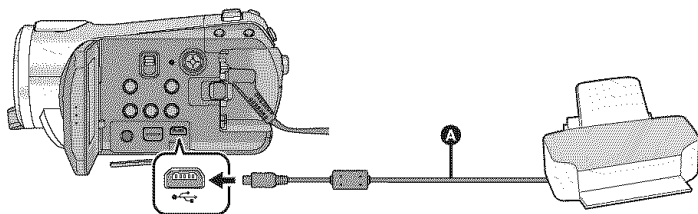

- A** USB cable (supplied)
- Insert the plugs as far as they will go.

1 Connect this unit to a printer.

- Do not use any other USB connection cables except the supplied one. (Operation is not guaranteed with any other USB cables.)

2 Select [PictBridge] and press the cursor button.

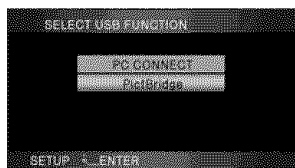

- If the [PictBridge] indication does not appear or continues to flash, disconnect and then reconnect the USB cable.

3 Select a still picture to be printed, then press the cursor button.



4 Select the desired number of prints, then press the cursor button.



- You can set up to 9 prints.
- To cancel the setting, set the number of prints to [0].
- Up to 8 files can be set in succession by repeating steps 3 and 4.

5 Press the MENU button to display the PictBridge menus.



6 Select the date print setting on [DATE PRINT].

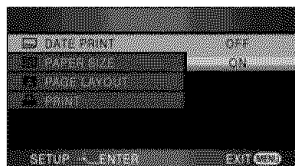

- If the printer is not capable of date printing, this setting is unavailable.

7 Select the paper size setting on [PAPER SIZE].



[STANDARD]: Size specific to the printer

[4×5 INCH]: L size

[5×7 INCH]: 2L size

[4×6 INCH]: Postcard size

[A4]: A4 size

- You cannot set paper sizes not supported on the printer.

8 Select the desired layout setting on [PAGE LAYOUT].

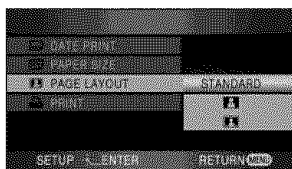

[STANDARD]: Layout specific to the printer

[]: No frame print

[]: Frame print

- You cannot set page layouts not supported on the printer.

9 Select [PRINT] → [YES] and press the cursor button to print the pictures.



- Exit PictBridge by disconnecting the USB cable (supplied) after the pictures have been printed.

When you stop printing halfway

Move the cursor button down.

- A confirmation message appears. If [YES] is selected, the number of prints set is canceled and the screen returns to step 3. If [NO] is selected, all the settings are kept and the screen returns to step 3.

- Avoid the following operations during printing. These operations disable proper printing.

- Disconnecting the USB cable
- Opening the SD card cover and removing the SD card
- Switching the mode switch
- Turn the unit off

- Check the settings for the paper size, print quality etc. on the printer.
- The print quality varies with paper size.
- The edges of still pictures recorded in this unit with a 16:9 aspect ratio may be cut off. When using a printer with a trimming or borderless printing function, cancel this function before printing. (Refer to the operating instructions of the printer for details.)
- When the unit is connected directly to the printer, the DPOF settings cannot be used.
- Connect the printer directly to this unit. Do not use a USB hub.

Preparation

Recording

Playback





Backup

With a PC

Others

- 96** Before using
- 101** Setup
- 105** Using with a PC

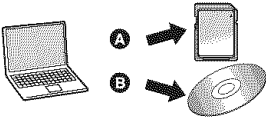
What you can do with a PC

Data type	Available function	Software required
Motion picture	Copying data to a PC: A Motion/Still pictures 	CD-ROM (supplied): HD Writer 2.5E for HDC*2 
	Writing data to media*1: A Motion/Still pictures B Motion pictures 	
	Copying data between media*1: C Motion pictures 	
	Easy editing: Editing motion picture data copied on an HDD of a PC <ul style="list-style-type: none"> • Split, merge, delete • Converting the motion picture data to MPEG2 • Creating a DVD Video disc 	
	Playing back on a PC: Play back the motion picture data on an SD card or a DVD disc in high definition picture quality on a PC.	
	Formatting discs: Depending on the type of disc that you use, formatting is necessary. Discs are formatted using the UDF 2.5 file system that supports the AVCHD format.	
Still picture	Playing back on a PC	Standard Windows picture viewer or a commercially available picture viewer
	Copying still pictures to a PC (→ 104)	Windows Explorer
Refer to page 106 if using a Macintosh.		

*1 Compatible media are SD card and discs (DVD-RAM, DVD-RW, DVD-R and DVD-R DL).

*2 Refer to the operating instructions of HD Writer 2.5E (PDF file) for details on how to use it.

Important Notice

- Do not insert a disc recorded in AVCHD format with HD Writer 2.5E in a device that does not support the AVCHD format. In some cases the disc may get stuck in the device. The disc will not play back on devices that do not support the AVCHD format.
- When inserting a disc containing recorded motion pictures into other devices, a message prompting you to format the disc may be displayed. Do not format the disc, since deleted data cannot be restored later.

- We cannot guarantee operation if you use software other than that supplied to read/write motion picture.
- Do not start the software supplied with this unit and other software at the same time. Close any other software if you start the software supplied with this unit and close the software supplied with this unit if you start any other software.
- Be sure to use the supplied USB cable when connecting this unit and a PC. (Operation is not guaranteed with any other USB cables.)



End User License Agreement

Before opening the CD-ROM package, please read the following.

You ("Licensee") are granted a license for the Software defined in this End User Software Agreement ("Agreement") on condition that you agree to the terms and conditions of this Agreement. If Licensee does not agree to the terms and conditions of this Agreement, promptly return the Software to Matsushita Electric Industrial Co., Ltd. ("Matsushita"), its distributors or dealers from which you made the purchase.

Article 1 License

Licensee is granted the right to use the software, including the information recorded or described on the CD-ROM, instruction manuals, and any other media provided to Licensee (collectively "Software"), but all applicable rights to patents, copyrights, trademarks and trade secrets in the Software are not transferred to Licensee.

Article 2 Use by a Third Party

Licensee may not use, copy, modify, transfer or allow any third party, whether free of charge or not, to use, copy or modify the Software, except as expressly provided for in this Agreement.

Article 3 Restrictions on Copying the Software

Licensee may make a single copy of the Software in whole or in part solely for back-up purposes.

Article 4 PC

Licensee may only use the Software on a single PC at a single location.

Article 5 Reverse Engineering, Decompiling or Disassembly

Licensee may not reverse engineer, decompile, or disassemble the Software, except to the extent either of them is permitted under law or regulation of the country where Licensee resides. Matsushita, or its distributors or dealers will not be responsible for any defects in the Software or damage to Licensee caused by Licensee's reverse engineering, decompiling, or disassembly of the Software.

Article 6 Limitation of Liability

The Software is provided "AS-IS" without warranty of any kind, either expressed or implied, including, but not limited to, warranties of non-infringement, merchantability and/or fitness for a particular purpose. Further, Matsushita does not warrant that the operation of the Software will be uninterrupted or error free. Matsushita or any of its distributors or dealers will not be liable for any damage suffered by Licensee arising from or in connection with Licensee's use of the Software.

Article 7 Export Control

Licensee agrees not to export or re-export to any country the Software in any form without the appropriate export licenses under regulations of the country where Licensee resides, if necessary.

Article 8 Termination of License

The right granted to Licensee hereunder will be automatically terminated if Licensee violates any of the terms and conditions of this Agreement. Upon such automatic termination, Licensee must destroy the Software and related documentation together with all the copies thereof at Licensee's own expense.

- Even if the system requirements mentioned in these operating instructions are fulfilled, some PCs cannot be used.
- A CD-ROM drive is necessary to install the supplied software applications. (A compatible DVD writer drive and media are necessary for writing to a DVD.)
- Operation is not guaranteed in the following cases.
 - When 2 or more USB devices are connected to a PC, or when devices are connected through USB hubs or by using extension cables.
 - Operation on an upgraded OS.
 - Operation on an OS other than the one pre-installed.
- This software is not compatible with Microsoft Windows 3.1, Windows 95, Windows 98, Windows 98SE, Windows Me and Windows NT.

■ Operating environment for HD Writer 2.5E for HDC

PC	IBM PC/AT compatible PC
OS	Microsoft Windows 2000 Professional Service Pack 4 Microsoft Windows XP Home Edition Service Pack 2 Microsoft Windows XP Professional Service Pack 2 Microsoft Windows Vista Home Basic Microsoft Windows Vista Home Premium Microsoft Windows Vista Ultimate Microsoft Windows Vista Business
CPU	Intel Pentium III 1.0 GHz or higher (including compatible CPU) (Intel Core 2 Duo 2.16 GHz or higher, Intel Pentium D 3.2 GHz or higher or AMD Athlon™ 64 X2 Dual-Core 5200+ or higher is recommended when a playback function or MPEG2 output function is used.)
RAM	Windows Vista: 1024 MB or more Windows XP/2000: 512 MB or more (1024 MB or more recommended)
Display	High Color (16 bit) or more (32 bit or more recommended) Desktop resolution of 1024×768 pixels or more (1280×1024 pixels or more recommended) Windows Vista: DirectX 10 compatible video card Windows XP/2000: DirectX 9.0c compatible video card Compatible with DirectDraw overlay PCI Express™×16 compatible recommended
Free hard disk drive space	Ultra DMA — 100 or more 300 MB or more (for installing the application) • When writing to a DVD, more than double the amount of free space as the disc being created is necessary.

Necessary software	Windows Vista: DirectX 10 Windows XP/2000: DirectX 9.0c <ul style="list-style-type: none"> • If you install the software on a PC that is not compatible with DirectX 9.0c, the PC may not work properly. If you are unsure whether or not your PC is compatible, contact the maker of your PC.
Sound	DirectSound Support
Interface	USB port [Hi-Speed USB (USB 2.0)]
Other requirements	Mouse or equivalent pointing device

- Supplied CD-ROM is available for Windows only.
- Input is not supported in languages other than English, French and Spanish.
- Operation cannot be guaranteed on all DVD drives.
- Operation is not guaranteed on Microsoft Windows Vista Enterprise, Windows XP Media Center Edition, Tablet PC Edition and not compatible with 64 bit operation systems.
- This software is not compatible with a multi-boot environment.
- This software is not compatible with a multi-monitor environment.
- If using Windows XP/2000, an administrative account user only can use this software. If using Windows Vista, administrative account and standard account users only can use this software. (An administrative account user should install and uninstall this software.)

■ Operating environment for the card reader function (mass storage)

PC	IBM PC/AT compatible PC
OS	Microsoft Windows 2000 Professional Service Pack 4 Microsoft Windows XP Home Edition Microsoft Windows XP Professional Microsoft Windows Vista Home Basic Microsoft Windows Vista Home Premium Microsoft Windows Vista Ultimate Microsoft Windows Vista Business Microsoft Windows Vista Enterprise
CPU	Windows Vista: Intel Pentium III 1.0 GHz or higher Windows XP/2000: Intel Pentium III 450 MHz or higher or Intel Celeron 400 MHz or higher
RAM	Windows Vista Home Basic: 512 MB or more Windows Vista Home Premium/Ultimate/Business/Enterprise: 1 GB or more Windows XP/2000: 128 MB or more (256 MB or more recommended)
Interface	USB port
Other requirements	Mouse or equivalent pointing device

- The USB equipment operates with the driver installed as standard in the OS.

When installing the software, log on to your PC as the Administrator (or with a user name with equivalent authorization) or with the user name for a standard user account. (If you do not have authorization to do this, consult your manager.)

- Before starting the installation, close all applications that are running.
- Do not perform any other operations on your PC while the software is being installed.

1 Insert the CD-ROM into the PC.

- If the installation screen does not appear automatically, double-click the CD-ROM drive icon in [My Computer (Computer)].

2 Click [Next].



3 Read the [End User License Agreement], then place a check beside [I accept the terms of the license agreement] if you agree to them and click [Next].

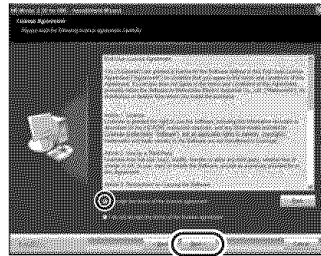

- If you do not agree to the terms and conditions of the License Agreement, installation is not possible.

4 Continue to follow the on-screen messages to install HD Writer 2.5E.

- If using Windows 2000, Microsoft DirectX 9.0c must be installed in order to operate HD Writer 2.5E.

Depending on the operating environment, you may be required to install DirectX 9.0c. Click [Yes] to install it.

If you install the software on a PC that is not compatible with DirectX 9.0c, the PC may not work properly. If you are unsure whether or not your PC is compatible, contact the PC manufacturer.

- 5** After the installation is complete, restrictions are displayed.
Check the contents, then close the window.

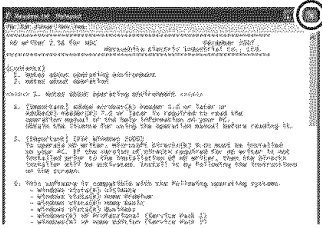

- 6** Click [Finish].



The PC must be rebooted for the application to work.

Uninstalling HD Writer 2.5E

Follow the steps below to uninstall any software applications that you no longer require.

- 1** Select [start] → ([Settings] →) [Control Panel] → [Add or Remove Programs (Applications)] or [Uninstall a program].

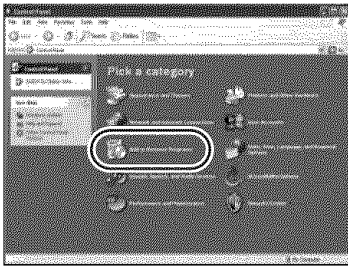

- 2** Select [HD Writer 2.5E for HDC], then click [Change/Remove] ([Change or Remove] or [Add/Remove]) or [Uninstall].

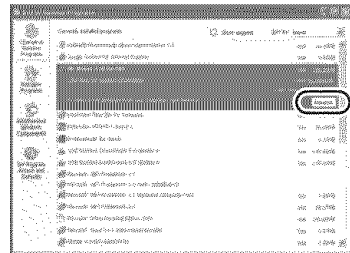

- Proceed with the uninstallation by following the on-screen instructions.
- After uninstalling the software, be sure to reboot the PC.



After the software applications are installed, this unit must be connected to the PC and be correctly recognized by the PC.

- Remove the supplied CD-ROM from your PC.

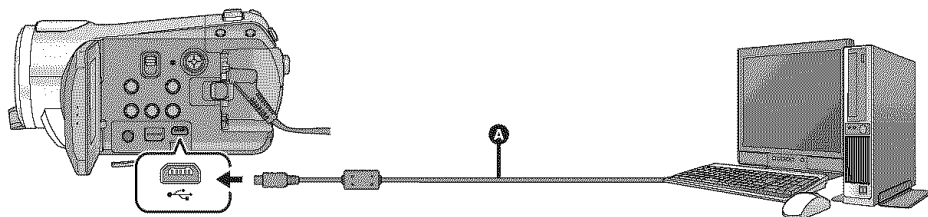

- A** USB cable (supplied)

1 Connect this unit to the AC adaptor.

- If a battery is used, operation is not possible when this unit is connected to a PC.

2 Turn on the unit.

- This function is available in all modes.

3 Connect this unit to a PC.

- Insert the USB connectors as far as they will go.
- Do not use any other USB connection cables except the supplied one. (Operation is not guaranteed with any other USB cables.)

4 Select [PC CONNECT] and press the cursor button.

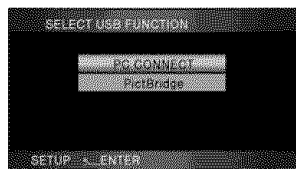

- This unit is automatically detected by the PC.
- When the unit is connected to a PC, the operation mode cannot be changed and its power cannot be turned off. Disconnect the USB cable, before turning this unit off (→ 103).

- Do not disconnect the USB cable or the AC adaptor while the card access lamp is on or card access icon () appears on the LCD monitor. Doing so may damage the data.

■ If the driver has not been recognized properly

Use the following methods to enable it to be recognized.

Method 1:

Turn off the unit and your PC once and try verifying again.



Method 2:

Remove the SD card and try verifying again.

Method 3:

Try connecting the unit to another USB port on your PC.

■ To disconnect USB cable safely

- 1 Double click the  () icon in task tray displayed on the PC.
- Depending on your PC's settings, this icon may not be displayed.
- 2 Select [USB Mass Storage Device] and click [Stop].
- 3 Verify [MATSHITA HDC-SD9/SD USB Device] is selected and click [OK].

About the PC display

When the unit is connected to a PC, it is recognized as an external drive.

- [Removable Disk] (Example: ) is displayed in [My Computer (Computer)].

Example folder structure of an SD card:

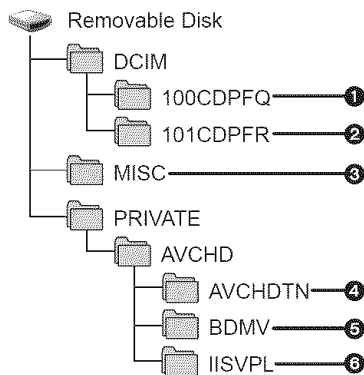

We recommend using HD Writer 2.5E to copy or write back motion picture data recorded on an SD card.

Using Windows Explorer or other programs on the PC to copy, move or rename files and folders recorded with this unit will result in them being unusable with HD Writer 2.5E.

- 1 Up to 999 still pictures in JPEG format* can be stored. ([IMG0001.JPG] etc.)
 - 2 Still pictures are stored in JPEG format* when recorded in HD hi-speed burst shooting mode.
- * These can be opened with picture software that supports JPEG pictures.
- 3 The DPOF setting files are recorded.
 - 4 The motion picture thumbnails are recorded.
 - 5 AVCHD format motion picture files are saved. ([00000.MTS] etc.)
 - 6 Files for intelligent scene selection playback are recorded.

■ Copying your still pictures to your PC

Card reader function (mass storage)

Still pictures recorded with this unit can be copied to the PC with Explorer or other programs.

- 1 Connect this unit to the PC and then select [PC CONNECT].
- 2 Double click the folder that contains the still pictures on the removable disk ([DCIM] → [100CDPFQ] etc.).
- 3 Drag and drop the still pictures onto the destination folder (on the PC's HDD).

- Do not delete the SD card's folders. Doing so may make the SD card unuseable in this unit.
- When data not supported by this unit has been recorded on a PC, it will not be recognized by this unit.
- Always use this unit to format SD cards.

Starting HD Writer 2.5E

- When using HD Writer 2.5E on Windows XP/2000, log on to your computer as Administrator (or with a login name equally authorized). If you log on with a login name other than Administrator, you cannot use the applications.
- When using HD Writer 2.5E on Windows Vista, log on to your computer as Administrator (or with a login name equally authorized) or with the user name for a standard user account. If you log on with a user name for a guest user account, the software cannot be used.

(On the PC)

Select **[start]** → **[All Programs (Programs)]** → **[Panasonic]** → **[HD Writer 2.5E]** → **[HD Writer]**.



The HD Writer 2.5E introductory screen is displayed. If [OK] is clicked, the software will start.

- For details on how to use the software applications, read the PDF operating instructions of the software.

Reading the operating instructions of the software applications

For details on how to use the software applications, read the PDF operating instructions.

- You will need Adobe Acrobat Reader 5.0 or later or Adobe Reader 7.0 or later to read the PDF operating instructions.

Select **[start]** → **[All Programs (Programs)]** → **[Panasonic]** → **[HD Writer 2.5E]** → **[Operating Instructions]**.



- HD Writer 2.5E is not available for Macintosh.

■ Operating environment for the card reader function (mass storage)

PC	Macintosh
OS	Mac OS X 10.4
CPU	PowerPC G5 (1.8 GHz or higher) Intel Core Duo Intel Core Solo
RAM	64 MB or more
Interface	USB port

- Even if the system requirements mentioned in these operating instructions are fulfilled, some PCs cannot be used.
- The USB equipment operates with the driver installed as standard in the OS.
- Supplied CD-ROM is available for Windows only.

■ Copying still pictures on PC

1 Connect this unit to a PC via the supplied USB cable.

- The USB function selection screen will appear.

2 Select [PC CONNECT] and press the cursor button.

3 Double-click [NO_NAME] or [Untitled] displayed on the desktop.

- Files are stored in [100CDPFQ] or [100CDPFR] folder etc. in the [DCIM] folder.

4 Using a drag-and-drop operation, move the pictures you want to acquire or the folder storing those pictures to any different folder on the PC.

■ To disconnect USB cable safely

Drag [NO_NAME] or [Untitled] disk icon to the [Trash], and then disconnect the USB cable.

Preparation

Recording

Playback

Backup

With a PC

Others

108 Indications

113 Helpful hints

■ Recording indications

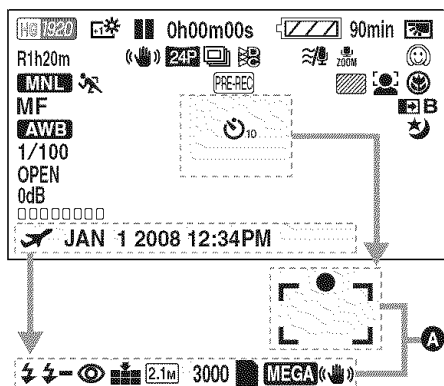

Motion picture recording



A Still picture recording
(when the button is pressed)

	Remaining battery power (→ 22)
90min	Remaining battery time (→ 22)
R1h20m	Remaining time for motion picture recording (→ 37)
0h00m00s	Elapsed recording time (→ 37)
JAN 1 2008	Date indication (→ 30)
12:34PM	Time indication (→ 30)
	World time setting (→ 31)
	Motion picture recording mode (→ 38)
	HA mode
	HG mode
	HX mode
	HE mode
	Recording (→ 36)
	Recording pause (→ 36)
	PRE-REC (→ 40)
	Auto mode (→ 35)
	Manual mode (→ 59)
MF	Manual focus (→ 60)

	White balance (→ 61)
	Auto white balance
	Indoor mode (recording under incandescent lamp)
	Outdoor mode
	Manual adjustment mode
1/100	Shutter speed (→ 62)
OPEN, F2.0	F number (→ 62)
0dB	Gain value (→ 62)
	Scene mode (→ 59)
	Sports mode
	Portrait mode
	Spotlight mode
	Surf & snow mode
	Low light mode (→ 49)
	Power LCD Extra (→ 32)
	Image stabilizer (→ 45)
	Zebra (→ 56)
	24pDIGITAL CINEMA (→ 51)
	HI-SPEED BURST (→ 54)
	Digital cinema color (→ 57)
10x	Zoom magnification indication (→ 44)
	Zoom microphone (→ 52)
	Focus microphone (→ 52)
	Wind noise reduction (→ 52)
	Microphone level (→ 53)
	Face detection & AE mode (→ 46)
	Backlight compensation (→ 49)
	Soft skin mode (→ 49)
	Tele macro (→ 49)
	Fade (White), Fade (Black) (→ 48)
	MagicPix function (→ 49)

	Intelligent contrast control (→ 48)
○ (White) ● (Green)	Focus indication (→ 41)
🕒 10, 🕒 2	Self-Timer recording (→ 49)
🔋/🔋A/🔋	Flash (→ 55)
🔋+/🔋-	Flash level (→ 55)
👁️	Red eye reduction (→ 55)
	Still picture quality (→ 43)
	Number of recording pixels for still pictures (→ 43)
2.1M	1920×1080
3000	Remaining number of still pictures (→ 42)
📷 (White)	Card can be recorded to (→ 42)
📷 (Green)	Recognizing the card (→ 42)
📷 (Red)	Recording/accessing the card (→ 42)
MEGA 	MEGA OIS (→ 42)

■ Playback indications



Motion picture playback



Still picture playback



▶	Playback (→ 65, 70)
⏸	Pause (→ 65, 70)
⏩, ⏪/⏴, ⏴⏴	Fast forward/rewind playback (→ 65)
⏪/⏴	Last/first scene paused
⏩/⏴⏴	Skip playback (→ 65)
⏩/⏴	Slow motion playback (→ 66)
⏮/⏭	Frame-by-frame playback (→ 66) Next/Previous still picture (→ 70)
0h00m00s	Playback time
	Play mode (→ 65)
ALL	All scenes
DATE	Scenes recorded on the selected date
★	Intelligent scene selection
	Number of recording pixels for motion pictures (→ 38)
1920	1920×1080
1440	1440×1080
No.10	Scene number
🔊 15 	Volume adjustment (→ 65)
🔄	Repeat playback (→ 68)
⏩	Resume playback (→ 68)

100-0001	Still picture folder/file name (→ 69)
PictBridge	When a printer compatible with PictBridge is connected (→ 93)
 1	DPOF already set (to more than 1) (→ 76)
	Protected still pictures (→ 75)
	Number of recording pixels for still pictures (→ 43) 1920×1080

The picture size is not displayed for still pictures recorded with other products that have different picture sizes from the sizes shown above.

■ PC connection indications

 Accessing the card (When connected to a PC) (→ 103)

■ Confirmatory indications

-- (Time display) The built-in battery is low. (→ 30)

 The warning/alarm indication appears when LCD monitor is rotated towards the lens side. Return the direction of the LCD monitor to normal position and check the warning/alarm indication.

 No SD card is inserted/unusable card.

■ Confirmatory indications when a DVD burner is connected

 Disc type (→ 86)
DVD-RAM

 DVD-RW

 DVD-R

 DVD-R DL (Dual layer on single side)

 Unusable disc

Major confirmation/error messages to be indicated on the LCD monitor in text.

**CANNOT BE USED DUE TO INCOMPATIBLE DATA.
CANNOT RECORD - INCOMPATIBLE CONTROL DATA.**

The recording format of the SD card is different so it cannot be used. Save the data on the SD card to a PC, then use the SD card after formatting it on this unit.

CHECK CARD.

This card is not compatible or it cannot be recognized by the unit.

If this message appears even though motion pictures and still pictures are recorded on an SD card, the card may be unstable. Reinsert the SD card, then turn the power off and then on again.

CARD LOCKED.

The write protection switch on the SD card is set to LOCK. (→ 24)

THIS BATTERY CANNOT BE USED.

- Use a battery that is compatible with this unit. (→ 22)
If using a Panasonic battery compatible with this unit, eject the battery and then insert it again. If the message appears even after repeating this several times, this unit needs repair. Detach the power and contact consumer support. (→ 136, 137) Do not attempt to repair it by yourself.
- You are attempting to connect an AC adaptor not compatible with this unit. Use the supplied AC adaptor. (→ 23)

PUSH THE RESET SWITCH.

An irregularity in the unit has been detected. Press the RESET button to restart the unit. (→ 118)

CANNOT CHECK CONNECTED DEVICE. DISCONNECT THE USB CABLE FROM THIS UNIT.

- The DVD burner is not correctly connected.
Disconnect and then reconnect the Mini AB USB Connection Cable.
- Connect a DVD burner that is compatible with this unit. (→ 86)

PLEASE CHECK EXTERNAL DRIVE OR DISC.

A disc that cannot be used when connecting the unit to the DVD burner has been inserted, or the DVD burner is not recognized properly. Connect the Mini AB USB Connection Cable again and insert a disc to copy the data. (→ 86)

CANNOT COPY TO DISC WITH RECORDED IMAGES. INSERT DISC WITH NO RECORDED IMAGES.

Data cannot be copied since a disc that cannot be used by connecting the unit and the DVD burner or a used disc is inserted. Please use a new disc. (→ 86)

DISCONNECT USB CABLE.

The unit cannot correctly establish the connection to the PC or printer. Disconnect and then reconnect the USB cable.

DISCONNECT USB CABLE.

You cannot turn off this unit while it is connected to a PC or a DVD burner.

About recovery

If faulty management information is found when a SD card is accessed, one of the following messages may appear. Be sure to follow the messages. (Repairing may take time depending on the error.)

CONTROL DATA ERROR HAS BEEN DETECTED. (SD CARD)

or

THUMBNAIL DATA ERROR IS DETECTED.

- Use a sufficiently charged battery or the AC adaptor.
- Depending on the condition of the data, it may not be possible to completely repair the data.
- If the recovery fails, you will no longer be able to play back the scenes recorded before the power went off.
- When data recorded on another device is recovered, it may not be possible to play back the data on this unit or the other device.
- If recovery fails, turn the power of the unit off and on again after waiting a while. If recovery fails repeatedly, format an SD card on the unit. Please be aware that if an SD card is formatted, then all the data recorded on the card will be erased. Back up important data on a PC, DVD disc etc.
- If the thumbnail information is recovered, displaying the thumbnails may become slower.

Functions that cannot be used simultaneously

Some functions in this unit are disabled or cannot be selected due to the unit's specifications. The table below shows examples of functions restricted by various conditions.

Functions	Conditions which disable the functions
Motion picture recording	<ul style="list-style-type: none"> When the HD hi-speed burst shooting mode is on
PRE-REC	
Zoom	<ul style="list-style-type: none"> When the  button is pressed halfway
Digital zoom	<ul style="list-style-type: none"> When 24p digital cinema is used When the HD hi-speed burst shooting mode is on
Face detection & AE mode	<ul style="list-style-type: none"> When the MagicPix function is used When the color bars are displayed
Backlight compensation	<ul style="list-style-type: none"> When the MagicPix function is used When the iris/gain is set
Intelligent contrast control	
Low light	<ul style="list-style-type: none"> When the MagicPix function is used When the scene mode is used When the HD hi-speed burst shooting mode is on
MagicPix (Set and cancel)	<ul style="list-style-type: none"> While recording When PRE-REC is used
Soft skin mode (Set and cancel)	
Tele macro (Set and cancel)	
Help mode	
Fade	<ul style="list-style-type: none"> When PRE-REC is used When the HD hi-speed burst shooting mode is on
MagicPix	<ul style="list-style-type: none"> When 24p digital cinema is used When the HD hi-speed burst shooting mode is on
Guide lines	<ul style="list-style-type: none"> When the face detection & AE mode is used
24p digital cinema	<ul style="list-style-type: none"> When the motion picture recording mode is HX/HE When the digital zoom is set to [25×] or [700×]
HD hi-speed burst shooting mode	<ul style="list-style-type: none"> When the digital zoom is set to [25×] or [700×]
Shutter sound	<ul style="list-style-type: none"> While recording motion pictures When PRE-REC is used

Functions	Conditions which disable the functions
Flash	<ul style="list-style-type: none"> ● While recording motion pictures ● When PRE-REC is used ● When the MagicPix function is used ● When the HD hi-speed burst shooting mode is on
Auto slow shutter	<ul style="list-style-type: none"> ● When the HD hi-speed burst shooting mode is on
Digital cinema color	<ul style="list-style-type: none"> ● When the MagicPix function is used ● When the HD hi-speed burst shooting mode is on
Scene mode	<ul style="list-style-type: none"> ● When the low light mode is used ● When setting the AUTO/MANUAL/FOCUS switch to AUTO ● When the MagicPix function is used ● When the HD hi-speed burst shooting mode is on
MF assist function	<ul style="list-style-type: none"> ● When digital zoom (10× or higher) is used
Change of white balance	<ul style="list-style-type: none"> ● When digital zoom (10× or higher) is used ● When the MagicPix function is used
Adjusting the shutter speed, iris/gain	<ul style="list-style-type: none"> ● When the MagicPix function is used ● When the low light mode is used ● When the scene mode is used ● When the HD hi-speed burst shooting mode is on

Problem

This unit cannot be turned on.

This unit does not stay on long enough.

Battery runs down quickly.

This unit is turned off automatically.

The minute display of the remaining battery power indication is not displayed correctly.

Check points

- Charge the battery using the AC adaptor. (→ 20)
- The battery protection circuit may have operated. Attach the battery to the AC adaptor for 5 to 10 seconds. If the unit still cannot be used, the battery is faulty.
- Make sure the LCD monitor is opened.
- The battery is affected by ambient temperature. In cold places, the battery using time becomes shorter.
- The battery has a limited life. If the operating time is still too short even after the battery is fully charged, the battery has worn out and needs to be replaced.

- If you do not use the unit for approximately 5 minutes, the power is automatically turned off to conserve battery life. To resume recording, turn the power back on. The power will not turn off automatically when the power save function (→ 28) is set to [OFF].
- If you connect to a TV compatible with VIERA Link with a HDMI mini cable and turn off the power on the TV with the remote control for the TV, the power on this unit also turns off. If you are not using VIERA Link, set [VIERA Link] to [OFF]. (→ 83)
- When this unit is connected to a DVD burner to copy or play back images (a disc is being accessed), the power turns off automatically if the Mini AB USB connection cable is removed.

- The remaining battery capacity indication is an approximation. If you think the remaining battery capacity indication is not displayed correctly, fully charge the battery, discharge it and then charge it again. (Even if this operation is performed, it may not be possible to display the remaining battery capacity correctly if the battery was used for a long period of time where the temperature was low or high or if the battery was repeatedly charged.)

Problem

This unit cannot be operated though it is turned on.

This unit does not operate normally.



The remote control does not function.



The remaining time indication or the elapsed time indication is not shown.



Recording does not start although power is supplied to this unit and the SD card is correctly inserted.



The unit arbitrarily stops recording.



Color balance of images is strange when recording in a place such as a gymnasium.



Auto focus function does not work.



Check points

- The unit cannot be operated if the LCD monitor is not opened.
- Press the RESET button. (→ 118) If normal conditions are not restored yet, remove the battery or AC adaptor, wait about 1 minute and then reconnect the battery or AC adaptor. Then about 1 minute later, turn on the power again. (Conducting the above operation while the SD card is being accessed may damage the data on the SD card.)

- The button-type battery of the remote control may be run out. Replace it with a new button-type battery. (→ 19)

- If you set [SETUP] → [DISPLAY] → [OFF], all indications other than warnings and date are not displayed.

- Operate the mode switch to select .
- No recording is possible while the SD card's write protect switch is set to LOCK. (→ 24)
- If there is no more available memory of the SD card, free up some memory by deleting unnecessary scenes or use a new SD card. (→ 25, 72)
- If the SD card cover is open, this unit may not operate normally. Close the SD card cover.

- Use an SD card that can be used for motion picture recording. (→ 24)
- If [AGS] is [ON], record in the normal horizontal position or set [AGS] to [OFF]. (→ 35)

- In a place with multiple light sources, such as a gymnasium or a hall, the auto white balance function may not operate properly. In this case, adjust the white balance setting manually. (→ 61)

- Set the AUTO/MANUAL/FOCUS switch to AUTO.
- If you are trying to record a scene which is hard to bring into focus in auto focus mode, use the manual focus mode to adjust the focus. (→ 60, 127)

Problem

Check points

Recorded still pictures are not clear.



- If you are trying to record small or finely detailed objects with [PICT.QUALITY] set at [], the images may break up into a mosaic-like pattern. Record with [PICT.QUALITY] set at [] instead. (→ 43)

Some playback images are skipped automatically.



- The playmode is set to [] (Intelligent scene selection). Change the playmode to [ALL] (All scenes). (→ 67)

Although this unit is correctly connected to a TV, images cannot be seen.



The images are squeezed horizontally.

- Please read the operating instructions of your TV and select the channel that matches the input used for the connection.
- Change the [TV ASPECT] setting to match the aspect ratio of the TV.
- If both HDMI mini cable and component cable are connected, set the unit to playback mode.

Scenes cannot be deleted.



- Protected scenes cannot be deleted. Release the protect setting. (→ 75)
- Any scenes/still pictures where the thumbnails are displayed as [] cannot be deleted. If the scenes/still pictures are unnecessary, format the SD card to erase the data. (→ 77) Please be aware that if an SD card is formatted then all the data recorded on the SD card is erased and cannot be recovered. Back up important data on a PC, DVD disc etc.
- If the SD card's write protect switch is set to LOCK, then deletion is disabled. (→ 24)

The images on the SD card do not look normal.



- The data may be destroyed. It may have been destroyed by static or electromagnetic waves. Back up important data on a PC, DVD disc etc. as well.

If the SD card is inserted in this unit, it is not recognized.



- If the SD card is formatted on a PC, it may not be recognized by this unit. Use this unit to format SD cards. (→ 77)

If the SD card is inserted in another device, it is not recognized.



- Check that the device is compatible with the capacity or type of SD card (SD Memory Card/SDHC Memory Card) that you inserted. Refer to the operating instructions of the device for details.

Problem

The indication disappears.

The screen is frozen.

No operation can be performed.



White round spots like soap bubbles appear on the recorded picture.



“PUSH THE RESET SWITCH.” is displayed.



Check points

- No operation can be performed on this unit when it is connected to a PC.
- Turn off the power to this unit. If the power cannot be turned off, press the RESET button, or remove the battery or AC adaptor and then reattach it. Turn on the power again. If normal operation is still not restored, detach the power connected, and contact consumer support. (→ 136, 137)

- If you take a picture with the flash in a dark place or indoors, white round spots may appear on the picture caused by the flash reflecting of particles of dust in the air. This is not a malfunction.



A characteristic of this is that the number of round spots and their position differ in every picture.

- The unit has automatically detected an error. Press the RESET button with the projecting part of the grip belt **A**. This will restart the unit.

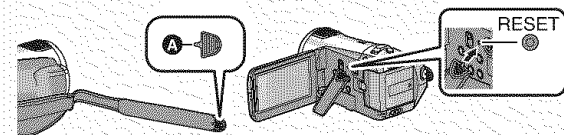

- If you do not press the RESET button, the power to this unit is turned off automatically about 1 minute later.
- Even after you press the RESET button, the indication may still appear repeatedly. If so, this unit needs repair. Detach the power connected, contact consumer support. (→ 136, 137) Do not attempt to repair the unit by yourself.

Problem

VIERA Link does not work.



- Connect with a HDMI mini cable (optional). (→ 83)
- Press the MENU button, then select [SETUP] → [VIERA Link] → [ON] with the cursor button. (→ 83)
- Depending on HDMI terminal of the TV, the input channel may not switch automatically. In this case, use the remote control for the TV to switch input. (For details on how to switch input, please read the operating instructions for the TV.)
- Check the VIERA Link setting on the connected device.
- Turn the power to the unit off and then back on again.
- Set [EZ Sync] to [Off] on the TV and then turn it back to [On]. (Refer to the operating instructions of the TV for details.)



When connected by the USB cable, this unit is not detected by the PC.



- Use AC adaptor when connecting this unit and a PC.
- Select another USB terminal on the PC.
- Check the operating environment. (→ 99)
- Turn the power to the unit off and then back on again and reconnect the USB cable.

When the USB cable is disconnected, an error message will appear on the PC.



- To disconnect the USB cable safely, double-click the  () icon in the task tray and follow the instructions on the screen.

The power of the DVD burner cannot be turned on.



- When the unit is connected to the DVD burner, use the respective AC adaptors for both this unit and the DVD burner.

Cannot see the PDF operating instructions for HD Writer 2.5E.



- You will need Adobe Acrobat Reader 5.0 or later or Adobe Reader 7.0 or later to read the PDF operating instructions for HD Writer 2.5E.

■ If scenes do not change smoothly when played back on another device

The images may be still for several seconds at the joins between the scenes if the following operations are performed when multiple scenes have been continuously played back using another unit.

* Just how smoothly the scenes will be played back depends on the playback unit. Depending on the unit used, the images may stop moving and become still for a moment even when none of the following conditions are applicable.

■ When the scenes were recorded on different dates

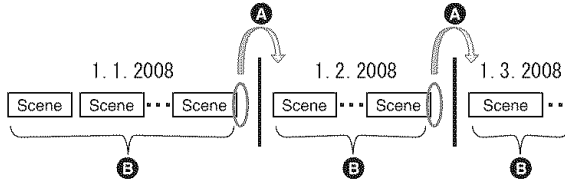

- A** The image will be still for several seconds wherever the date changes.
- B** The images are played back smoothly if the scenes were recorded on the same date.

■ When more than 99 scenes were recorded on the same date

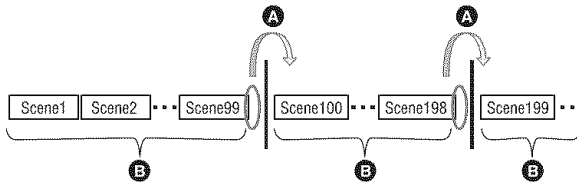

- A** The image will be still for several seconds when the scene changes every time 99 recorded scenes have been played back.
- B** The images of 99 consecutive scenes are played back smoothly.

■ When scenes lasting under 3 seconds have been recorded

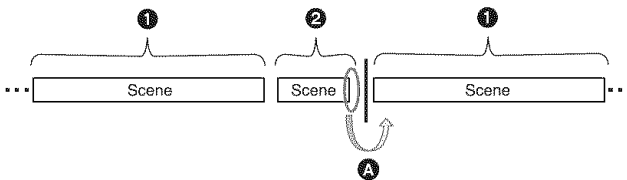

- 1** 3 or more seconds
- 2** Under 3 seconds
- A** The image will be still for several seconds after a scene which lasts under 3 seconds.

■ When PRE-REC was used for recording

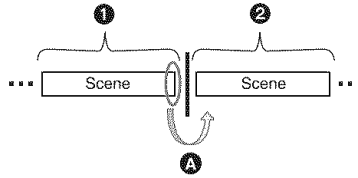

- 1 Normal recording
- 2 PRE-REC recording
- A The picture momentarily stops at the end of the last scene that was recorded normally before PRE-REC recording.

■ When the recording mode was changed from HA/HG/HX to HE or from HE to HA/HG/HX

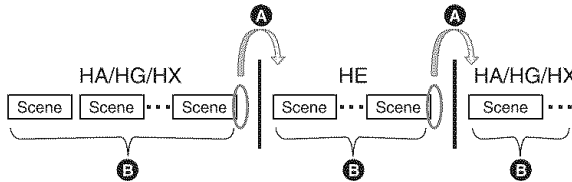

- A The picture momentarily stops where the scenes switch between HA/HG/HX and HE modes.
- B Playback is smooth if the same mode is used or the mode is switched among HA, HG and HX.

■ When the settings on the 24p digital cinema change

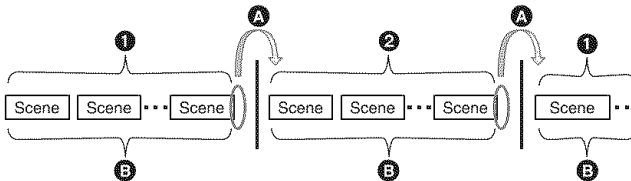

- 1 [24pDIGITAL CINEMA] is [ON].
- 2 [24pDIGITAL CINEMA] is [OFF].
- A When recording motion pictures after changing settings on the 24p digital cinema, the motion pictures at the switching points of scenes stop for several seconds.
- B Scenes with the same settings can be played back smoothly at the switching points.

■ When deleting scenes

■ Example 1: Deleting scenes midway through a sequence of scenes.

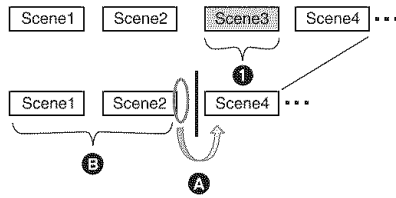

- 1 Scene to be deleted
- A The image will be still for several seconds wherever a scene was deleted.
- B The images of consecutive scenes where they are no deletions are played back smoothly one after another.

■ Example 2: When recording again after having deleted the last scene.

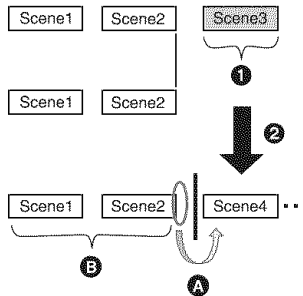

- 1 Scene to be deleted
- 2 A new scene is recorded here.
- A The image will be still for several seconds wherever a scene was deleted.
- B The images of consecutive scenes where they are no deletions are played back smoothly one after another.

■ If you connected this unit and the DVD burner, selected scenes and then copied them to 1 disc.

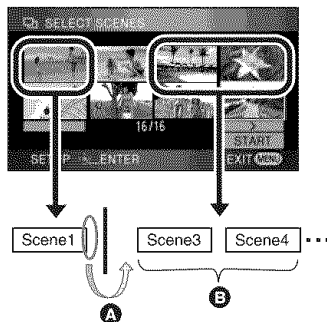

- A If you select a scene other than the next scene, the picture may momentarily stop at the point where the scenes switch.
- B The point where the scenes switch will be played back smoothly if you select the scenes in order.

■ When editing scenes on a PC using a software such as HD Writer 2.5E

■ Example 1: When scenes were selected using HD Writer 2.5E and output to the media

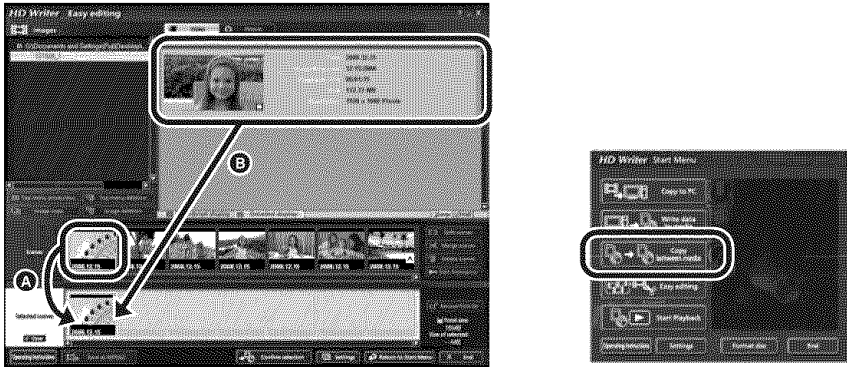

If scenes were dragged and dropped from the scene display area **A** and output to the media, the images will be still for several seconds wherever one scene changes to the next.

This stopping of the images for several seconds wherever one scene changes to the next can be prevented by dragging and dropping the scenes in the Image display area **B** or by clicking [Copy between media] button on the Start Menu.

■ Example 2: When deleting scenes was initiated by HD Writer 2.5E



When a scene is deleted, the images may be still for several seconds where that scene was deleted.

■ Example 3: When merging scenes was initiated by HD Writer 2.5E



Wherever scenes are merged, the images may be still for several seconds at the merged parts.

■ Example 4: When edit assist is initiated by HD Writer 2.5E



When edit assist is initiated, the motion pictures at the switching points of the respective scenes or edited portions may stop for several seconds.

Cautions for use

About this unit

The unit and the SD card become warm during use. This is not a malfunction.

Keep the High Definition Video Camera as far away as possible from electromagnetic equipment (such as microwave ovens, TVs, video games etc.).

- If you use the High Definition Video Camera on top of or near a TV, the pictures and sound on the High Definition Video Camera may be disrupted by electromagnetic wave radiation.
- Do not use the High Definition Video Camera near cell phones because doing so may result in noise adversely affecting the pictures and sound.
- Recorded data may be damaged, or pictures may be distorted, by strong magnetic fields created by speakers or large motors.
- Electromagnetic wave radiation generated by microprocessors may adversely affect the High Definition Video Camera, disturbing the pictures and sound.
- If the High Definition Video Camera is adversely affected by electromagnetic equipment and stops functioning properly, turn the High Definition Video Camera off and remove the battery or disconnect AC adaptor. Then reinsert the battery or reconnect AC adaptor and turn the High Definition Video Camera on.

Do not use the High Definition Video Camera near radio transmitters or high-voltage lines.

- If you record near radio transmitters or high-voltage lines, the recorded pictures and sound may be adversely affected.

Make sure to use the supplied cords and cables. If you use optional accessories, use the cords and the cables supplied with them. Do not extend the cords and the cables.

Do not spray insecticides or volatile chemicals onto the unit.

- If the unit is sprayed with such chemicals, its body may be marred and the surface finish may peel off.

- Do not leave rubber or plastic products in contact with the unit for a long time.

When you use the unit in a sandy or dusty place such as a beach, do not let sand or fine dust get into the body and terminals of the unit.

Also, keep the unit away from sea water.

- Sand or dust may damage the unit. (Care should be taken when inserting and removing a card.)
- If sea water splashes onto the unit, wipe off the water with a well wrung cloth. Then wipe the unit again with a dry cloth.

When carrying the unit, do not drop or bump it.

- A strong impact can break the unit's casing, causing it to malfunction.

Cleaning

- Before cleaning, detach the battery or pull the AC cable from the AC outlet, and then wipe the unit with a soft, dry cloth.
- If the unit is very dirty, dip a cloth in water and squeeze firmly, and then wipe the unit with the damp cloth. Next, dry the unit with a dry cloth.
- Use of benzine, paint thinner, alcohol, or dishwashing liquid may alter the camera body or peel the surface finish. Do not use these solvents.
- When using a chemical dust cloth, follow the instructions that came with the cloth.

Do not use the unit for surveillance purposes or other business uses.

- This unit was designed for consumer intermittent use. It was not intended for continuous use, or for any industrial or commercial application resulting in prolonged use.
- In certain situations, continuous use could cause the unit to overheat and cause a malfunction. Such use is strongly discouraged.

When you are not going to use the unit for an extended time

- When storing the unit in a cupboard or cabinet, it is recommended that you place a desiccant (silica gel) in with it.

About the battery

The battery used in this unit is a rechargeable lithium-ion battery. It is susceptible to humidity and temperature and the effect increases the more the temperature rises or falls. In cold areas, the full charge indication may not appear or the low battery indication may appear about 5 minutes after starting use. At high temperatures, the protection function may be triggered, making it impossible to use the unit.

Be sure to detach the battery after use.

- If the battery is left attached, a minute amount of current continues to flow even if the unit's power is off. Keeping the unit in this state may result in over discharge of the battery. This may result in you not being able to use the battery even after it is charged.
- The battery should be stored in the vinyl bag so metal does not come into contact with the terminals.
- The battery should be stored in a cool place free from humidity, with as constant temperature as possible. (Recommended temperature: 15 °C to 25 °C (59 °F to 77 °F), Recommended humidity: 40% to 60%)
- Extremely high temperatures or low temperatures will shorten the life of the battery.
- If the battery is kept in high-temperature, high-humidity, or oily-smoky places, the terminals may rust and cause malfunctions.
- To store the battery for a long period of time, we recommend you charge it once every year and store it again after you have completely used up the charged capacity.
- Dust and other matter attached to the battery terminals should be removed.

Prepare spare batteries when going out for recording.

- Prepare batteries enough to last for 3 to 4 times the period you are planning to record for. Cold places such as a ski resort can shorten the period which you can record for.

If you drop the battery accidentally, check to see if the terminals are damaged.

- Attaching a battery with damaged terminals can damage the unit or AC adaptor.

Do not throw old battery into fire.

- Heating a battery or throwing it into a fire may result in an explosion.

If the operating time is very short even after the battery has been recharged, the battery has worn out. Please purchase a new battery.

About the AC adaptor

- If the temperature of the battery is extremely high or extremely low, charging may take time or the battery may not be charged.
- If the charging lamp keeps flashing, make sure that the terminals of the battery or the AC adaptor are not exposed to dirt, foreign objects or dust, then reconnect them properly. Disconnect the AC cable from the AC outlet when you remove dirt, foreign objects or dust on the terminals of the battery or the AC adaptor. If the charging lamp is still flashing, the temperature of the battery may be extremely high or extremely low or something may be wrong with the battery or AC adaptor. Contact consumer support. (→ 136, 137).
- If you use the AC adaptor near a radio, radio reception may be disturbed. Keep the AC adaptor 1 m (3.3 feet) or more away from the radio.
- When using the AC adaptor, it may generate whirring sounds. However, this is normal.
- After use, be sure to disconnect the AC adaptor. (If it is left connected, a minute amount of current is consumed.)
- Always keep the electrodes of the AC adaptor and battery clean.

LCD monitor

- When the LCD monitor gets dirty, wipe it with a dry soft cloth.
- In a place with drastic temperature changes, condensation may form on the LCD monitor. Wipe it with soft dry cloth.
- When the unit has become very cold, for example due to storage in a cold area, its LCD monitor will be slightly darker than usual immediately after the power is turned on. The normal brightness will be restored when the unit's internal temperature rises.

Extremely high precision technology is employed to produce the LCD Monitor screen featuring a total of approximately 300,000 pixels. The result is more than 99.99% effective pixels with a mere 0.01% of the pixels inactive or always lit. However, this is not a malfunction and does not affect the recorded picture.

About condensation

When condensation forms on the unit, the lens will cloud up and the unit may not work properly. Make every effort to ensure that condensation does not form. If it does form, take the actions described below.

Causes of condensation

Condensation takes place when the ambient temperature or humidity is changed as follows.

- When this unit is brought inside from the cold (e.g. a ski slope) to a warm room.
- When this unit is moved from an air-conditioned car to outside.
- When a cold room has been warmed up quickly.
- When cool wind from an air conditioner is directly blown onto this unit.
- After summer afternoon showers of rain.
- When this unit is in a very humid place where the air is thick with steam. (e.g. a heated swimming pool)

Helpful hint

If, for example, you have used this unit for recording on a ski slope and are taking it into a heated room, place the unit inside a plastic bag, remove as much of the air from inside the bag as possible, then seal the bag. Leave the unit for about an hour in the room so the temperature of the unit is close to the ambient temperature of the room, then use it.

Explanation of terms

Automatic white balance

White balance adjustment recognizes the color of light and adjusts so the white color will become a purer white. The unit determines the hue of light that comes through the lens, thereby judging the recording condition, and selects the closest hue setting.

This is called automatic white balance adjustment.

However, since the unit only stores white color information under several light sources, automatic white balance adjustment does not function normally under other light sources.

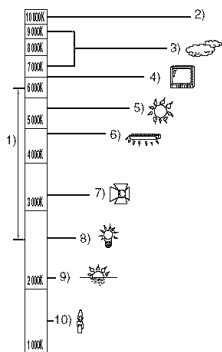

The illustration above shows the range over which the auto white balance functions.

- 1) The effective range of automatic white balance adjustment on this unit
- 2) Blue sky
- 3) Cloudy sky (rain)
- 4) TV screen
- 5) Sunlight
- 6) White fluorescent lamp
- 7) Halogen light bulb
- 8) Incandescent light bulb
- 9) Sunrise or sunset
- 10) Candlelight

Outside of the effective range of automatic white balance adjustment, the image will become reddish or bluish. Even within the effective range of automatic white balance adjustment, the automatic white balance adjustment may not function properly if there is more than one light source. For light outside the functional automatic

white balance adjustment range, use the manual white balance adjustment mode.

White balance adjustment

White balance adjustment determines the white color under different light sources. By recognizing which is the white color under sunlight and which is the white color under a fluorescent light, the unit can adjust the balance among the other colors.

Since the white color is the reference for all the colors, the unit can record pictures in a natural hue if it can recognize the reference color white.

Auto focus

The lens is moved forward or backward automatically to bring the subject into focus.

Auto focus has the following characteristics.

- Adjusts so that the vertical lines of a subject are seen more clearly.
- Attempts to bring an object with higher contrast into focus.
- Focuses on the screen center only.

Due to these characteristics, auto focus does not work correctly in the following situations. Record pictures in the manual focus mode.

Recording distant and close-up objects at the same time

Since the unit focuses on whatever is at the center of the screen, it is difficult to bring the background into focus when close-up objects are placed in focus. When recording people with distant mountains in the background, you cannot focus on both the subject which is close-up and the objects which are in the distance.

Recording a subject behind dirty or dusty window

The subject behind the window will not be focused because the focus is on the dirty window.

Similarly, when recording something on the opposite side of a road with heavy traffic, a vehicle that happens to pass by may be brought into focus.

Recording a subject that is surrounded by objects with glossy surfaces or by highly reflective objects

Since whatever is shiny or glistens is brought into focus, it is hard to focus on the subject to be recorded. The focus may become blurry when recording subjects at the beach, in night views or in scenes involving fireworks or special lights.

Recording a subject in dark surroundings

The unit cannot focus correctly because the light information that comes through the lens decreases considerably.

Recording a fast-moving subject

As the focus lens-inside moves mechanically, it cannot keep up with a fast-moving subject. When, for example, recording a sports event with fast moving subjects, the focus may lose its sharpness.

Recording a subject with little contrast

It is easy to bring subjects with a sharp contrast or vertical lines or stripes into focus. This means that a subject with little contrast, such as a white wall, may become blurry because the unit achieves focus based upon the vertical lines of an image.

Specifications

High Definition Video Camera Information for your safety

Power source:	DC 9.3 V (When using AC adaptor) DC 7.2 V (When using battery)
Power consumption:	Recording: 5.8 W

Signal system	1080/60i
Recording format	AVCHD format compliant
Image sensor	1/6" 3CCD image sensor Total: 560 K×3 Effective pixels: Motion picture: 520 K×3 Still picture: 520 K×3
Lens	Auto Iris, F1.8 to F2.8 Focal length: 3.0 mm to 30.0 mm Macro (Full range AF)
Filter diameter	37 mm
Zoom	10× optical zoom, 25×/700× digital zoom
Monitor	2.7" wide LCD monitor (approx. 300 K pixels)
Microphone	5.1 channel surround microphone (with a zoom microphone/focus microphone function)
Speaker	1 round speaker Ø 20 mm
White balance adjustment	Auto tracking white balance system
Standard illumination	1,400 lx
Minimum required illumination	Approx. 5 lx (1/30 in Low light mode) Approx. 1 lx with the MagicPix function
A/V terminal video output level	1.0 Vp-p, 75 Ω, NTSC system
Component terminal video output level	Y: 1.0 Vp-p, 75 Ω Pb: 0.7 Vp-p, 75 Ω Pr: 0.7 Vp-p, 75 Ω
HDMI mini connector video output level	HDMI™ (x.v.Color™) 1125i (1080i)/525p (480p)
A/V terminal audio output level (Line)	316 mV, 600 Ω, 2 ch
HDMI mini connector audio output level	5.1 ch (AC3)/2 ch (Linear PCM)

USB	Card reader/writer function (No copyright protection support) Hi-Speed USB (USB 2.0), USB terminal Type Mini AB PictBridge-compliant
Flash	Available range: Approx. 1.0 m to 2.5 m (3.3 feet to 8.2 feet)
Dimensions	65 mm (W)×67 mm (H)×126 mm (D) [2.56 " (W)×2.638 " (H)×4.96 " (D)] (excluding projecting parts)
Mass (Weight)	Approx. 275 g (Approx. 0.606 lbs.) [without battery (supplied) and an SD card (optional)]
Mass (Weight) in operation	Approx. 337 g (Approx. 0.743 lbs.) [with battery (supplied) and an SD card (optional)]
Operating temperature	0 °C to 40 °C (32 °F to 104 °F)
Operating humidity	10% to 80%
Battery operation time	See page 22

Motion pictures

Recording media	SD Memory Card: 1 GB, 2 GB (FAT12 and FAT16 system compliant) SDHC Memory Card: 4 GB, 8 GB, 16 GB (FAT32 system compliant)
Compression	MPEG-4 AVC/H.264
Recording mode and transfer rate	HA: Approx. 17 Mbps (VBR) HG: Approx. 13 Mbps (VBR) HX: Approx. 9 Mbps (VBR) HE: Approx. 6 Mbps (VBR) Refer to page 38 for the recordable time.
Picture size	HA/HG: 1920×1080/60i, 1920×1080/24p HX: 1920×1080/60i HE: 1440×1080/60i
Audio compression	Dolby Digital (Dolby AC3)/5.1 ch

Still pictures

Recording media	SD Memory Card: 8 MB, 16 MB, 32 MB, 64 MB, 128 MB, 256 MB, 512 MB, 1 GB, 2 GB (FAT12 and FAT16 system corresponding) SDHC Memory Card: 4 GB, 8 GB, 16 GB (FAT32 system corresponding)
Compression	JPEG (Design rule for Camera File system, based on Exif 2.2 standard), DPOF corresponding
Picture size	1920×1080 Refer to page 43 for the number of recordable pictures.

AC adaptor









Information for your safety

Power source:	AC 110 V to 240 V, 50/60 Hz
Power consumption:	19 W
DC output:	DC 9.3 V, 1.2 A (Unit operation) DC 8.4 V, 0.65 A (Battery charging)

Dimensions	92 mm (W)×33 mm (H)×61 mm (D) [3.6 " (W)×1.3 " (H)×2.4 " (D)]
Mass (Weight)	Approx. 115 g (Approx. 0.25 lbs.)

Specifications may change without prior notice.

Optional accessories

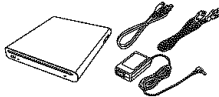
Accessory No.	Figure	Description
VW-AD21PP-K		AC adaptor with AC Cable and DC Cables
VW-VBG130*1		1320 mAh/Rechargeable Lithium Ion Battery Pack
VW-VBG260*1		2640 mAh/Rechargeable Lithium Ion Battery Pack
VW-VBG6*1*2		5800 mAh/Rechargeable Lithium Ion Battery Pack
VW-VH04		Battery pack holder kit
RP-CDHM15 RP-CDHM30		HDMI mini cable
VW-T3714H		Tele conversion lens
VW-W3707H		Wide conversion lens
RP-SDM04GU1K RP-SDM02GU1A		Class 4 4 GB SDHC Memory Card Class 4 2 GB SD Memory Card
RP-SDV16GU1K RP-SDV08GU1K RP-SDV08GU1A (USA only) RP-SDV04GU1K RP-SDV02GU1A RP-SDV01GU1A		Class 6 16 GB SDHC Memory Card Class 6 8 GB SDHC Memory Card Class 6 4 GB SDHC Memory Card Class 6 2 GB SD Memory Card Class 6 1 GB SD Memory Card
VW-BN1		DVD burner

*1 Please refer to page 22, concerning the battery charging time and available recording time.

*2 The battery pack holder kit VW-VH04 (optional) is necessary.

NOTE:

Accessories and/or model numbers may vary by country. Please consult your local dealer.

Accessory Order Form (For USA Customers)

Please photocopy this form when placing an order.

1. Model # _____

2. Items Ordered

Accessory #	Description	Price Each	Quantity	Total Price
Subtotal				
Your State & Local Sales Tax				
Shipping & Handling				6.95
Total Enclosed				

3. Method of payment (check one)

- Check of Money Order enclosed (NO C.O.D.SHIPMENTS)
- VISA Credit Card # _____
- MasterCard Expiration Date _____
- Discover Customer Signature _____

Make Check or Money Order Payable to: PANASONIC ACCESSORIES

(Please do not send cash)

4. Shipping information (UPS delivery requires complete street address)

Ship To:

Mr.

Mrs.

Ms. _____

First Last

Phone#:

Day () _____

Street Address _____

Night () _____

City State Zip

TO OBTAIN ANY OF OUR ACCESSORIES YOU CAN DO ANY OF
THE FOLLOWING:
VISIT YOUR LOCAL PANASONIC DEALER
OR
CALL PANASONIC'S ACCESSORY ORDER LINE AT 1-800-332-5368
[6 AM-6 PM M-F, PACIFIC TIME]
OR

MAIL THIS ORDER TO: PANASONIC SERVICE AND TECHNOLOGY COMPANY ACCESSORY ORDER OFFICE
20421 84th Avenue South Kent, WA. 98032

In CANADA, please contact your local Panasonic dealer for more information on Accessories.



Request for Service Notice (USA Only)

Please photocopy this form when making a request for service notice, in the unlikely event this product needs service.

Request for Service Notice:

- Please include your **proof of purchase**.
(Failure to do so will delay your repair.)
- To further speed your repair, please provide an explanation of what is wrong with the unit and any symptom it is exhibiting.

Mail this completed form and your Proof of Purchase along with your unit to:
Panasonic Camera and Digital Service Center
1590 Touhy Ave.
Elk Grove Village, IL 60007



Limited Warranty (For USA Customers)

PANASONIC CONSUMER ELECTRONICS
COMPANY, DIVISION OF PANASONIC
CORPORATION OF NORTH AMERICA
One Panasonic Way, Secaucus, New Jersey 07094

PANASONIC PUERTO RICO, INC.
Ave. 65 de Infantería, Km. 9.5 San Gabriel Industrial Park,
Carolina, Puerto Rico 00985

Panasonic Video Products Limited Warranty

Limited Warranty Coverage

If your product does not work properly because of a defect in materials or workmanship, Panasonic Consumer Electronics Company or Panasonic Puerto Rico, Inc. (collectively referred to as "the warrantor") will, for the length of the period indicated on the chart below, which starts with the date of original purchase ("warranty period"), at its option either (a) repair your product with new or refurbished parts, or (b) replace it with a new or a refurbished product. The decision to repair or replace will be made by the warrantor.

Product	Parts	Labor	Service	Contact Number
Camcorder	One (1) Year (except CCD Image Sensor) CCD Image Sensor - 6 (Six) Months	Ninety (90) Days Ninety (90) Days	Carry-In or Mail-In	1-800-211-PANA(7262)
DVD/VCR Deck, A/V Mixer	One (1) Year	Ninety (90) Days	Carry-In or Mail-In	1-800-211-PANA(7262)
TV/VCR, TV/DVD, TV/DVD/VCR Combination	One (1) Year (except CRT) CRT - Two (2) Years	Ninety (90) Days Ninety (90) Days	Carry-In: 21" CRT and Smaller In-Home or Carry-In: 22" CRT and Larger	1-800-211-PANA(7262)
TV/HDR Combination	One (1) Year (except CRT) CRT - Two (2) Years	Ninety (90) Days Ninety (90) Days	In-Home or Carry-In	1-888-843-9788
Rechargeable Batteries (in exchange for defective item)	Ten (10) Days	Not Applicable	Carry-In or Mail-In	1-800-211-PANA(7262)
Tape (in exchange for defective item)	Five (5) Days	Not Applicable	Carry-In or Mail-In	1-800-211-PANA(7262)
Memory Cards (in exchange for defective item)	Ninety (90) Days	Not Applicable	Carry-In or Mail-In	1-800-211-PANA(7262)

During the "Labor" warranty period there will be no charge for labor. During the "Parts" warranty period, there will be no charge for parts. You must carry-in or mail-in (prepaid) your product or arrange for in-home service, as applicable, during the warranty period. If non-rechargeable batteries are included, they are not warranted. This warranty only applies to products purchased and serviced in the United States or Puerto Rico. This warranty is extended only to the original purchaser of a new product which was not sold "as is". A purchase receipt or other proof of the original purchase date is required for warranty service.

Carry-In, Mail-in (Prepaid) or In-Home Service

For Carry-In, Mail-In (prepaid) or In-Home Service (as applicable) in the United States call toll free contact number listed above or visit Panasonic Web Site: <http://www.panasonic.com>

For assistance in Puerto Rico call Panasonic Puerto Rico, Inc. (787)-750-4300 or fax (787)-768-2910.

In-Home service, if applicable, requires clear, complete and easy access to the product by the authorized servicer and does not include removal or re-installation of an installed product. It is possible that certain in-home repairs will not be completed in-home, but will require that the product, or parts of the product, be removed for shop diagnosis and/or repair and then returned.

Limited Warranty Limits And Exclusions

This warranty ONLY COVERS failures due to defects in materials or workmanship, and DOES NOT COVER normal wear and tear or cosmetic damage, nor does it cover markings or retained images on the picture tube resulting from viewing fixed images (including, among other things, letterbox pictures on standard 4:3 screen TV's, or non-expanded standard 4:3 pictures on wide screen TV's, or onscreen data in a stationary and fixed location). The warranty ALSO DOES NOT COVER damages which occurred in shipment, or failures which are caused by products not supplied by the warrantor, or failures which result from accidents, misuse, abuse, neglect, bug infestation, mishandling, misapplication, alteration, faulty installation, set-up adjustments, misadjustment of consumer controls, improper maintenance, power line surge, lightning damage, modification, or commercial use (such as in a hotel, office, restaurant, or other business), rental use of the product, service by anyone other than a Factory Service Center or other Authorized Servicer, or damage that is attributable to acts of God.

THERE ARE NO EXPRESS WARRANTIES EXCEPT AS LISTED UNDER "LIMITED WARRANTY COVERAGE". THE WARRANTOR IS NOT LIABLE FOR INCIDENTAL OR CONSEQUENTIAL DAMAGES RESULTING FROM THE USE OF THIS PRODUCT, OR ARISING OUT OF ANY BREACH OF THIS WARRANTY.

(As examples, this excludes damages for lost time, cost of having someone remove or re-install an installed unit if applicable, or travel to and from the servicer, loss of media or images, data or other memory or recorded content. The items listed are not exclusive, but are for illustration only.)

ALL EXPRESS AND IMPLIED WARRANTIES, INCLUDING THE WARRANTY OF MERCHANTABILITY, ARE LIMITED TO THE PERIOD OF THE LIMITED WARRANTY.

Some states do not allow the exclusion or limitation of incidental or consequential damages, or limitations on how long an implied warranty lasts, so the exclusions may not apply to you. This warranty gives you specific legal rights and you may also have other rights which vary from state to state. If a problem with this product develops during or after the warranty period, you may contact your dealer or Service Center. If the problem is not handled to your satisfaction, then write to the warrantor's Consumer Affairs Department at the addresses listed for the warrantor.

PARTS AND SERVICE (INCLUDING COST OF AN IN-HOME SERVICE CALL, WHERE APPLICABLE) WHICH ARE NOT COVERED BY THIS LIMITED WARRANTY ARE YOUR RESPONSIBILITY.

Customer Services Directory

Service in Canada: As per Servicentre listed in Canadian warranty information on page 137.

Obtain Product Information and Operating Assistance; locate your nearest Dealer or Service Center; purchase Parts and Accessories; or make Customer Service and Literature requests by visiting our Web Site at:

<http://www.panasonic.com/consumersupport>

or, contact us via the web at:

<http://www.panasonic.com/contactinfo>

You may also contact us directly at:

1-800-211-PANA (7262),

Monday-Friday 9 am-9 pm; Saturday-Sunday 10 am-7 pm, EST

For hearing or speech impaired TTY users, TTY : 1-877-833-8855

Accessory Purchases

Purchase Parts, Accessories and Instruction Books online for all Panasonic Products by visiting our Web Site at:

<http://www.pstc.panasonic.com>

or, send your request by E-mail to:

npcparts@us.panasonic.com

You may also contact us directly at:

1-800-332-5368 (Phone) 1-800-237-9080 (Fax Only) (Monday – Friday 9 am to 9 pm, EST.)

Panasonic Service and Technology Company

20421 84th Avenue South,

Kent, WA 98032

(We Accept Visa, MasterCard, Discover Card, American Express, and Personal Checks)

For hearing or speech impaired TTY users, TTY : 1-866-605-1277

Product Repairs

Centralized Factory Service Center

MAIL TO:

Panasonic Camera and Digital Service Center

1590 Touhy Ave.

Elk Grove Village, IL 60007

Please carefully pack and ship, prepaid and insured, to the Elk Grove Village Centralized Factory Service Center.

Customer's in Puerto Rico, please ship or carry in to location below ("Service in Puerto Rico").

Service in Puerto Rico

Panasonic Puerto Rico, Inc.

Ave. 65 de Infantería, Km. 9.5, San Gabriel Industrial Park,

Carolina, Puerto Rico 00985

Phone (787)750-4300, Fax (787)768-2910

As of January 2007

Warranty (For Canadian Customers)

Panasonic Canada Inc.

5770 Ambler Drive, Mississauga, Ontario L4W 2T3

PANASONIC PRODUCT – LIMITED WARRANTY

Panasonic Canada Inc. warrants this product to be free from defects in material and workmanship and agrees to remedy any such defect for a period as stated below from the date of original purchase.

Camcorder Product – One (1) year, parts and labour

LIMITATIONS AND EXCLUSIONS

This warranty does not apply to products purchased outside Canada or to any product which has been improperly installed, subjected to usage for which the product was not designed, misused or abused, damaged during shipping, or which has been altered or repaired in any way that affects the reliability or detracts from the performance, nor does it cover any product which is used commercially. Dry cell batteries are also excluded from coverage under this warranty.

This warranty is extended to the original end user purchaser only. A purchase receipt or other proof of date of original purchase is required before warranty service is performed.

THIS EXPRESS, LIMITED WARRANTY IS IN LIEU OF ALL OTHER WARRANTIES, EXPRESS OR IMPLIED, INCLUDING ANY IMPLIED WARRANTIES OF MERCHANTABILITY AND FITNESS FOR A PARTICULAR PURPOSE.

IN NO EVENT WILL PANASONIC CANADA INC. BE LIABLE FOR ANY SPECIAL, INDIRECT OR CONSEQUENTIAL DAMAGES.

In certain instances, some jurisdictions do not allow the exclusion or limitation of incidental or consequential damages, or the exclusion of implied warranties, so the above limitations and exclusions may not be applicable.

WARRANTY SERVICE

FOR PRODUCT OPERATION ASSISTANCE, please contact:

Our Customer Care Centre:	Telephone #:	(905) 624-5505
	1-800 #:	1-800-561-5505
	Fax #:	(905) 238-2360
	Email link:	“Customer support” on www.panasonic.ca

FOR PRODUCT REPAIRS, please locate your nearest Authorized Servicentre at www.panasonic.ca :

Link: “Servicentres™ locator” under “Customer support”

IF YOU SHIP THE PRODUCT TO A SERVICENTRE

Carefully pack and send prepaid, adequately insured and preferably in the original carton. Include details of the defect claimed, and proof of date of original purchase.

Index

■ Numerics

24p digital cinema	51
5.1 channel	82

■ A

A/V terminal	17, 78, 92
AC adaptor	20, 23, 125
Aperture	62
Auto focus	127
Auto Ground-Directional Standby (AGS)	35
Auto mode	35
Auto slow shutter	57
Automatic white balance	127
AVCHD	11

■ B

Backlight compensation	49
Battery	20, 125
Battery capacity indication	22
Beep sound	29

■ C

Card	24, 25
Charging time	22
Color bar	56
Component terminal	17, 82
Copy	
Disc	87

Cursor button	16
Customer Services Directory	136

■ D

Date and time display	30
Date and time setting	30
Delete	72
Demo mode	29
Digital cinema color	57
Digital zoom	44
Display	28
Dividing a scene to delete	74
DPOF setting	76
Dubbing	92
DVD burner	86
Copying to discs	87
Managing the copied disc	91
Playing back the copied disc	90

■ F

Face detection & AE mode	46
Fade	48
Flash	55
Focus	60
Focus microphone	52
Format	77
Frame-by-frame playback	66

■ G

Gain	62
Grip belt	18
Guide line	51

■ H

HD hi-speed burst shooting mode	54
HDMI mini connector	17, 81, 83
Help mode	48
High definition	11

■ I

Image stabilizer	45
Initial setting	29
Intelligent contrast control	48
Intelligent scene selection	67
Iris	62

■ L

Language	28
LCD monitor	16, 32, 126
Lens hood	17
Limited Warranty (Canada)	137
Limited Warranty (USA)	135
Low light	49

■ M

MagicPix function	49
Manual focus	60
Menu	27
Menu list	28
MF assist	60
Microphone level	53
Microphone setup	52
Mode switch	26
Motion picture	
Playback	64
Recording	36
Motion picture compatibility	66

■ N

Number of recordable pictures	43
-------------------------------	----

■ O

Operation icons	47
-----------------	----

■ P

PictBridge	93
Picture quality	43
Playing back motion pictures by date	67
Playing back still pictures by date	71
POWER LCD EXTRA	32
Power save	28
PRE-REC	40
Protect	
Scenes	75
Still pictures	75

■ Q

Quick start	39
-------------	----

■ R

Recordable time	22, 38
Recording lamp	28
Recording modes	38
Recording time elapsed	37
Red eye reduction	55
Remaining number of still pictures	42
Remaining time left for recording	37
Remote control	19
Repair	112
Repeat playback	68
Request for Service Notice (USA Only)	134
Resume playback	68

■ S

Scene mode	59
SD Memory Card	24
SD Speed Class Rating	24
SDHC Memory Card	24
Self-recording	32
Self-timer recording	49
Shooting guide	40
Shoulder strap fixture	18
Shutter sound	56
Shutter speed	62
Skip playback	65
Slide show	14, 70
Slow-motion playback	66
Soft skin mode	49
Still picture	
Playback	69
Recording	41
Still picture compatibility	70
Surround microphone	52

■ T

Tele macro	49
Tripod receptacle	17
TV aspect	80

■ V

VIERA Link	83
Volume adjustment	65

■ W

White balance	61, 127
Wind noise reduction function	52
World time setting	31

■ Z

Zebra	56
Zoom	44
Zoom microphone	52

Spanish Quick Use Guide/Guía española para el uso rápido

■ Carga de la batería

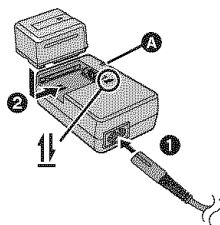

Luz indicadora de carga
[CHARGE] **A**

Encendida:
Carga en curso
Apagada:
Carga completada

- 1 Conecte el cable de CA al adaptador de CA y a la toma de CA.
- 2 Instale la batería en el compartimento alineando la marca y, a continuación, conéctela de forma segura.

■ Inserción de la batería

Abra el monitor LCD e instale la batería insertándola en la dirección mostrada en la figura.

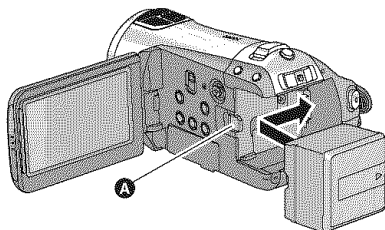

- A** Inserte la batería hasta que dispare y se bloquee.

■ Cómo encender la unidad

Encienda la alimentación girando el interruptor del modo a o mientras pulsa el botón de desbloqueo **A**.

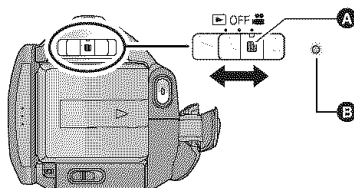

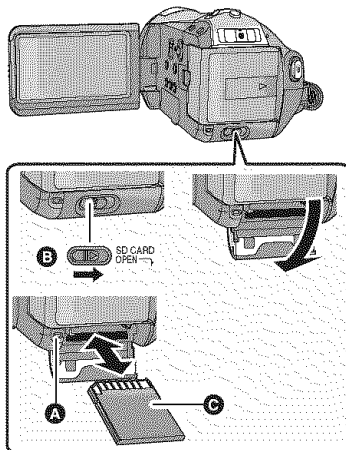

- Actúe en el interruptor del modo mientras pulsa al mismo tiempo el botón de desbloqueo si cambia de OFF a otro modo.
- Indicador de estado **B**
- Para apagar la unidad, ajuste el interruptor del modo a OFF.

■ Insertar/extraer una tarjeta SD



Luz indicadora de acceso a la tarjeta [ACCESS]

- Cuando esta unidad accede a la tarjeta SD, **A** la luz indicadora de acceso se enciende.

- 1 **Ajuste el interruptor del modo a OFF.**
- 2 **Abra la tapa de la tarjeta SD mientras desplaza la palanca SD CARD OPEN .**
- 3 **Inserte/extraiga la tarjeta SD.**
 - Coloque el lado del terminal  en la dirección mostrada en la figura y empujelo hasta que tope manteniéndolo derecho.
 - Para extraer la tarjeta SD, presione en el centro de la tarjeta SD y luego tire de ella derecho hacia fuera.
- 4 **Cierre firmemente la tapa de la tarjeta SD.**
 - Ciérrela firmemente hasta que dispare.

■ Selección del idioma

- 1) Pulse el botón MENU, seleccione [LANGUAGE] y, luego, pulse el botón cursor.
- 2) Seleccione [Español] y pulse el botón cursor.

■ Modo de ayuda

En el modo de ayuda se describen los iconos de funcionamiento que aparecen cuando se ajusta el interruptor AUTO/MANUAL/FOCUS a la posición AUTO en el modo de grabación.

- Actúe en el interruptor del modo para seleccionar .
- 1) Pulse el cursor para visualizar el icono.



- 2) Mueva el cursor hacia la derecha para seleccionar [].



- 3) Mueva el cursor hacia arriba, hacia izquierda o hacia la derecha para seleccionar el icono deseado.



- En la parte inferior de la pantalla se visualiza la explicación del icono seleccionado.
- Cada vez que mueva el cursor hacia abajo, la indicación cambiará.
- Cuando se utiliza el modo de ayuda, no es posible seleccionar funciones.

Para salir del modo de ayuda



Pulse el botón MENU o seleccione [END].

■ Grabación de películas

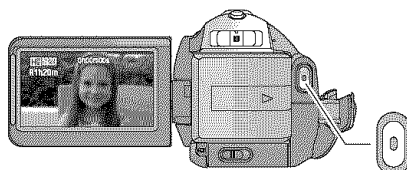
- 1) Actúe en el interruptor del modo para seleccionar  y abra el monitor LCD.
- 2) Pulse el botón de inicio/parada de grabación para iniciar la grabación.



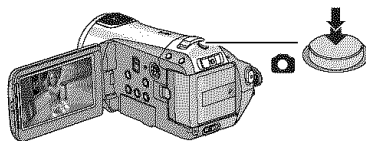

■ Grabación de fotografías

- 1) Actúe en el interruptor del modo para seleccionar  y abra el monitor LCD.
- 2) Pulse el botón  a tope.



■ Reproducción de películas

- 1) Actúe en el interruptor del modo para seleccionar  .
- 2) Seleccione [] (reproducción de películas)  usando el botón cursor.

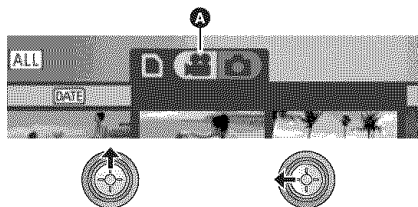





- 3) Seleccione la escena a ser reproducida, luego pulse el botón cursor.

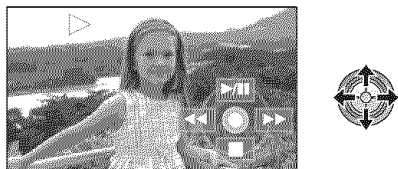



- 4) Seleccione la operación de reproducción con el botón cursor.



- : Reproducción/Pausa
- : Rebobinado durante la reproducción
- : Avance rápido durante la reproducción
- : Detener la reproducción y visualizar las miniaturas.

■ Reproducción de fotografías

- 1) Actúe en el interruptor del modo para seleccionar  .
- 2) Seleccione [] (reproducción de fotografías)  usando el botón cursor.

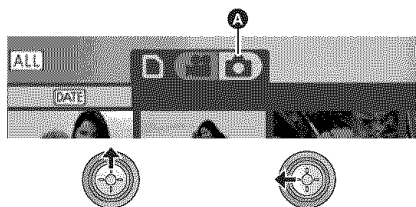





- 3) Seleccione la fotografía a ser reproducida y pulse el botón cursor.

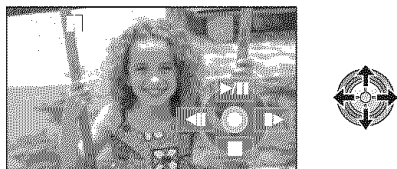

- 4) Seleccione la operación de reproducción con el botón cursor.



- : Iniciar o hacer una pausa en la presentación de diapositivas (reproducción de las fotografías contenidas en orden numérico).
- : Reproducir la imagen anterior.
- : Reproducir la imagen siguiente.
- : Detener la reproducción y visualizar las miniaturas.

**Panasonic Consumer Electronics Company,
Division of Panasonic Corporation of North America**

One Panasonic Way, Secaucus, NJ 07094

Panasonic Puerto Rico, Inc.

Ave. 65 de Infantería, Km. 9.5, San Gabriel Industrial Park, Carolina, Puerto Rico 00985

Panasonic Canada Inc.

5770 Ambler Drive, Mississauga, Ontario, L4W 2T3



VQT1N45
S0108MK0



© 2008 Matsushita Electric Industrial Co., Ltd.