

KYY K3-1

User Guide

15.6" Full HD Portable Monitor



Note: Any technical problem pls contact support team

[\[support@kyytech.com\]](mailto:support@kyytech.com)

Service

**Not Satisfied?
Monitor Damaged?
Can't Connect?**

We apologize for any inconveniences,
if the monitor you received damaged or can't connect
the monitor successfully with your devices,

Please Contact:

 support@kyytech.com



KYY provides

12-MONTH WARRANTY

plus online responsive customer service

Content

Package List	1
Introduction	2
Smart Cover	4
Connect with Devices	6
Mode Settings	11
Supported Devices and Models	17
Specifications	19
Notices	20
Troubleshooting	21

Package List



15.6" Portable Monitor

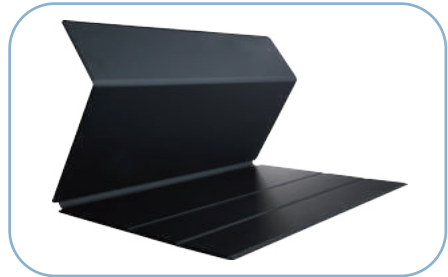

Magnetic Smart Cover



USB-C to
USB-C Cable



Mini HDMI to
HDMI Cable



USB-C to USB-A
Cable (Power Supply)



5V/2.4 A Power
Adapter

Introduction



- 1 Dual Speakers**
Listen to music, movies, games, and multimedia files.
- 2 Power Button/Back Button**
Long press for 3s to turn the screen on/off. Short press to back to the previous page.
- Trackwheel**
 - Press the trackwheel to turn to the OSD menu. Scroll the trackwheel to control the cursor on the menu, and press to confirm;
 - In the main interface, scroll up to open the adjust shortcut menu.
- 4 3.5mm Audio Output**
Headsets, speakers or digital audio equipment extension interface.

Introduction

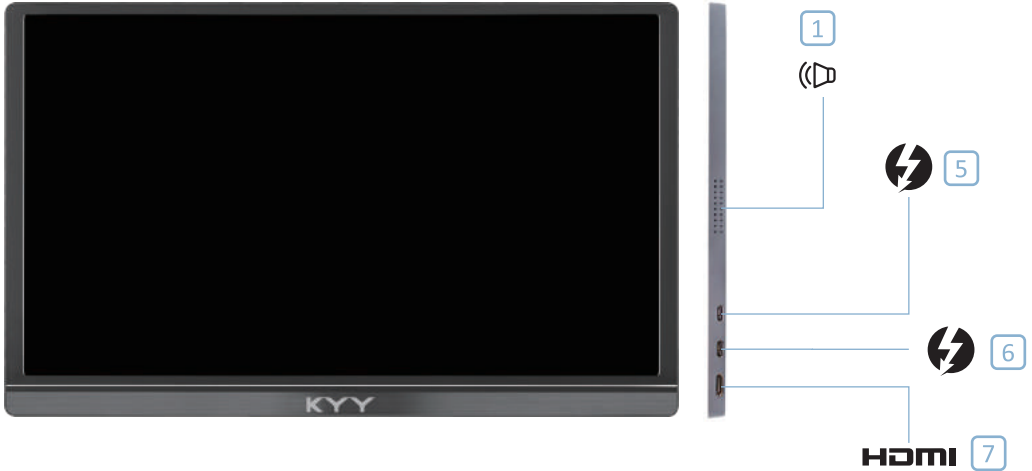

5

Type-C Full Function Port

- Supply power(5~20V voltage input);
- Transmit the audio, video signal.

6

Type-C Full Function Port

- Supply power(5~20V voltage input);
- Transmit the audio, video signal.

7

Mini HDMI Port

- Audio and video signal transmission.

Smart Cover

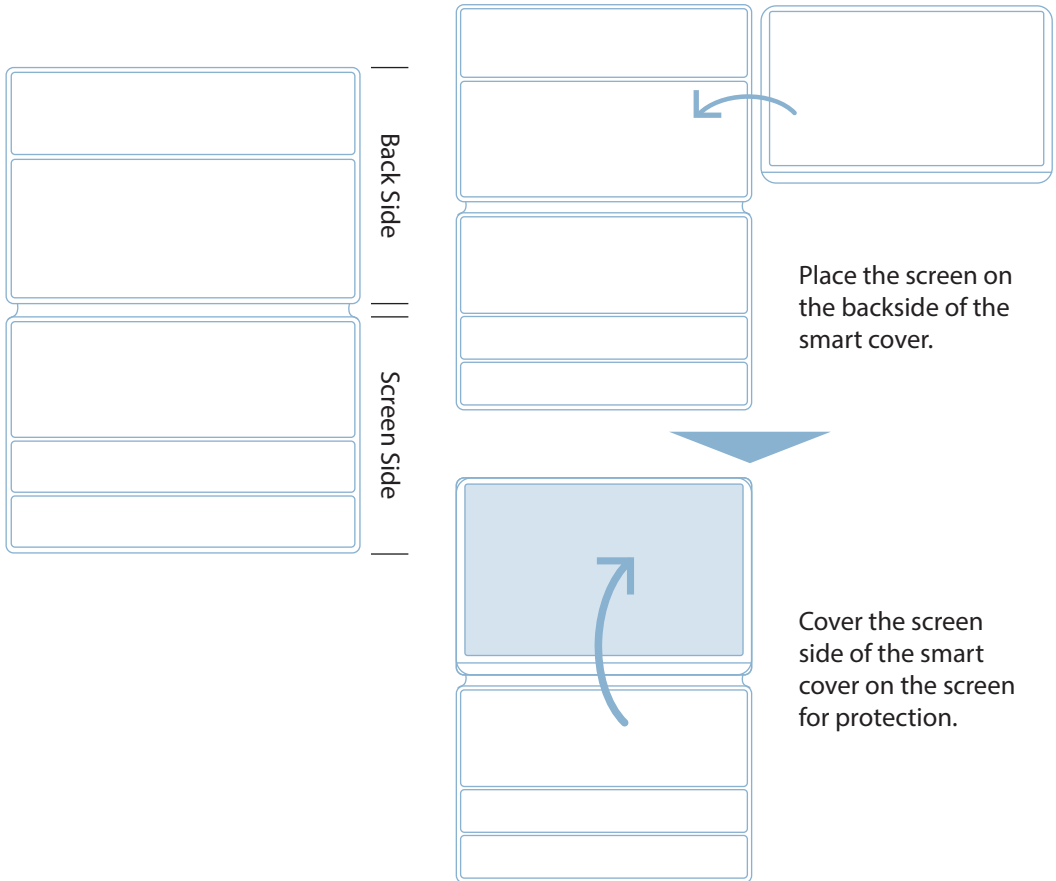

Smart Cover

Use the smart cover to make the monitor stands at a proper viewing angle.

Fold the screen side of the smart cover back to support the screen's bottom.

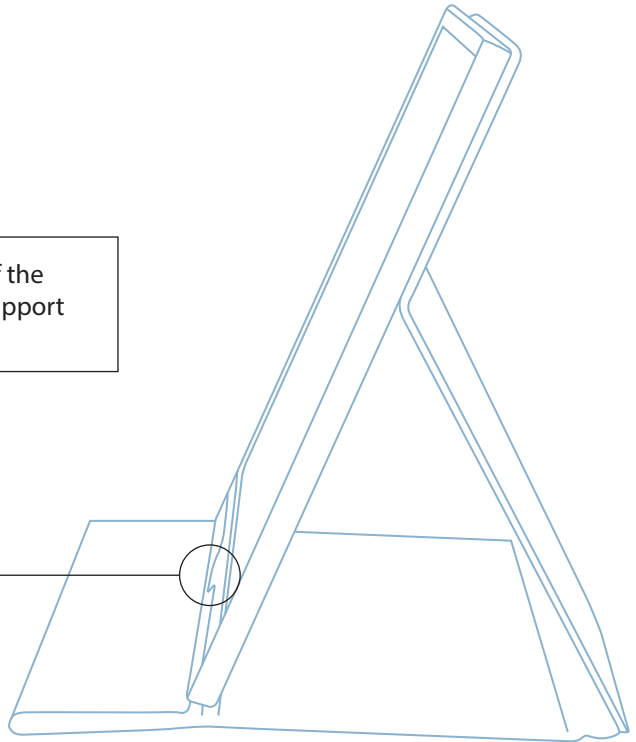

Connect with Devices

1 Connect with External Power Supply

Connect your monitor to the power supply with the [usb-c to usb-a cable] and the Adapter provided, plug in the [usb-c to usb-c cable] OR [mini HDMI to HDMI cable] for video output.

2 Connect without External Power Supply

Only works with full-function USB-C port. Please plug in the [usb-c to usb-c cable] to the USB-C full-function port and make sure the USB-C port of your device is full-function.

Note: The monitor does not have an internal battery. Before using, please make sure the connected devices or power adapter can supply at least 5V/2.4A power.

Connect with Devices

USB-C Laptop

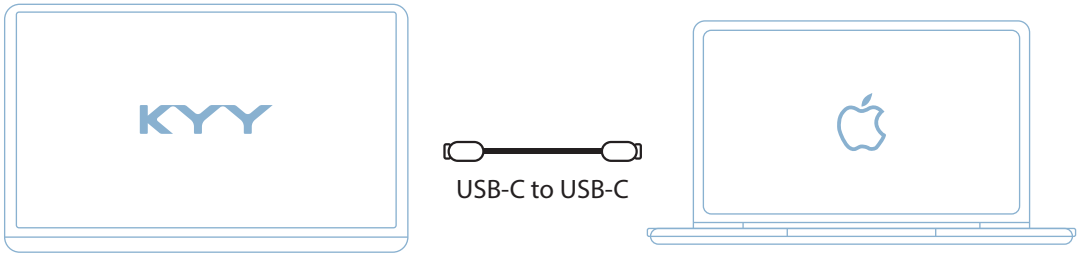

External Power Supply Needed Conditions

1. Brightness or volume is greater than 80%.
2. The type-c cable does not have a power supply function.

Note: Please check if the USB-C port of your laptop is compatible with audio and video signal transmission. If not, it would need a corresponding adapter to connect.

Connect with Devices

USB-C Phone

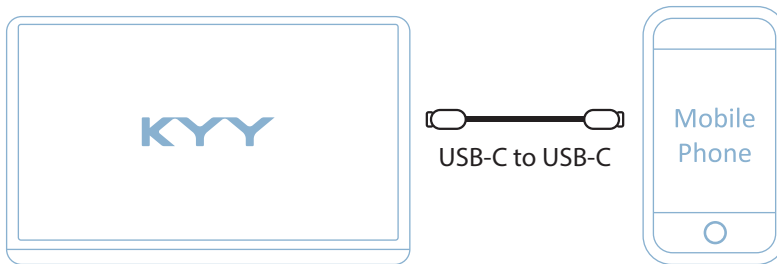

- 1 If there is no external power supply, the phone would supply power to the monitor. Then the monitor would turn to energy-saving mode (30% brightness).
- 2 If plugin a 5V/2.4A (or above) external power, the monitor can reversely charge the phone.

Note: Only works with phones with full-function USB-c port.
(for iPhone needs a Lightning to HDMI Adapter.)

Connect with Devices

HDMI PC/Laptop

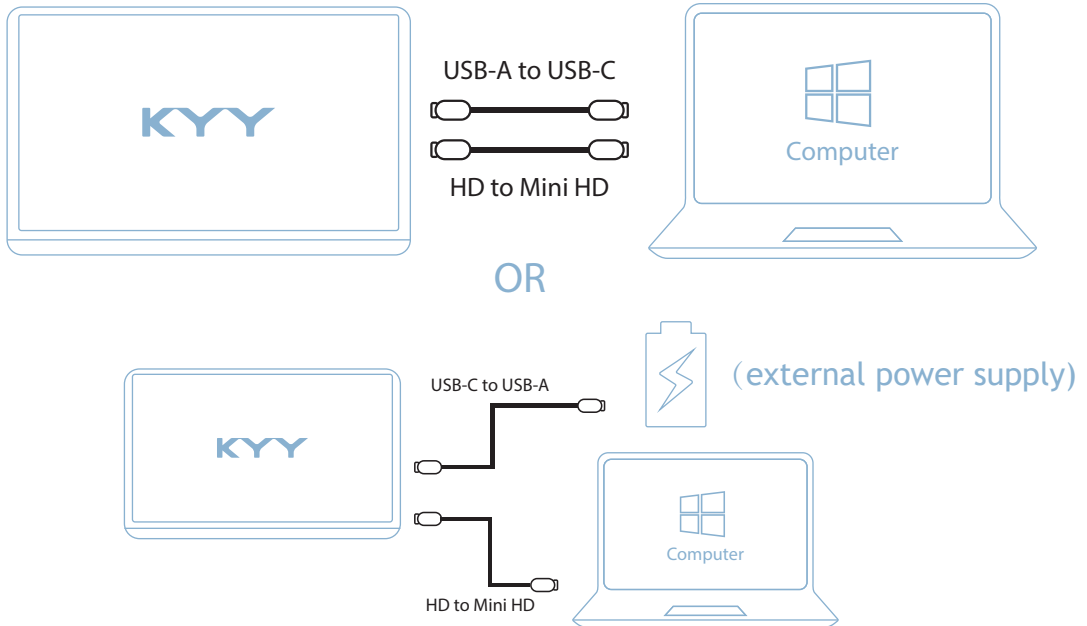

Note: HDMI port does not supply power. The monitor needs an external power supply (5V/2.4A or above) or USB-A to USB-C cable to supply.

Connect with Devices



HDMI Other Devices

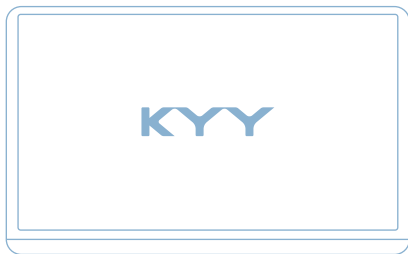

USB-A to USB-C



HD to Mini HD

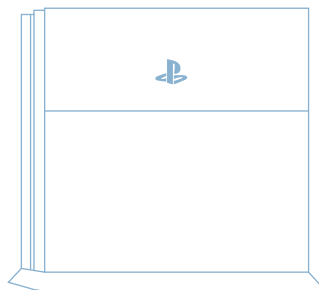

OR



USB-C to USB-A

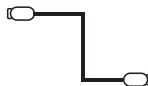

HD to Mini HD



(external power supply)

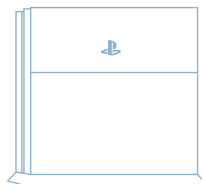

Note: Please connect the external power supply first then the mini HDMI to HDMI cable to ensure smooth transmission.

Mode Settings

Multiple-Display Setting for Windows

- 1 Right-click the desktop and select either Screen Resolution (Windows 7/8) or Display Settings (Windows 10)
- 2 **Screen Rotate Setting:** Click the Orientation drop-down list, and then select Landscape or Portrait.

- 3 **Duplicate & Extend Mode Setting:** Click the Multiple displays drop-down list, and then select Extend/Duplicate these displays.
Note: If you cannot see the additional monitor listed, click Detect.
If does not work, try restarting your computer and do steps again.

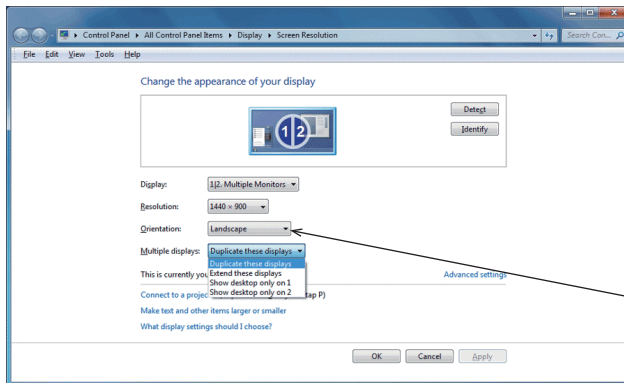

Note: If you cannot find the Orientation option, please check if your laptop/PC has this function.

Mode Settings

Multiple-Display Setting for Mac

- 1 Choose Apple menu > System Preferences, then click Displays.
- 2 Click the Arrangement tab.
- 3 To change the position of a display, drag it to the desired position. A red border appears around the display as it's movable.

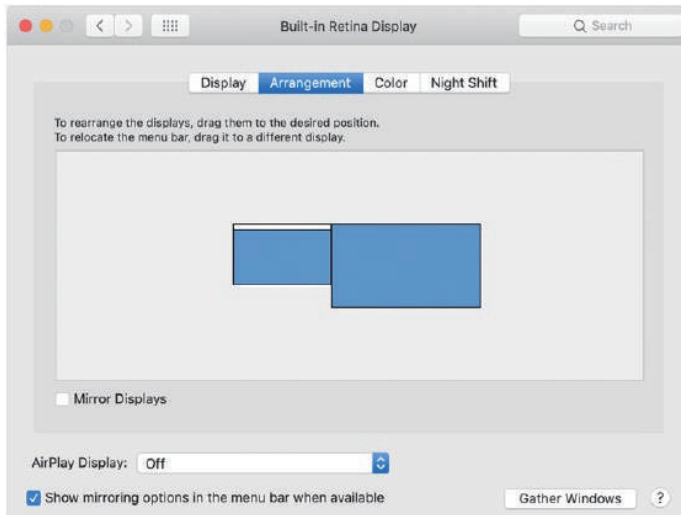

Mode Settings

OSD (On Screen Display) Menu



- 1 Press the trackwheel to turn on the OSD menu.
- 2 Scroll the trackwheel to control the cursor on the menu.
- 3 Press the trackwheel to confirm.
- 4 Short press the back button to back to the upper page.

Mode Settings

OSD (On Screen Display) Menu

BRIGHTNESS	BRIGHTNESS	Adjust the brightness of display.
	CONTRAST	Adjust the difference in color and light between parts of an image.
	BLACK LEVEL	Adjust the level of brightness at the darkest part of a visual image.
	SHARPNESS	Adjust the sharpness of graphics.
IMAGE	ECO	Adjust the applicable scene: such as TEXT mode, increase the contrast and reduce the brightness to protect the eyes.
	DCR	Dynamic Contrast Ratio. Adjust the brightness according to the display to better display the color contrast.
	ASPECT	Adjust the proportional relationship between the width and height of the display. Such as 4:3.

Mode Settings

OSD (On Screen Display) Menu

COLOR TEMP.	COLOR TEMP.	Adjust the screen color temperature.
	RED	Adjust the brightness of the RGB colors.
	GREEN	
	BLUE	
OSD SETTING	LANGUAGE	Modify the OSD Menu interface language, default is English. OSD TIMER
	OSD TIMER	Adjust the time th OSD Menu display remains on the screen.
	TRANSPARENCY	Adjust the transparency of the OSD menu.

Mode Settings

OSD (On Screen Display) Menu

RESET	RESET	Reset all the items to factory defaults.
	MUTE	Mute the display.
	VOLUME	Adjust the display volume.
MISC	SIGNAL SOURCE	Switch signal sources such as HDMI or Type-C.
	LOW BLUE LIGHT	Filters out harmful blue light, which can cause eye fatigue.
	HDR MODE	Enables the monitor to display a wider range of colors and contrast.

Supported Devices and Models

Phone

Brand	Model
SAMSUNG	DEX, S8/S9/S10/S20 Series, Note 8/Note 9/Note 10 Series
HUAWEI	Mate 10/Mate 20/Mate 30 Series, Mate RS, P20/P30/P40 Series
HONOR	Note 10, V20/V30 Series
OPPO	R17 Pro, Reno, Find
Razer	Razer Phone, Razer Phone 2
HTC	U Ultra
LG	G5, G6, G7
ASUS	ROG Gaming Phone
More Brands	Updating

Supported Devices and Models

Laptop

Brand	Model
Apple	MacBook 12 in, MacBook Pro 2016/2017/2018 MacBook Air 2018, iPad Pro 2018
Google	Chromebook Pixels, Pixelbook Pen
Lenovo	Savior Y7000, Savior Y7000P, Savior Y9000K, YOGA 6 Pro, ThinkPad X1 Carbon, Yoga 5 Pro, Miix 720
DELL	G3 Series, G5 Series, G7 Series, Inspiron 5000, Inspiron 7000, XPS13, XPS15
HP	EliteBook 1050G1, EliteBook Folio G1, Omen 4 Pro, Pavilion X2
Microsoft	Surface Book 2
ASUS	Lingyao 3, U306, U321 Series, U4100, ROG Series
HUAWEI	MateBook D,
Razer	Blade Stealth
More Brands	Updating

Specifications

Product: KYE K3-1 Portable Monitor

Visible Area: 344.16*194.59mm

Panel Type: IPS LCD

Contrast Ratio: 1000: 1

Resolution: 1920*1080

Color Temperature: 6800K

Brightness: 300cd/m²

Aspect Ratio: 16:9

Display Color: 16.7M

Speaker: Built-in Speaker (1W*2)

Visual Angle: H 85°/85°Min V 85°/85°Min

Product Dimensions: 368*225*9.0mm

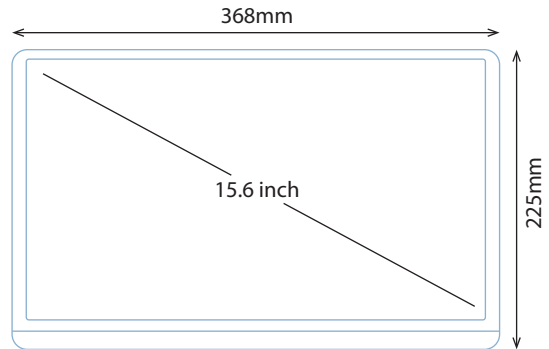

Output Interface: 3.5mm Headphone Interface

Input Interface: Mini HD (Video signal), Dual Type-C Full Function (Video data, Power supply).

System Requirement: Devices with HD output interface.

Computers or mobile phones with Type-C Fully Functional port.

Notices

- Before setting up the monitor, carefully read all the instructions with the package.
- To prevent fire or shock hazards never expose the monitor to rain or moisture.
- Never attempt to open the monitor cabinet.
- Before using, make sure all the cables are correctly connected and power cable is not damaged.
- Avoid dust, humidity, and temperature extremes. Do not place in any area where it may be wet.
- Place the monitor on a stable surface.
- Never push objects or spill liquid of any kind into the slots on the monitor cabinet.

Troubleshooting

Problem	Possible Solution
Power LED is not ON.	<ul style="list-style-type: none">• Press the power button to check if the monitor is in the ON mode.• Check if the USB cable is properly connected to the monitor and the power outlet.
Can't connect	<ul style="list-style-type: none">• Check if the monitor and the computer are in the "ON" mode.• Make sure the cable is properly connected between the KYE monitor and the computer.• Please make sure that the monitor has been charged by the connected device or by the included 5V/2.4A power adapter.• Inspect the signal cable and make sure none of the pins are bent.• Connect the monitor with other available devices to check.• (Note: The monitor doesn't have an internal battery, and the HDMI port does not supply power.• If still can't connect, pls contact [support@kyetech.com] to consult.
Screen image is too light or dark.	<ul style="list-style-type: none">• Adjust the Brightness settings via OSD.

Problem	Possible Solution
The screen flickers in various colors when starting up.	<ul style="list-style-type: none"> • Long press the power button for 3s to turn off the monitor and restart it again.
Brightness/Volume shows grey and can't be adjusted.	<ul style="list-style-type: none"> • Please make sure that HDR mode is turned off and Scene(ECO) Mode is not adjusted (Stay"Standard Mode").
Screen image bounces or a wave pattern is present in the image.	<ul style="list-style-type: none"> • Make sure the USB cable is properly connected between the USB monitor and the computer. • Move electrical devices that may cause electrical interference.
Screen image has color defects.	<ul style="list-style-type: none"> • Inspect the USB cable and make sure that none of the pins are bent.

Contact Us

**If you encounter any technical problem,
Please Contact:**



support@kyytech.com



KYY provides

12-MONTH WARRANTY

plus online responsive customer service