

**MODEL
GGSHPD88W**

V1.1 0925



ESSENTIALS FOR LIFE

User Manual

**8kg Heat Pump
Clothes Dryer**

SÔLT

Welcome

Residentia Group

—

Head Office
165 Barkly Avenue
Burnley Victoria
Australia 3121

—

ACN

600 546 656

—

Online

residentia.group
www.Sôlt.house

Facebook Instagram @Solt.house

—

Postage

PO BOX 5177, Burnley
VIC Australia 3121

—

Telephone

1300 11 4357

—

Email

support@residentia.group

Congratulations on purchasing your new Heat Pump Clothes Dryer.
Sôlt is proudly distributed within Australia by Residentia Group Pty Ltd.

Please refer to the warranty card at the rear of this manual for information regarding your product's parts and labour warranty, or visit us online at:
→ www.residentiagroup.com.au

At Residentia Group, we are customer obsessed and our Support Team are there to ensure you get the most out of your appliance. Should you want to learn more about your unit, and importantly, taking care of the appliance, our Support Team are here to help.

You can use our online Support Centre at any time by visiting:
→ <http://support.residentiagroup.com.au>

Or you can contact us via phone by dialling: 1300 11 HELP (4357).

It is important that you read through the following use and care manual thoroughly to familiarise yourself with the installation and operation requirements of your appliance to ensure optimum performance.

Again, thank you for choosing an Sôlt appliance and we look forward to being of service to you.

Kind Regards,
The Residentia Team



Contents

Safety Information	04
Your Clothes Dryer	06
Installation Instructions	07
Control Panel	08
Operating Instructions	09
Cleaning & Maintenance	12
Technical Specifications	14
Troubleshooting	15
Purchase Details	17
Warranty Information	18

Customer Care

Sôlt recommends the use of original spare parts.

When contacting our customer service team by calling 1300 11 4357, or by e-mailing support@residentiagroup.com.au, please ensure that you have the following information at hand.













(found on your appliances' rating plate).

- Model Number
- Serial Number

Safety Information

DRYER CARE SYMBOLS

Please pay attention to use the drying machine if the materials of your clothes can not be dried by it or contain the symbols as follows:

 Dry	 Normal	 Not tumble dry normal	 Do not dry
 Line dry / hang to dry	 Drip dry	 Dry flat	 In the shade
 Dry clean	 Do not dry clean	 Dry clean normal cycle with any solvent	 Dry clean normal cycle petroleum solvent only

CONDITIONS OF USE

This heat pump dryer is intended for drying typical amounts of household laundry, which have been washed with water. It has been designed solely for private use and is not suitable for commercial or shared use (i.e. by several families in an apartment building).

IMPORTANT!

CAUTION: RISK OF FIRE!

To prevent any damages to your and others' life or property, you have to follow the safety notes.

- This product belongs to the category of electrical appliances, and only for drying textiles which have been washed with water in the household.
Please pay attention to the safety of power use during the operation!
- The power source with reliable earthing must be used. Its earth wire must be buried under the ground and shall not be connected with the public utilities such as city water pipe or gas pipe etc. The earth wire and null wire shall be distinguished and shall not be connected together.
- The maximum mass of dry textile material is 8 kilograms to be used in the appliance.
- That the tumble dryer is not to be used if industrial chemicals have been used for cleaning.
- Do not dry unwashed items in the tumble dryer.
- Adequate ventilation has to be provided to avoid the back flow of gases into the room from appliance burning other fuels, including open fires
- **WARNING:** never stop a tumble dryer before the end of the drying cycle unless all items are quickly removed and spread out so that the heat is dissipated.
- The exhaust air must not be discharged into a flue which

is used for exhausting fumes from appliance burning gas or other fuels.

- The appliance must not be install behind a lockable door, a sliding door or a door with a hinge on the opposite side to that of the tumble dryer. In such a way that a full opening of the tumble dryer door is restricted.
- Keep pets away from this appliance.
- Oil-affected items can ignite spontaneously, especially when exposed to heat sources such as in a tumble dryer. The items become warm, causing an oxidation reaction in the oil. Oxidation creates heat. If the heat cannot escape, the items can become hot enough to catch fire. Piling, stacking or storing oil-affected items can prevent heat from escaping and so can create a fire hazard.
- If it is unavoidable that fabrics that contain vegetable or cooking oil or have been contaminated by hair care products be placed in a tumble dryer they should first be washed in hot water with extra detergent-this will reduce, but not eliminate, the hazard.
- The appliance should not be overturned during normal use or maintenance.
- If the power cable is damaged, it must be replaced by the manufacturer, its service agent or similarly qualified persons in order to avoid a hazard.
- This appliance is for indoor use only.
- The openings must not be obstructed by a carpet;
- Children of less than 3 years should be kept away unless continuously supervised. If the appliance appear high temperature abnormally, please draw the mail plug immediately.
- The appliance is not intended for use by persons (including children) with reduced physical, sensory or mental capabilities, or lack of experience and knowledge, unless they have been given supervision or instruction concerning use of the appliance by a person responsible for their safety. Children should be supervised to ensure that they do not play with the appliance.
- To ensure your and your family's safety, please make improvement immediately if any power use at your home does not meet the above-mentioned requirement.

ELECTRIC SHOCK HAZARD

- Do not draw the power cord forcefully to pull out the mains plug.
- Please do not plug/draw the mains plug with wet hands.
- Do not damage the power cord and the power plug.

INJURY DANGER

- Do not disassemble and install the dryer under no instruction or supervision.
- Do not stack this dryer on washing machine without stacking kits.(if want stacking on washing machine, please purchase the Independent parts and it must be installed by the manufacturer, its service agent or

Safety Information (Continued)

similarly qualified persons in order to avoid a hazard.)

- Do not lean on the opened door of the dryer.
- Do not put any objects on the dryer, such as a candle or electric cooker.

DAMAGE DANGER

- Do not dry over the rated capacity.
- Do not operate the dryer without the filter door and filter base.
- Do not dry the clothes before being spun.
- Do not expose the dryer directly under the sun, and indoor use only.
- Do not install the dryer in the humid and drenching environment.
- At the cleaning and maintenance, please do remember to pull out the power plug and do not directly wash the dryer with water.

EXPLOSION & FIRE DANGER

- Please do not dry the clothes with some flammable substances such as the coal oil, alcohol or there will be the explosion.
- The appliance contains an environmentally friendly but flammable R290 refrigerant. Keep away from open flame And other sources of ignition.
- The tumble dryer is not to be used if industrial chemicals have been used for cleaning.
- Do not dry unwashed items in the tumble dryer.
- Items that have been soiled with substances such as cooking oil, acetone, alcohol, petrol, kerosene, spot removers, turpentine, waxes and wax removers should be washed in hot water with an extra amount of detergent before being dried in the tumble dryer.
- Items such as foam rubber (latex foam), shower caps, waterproof textiles, rubber backed articles and clothes or pillows fitted with foam rubber pads should not be dried in the tumble dryer.
- Fabric softeners, or similar products, should be used as specified by the fabric softener instructions.
- Oil-affected items can ignite spontaneously, especially when exposed to heat sources such as in a tumble dryer.
- The items become warm, causing an oxidation reaction in the oil. Oxidation creates heat. If the heat cannot escape, the items can become hot enough to catch fire. Piling, stacking or storing oil-affected items can prevent heat from escaping and so create a fire hazard.
- Remove all objects from pockets such as lighters and matches.
- If it is unavoidable that fabrics that contain vegetable or cooking oil or have been contaminated by hair care products be placed in a tumble dryer they should first be washed in hot water with extra detergent. This will reduce, but not eliminate, the hazard.
- **WARNING:** Never stop a tumble dryer before the end of the drying cycle unless all items are quickly removed and

spread out so that the heat is dissipated.

- Openings must not be obstructed.
- The lint trap has to be cleaned frequently.
- Lint must not to be allowed to accumulate around the dryer.

UV RADIATION SAFETY

- This warning only covers products which contain a UV-C lamp and which have a germs reduction function with UV-C lamp.
- The device contains a lamp that emits UV-C rays. Do not look at the source of light while the lamp is operating!
- UV-C Lamp is used to provide germs reduction in textile products.
- Do not take the UV-C Lamp out of the device and do not operate it outside!
- Do not touch the lamp!
- Use of the product except for its purpose or damage to the UV-C lamp protection glass or surrounding may cause dangerous UV-C radiation to occur. UV-C radiation can damage the eyes and skin even in low doses. Do not operate any product which is damaged!
- Do not remove the UV-C lamp protection glass. Do not operate the product without the UV-C lamp protection glass!
- After the appliance stops due to various reasons (power outage, fuse problem, machine door opening, etc.) while UV Hygiene Programs are in progress, the program will resume to germs reduction from where it left.
- In cases where UV-C lamp and related parts need to be replaced (expiration of lamp life, break of lamp glass, etc.), call the technical service. Do not try to replace the parts by yourself. When waiting for technical service, make sure the machine is closed and the plug is disconnected!
- Keep children away while using any programmes with activated UV-C Lamp!
- Always read the product guide before using the device and use the product according to the instructions!
- The placement of the UV Lamp and lamp protector glass in your product is visually indicated.
- Hygiene programme incorporating UV is effective for removing Escherichia coli, Staphylococcus aureus bacteria

DISPOSAL OF PACKAGING

The packaging is designed to protect the appliance from damage during transportation. The packaging materials are environmentally friendly and should be recycled. Recycling the packaging can reduce the use of raw materials in the manufacturing process and the amount of waste in landfill sites.

Your Clothes Dryer

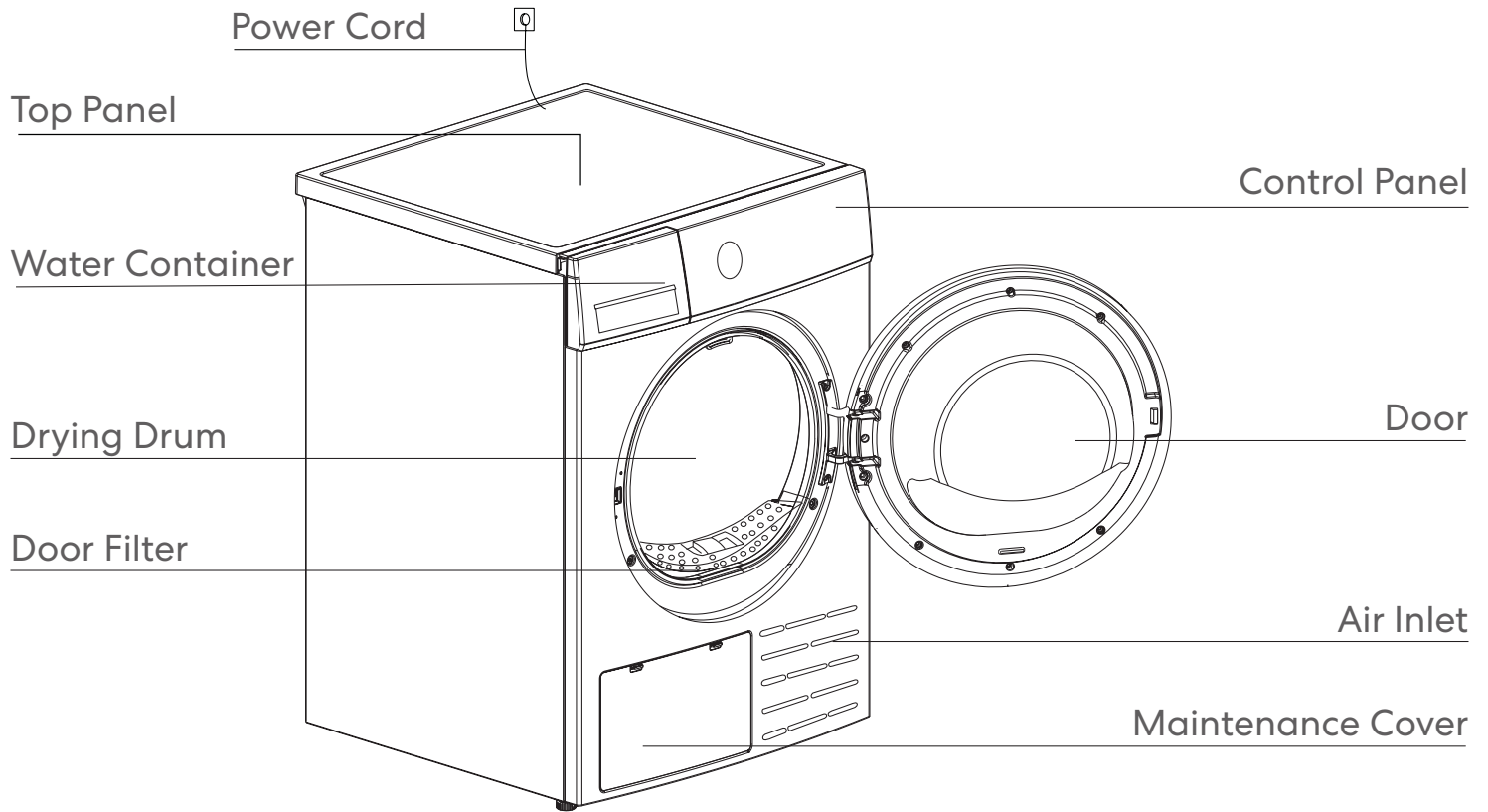

NOTE!

The images in this user manual are for reference only. Your appliance may appear differently.

ACCESSORIES

The following parts are necessary if you wish to use the drain hose to drain the water externally. Please follow the instructions below to do this.

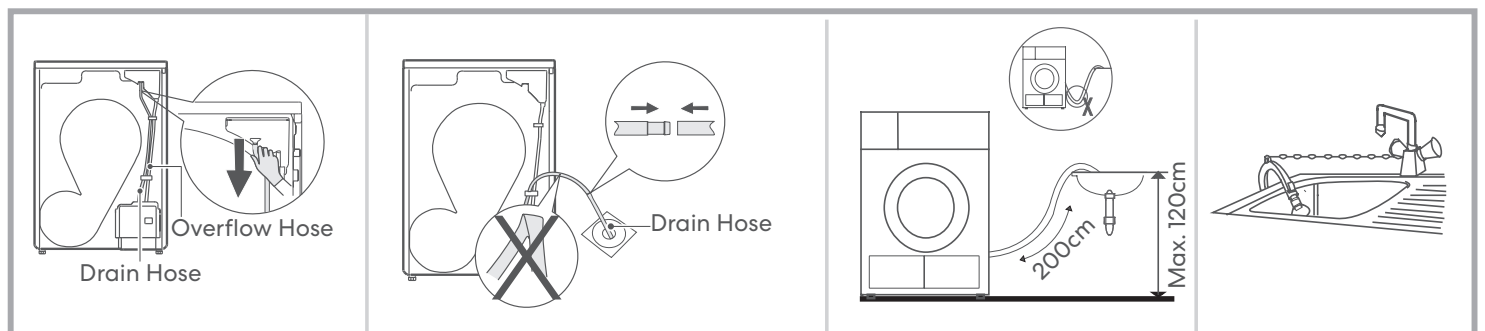
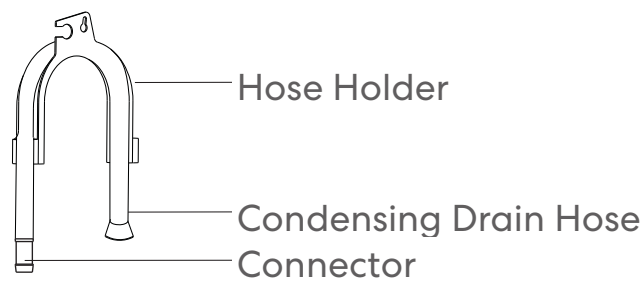

1. Pull out the upper drain hose

2. Put the external drain hose into the floor drain (be careful not to bend the external drain hose)

3. Put the hose holder in the washing basin or any other sink.

Installation Instructions

IMPORTANT!

If the power cord is damaged, it must be replaced by Residencia Group or one of its authorised service representatives. Please contact 1300 11 HELP (4357) and ensure the appliance is completely disconnected from the power supply.

TRANSPORT

Move cautiously. Never grasp any salient parts of machine. The door cannot be used as the handle for transport. If the dryer can't be transported upright the dryer can be tilted at an angle less than 30°.

Risk of injury and damage! Improper handling of the appliance may result in injury.

- The appliance is heavy. Never transport or carry the appliance alone; always with the assistance of another person.
- Remove all obstacles on the transport route and from the installation location, e.g. open doors and clear away objects lying on the floor.
- Do not use the open door as a handhold.
- Remove all package material before using the appliance.
- Before setting up the tumble dryer, check it for any externally visible damage. Do not install or use a damaged tumble dryer.
- Do not install the tumble dryer in a room where there is a risk of frost occurring. At temperatures around freezing point the tumble dryer may not be able to operate properly. There is a risk of damage if the condensed water is allowed to freeze in the pump and hoses.

INSTALLATION POSITIONING

- Children can become entangled in the packaging film or swallow small parts and suffocate. Do not allow children to play with the packaging.
 - The appliance must not be installed behind a lockable door, a sliding door or a door with a hinge on the opposite side to that of the tumble dryer, in such a way that a full opening of the tumble dryer door is restricted.
 - Do not restrict the floor clearance through deep pile carpets, strips of wood or similar. This might cause heat built-up which would interfere with the operation of the appliance.
1. It is recommended that, for your convenience, the machine is positioned close to your washing machine.
 2. Do not stack this dryer on washing machine without stacking kits. (If you want to stack this dryer on a washing machine, please purchase the independent parts. Installation shall be done by the manufacturer, its service agent or similarly qualified persons to avoid any hazards.)
 3. The tumble dryer must be installed in a clean place, where dirt does not accumulate. Air must be able to circulate freely around the appliance. Do not obstruct the front air inlet or the air intake grilles at the back of the machine.
 4. To keep vibration and noise to a minimum level when the dryer is in use, it must be placed on a firm and level surface.
 5. The feet must never be removed.

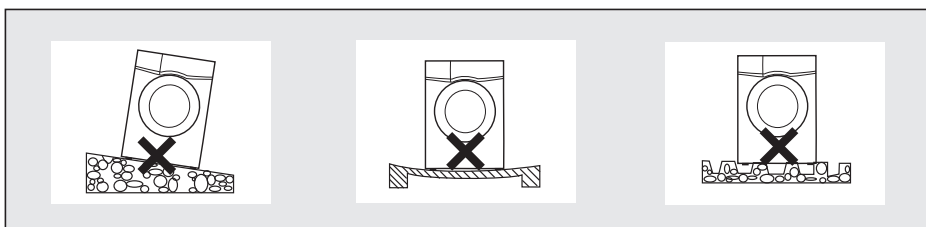

LEVEL ADJUSTING

Once in its permanent operating position, check that the dryer is absolutely level with the aid of a spirit level. If it is not, adjust the feet by hand or using a tool.

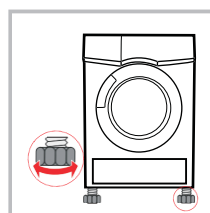

POWER SUPPLY CONNECTION

1. Make sure that the voltage of the power supply is the same as the electric specification.
2. Do not connect the dryer with the power connection board, a universal plug or socket, do not use multi-plug adapters and extension cables.

Control Panel

YOUR CONTROL PANEL

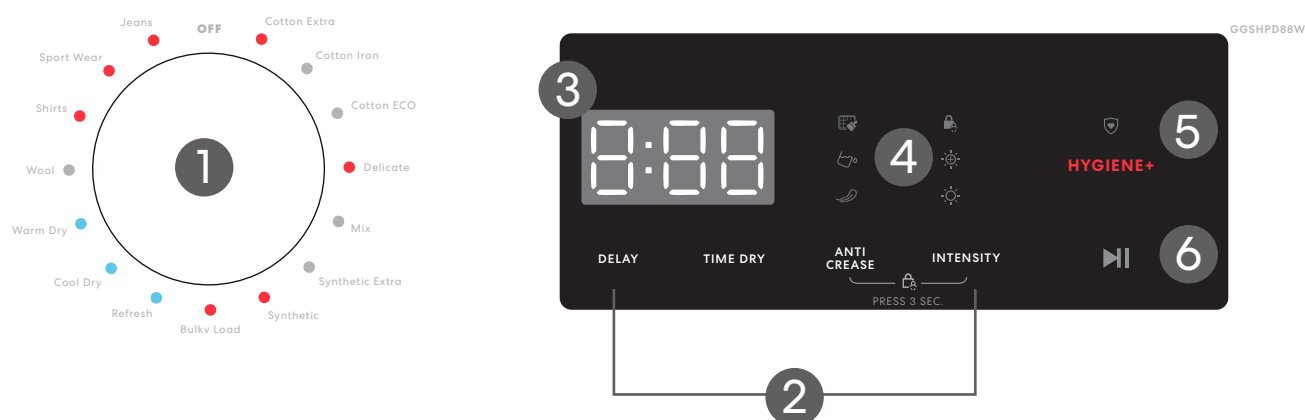

1. Program control dial
2. Additional Function Buttons
3. LED Display Screen
4. Function & Warning Indicators
5. Start/Pause
6. Hygiene+

DISPLAY SCREEN SYMBOLS

	Clean Filters Warning
	Empty Water Container Warning
	Anti Crease
	Child Lock
	Intensity (Dryness Level Extra)
	Intensity (Dryness Level Standard)
	Hygiene+ (UV Sterilising)
	Remaining Time / Error Message Display

Operating Instructions

BEFORE FIRST USE

Leave it to stand for 2 hours after transporting.

Before first use, please use some soft fabric to clean the inside drum.











1. Put some clean rags into the drum
2. Plug the power, turn the program dial to select the Refresh Program
3. Press Start/Pause button
4. After finishing this program, please refer to the "Maintenance and Cleaning" section to clean the door filter.

Note: During drying, the compressor and the water will generate some noise which is completely normal.

BEFORE DRYING

1. Before drying, thoroughly spin the laundry in washing machine. High spin speed shortens the drying time and saves energy.
2. For uniform drying result, sort the laundry according to fabric type and select the appropriate drying program.
3. Before drying, please close zips, hooks and eyelets, button, tie fabric belts, etc.
4. Remove all objects from pockets such as lighters and matches.
5. Sew in or remove under wiring from bras.
6. Close duvet covers and pillow cases to prevent small items from being rolled up inside them.
7. Leave jackets open and undo any long zips so that textiles dry evenly.
8. Do not over dry the clothes, because over dried clothes can easily get creases.
9. Do not dry the articles containing rubber or similar elastic materials.
10. Keep the area around the tumble dryer clean. Coal dust or flour may cause an explosion.
11. The door shall be opened only after the program of the tumble dryer is finished to avoid being scalded by hot steam or over heated drying machine.
12. Clean the lint filter and empty water container after each use to avoid extension of drying time and increase of energy consumption.
13. Do not dry clothes after dry-clean process.

APPROXIMATE WEIGHTS OF DRY CLOTHES

 Sweater (mixed 800g)	 Jacket (cotton 800g)	 Jeans (800g)	 Bath Towel (cotton 900g)
 Single bedsheet (cotton 600g)	 Work clothes (1120g)	 Pyjamas (200g)	 Shirt (cotton 300g)
 T-Shirt (cotton 180g)	 Underwear (cotton 70g)	 Socks (mixed-weave 50g)	

Note: Do not put more clothing in the dryer than the rated capacity.
Do not dry dripping wet laundry, it may damage the laundry.

Operating Instructions (Continued)

USING THE ADDITIONAL FUNCTIONS

DELAY FUNCTION

This function is used for delaying the start of the drying program up to 24 hours. When the delayed program starts, the time starts to countdown on the display and the delay icon blinks.

1. Load your laundry and make sure the machine door is closed.
2. Rotate the **program selector knob** to select the desired program.
3. You can additionally select the **Anti Crease** function according to your needs.
4. Press the **Delay** button.
5. Repeatedly press the **Delay** button to select the desired delay time.
6. Then press the **Start/Pause** button and the dryer will be in standby and the delay time will start counting down. The drying procedure will be automatically performed when the delay time is over.
7. If you press the **Start/Pause** button again, the delay function will be paused.
8. If you want to cancel the "Delay" function, please rotate the **program selector knob** to off.

TIME DRY

When the **Time Dry** program is selected, the **Time Dry** button can be used to adjust the drying time in 10 minute increments.

ANTI CREASE FUNCTION

At the end of the drying cycle, the anti crease operation time is automatically set to 30 minutes or 120 minutes if you select it. Press the **Anti Crease** button to select the time. If you do not want to use this function simply remove your laundry at the end of the cycle.

This function prevents the laundry from creases. The laundry can be removed during the Anti Crease phase. This function cannot be used with the Wool program.

INTENSITY

You can adjust the dryness level of the laundry by pressing the **Intensity** button.

1. The intensity function can be activated only before the program starts.
2. Except the Cotton ECO, Cotton Extra, Iron, Wool and Time program, all the other programs can be adjusted with the Intensity function.

HYGIENE+

1. After selecting a program, you can choose the Hygiene+ function according to your needs.
2. Press **Hygiene+** button to select this function.
3. Press it again to cancel.

After selecting the Hygiene+ button, germs are removed during the drying process using the UV light, making the clothes cleaner and safer. Use this function with caution for light, thin or delicate laundry.

This program can be used with Jeans, Bulky Load, Sport Wear, Cotton Extra, Delicate, Mix, Synthetic Extra, Synthetic and Shirts programs are compatible with the Hygiene+ function.

CHILD LOCK

This machine incorporates a special child safety lock, which can prevent children from carelessly pressing buttons and doing damage to themselves or the appliance.



1. When the drying cycle is running, press the **Anti Crease** button and the **Intensity** button at the same time for 3 seconds to start the child lock function.
2. When child lock function is set, the display will show Child lock icon and all button are deactivated.
3. To deactivate the child lock function, the **Anti Crease** button and the **Intensity** button shall be pressed at the same time for 3 seconds.

Operating Instructions (Continued)

DRYING PROGRAMS TABLE

PROGRAM		MAX LOAD	RECOMMENDED USE/ PROPERTIES	DELAY	TIME
Cotton	Extra	8.0kg	For single or multi layered cotton laundry to be dried completely for immediate storage.	Y	N
	Iron		For single layered cotton to remain damp for ironing.	Y	N
	ECO		For single or multi-layer cotton laundry to be dried completely for direct wear.	Y	N
Delicate	-	1.0kg	For delicate laundry that is suitable for drying or laundry advised to be hand washed at a low temp.	Y	N
Mix	-	3.5kg	For mixed fabrics from cotton and synthetics.	Y	N
Synthetics	Extra	3.5kg	For thick or multi-layer synthetic fabrics to be dried completely	Y	N
	Cupboard		To dry thin synthetic textiles, which are not ironed, such as easy care shirts, baby cloths or socks.	Y	N
Jeans	-	8.0kg	To dry jeans or denim clothes that are spun at high speed in the washing machine.	Y	N
Sports	-	3.0kg	To dry sportswear and thin fabrics from polyester, which are not ironed.	Y	N
Shirts	-	1.0kg	For easy care laundry such as shirts and blouses equipped with Anti Crease functionality to minimise the ironing effort. Place clothes loosely in the dryer. Once dried, remove quickly and hang it on a clothes hanger.	Y	N
Wool	-	1.0kg	To refresh you wool items and make them more fresh and fluffy.	Y	N
Time	Warm Dry	-	To dry individual items or to finish the drying process of multi-layer fabrics with different drying behaviour, such as jackets, pillows or voluminous items. Min. 10 minutes – Max. 150 minutes.	Y	Y
	Cool Dry	-	To air items without heating. Min. 10 minutes – Max. 30 minutes.	Y	Y
	Refresh	1.0kg	To refresh clothes that have beenkept in a closed environment for a long time or to remove odors. Min. 20 minutes – Max. 180 minutes.	Y	Y
Bulky Load	-	3.5kg	To dry bed linen, bed sheets or other large items.	Y	N

NOTE FOR TEST INSTITUTES:

1. Jeans + Intensity  programme in accordance with Regulation AS/NZS 2442.2 for energy labelling, measured in accordance with AS/NZS2442.1 and suitable for drying normal cotton load at rated load capacity.
2. Jeans + Intensity  programme is suitable for drying normal wet cotton laundry and it is the most efficient programme in terms of energy consumption for cotton.

Cleaning & Maintenance

CLEANING AND CARE

EMPTYING THE WATER CONTAINER

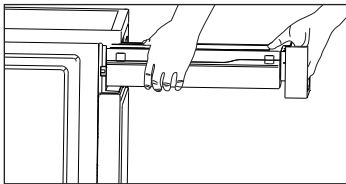

Pull out the water container and keep level with two hands.

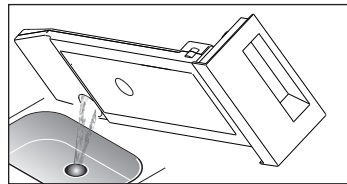

Tilt the water container to pour out condensate into the basin.

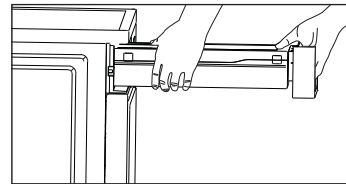

Reinstall the water container once empty.

WARNING!

Empty the water container after each use. Once the water container is filled completely, the program will be paused and the "👉" icon will light. After the container is emptied, the dryer can be restarted by pressing **Start/Pause** button.

- Do not drink the condensate water.
- Do not use the dryer without the water container.

CLEANING THE DOOR FILTER

This dryer has a primary door lint filter. Make sure you clean the door filter after each cycle to avoid increased energy consumption and cycle time

1. Open the door.
2. Take out the door filter.
3. Open the filter and remove the fluff on the filter by hand. You can use a vacuum cleaner to help clean it.
4. Throw lint in the garbage bin and do not wash it down the drain to avoid micro plastics in the used water system.
5. Reinstall the door filter.

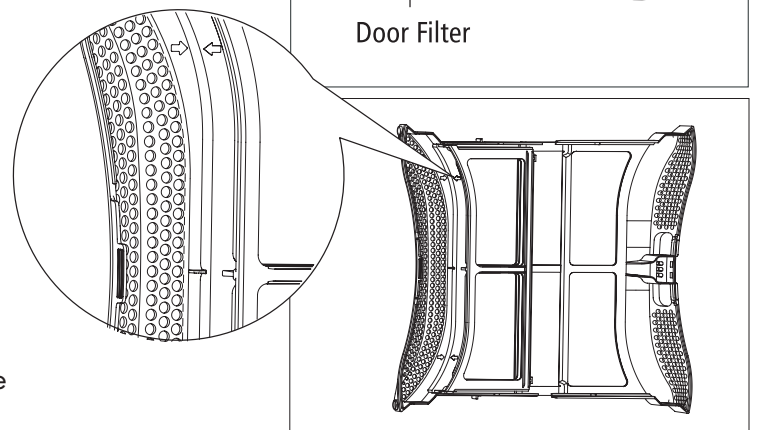
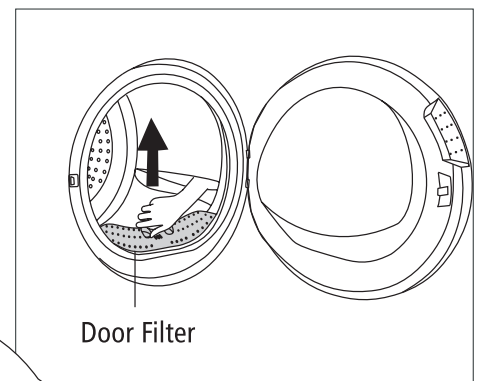

WARNING!

- The fluff accumulated on the filter will block the air circulation. Not cleaning the filter regularly will increase drying time and energy consumption.
- Disconnect the power cord before cleaning!
- Do not operate the dryer without the filter!

CLEANING THE LOWER FILTER

1. Open the service panel
2. Detach the clips holding the cover and remove the cover
3. Remove the lower filter, clean it thoroughly and replace filter
4. Replace the cover and fasten the clips
5. Close the service panel

Cleaning & Maintenance (Continued)

CLEANING THE HEAT EXCHANGER

WARNING! Do not touch the heat exchanger with your hand as it may cause injury.

As necessary, approx. once every 3 months, remove the fluff from the heat exchanger using a vacuum cleaner with a dusting brush attached. Clean the heat exchanger without applying any pressure. Otherwise the heat exchanger could be damaged. The dryer will not dry if the cooling fins are damaged or bent.

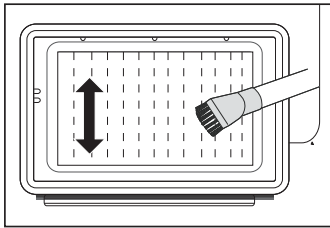

MAINTENANCE

WARNING!

- Disconnect the power cord before cleaning.
- Clean the dryer with a clean damp cloth only.
- Do not use solvents, abrasive cleaners, glass cleaners or all-purpose cleaners. These could damage plastic surfaces and other parts.
- Please wear gloves when cleaning.

CLEANING YOUR DRYER

- Prepare a clean damp cloth using clean water.
- Clean the door, especially the inside window.
- Clean the sealing around the door opening.
- Clean the humidity sensor inside the drum.
- Take out the filter, clean the sealing and air flow openings.
- Before starting the dryer, dry all parts with a soft cloth.

Technical Specifications

Below outlines the technical specifications for your Sôlt Heat Pump Dryer.

Model	GGSHPD88W
Size	595W × 600D × 850H (mm)
Ambient Temperature	+2°C ~ +35°C
Rated Input Power	800W
Rated Voltage	220-240V~
Rated Frequency	50Hz
Refrigerant/Amount	R290/120g
Net Weight	41kg
Rated Capacity	8.0kg
GWP	3
CO ² - eq	0.00t

Note:

- The rated capacity is the maximum capacity to be dried at one time. Make sure that the dry clothes which are loaded into the appliance do not exceed the rated capacity.
- Do not install the tumble dryer in a room when there is a risk of frost occurring. At temperatures around freezing point the tumble dryer may not be able to operate properly.
- There is a risk of damage if the condensate water is allowed to freeze in the pump, hoses and / or condensate water container.



Troubleshooting

OPERATION IN CASE OF EMERGENCY

In the event of an emergency you should:

- Rotate the knob to the Off position.
- Switch the washing machine off at the power point or at the fuse box.
- Call the Residentia Support Team on 1300 11 HELP (4357).

Some minor faults can be fixed by referring to the instructions given in the Troubleshooting section below. There is also a self-help section online at <https://support.residentiaigroup.com.au/>

DESCRIPTION	SOLUTION
Display is not on	<ul style="list-style-type: none"> • Check if the power supply works. • Check if the mains plug is inserted. • Check the selected program.
 Displays	<ul style="list-style-type: none"> • Check the water container. If it's full, please pour out the condensate water and restart the dryer. • If the container is not full, please restart the dryer. • If the  icon is still lit after you have finished the first two steps, please contact the after sales service team.
 Displays	<ul style="list-style-type: none"> • Clean the lint filter.
Dyer does not start	<ul style="list-style-type: none"> • Connect the dryer to the mains. • Turn on the tumble dryer. • Check the door is closed. • Check the program is set. • Press the Start/Pause button.
Clothes not properly dry or drying time is taking too long	<ul style="list-style-type: none"> • Clean lint filter. • Empty the water container. • Check the drain hose. • Check installation place is appropriate. • Keep the air inlet clean. • Use higher drying intensity level program or time program.
There are humming noises	<ul style="list-style-type: none"> • The compressor is operating. These noises are quite normal and do not indicate a fault.
The dryer switches off at the end of the program	<ul style="list-style-type: none"> • This is normal operation. The dryer will switch off automatically for energy saving

Troubleshooting (continued)

ERROR MESSAGES AND SOLUTIONS

WARNING! Never dismantle the dryer.

INDICATION	REASON	SOLUTION
"E82" displays	PCB Communication error.	Please contact the Residentia Group support team on 1300 11 HELP (4357).
"E33" displays	Temperature sensor error.	
👉 displays	Water pump failure or water level sensor failure.	
	Water Container is full.	Empty the water container.

WARNING!

- Only authorised technicians can carry out repairs.
- If the LED displays other prompt and the dryer does not work, please call the Residentia Group support team.

Purchase Details

For future reference, please record the following information which can be found on the rating plate and the date of purchase which can be found on your sales invoice.

STORE DETAILS

STORE NAME |

ADDRESS |

TELEPHONE |

PURCHASE DATE |

PRODUCT DETAILS

MODEL NO. |

SERIAL NO.* |

Attach Your Receipt Here

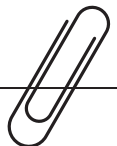

Warranty Information

WARRANTY TERMS AND CONDITIONS LAUNDRY APPLIANCES

This document sets out the terms and conditions of the product warranties for Residentia Group Appliances. It is an important document. Please keep it with your proof of purchase documents in a safe place for future reference should you require service for your Appliance.

1. **IN THIS WARRANTY**
 - (a) 'acceptable quality' as referred to in clause 10 of this warranty has the same meaning referred to in the ACL;
 - (b) 'ACL' means Trade Practices Amendment (Australian Consumer Law) Act (No.2) 2010;
 - (c) 'Appliance' means any Residentia Group product purchased by you accompanied by this document;
 - (d) 'ASR' means Residentia Group authorised service representative;
 - (e) 'Residentia Group' means Residentia Group Pty Ltd of 165 Barkly Ave, Burnley VIC 3121, ACN 600 546 656 in respect of Appliances purchased in Australia;
 - (f) 'major failure' as referred to in clause 10 of this warranty has the same meaning referred to in the ACL and includes a situation when an Appliance cannot be repaired or it is uneconomic for Residentia Group, at its discretion, to repair an Appliance during the Warranty Period;
 - (g) 'Warranty Period' means:
 - (i) where the Appliance is used for personal, domestic or household use (i.e. normal single family use) as set out in the instruction manual, the Appliance is warranted against manufacturing defects for 24 months, following the date of original purchase of the Appliance;
 - (h) 'you' means the purchaser of the Appliance not having purchased the Appliance for re-sale, and 'your' has a corresponding meaning.
2. This warranty only applies to Appliances purchased and used in Australia and is in addition to (and does not exclude, restrict, or modify in any way) any non-excludable statutory warranties in Australia.
3. During the Warranty Period Residentia Group or its ASR will, at no extra charge if your Appliance is readily accessible for service, without special equipment and subject to these terms and conditions, repair or replace any parts which it considers to be defective. Residentia Group or its ASR may use remanufactured parts to repair your Appliance. You agree that any replaced Appliances or parts become the property of Residentia Group. This warranty does not apply to light globes, batteries, seals, filters or similar perishable parts.
4. Parts and Appliances not supplied by Residentia Group are not covered by this warranty.

5. You will bear the cost of transportation, travel and delivery of the Appliance to and from Residentia Group or its ASR. If you reside outside of the service area, you will bear the cost of:
 - (a) travel of an authorised representative;
 - (b) transportation and delivery of the Appliance to and from Residentia Group or its ASR, in all instances, unless the Appliance is transported by Residentia Group or its ASR, the Appliance is transported at the owner's cost and risk while in transit to and from Residentia Group or its ASR.
6. Proof of purchase is required before you can make a claim under this warranty.
7. You may not make a claim under this warranty unless the defect claimed is due to faulty or defective parts or workmanship. Residentia Group is not liable in the following situations (which are not exhaustive):
 - (a) the Appliance is damaged by:
 - (i) accident
 - (ii) misuse or abuse, including failure to properly maintain or service
 - (iii) normal wear and tear
 - (iv) power surges, electrical storm damage or incorrect power supply
 - (v) incomplete or improper installation
 - (vi) incorrect, improper or inappropriate operation
 - (vii) insect or vermin infestation
 - (viii) failure to comply with any additional instructions supplied with the Appliance;
 - (b) the Appliance is modified without authority from Residentia Group in writing;
 - (c) the Appliance's serial number or warranty seal has been removed or defaced;
 - (d) the Appliance was serviced or repaired by anyone other than Residentia Group, an authorised repairer or ASR.
8. This warranty, the contract to which it relates and the relationship between you and Residentia Group are governed by the law applicable where the Appliance was purchased.
9. To the extent permitted by law, Residentia Group excludes all warranties and liabilities (other than as contained in this document) including liability for any loss or damage whether direct or indirect arising from your purchase, use or non use of the Appliance.
10. For Appliances and services provided by Residentia Group in Australia, the Appliances come with a guarantee by Residentia Group that cannot be excluded under the Australian Consumer Law. You are entitled to a replacement or refund for a major failure and for compensation for any other reasonably foreseeable loss or damage. You are also entitled to have the Appliance repaired or replaced if the Appliance fails to be of acceptable quality and the failure does not amount to a major failure. The benefits to you given by this warranty are in addition to your other rights and remedies under a law in relation to the Appliances or services to which the warranty relates.
11. At all times during the Warranty Period, Residentia Group shall, at its discretion, determine whether repair, replacement or refund will apply if an Appliance has a valid warranty claim applicable to it.
12. Missing parts are not covered by warranty. Residentia Group reserves the right to assess each request for missing parts in a case by case basis. Any parts that are not reported missing in the first week after purchase will not provide free of charge.
13. To enquire about claiming under this warranty, please follow these steps:
 - (a) carefully check the operating instructions, user manual and the terms of this warranty;
 - (b) have the model and serial number of the Appliance available;
 - (c) have the proof of purchase (e.g. an invoice) available;
 - (d) telephone the numbers shown below.
14. You accept that if you make a warranty claim, Residentia Group and its ASR may exchange information in relation to you to enable Residentia Group to meet its obligations under this warranty.

IMPORTANT

Before calling for service, please ensure that the steps in point 13 have been followed.

CONTACT SERVICE

→ Please call 1300 11 HELP (4357)

The Australian Consumer Law requires the inclusion of the following statement with this warranty:

Our goods come with guarantees that cannot be excluded under the Australian Consumer Law. You are entitled to a replacement or refund for a major failure and for compensation for any other reasonably foreseeable loss or damage. You are also entitled to have the goods repaired or replaced if the goods fail to be of acceptable quality and the failure does not amount to a major failure.

**An initiative by
Residentia Group**



ESSENTIALS FOR LIFE

**T. 1300 11 4357
E. support@residentiagroup.com.au**

www.solt.house



E2447

SÔLT