

HYUNDAI
POWER PRODUCTS

PETROL HEDGE TRIMMER HYHT2600X

USER MANUAL

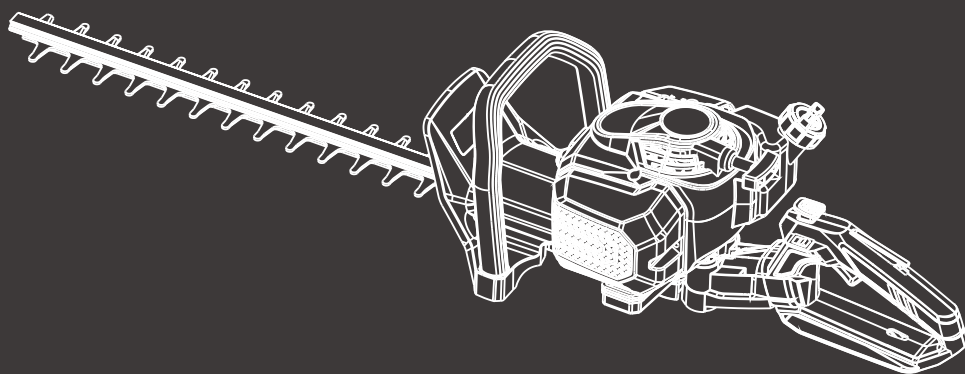

CONTENTS

Contents

Contents.....	2
Note the following before starting:.....	2
Features.....	3
KEY TO SYMBOLS	
Symbols - CO warning.....	4
GENERAL SAFETY PRECAUTIONS	
Important.....	5
Personal protective equipment.....	5
Machine's safety equipment.....	6
FUEL HANDLING	
Fuel safety.....	9
Fuel.....	9
Fueling.....	10
STARTING AND STOPPING	
Check before starting.....	11
Starting and stopping.....	11
WORKING TECHNIQUES	
General working instructions.....	13
MAINTENANCE	
Muffler.....	15
Cooling system.....	15
Spark plug.....	15
Air filter.....	16
Gear.....	16
Cutting unit.....	16
Cleaning and lubrication.....	17
Maintenance schedule.....	18
TECHNICAL DATA	
Technical data.....	19
ENVIRONMENTAL	
Recycling & Disposal.....	20
Environmental Protection.....	21
USEFUL INFORMATION	
Our YouTube Channel.....	21
Warranty.....	21
Manual Updates.....	21
Returning Your Products.....	21
Leaving A Review.....	21
Ordering Spare Parts.....	21
Contact Us.....	21
Declaration Of Conformity.....	22

Note the following before starting:

Please read the operator's manual carefully.



WARNING! Long-term exposure to noise can result in permanent hearing impairment. So always use approved hearing protection.



WARNING! Under no circumstances may the design of the machine be modified without the permission of the manufacturer. Always use genuine accessories. Non-authorized modifications and/or accessories can result in serious personal injury or the death of the operator or others.



WARNING! Incorrect or careless use of a hedge trimmer can turn it into a dangerous tool that can cause serious or even fatal injury. It is extremely important that you read and understand the contents of this operator's manual.

FEATURES

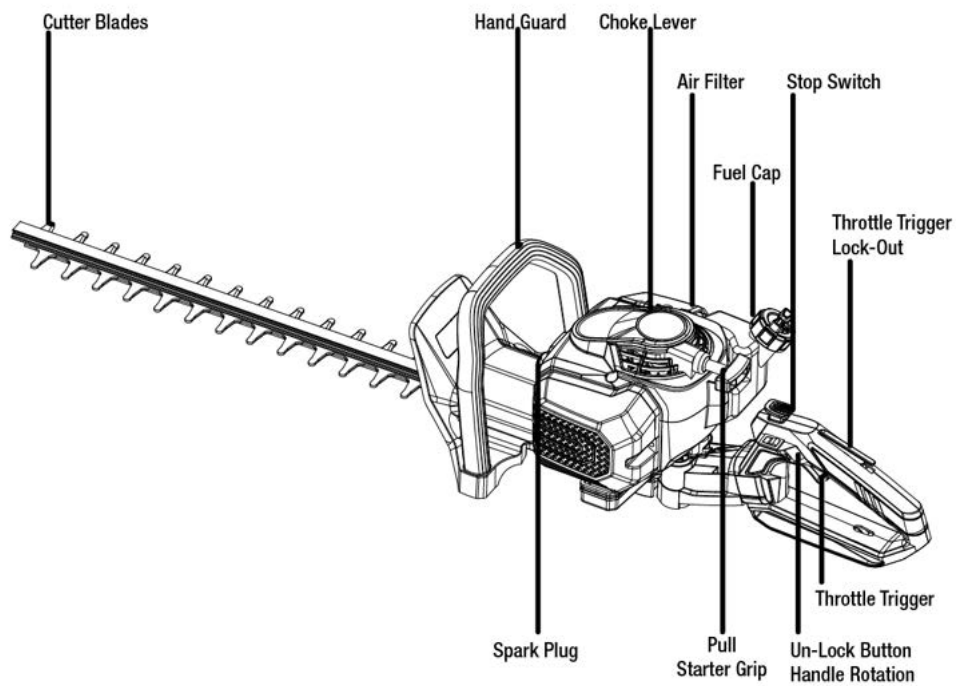

KEY TO SYMBOLS

Symbols



WARNING! Incorrect or careless use of a hedge trimmer can turn it into a dangerous tool that can cause serious or even fatal injury. It is extremely important that you read and understand the contents of this operator's manual.



Please read the operator's manual carefully and make sure you understand the instructions before using the machine.



Always wear head, ear and eye protection.



This product complies with the applicable European directives and an evaluation method of conformity for these directives was done.



Protective gloves are highly recommended when working.



Non-skid heavy duty footwear are highly recommended when working.



Noise emission to the environment according to the European Community's Directive. The machine's emission is specified in chapter Technical data and on label.



High temperature. Do not touch.



Do not use near open flames. Do not smoke.



The blade is sharp, do not touch the blade.



Waste electrical products should not be disposed of with household waste. Please recycle where facilities exist. Check with your local authority or local store for recycling advice.

Other symbols/decals on the machine refer to special certification requirements for certain markets.

The engine is switched off by moving the stop switch to the stop position. **CAUTION!** The stop switch automatically returns to the start position. In order to prevent unintentional starting, the spark plug cap must be removed from the spark plug when assembling, checking and/or performing maintenance.

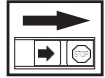

Always wear approved protective gloves.



Regular cleaning is required.

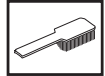

Visual check.



Protective goggles or a visor must be worn.



⚠ DANGER!

BREATHING IN CARBON MONOXIDE FUMES CAN KILL YOU!

To help protect against CO poisoning install a Carbon Monoxide detector.

NEVER use Petrol/Diesel powered equipment inside, especially a home, garage, tent, camper-van, caravan, motorhome or boat.

EVEN if doors, windows, vents and hatches are open. Only use **OUTDOORS** and as far away from doors, windows, vents and open hatches as possible to prevent inhaling fumes.

READING MANUAL BEFORE USE WILL HELP AVOID OTHER MACHINE HAZARDS.

DO NOT use in an enclosed area or moving vehicle

GENERAL SAFETY PRECAUTIONS

Important

IMPORTANT!

The machine is only designed for cutting branches and twigs.

Never use a machine that has been modified in any way from its original specification.

Never use the machine if you are tired, if you have drunk alcohol, or if you are taking medication that could affect your vision, your judgement or your co-ordination.

Wear personal protective equipment. See instructions under the heading "Personal protective equipment".

Never use the machine in extreme weather conditions such as severe cold, very hot and/or humid climates.

Never use a machine that is faulty. Carry out the checks, maintenance and service instructions described in this manual. Some maintenance and service measures must be carried out by trained and qualified specialists. See instructions under the heading Maintenance.

All covers and guards must be fitted before starting. Ensure that the spark plug cap and ignition lead are undamaged to avoid the risk of electric shock.



WARNING! This machine produces an electromagnetic field during operation. This field may under some circumstances interfere with active or passive medical implants. To reduce the risk of serious or fatal injury, we recommend persons with medical implants to consult their physician and the medical implant manufacturer before operating this machine.



WARNING! Running an engine in a confined or badly ventilated area can result in death due to asphyxiation or carbon monoxide poisoning.



WARNING! Never allow children to use or be in the vicinity of the machine. As the machine is equipped with a spring-loaded stop switch and can be started by low speed and force on the starter handle, even small children under some circumstances can produce the force necessary to start the machine. This can mean a risk of serious personal injury. Therefore remove the spark plug cap when the machine is not under close supervision.



WARNING! Faulty blades can increase the risk of accidents.

Personal protective equipment

IMPORTANT!

Incorrect or careless use of a hedge trimmer can turn it into a dangerous tool that can cause serious or even fatal injury. It is extremely important that you read and understand the contents of this operator's manual.

You must use approved personal protective equipment whenever you use the machine. Personal protective equipment cannot eliminate the risk of injury but it will reduce the degree of injury if an accident does happen. Ask your dealer for help in choosing the right equipment.



WARNING! Listen out for warning signals or shouts when you are wearing hearing protection. Always remove your hearing protection as soon as the engine stops.

HEARING PROTECTION

Wear hearing protection that provides adequate noise reduction.



EYE PROTECTION

Always wear approved eye protection. If you use a visor then you must also wear approved protective goggles. Approved protective goggles must comply with standard EN 166 in EU countries.



GLOVES

Gloves should be worn when necessary, e.g., when fitting cutting attachments.



BOOTS

Wear sturdy, non-slip boots or shoes.



GENERAL SAFETY PRECAUTIONS

CLOTHING

Wear clothes made of a strong fabric and avoid loose clothing that can catch on twigs and branches. Always wear heavy, long pants. Do not wear jewellery, shorts sandals or go barefoot. Secure hair so it is above shoulder level.

FIRST AID KIT

Always have a first aid kit nearby.



Machine's safety equipment

This section describes the machine's safety equipment, its purpose, and how checks and maintenance should be carried out to ensure that it operates correctly. See the "What is what?" section to locate where this equipment is positioned on your machine.

The life span of the machine can be reduced and the risk of accidents can increase if machine maintenance is not carried out correctly and if service and/or repairs are not carried out professionally. If you need further information please contact your nearest service workshop.

IMPORTANT!

All servicing and repair work on the machine requires special training. This is especially true of the machine's safety equipment. If your machine fails any of the checks described below you must contact your service agent. When you buy any of our products we guarantee the availability of professional repairs and service. If the retailer who sells your machine is not a servicing dealer, ask him for the address of your nearest service agent.



WARNING! Never use a machine with faulty safety equipment. The machine's safety equipment must be checked and maintained as described in this section. If your machine fails any of these checks contact your service agent to get it repaired.

Throttle lockout

The throttle lockout is designed to prevent accidental operation of the throttle control. When you press the lock (A) (i.e. when you grasp the handle) it releases the throttle control (B). When you release the handle the throttle control and the throttle lockout both move back to their original positions. This movement is controlled by two independent return springs. This arrangement means that the throttle control is automatically locked at the idle setting.

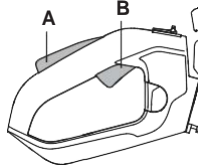

Make sure the throttle control is locked at the idle setting when the throttle lockout is released.

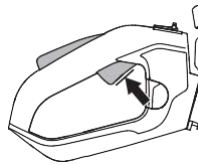

Press the throttle lockout and make sure it returns to its original position when you release it.

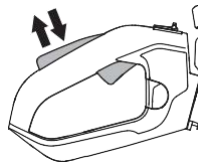

Check that the throttle trigger and throttle lockout move freely and that the return springs work properly.

See instructions under the heading Start. Start the hedge trimmer and apply full throttle. Release the throttle trigger and check that the blades stop and remain stationary. If the blades move when the throttle trigger is in the idle position then the carburettor idle setting must be adjusted. See instructions under the heading Maintenance.



GENERAL SAFETY PRECAUTIONS

Stop switch

Use the stop switch to switch off the engine.

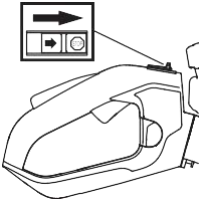

Start the engine and make sure the engine stops when you move the stop switch to the stop setting. The stop switch automatically returns to the start position. In order to prevent unintentional starting, the spark plug cap must be removed from the spark plug when assembling, checking and/or performing maintenance.

Hand guard



The hand guard prevents hands from coming into contact with the moving blades, for example, if the operator loses grip on the front handle.

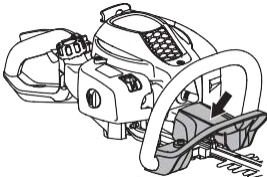

Check that the hand guard is fitted correctly.

Check that the hand guard is undamaged.

Vibration damping system



Your machine is equipped with a vibration damping system that is designed to minimize vibration and make operation easier.

The machine's vibration damping system reduces the transfer of vibration between the engine unit/cutting equipment and the machine's handle unit.

The engine body, including the blades, is suspended on the handlebar using four rubber bushings.

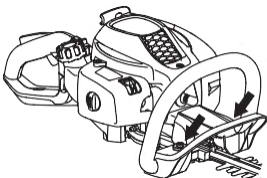

Regularly check the vibration damping units for cracks or deformation. Check that the vibration damping element is undamaged and securely attached.



WARNING! Overexposure to vibration can lead to circulatory damage or nerve damage in people who have impaired circulation. Contact your doctor if you experience symptoms of overexposure to vibration. Such symptoms include numbness, loss of feeling, tingling, pricking, pain, loss of strength, changes in skin colour or condition. These symptoms normally appear in the fingers, hands or wrists. The risk increases at low temperatures.

Muffler



The muffler is designed to keep noise levels to a minimum and to direct exhaust fumes away from the user. A muffler fitted with a catalytic converter is also designed to reduce harmful exhaust gases.



For mufflers it is very important that you follow the instructions on checking, maintaining and servicing your machine.

Never use a machine that has a faulty muffler.



Regularly check that the muffler is securely attached to the machine.



GENERAL SAFETY PRECAUTIONS



WARNING! Mufflers fitted with catalytic converters get very hot during use and remain so for some time after stopping. This also applies at idle speed. Contact can result in burns to the skin. Remember the risk of fire!



WARNING! The inside of the muffler contain chemicals that may be carcinogenic. Avoid contact with these elements in the event of a damaged muffler.



WARNING! Bear in mind that: The exhaust fumes from the engine are hot and may contain sparks which can start a fire. Never start the machine indoors or near combustible material!

Blade and blade guard



The outer part of the blades (1) are shaped as blade guards. The blade guard is intended to protect against any part of the body coming into contact with the blades.

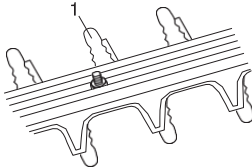

Check that the blade guard is not damaged or distorted. Replace the cutting unit if it is bent or damaged.

Residual Risks

Even when the tool is used as prescribed it is not possible to eliminate all residual risk factors. The following hazards may arise in connection with the tool's construction and design:

1. Damage to lungs if an effective dust mask is not worn.
2. Damage to hearing if effective hearing protection is not worn.
3. Health defects resulting from vibration emission if the power tool is being used over longer period of time or not adequately managed and properly maintained.

Gear

The gear housing gets hot when the machine has been in use. To avoid burning yourself do not touch the gear housing.

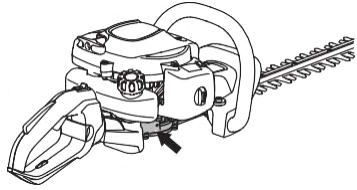

Carbon Monoxide

DANGER! CARBON MONOXIDE IS A COLOURLESS, ODOURLESS GAS. INHALING THIS GAS CAN CAUSE DEATH OR SERIOUS LONG-TERM HEALTH PROBLEMS SUCH AS BRAIN DAMAGE.

Never operate the engine in a confined space where dangerous Carbon Monoxide fumes can develop. All ignition operations have to be effected in an open or well-ventilated area. Always remember that exhaust fumes are toxic.

The symptoms of carbon monoxide poisoning can include but are not limited to the following; Headaches, dizziness, nausea, breathlessness, collapsing or loss of consciousness.

Carbon Monoxide poisoning symptoms are similar to flu, food poisoning, viral infections and simply tiredness. It is quite common for people to mistake this very dangerous poisoning for something else.

To avoid carbon monoxide poisoning DO NOT use Petrol/ Diesel powered equipment inside any of the following; Home, garage, tent, camper van, mobile home, caravan or boat. DO NOT use in an enclosed area or moving vehicle. This is not exhaustive and if you are in any doubt contact your dealer.

If you think you have or someone around you has been affected by carbon monoxide poisoning; Get them fresh air immediately, by leaving the affected area or by opening doors and windows. If safe and practical to do so make sure that the machine is turned off. DO NOT enter a room you suspect of having carbon monoxide present – instead call the emergency services.

Contact a Doctor immediately or go to Hospital – let them know that you suspect carbon monoxide poisoning.

FUEL HANDLING

Fuel safety

Never start the machine:

- 1 If you have spilt fuel on it. Wipe off the spillage and allow remaining fuel to evaporate.
- 2 If you have spilt fuel on yourself or your clothes, change your clothes. Wash any part of your body that has come in contact with fuel. Use soap and water.
- 3 If the machine is leaking fuel. Check regularly for leaks from the fuel cap and fuel lines.

Transport and storage

- Allow the hedge trimmer to cool down after use before putting it away for storage.
- Store and transport the machine and fuel so that there is no risk of any leakage or fumes coming into contact with sparks or naked flames, for example, from electrical machinery, electric motors, electrical relays/switches or boilers.
- When storing and transporting fuel always use approved containers intended for this purpose.
- When storing the machine for long periods the fuel tank must be emptied. Contact your local petrol station to find out where to dispose of excess fuel.
- Ensure the machine is cleaned and that a complete service is carried out before long-term storage.
- The transport guard must always be fitted to the cutting attachment when the machine is being transported or in storage.
- Secure the machine during transport.



WARNING! Take care when handling fuel. Bear in mind the risk of fire, explosion and inhaling fumes.

Fuel

CAUTION! The machine is equipped with a two-stroke engine and must always be run using a mixture of petrol and two-stroke oil. It is important to accurately measure the amount of oil to be mixed to ensure that the correct mixture is obtained. When mixing small amounts of fuel, even small inaccuracies can drastically affect the ratio of the mixture.



WARNING! Fuel and fuel fumes are highly inflammable and can cause serious injury when inhaled or allowed to come in contact with the skin. For this reason observe caution when handling fuel and make sure there is adequate ventilation.

Petrol



CAUTION! Always use a quality petrol/oil mixture at least 90 octane (RON). If your machine is equipped with a catalytic converter (see chapter on Technical data) always use a good quality unleaded petrol/oil mixture. Leaded petrol will destroy the catalytic converter.

Use low-emission petrol, also known as alkylate petrol, if it is available.



- The lowest octane recommended is 90 (RON). If you run the engine on a lower octane grade than 90 so-called knocking can occur. This gives rise to a high engine temperature, which can result in serious engine damage.
- When working at continuous high revs a higher octane rating is recommended.

Two-stroke oil

- Never use two-stroke oil intended for water-cooled engines.
- Never use oil intended for four-stroke engines.
- A poor oil quality and/or too high oil/fuel ratio may jeopardise function and decrease the life time of catalytic converters.

FUEL HANDLING

Mixing

- Always mix the petrol and oil in a clean container intended for fuel.
- Always start by filling half the amount of the petrol to be used. Then add the entire amount of oil. Mix (shake) the fuel mixture. Add the remaining amount of petrol.
- Mix (shake) the fuel mixture thoroughly before filling the machine's fuel tank.

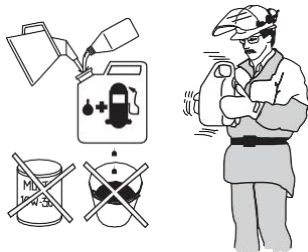

- Do not mix more than one month's supply of fuel at a time.
- If the machine is not used for some time the fuel tank should be emptied and cleaned.
- Fuel/Oil ratio is 40:1
- Use semi-synthetic 2-stroke oil.



WARNING! The catalytic converter muffler gets very hot during and after use. This also applies during idling. Be aware of the fire hazard, especially when working near flammable substances and/or vapours.

Fueling



WARNING! Taking the following precautions, will lessen the risk of fire:

Do not smoke or place hot objects near fuel.

Always shut off the engine before refuelling.

Refuel in a well ventilated area. Never fuel the machine indoors.

Always stop the engine and let it cool for a few minutes before refuelling.

When refuelling, open the fuel cap slowly so that any excess pressure is released gently.

Tighten the fuel cap carefully after refuelling.

Always move the machine away from the refuelling area and source before starting.

- Always use a fuel container with an anti-spill valve.
- Clean the area around the fuel cap. Contamination in the tank can cause operating problems.
- Ensure that the fuel is well mixed by shaking the container before filling the tank.

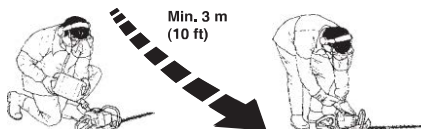

STARTING AND STOPPING

Check before starting



- Inspect the working area. Remove any objects that could be thrown out.
- Check the cutting attachment. Never use blades that are dull, cracked or damaged.
- Check that the machine is in perfect working order. Check that all nuts and screws are tight.
- Make sure the gear housing is lubricated correctly.
- Check that the cutting attachment always stops when the engine is idling.
- Only use the machine for the purpose it was intended for.
- Make sure that the handle and safety features are in good working order. Never use a machine that lacks a part or has been modified outside its specifications.
- All covers must be correctly fitted and undamaged before you start the machine.

Starting and stopping



WARNING! The complete gear housing must be fitted before the machine is started, otherwise the clutch may loosen and cause personal injury.

Always move the machine about 3 metres from the refuelling position before starting. Place the machine on a firm surface. Remember that the blades may start to move when the engine is started. Make sure the blades cannot come into contact with any object. Make sure that no unauthorised persons are in the working area, otherwise there is a risk of serious personal injury. The safety distance is 15 metres.

CAUTION! Do not pull the starter cord all the way out and do not let go of the starter handle when the cord is fully extended. This can damage the machine.

Cold engine

(1) Ignition

Set the ON/OFF switch to the ON position.

(2) Choke

1. Set the choke lever to the  start (closed) position.

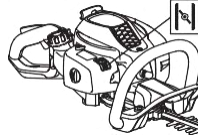

2. Press the primer bulb 6 times.



3. Pull starter cord until engine starts. Hold the body of the machine on the ground using your left hand (CAUTION! Not with your foot!). Grip the starter cord with your right hand until you feel some resistance (the starter pawls grip), now quickly and powerfully pull the cord. Never twist the starter cord around your hand.



4. After the engine has started, run for 30 seconds then squeeze the throttle trigger and the choke will return to the run (open)  position.

Warm Engine

(1) Ignition

Set the ON/OFF switch to the ON position.

(2) Choke

1. Leave choke lever in the run (open)  position.
2. Pull starter rope sharply until engine starts, but no more than 5 pulls. Hold the body of the machine on the ground using your left hand (CAUTION! Not with your foot!). Grip the starter cord with your right hand until you feel some resistance (the starter pawls grip), now quickly and powerfully pull the cord. Never twist the starter cord around your hand.
3. Squeeze the throttle gently for 30 seconds to warm the engine.

STARTING AND STOPPING

Stopping

Release the throttle trigger, then move the ON/OFF switch to OFF position.

WORKING TECHNIQUES

General working instructions

IMPORTANT!

This section takes up the basic safety precautions for working with a hedge trimmer.

If you encounter a situation where you are uncertain how to proceed you should ask an expert. Contact your dealer or your service workshop.

Avoid all usage which you consider to be beyond your capability.



WARNING! The machine can cause serious personal injury. Read the safety instructions carefully. Learn how to use the machine.



WARNING! Cutting tool. Do not touch the tool without first switching off the engine.

Safety instructions regarding the surroundings

- Never allow children to use the machine.
- Observe your surroundings and make sure that there is no risk of people or animals coming into contact with the cutting equipment.
- Ensure that no-one comes closer than 15 m while you are working.
- Never allow anyone else to use the machine without first ensuring that they have understood the contents of the operator's manual.
- Never work from a ladder, stool or any other raised position that is not fully secured.

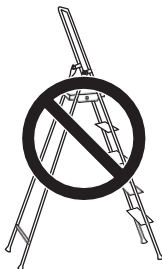

- Keep in mind that the operator is responsible for accidents or hazards occurring to other people or their property.
- Beware of overhead power lines.
- Always be aware of your surroundings and stay alert for possible hazards that you may not hear due to the noise of the machine.
- Keep the machine away from fire or sparks.
- be careful not to drop the machine or hit it against obstacles.
- The engine should be turned off when the machine is moved between work areas.

Safety instructions while working



- Always ensure you have a safe and stable working position.
- Never leave the machine unsupervised with the motor running.
- Always use both hands to hold the machine. Hold the machine in front of your body.

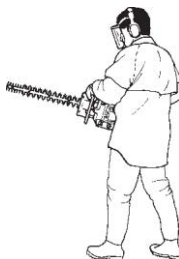

- Make sure that your hands and feet do not come near the cutting attachment when the engine is running.



- When the engine is switched off, keep your hands and feet away from the cutting attachment until it has stopped completely.
- Watch out for stumps of branches that can be thrown out during cutting.
- Do not cut too close to the ground. Stones and other objects can be thrown out.
- Check the working area for foreign objects such as electricity cables, insects and animals, etc, or other objects that could damage the cutting attachment, such as metal items.
- If any foreign object is hit or if vibrations occur stop the machine immediately. Disconnect the HT lead from the spark plug. Check that the machine is not damaged. Repair any damage.
- If you fall, release the throttle trigger immediately.
- Do not work in poor weather conditions e.g rain, thunder, lightning, wind. The ground may be slippery if wet.
- Do not use this unit for any job other than those which it is intended as described in this manual.
- Never leave the machine unattended.

WORKING TECHNIQUES

- If anything jams in the blades while you are working, switch off the engine and wait until it has stopped completely before cleaning the blades. Disconnect the HT lead from the spark plug.

Safety instructions after completing work



- The transport guard should always be fitted to the cutting attachment when the machine is not in use.
- Make sure the cutting attachment has stopped before cleaning, carrying out repairs or an inspection. Disconnect the HT lead from the spark plug.
- Always wear heavy-duty gloves when repairing the cutting attachment. This is extremely sharp and can easily cause cuts.



- Store the machine out of reach of children.
- Use only original spare parts for repairs.

Basic working techniques

- Work with a swinging action from the bottom upwards when trimming sides.
- Adjust the throttle setting to suit the load.
- When trimming a hedge the engine should always face away from the hedge.
- Do not try to cut anything that is too thick for the blade.
- Do not try to cut hedges which are above your normal reach. You must hold the trimmer with both hands at all times while operating.

- Hold the machine as close to your body as possible to get the best balance.

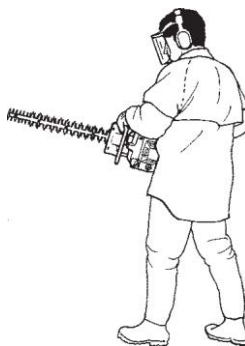

- Make sure that the tip does not touch the ground.
- Do not rush the work, but work steadily until all the branches have been cut back cleanly.

The hedge trimmer's rear handle can be set in five positions by pulling out the catch. See figure. When the handle is adjusted, the hedge trimmer must be idling or not running.



- While working the handle should always be facing upwards irrespective of how the hedge trimmer is directed.

MAINTENANCE



Before proceeding to adjust or repair the machine, be sure to stop the engine and detach the spark plug.

After the engine has stopped, the muffler is still hot.

Muffler

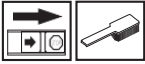

CAUTION! Some mufflers are fitted with a catalytic converter. See chapter on Technical data to see whether your machine is fitted with a catalytic converter.

The muffler is designed to reduce the noise level and to direct the exhaust gases away from the operator. The exhaust gases are hot and can contain sparks, which may cause fire if directed against dry and combustible material.

CAUTION! Never use a machine with a defective muffler.



WARNING! Mufflers fitted with catalytic converters get very hot during use and remain so for some time after stopping. This also applies at idle speed. Contact can result in burns to the skin. Remember the risk of fire!

Cooling system



To keep the working temperature as low as possible the machine is equipped with a cooling system.

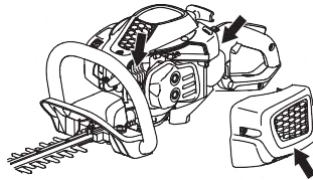

The cooling system consists of:

- 1 Cooling fins on the cylinder.
- 2 Cylinder cover (directs cold air over the cylinder).
- 3 Air intake through the crankcase (inside the tank).

Clean the cooling system with a brush once a week, more often in demanding conditions. A dirty or blocked cooling system results in the machine overheating which causes damage to the piston and cylinder.

Spark plug



The spark plug condition is influenced by:

- Incorrect carburettor adjustment.
- An incorrect fuel mixture (too much or incorrect type of oil).
- A dirty air filter.

These factors cause deposits on the spark plug electrodes, which may result in operating problems and starting difficulties.

MAINTENANCE

If the machine is low on power, difficult to start or runs poorly at idle speed: always check the spark plug first before taking any further action. If the spark plug is dirty, clean it and check that the electrode gap is 0.5 mm. The spark plug should be replaced after about a month in operation or earlier if necessary.

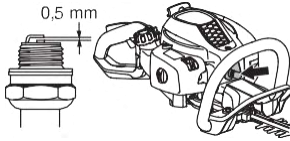

CAUTION! Always use the recommended spark plug type! Use of the wrong spark plug can damage the piston/cylinder. Check that the spark plug is fitted with a suppressor.

Air filter

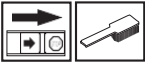

The air filter must be regularly cleaned to remove dust and dirt in order to avoid:

- Carburettor malfunctions
- Starting problems
- Loss of engine power
- Unnecessary wear to engine parts.
- Excessive fuel consumption.

Clean the filter every 25 hours, or more regularly if conditions are exceptionally dusty.



Cleaning the air filter

Remove the air filter cover and take out the **mesh** filter. Wash it clean in warm, soapy water. Allow the filter to dry and then oil it in according to the instructions.

An air filter that has been in use for a long time cannot be cleaned completely. The filter must therefore be replaced with a new one at regular intervals. **A damaged air filter must always be replaced.**

Oiling the air filter



The filter oil contains a solvent to make it spread evenly through the filter. You should therefore avoid skin contact. Put the filter in a plastic bag and pour the filter oil over it. Knead the plastic bag to distribute the oil. Squeeze the excess oil out of the filter inside the plastic bag and pour off the excess before fitting the filter to the machine. Never use common engine oil. This would drain through the filter quite quickly and collect in the bottom.

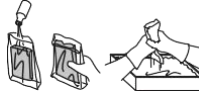

Gear



There is a plug for filling lubricant on the gear housing. Use the grease tube to fill with grease and repeat every 25 hours.

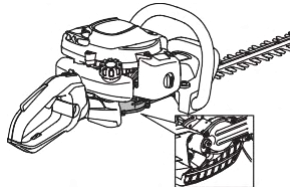

CAUTION! The gear housing must not be filled completely with grease. The grease expands as the machine heats up during operation. If the gear housing was completely filled with grease it could damage the seals and lead to leakage of grease.

The grease in the bevel gear does not normally need to be changed except if repairs are carried out.

Cutting unit

Check that the cutting units' screws are fitted correctly. Tighten them with a tightening torque of 7-10 Nm.

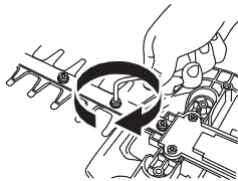

Cleaning and lubrication



Check that the blade edges are not damaged or deformed. File away any burrs.

Check that the blades move freely.

Storage

After the engine has stopped, the muffler is still hot. Never place the machine in any places where there are flammable materials (dry grass, etc), combustible gases or combustible liquids.

- Store in a cool, dry place away from sources of ignition and varying changes in temperature.
- Do not store a machine that has not been given time to fully cool down. Engine must be cooled down fully before storage.
- DO NOT stack other items on top of the machine when in storage.
- DO NOT store the machine with fuel in the tank in an area where the fuel vapours could reach an open flame, a strong heat source or a spark.
- Store the machine in a safe place, out of the reach of children.
- To reduce fire hazard keep engine and silencer free of debris, leaves, or excessive lubricant;
- Spray the cutting blades with a light oil to prevent rust before storage.

MAINTENANCE

Maintenance schedule

The following is a list of the maintenance that must be performed on the machine. Most of the items are described in the Maintenance section. The user must only carry out the maintenance and service work described in this Operator's Manual. More extensive work must be carried out by an authorized service workshop.

Maintenance	Before use:	After 40 hours in use	After 100 hours in use
Clean the outside of the machine.	After each time the machine is used		
Make sure the throttle trigger lock and the throttle function correctly from a safety point of view.	X		
In order to reduce the risk of fire, dirt, leaves and surplus lubricant, etc must be cleaned from the muffler, exhaust pipe and engine.	X		
Check that the stop switch works correctly.	X		
Check that the blades do not move when the engine is idling.	X		
Check that the blades are undamaged and show no signs of cracking or other damage. Replace the blades if necessary.	X		
Check that the blade guard is not damaged or distorted. Replace the blade if the blade guard is bent or damaged.	X		
Replace the cutting unit if it is bent or damaged.	X		
Check that the hand guard is not damaged. Replace the guard if damaged.	X		
Check that nuts and screws are tight.	X		
Check that there are no fuel leaks from the engine, tank or fuel lines.	X		
Clean the air filter and oil it in. Clean more often if conditions are exceptionally dusty.	(25 tim).		
Check the starter and starter cord.		X	
Check that the vibration damping elements are not damaged.		X	
Clean the outside of the spark plug. Remove it and check the electrode gap. Adjust the gap to 0.5 mm or replace the spark plug. Check that the spark plug is fitted with a suppressor.		X	
Clean the machine's cooling system.		X	
Clean the outside of the carburettor and the space around it.		X	
Fill the gear housing with grease. This should be carried out approximately every 25 working hours.		X	
Check that the screws that hold the blades together are correctly tightened.		X	
Check and clean the spark arrestor mesh on the muffler (only applies to mufflers fitted with a catalytic converter).		X	
Clean the inside of the fuel tank.			X
Check the inside of the fuel filter for any dirt or if the fuel hose has any cracks or other defects. Replace if necessary.			X
Check all cables and connections.			X
Check the clutch, clutch springs and the clutch drum for wear. Replace if necessary by an authorized service workshop.			X
Replace the spark plug. Check that the spark plug is fitted with a suppressor.			X

TECHNICAL DATA

Model	HYHT2600X
Remote Type	Centrifugal Clutch
Max. Number of Idle Reciprocating Motion Of Blades / Engine Speed	1725/9200rpm
Idle Speed Of Engine	3000±300rpm
Vibration Values At Each Handle ahv,eq (m/s ²)	Front Handle 0.513m/s ² Rear Handle 0.55m/s ² Uncertainty K=1.5m/s ²
Sound Pressure Values	LPA, Id = 86dB(A), Uncertainty K=3dB(A) LPA, Ra = 106dB(A), Uncertainty K=3dB(A)
Sound Power Values	LWA, Id= 87dB(A), Uncertainty K=3dB(A) LWA, Ra=104dB(A), Uncertainty K=3dB(A)
Guaranteed Sound Power Level According To 2000/14/EC & 2005/88/EC	107dB(A)
Blade Spacing	35mm
Length Of Blade	605mm
Weight	5.5kg
Engine Type	Air-Cooled, 2-Stroke
Displacement	25.4cc
Max. Output	0.7kW / 7000rpm
Carburettor	Diaphragm-Type
Ignition	Contactless Electronic Ignition
Starting Method	Recoil
Fuel Type	Pre-Mixed Unleaded Petrol
Fuel Tank Capacity	300ml
Fuel/Oil Ratio	40:1

Recycling & Disposal

We do not offer a takeback scheme for the recovery of Waste Electrical Electronic Equipment (WEEE) & Batteries. Instead the responsibility to dispose of WEEE and or Batteries is passed onto you by us.

So when it becomes necessary to dispose of your machine you must take it to your local Civic Amenity Site. For further information please contact your local Authority for disposal advice.

You MUST make sure that all unused oil and fuel is disposed of correctly either beforehand or at your local Civic Amenity Site.

Under NO circumstances must any fuel or oil be put down any drains.

Certain products contain WEEE waste which should not be disposed of in your domestic waste.

You MUST recycle WEEE in accordance with your local authority or recycling centre.

Certain products contain batteries which should not be disposed of in your domestic waste.

You MUST recycle batteries in accordance with your local authority or recycling centre.

Unwanted packaging and materials should be stored and taken to a recycling centre so it can be disposed of in a manner which is compatible with the environment.

We are a Member of the VALPAK National Compliance Scheme and our registration number is RM08660

For further information about disposal please contact your Local Authority.

You can also get more advice and guidance about recycling at the following website
<http://www.recycle-more.co.uk>

Should you pass this product on to another user either sold or loaned, you MUST pass on this user manual. This will make sure that all other users can use and maintain this machine safely.

Environmental Protection

1. Environmental protection should be a priority of considerable importance when using the machine, for the benefit of both social coexistence and the environment in which we live. Try not to cause any disturbance to the surrounding area.

2. You must comply with local regulations and provisions for the disposal of packaging, oils, petrol, filters, damaged parts or any elements which have a strong impact on the environment. This waste must not be disposed of as normal waste. It needs to be separated and taken to specified waste disposal centres where the material will be recycled.

3. You must comply with local regulations for the disposal of waste materials after mowing.

4. When disposing, do not pollute the environment with the machine, but hand it over to a disposal centre, in accordance with the local laws in force.

USEFUL INFORMATION

Our YouTube Channel

Our videos on YouTube include:

- Unboxing
- Assembly of your machine
- How to service your machine
- Products in use
- 'How To' videos
- Product features

Go to www.hyundaipowerproducts.co.uk or search 'Hyundai Power Products' in YouTube.

Warranty

For warranty information, please visit www.hyundaipowerproducts.co.uk

Proof of purchase will be required before you make a warranty claim.

Manual Updates

Our manuals are constantly being reviewed and updated. Should you find an error, omission or something unclear, please contact us for assistance.

We reserve the right to make any modifications without prior notice whenever necessary.

Our latest manuals are also placed online. All manuals can be downloaded at www.hyundaipowerproducts.co.uk

Returning Your Product

If you are returning your product, please contact the dealer for their returns policy.

Leaving A Review

We work very hard to give all of our customers the best possible service.

If you have any problems, before leaving negative feedback, please contact us to give us a chance to resolve the issue.

We would be delighted if you left us positive feedback!

To leave a review, please go to: uk.trustpilot.com/review/hyundaipowerequipment.co.uk

Ordering Spare Parts

Only use original spare parts. The use of non-original and/or incorrectly fitted parts will jeopardize the safety of the machine, may cause accidents or personal injuries for which the manufacturer is under no circumstance liable or responsible.

Contact Us

Our friendly aftersales team will be more than happy to help you.

Phone

Call our team on 01646 687 880, open Monday-Friday 8.30am-5pm.

Email

aftersales@hyundaipowerproducts.co.uk

Online Live Chat

Go to www.hyundaipowerproducts.co.uk
Live chat is open Monday-Friday from 8.30am-5pm.

Post

Genpower Ltd, Isaac Way, Pembroke Dock,
Pembrokeshire. SA72 4RW, UK.

DECLARATION OF CONFORMITY

EC Declaration of Conformity

We hereby declare that the machine detailed in this declaration complies to all the relevant provisions of the following EC directives.

- 2006/42/EC The Machinery Directive
- 2014/30/EU Annex II Electromagnetic Compatibility Directive
- 2016/1628/EC The Emission of Gaseous and Particulate Pollutants from internal Combustion engines
- 2000/14/EC Noise Emissions in the Environment by Equipment for use Outdoors.

And is in conformity with the applicable requirements of the following documents:

- EN ISO 11806-1:2011
- EN ISO 10517:2019

Declaration for 2000/14/EC Noise Emissions in the Environment by Equipment for use Outdoors.

Notified Body for EC Directive 2000/14/EC TÜV Rheinland (Shanghai) Co., Ltd.

Model	Type	Engine Size	Measured Sound Power	Guaranteed Sound Power	Engine output
HYHT2600X	Hedge Trimmer	25.4cc	95dB(A)	107dB(A)	0.65kW

Product Details

Brand: Hyundai

Model: HYHT2600X

Description: Petrol Hedge Trimmer

Name and address of technical documentation holder and EU distributor:

Genpower Ltd, Isaac Way, Pembroke Dock, Pembrokeshire, SA72 4RW, UK.

Signed by: 

Roland Llewellyn, Managing Director

Date: 08/04/2020

HYUNDAI

POWER PRODUCTS

Importer:

GENPOWER LTD

Isaac Way, London Road

Pembroke Dock, UNITED KINGDOM, SA72 4RW

T: +44 (0) 1646 687 880 F: +44 (0) 1646 686 198

E: info@hyundaipowerproducts.co.uk

www.hyundaipowerproducts.co.uk

Licensed by Hyundai Corporation, Korea

