

Maestro® Occupancy/Vacancy Sensor C•L® Dimmer Additional Programming, Installation, and Troubleshooting Help

Maestro® Occupancy/Vacancy Sensor C•L® Dimmer Models

MSCL-OP153M; MSCL-OP153MH; MSCL-VP153M; MSCL-VP153MH

Overview

This document serves as a supplement to the Maestro® Occupancy/Vacancy Sensor C•L® Dimmer instruction sheet.

Maestro® Sensor Dimmer

Indicator Lights (IL) 1–7

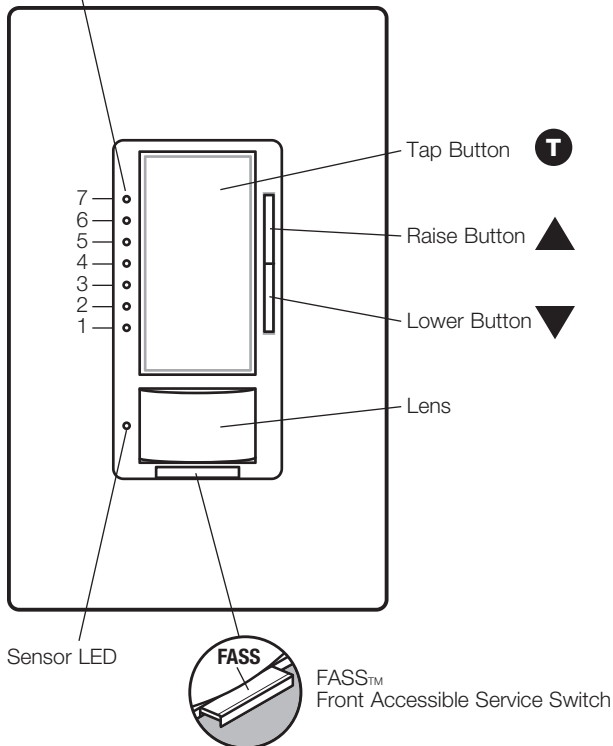

Glossary	2
Sensor Coverage	3
Sensor Features in Programming Mode	4
Dimming Features in Advanced Programming Mode	6
Programming Mode	7
Timeout	7
Sensitivity	8
Auto-ON	8
Occupied Level.	8
Advanced Programming Mode	9
Preset Light Level	10
Manual Fade ON Time	12
Manual Fade OFF Time	13
Delayed Fade to OFF.	14
Nightlight Mode	15
Low-End Trim	16
Low-End Trim Shortcut	16
High-End Trim	17
Restoring Default Settings	18
Two-Location Applications Using an Existing Switch	19
Ambient Light Detection (ALD).	21
How it Works.	21
FAQs	21
Troubleshooting	22
Bulb Compatibility	24

Notes:

- To replace fixture bulb(s), power may be temporarily disconnected at the light fixture by pulling the FASS™ OUT on the dimmer.
- For any procedure other than routine bulb replacement, power MUST be disconnected at the main electrical panel.



Glossary

- Auto-ON** Setting to adjust how the dimmer responds to initial occupancy of the room.
- Auto-ON: ALD** Setting in which the dimmer turns ON upon initial occupancy of the room *only* if there is *not* enough ambient light. Based on the user's interactions with the **T** button, the Maestro® Sensor Dimmer will learn the user's preference for when it should turn ON once motion is detected. (Also called *Ambient Light Detect* mode.)
- Auto-ON: Disabled** Setting where the dimmer will turn ON *only* when the **T** button is pressed, but will still turn OFF automatically when the room is vacated. (Also called *Vacancy* mode.)
- Auto-ON: Enabled** Default setting for the Maestro® Sensor Dimmer. The sensor automatically turns ON upon initial occupancy of the room, and turns OFF when the room is vacated. (Also called *Occupancy* mode.)
- Auto-ON: OWO** Setting in which the lights remain OFF even as the room continues to be occupied. (Also called *OFF-While-Occupied* mode.)
- Default Setting** Original preset options to which the dimmer is programmed before initial use.
- FASS™** Front Accessable Service Switch is the tab at bottom of Maestro® Sensor Dimmer, required to be pulled out before replacing light bulb(s) and entering all programming modes. (Also called *Air Gap*.)
- High-End Trim** An adjustable feature that allows the user to set the brightest achievable light level in the dimmer.
- Indicator Lights (ILs)** LEDs on dimmer that show current light level and are also used to indicate programming status.
- Low-End Trim** Dimmest stable light level to which the dimmer can be adjusted.
- Load** The light bulb(s) that the dimmer is controlling.
- Locked Preset** A programmable light level to which the dimmer will illuminate with a single press of the **T** button.
- Occupied Level** A programmable light level to which the dimmer will illuminate once occupancy has been detected.
- Occupied Level: 100%** The default set point for occupied level in which the Maestro® Sensor Dimmer turns ON all lights to 100% of the dimmable light level.
- Occupied Level: 50%** The setting in which the Maestro® Sensor Dimmer turns ON all lights to 50% of their dimmable light level.
- Occupied Level: Preset** Setting in which the Maestro® Sensor Dimmer achieves a customized light level when the **T** button is pressed.
- Sensitivity** Setting to adjust the level of motion needed to trigger the Maestro® Sensor Dimmer.
- Sensor LED** LED that glows when motion is detected; positioned next to Maestro® Sensor Dimmer lens.
- Test Mode** A temporary, short timeout (less than 15 seconds) that can be used to test the Maestro® Sensor Dimmer coverage while in the Programming Mode.
- Timeout** Setting that determines how long the lights will remain ON after motion is no longer detected.
- Unlocked Preset** Setting in which a single press of the **T** button turns the dimmer ON to the last light level.

Maestro® Sensor Dimmer Coverage Area

NEMA WD7 Test Grid Coverage (High Sensitivity Setting)

 Major motion coverage: 900 ft² (81 m²)

 Minor motion coverage: 400 ft² (36 m²)

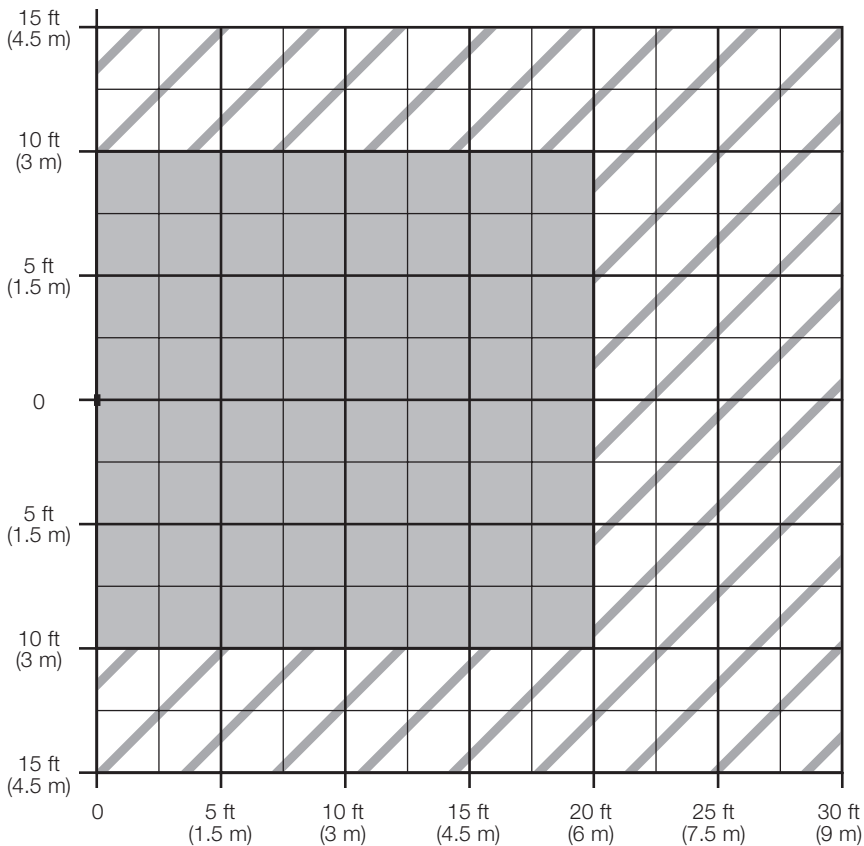

Horizontal Beam Diagram (for reference only)

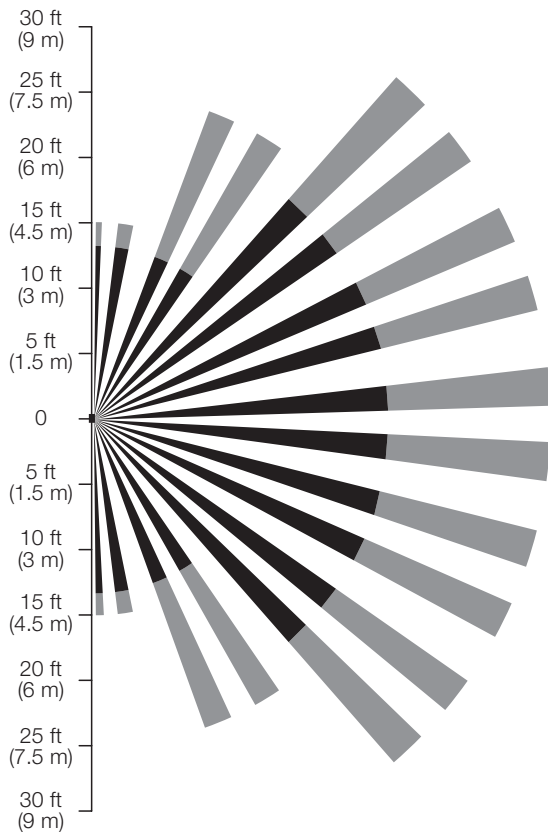

Vertical Beam Diagram

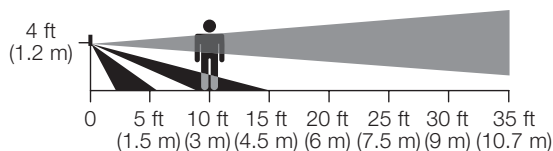

- Test Room Dimensions: 37 ft × 38 ft (11.28 m × 11.6 m)
- Test Floor Surface Material: Carpet
- Sensor Coverage Angle: 180°
- Major motion coverage: Initial trigger motion detection
- Minor motion coverage: Maintained motion detection



Maestro® Sensor Dimmer Features in Programming Mode

This Maestro® Sensor Dimmer has features that allow you to customize the unit to achieve your individual needs. The following is an overview of these features:

- Timeout
- Sensitivity
- Auto-ON
- Occupied Level

Note: *Programming Mode* instructions can be found on pages 6 and 7.

Timeout

The approximate time in minutes after which the lights will turn OFF after the last motion is detected. The default setting timeout is 5 minutes but can be adjusted to 1, 3, 15, or 30 minutes.

What Timeout Setting do I want?

Shorter timeouts are best in areas where occupants are generally moving around. Laundry rooms, foyers, kitchens, and closets are typically good applications for shorter timeouts. Longer timeouts are better for areas where occupants move less frequently, such as in an office. Using a timeout of 15 minutes or more may increase bulb life in fluorescent bulbs. Consider using a longer timeout if you are controlling a dimmable CFL.

Sensitivity

The setting determines how sensitive the PIR sensor will be. Lowering the sensitivity will cause the Maestro® Sensor Dimmer to respond only to larger movements.

- **High Sensitivity:** This is the most sensitive setting and will detect very slight motions. This is the recommended setting because it will work well for nearly all applications.
- **Low Sensitivity:** This is the least sensitive setting and can be used in areas of major or large motions.

What Sensitivity Setting do I want?

High sensitivity is typically the best setting. If the Maestro® Sensor Dimmer is turning on too often due to unintended interference from the environment (e.g., heating or cooling vents near the Maestro® Sensor Dimmer, moving draperies), low sensitivity may be selected.

Continued on next page...

Maestro® Sensor Dimmer Features in Programming Mode (continued)

Auto-ON (Occupancy Version only)

The automatic functionality of the Maestro® Sensor Dimmer can be adjusted to control how the lights respond upon initial occupancy. There are four available *Auto-ON* settings: *Enabled*, *Disabled*, *Ambient Light Detect (ALD)*, and *OFF-While-Occupied (OWO)*. The default setting is *Enabled*.

- **Auto-ON: Enabled:** The lights will always turn ON when occupancy is detected.
 - When the user manually turns OFF the light, the light will remain OFF for 25 seconds. After this time, the Maestro® Sensor Dimmer will turn lights ON if motion is detected.
- **Auto-ON: Disabled:** This setting converts the Maestro® Sensor Dimmer to *Vacancy* mode. The lights will not automatically turn ON but will still automatically turn OFF after vacancy. The lights must be manually turned ON by pressing the **T** button on the dimmer or switch.
- **Auto-ON: Ambient Light Detect (ALD) Mode:** The lights will turn ON when occupancy is detected and ambient light is too low. If lights turn ON when there is enough natural light, press the **T** button within 5 seconds of entering the room. If lights do not turn ON when there is not enough natural light, press the **T** button within 5 seconds of entering the room. Over time, this interaction will “teach” the Maestro® Sensor Dimmer your preferred setting.
- **Auto-ON: OFF-While-Occupied (OWO) Mode:** The lights will always turn ON when occupancy is detected. If lights are manually turned OFF, Maestro® Sensor Dimmer will keep lights OFF as long as room is occupied.

What Auto-ON Setting do I want?

- If you want the lights to automatically turn ON when someone enters the room, the *Auto-ON* setting should remain enabled.
- If you want the lights to turn ON automatically when someone enters the room, but also want the dimmer to keep the lights OFF after it has been manually turned OFF, you should select *OFF-While-Occupied* mode.
- If you want the lights to turn ON only when the **T** button is pressed, choose *Auto-ON: Disabled*. This is *Vacancy* mode, and the unit will turn OFF automatically only when occupancy is no longer detected. Bedrooms are a typical application where the *Auto-ON* feature should be *Disabled*.
- If you want the lights to remain OFF when there is already enough ambient light in the room, *Ambient Light Detect* mode should be *Enabled* to maximize energy savings. The user(s), upon entering the room, must be prepared to correct the dimmer with the **T** button if the lights do not respond as expected.

Occupied Level

This setting determines how much light will be automatically turned ON when motion is detected.

Default Setting: 100%

- **100%:** The lights will always turn on to 100% of the dimmable light level.
- **50%:** The lights will always turn on to 50% of the dimmable light level.
- **Preset:** The lights will turn ON to the last level that was used on the Maestro® Sensor Dimmer. If you select a *Locked Preset* in *Advanced Programming Mode*, you will be able to lock this light level so that other adjustments will not change this preset

What Occupied Level Setting do I want?

- *Preset* mode allows for full customization of preferred light level.
- 100% will ensure that the lights are turned on to the brightest level available upon entering a room.
- 50% is the default light level for manual operation of Maestro® products. To synchronize the default setting levels of all Maestro® products in the house, this is the best choice.

Dimming Features in Advanced Programming Mode¹

The Maestro® Sensor Dimmer has features that allow the user to change aspects of the dimming functionality. The features include:

Preset Light Level

- Set the light level that the lights turn ON to after a single press of the **T** button.
- Lock your preset to save your setting when using *Occupied Level: Preset* mode

Manual Fade ON Time

- Set how quickly the lights will fade up to ON after a single press of the **T** button.

Manual Fade OFF Time

- Set how quickly the lights will fade down to OFF after a single press of the **T** button.

Delayed Fade to OFF²

- Set to increase or decrease the delay of the *Delayed Fade to OFF* feature.

Enable/Disable Nightlight Mode

- Set the Indicator LEDs to glow or stay OFF when the lights in the room are OFF.

Low-End Trim³

- Set your minimum available light level during normal operation.

High-End Trim

- Set your maximum available light level during normal operation.

¹ *Advanced Programming Mode* instructions can be found on pages 8–16.

² *Delayed Fade to OFF Time* instructions can be found on page 14.

³ Raising the Low-End Trim on your dimmer may improve bulb performance for CFLs or LEDs.

Programming Mode

Enter *Programming* mode to change the settings on your Maestro® Sensor Dimmer.

Note: Once a feature is modified, the setting is immediately saved.

Enter Programming Mode

(see picture at right)

1. Pull the FASS™ toward you into the OFF position.
2. Press and hold the **T** button of the product you are programming.
3. Push the FASS™ away from you into the ON position while continuing to hold the **T** button for approximately 5 seconds until IL 1 blinks quickly.
4. Continue programming: Go to *Main Sensor Menu* section below.

Note: If there is no activity for 1 minute, the Maestro® Sensor Dimmer will exit *Programming* mode automatically.

Main Sensor Menu

1. Press the ▲ or ▼ button to position the glowing IL next to the feature you want to modify:
 - IL #7 Advanced Programming Mode
 - IL #4 Occupied Level
 - IL #3 Auto-ON (occupancy version only)
 - IL #2 Sensitivity
 - IL #1 Timeout
2. Press the **T** button one time to select that feature.
3. Go to the appropriate selection menu, starting below, to continue programming.

Selection Menu: Timeout

Once you've selected *Timeout* from the *Main Sensor Menu*, proceed with the following steps.

In the *Timeout* Menu

1. Press the ▲ or ▼ button to move the blinking IL to desired *Timeout* duration.
2. Press the **T** button one time to set the *Timeout* duration and return to the *Main Sensor Menu*.
Default Setting: 5 minutes.

To Exit any mode or programming step:

- Press and hold the **T** button for 5 seconds or
- Pull the FASS™ out, then push the FASS™ back in or
- Wait for 1 minute

Programming Mode

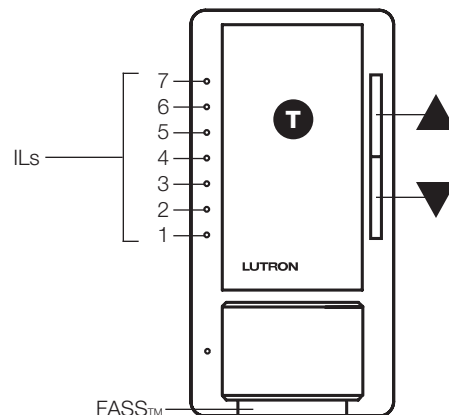

Main Sensor Menu

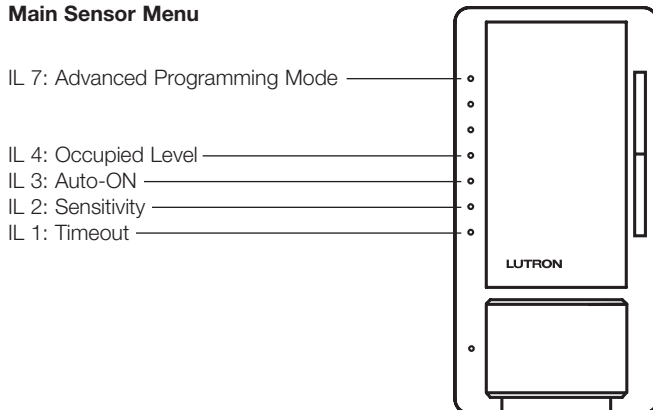

Selection Menu: Timeout

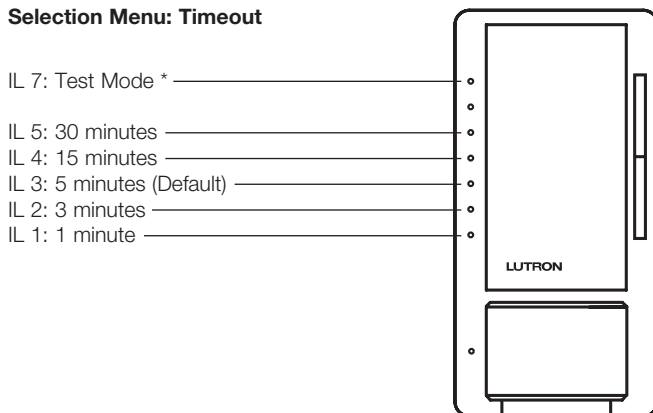

* *Test Mode* is a temporary, short timeout (less than 15-seconds) that can be used to test the Maestro® Sensor Dimmer coverage. After entering *Test Mode*, the device will exit *Test Mode* automatically after 5 minutes, or when any button is pressed. If no motion is detected, the lights will turn OFF. If motion is detected, the lights will turn ON and continue to stay ON for as long as motion is detected. The sensor LED will flash when motion has been detected.

Continued on next page...

Programming Mode (continued)

Selection Menu: Sensitivity

Once you've selected *Sensitivity* from the *Main Sensor Menu*, proceed with the following steps.

In the *Sensitivity* Menu

1. Press the ▲ or ▼ button to move the blinking IL to desired sensitivity.
2. Press the **T** button one time to set the *Sensitivity* level and return to the *Main Sensor Menu*.

Default Setting: *High* sensitivity.

Selection Menu: Sensitivity

- IL 2: High (Default)
- IL 1: Low

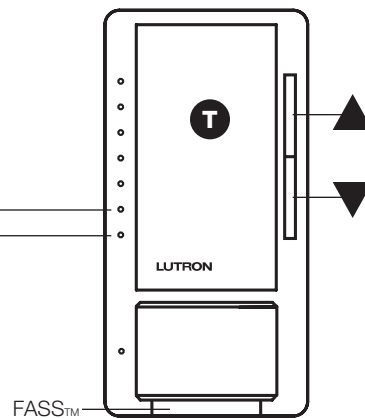

Selection Menu: Auto-ON

(Occupancy Version, MSCL-OP153M, Only)

Once you've selected *Auto-ON* from the *Main Sensor Menu*, proceed with the following steps.

In the *Auto-ON* Menu

1. Press the ▲ or ▼ button to move the blinking IL to desired *Auto-ON* setting.
2. Press the **T** button one time to set the *Auto-ON* setting and return to the *Main Sensor Menu*.

Default Setting: *Auto-ON Enabled*.

Selection Menu: Auto-ON

- IL 4: OFF-While-Occupied
- IL 3: Ambient Light Detect
- IL 2: Disabled
- IL 1: Enabled (Default)

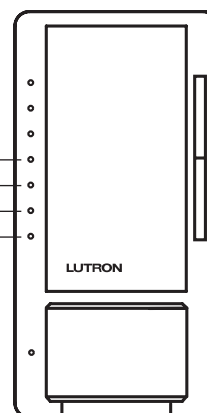

Selection Menu: Occupied Level

Once you've selected *Occupied Level* from the *Main Sensor Menu*, proceed with the following steps.

In the *Occupied Level* Menu

1. Press the ▲ or ▼ button to move the blinking IL to desired *Occupied Level*.
2. Press the **T** button one time to set the *Occupied Level* and return to the *Main Sensor Menu*.

Default Setting: *100%*.

Selection Menu: Occupied Level

- IL 7: 100% (Default)
- IL 4: 50%
- IL 1: Preset

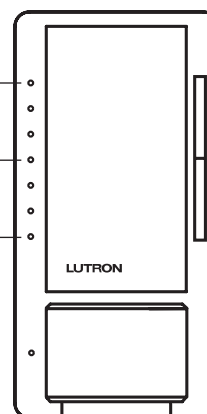

To Exit any mode or programming step:

- Press and hold the **T** button for 5 seconds or
- Pull the *FASS™* out, then push the *FASS™* back in or
- Wait for 1 minute

Advanced Programming Mode

Enter Advanced Programming Mode (APM)

1. While in *Main Sensor* menu, **press** the ▲ or ▼ button until IL 7 is blinking.
2. **Press** the **T** button **one time** to enter the *APM* menu.

Selection Menu: Advanced Programming Mode

1. While in *APM* menu, **press** the ▲ or ▼ button to **position** the slowly blinking IL next to the feature you want to modify.
2. **Press** the **T** button **one time** to **select** that feature for modification.
3. Go to the appropriate section starting on page 10 to continue programming.

Note:

- If there is no button activity for 1 minute, the dimmer will automatically exit *APM* and return to *Normal Operation*.

Main Sensor Menu

IL 7: Advanced Programming Mode

IL 4: Occupied Level

IL 3: Auto-ON

IL 2: Sensitivity

IL 1: Timeout

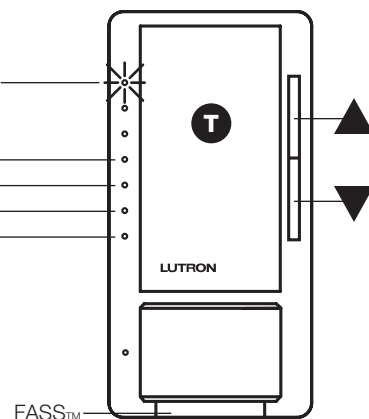

Selection Menu: Advanced Programming Mode

IL 7: High-End Trim

IL 6: Low-End Trim

IL 5: Nightlight Mode

IL 4: Delayed Fade to OFF Time

IL 3: Manual Fad OFF Time

IL 2: Manual Fad ON Time

IL 1: Preset Light Level

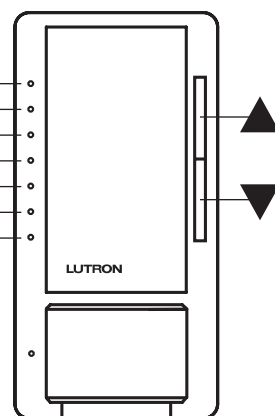

To Exit any mode or programming step:

- **Press and hold** the **T** button for 5 seconds
- or
- **Pull** the *FASS™* out, then **push** the *FASS™* back in
- or
- **Wait** for 1 minute

Continued on next page...

Advanced Programming Mode (continued)

Programming Option 1: Preset Light Level

What it Does

Presets the dimmer to achieve a certain light level when the **T** button is pressed. If you prefer that the dimmer retains the same light level every time you turn it ON, choose the *Locked Preset*. If you prefer that the dimmer returns to the light level previously used when you turn it ON, choose the *Unlocked Preset* setting.

Note: Double-tapping the **T** button in *Normal Operation* mode will always bring the light level to maximum intensity.

Settings

There are two settings in *Option 1: Preset Light Level*.

Locked Preset

When programmed for a *Locked Preset*, the dimmer will always turn on to the predetermined *locked* level anytime the dimmer is turned on with a single tap of the **T** button. If you want occupancy detection to turn on your lights to this locked preset, set your *Occupied Level* to *Preset* per the instructions on page 7.

Unlocked Preset

When programmed for an *Unlocked Preset*, the dimmer will turn on to the light level to which it was previously adjusted.

Default Setting

Unlocked Preset (no ILs ON)

Locked Preset Directions

1. Enter Preset Light Level Menu: While in *APM*, press the **▲** or **▼** button to select the first option, *Programming Option 1: Preset Light Level*. Once IL 1 is blinking, press the **T** button; the IL will switch to the current setting and begin to blink rapidly or turn OFF.
2. Select Desired Locked Preset Light Level: Press the **▲** or **▼** button to choose desired room light intensity. The room light will become brighter or dim, reflecting the *Locked Preset* level as the feature is adjusted.
3. Press the **T** button one time to set the *Preset Light Level* and return to the *APM* main menu.

Note:

- If there is no button activity for 1 minute, the dimmer will automatically exit *APM* and return to *Normal Operation*.

Preset Light Level Menu

IL 7: Brightest
IL 6
IL 5
IL 4
IL 3
IL 2
IL 1: Dimmest

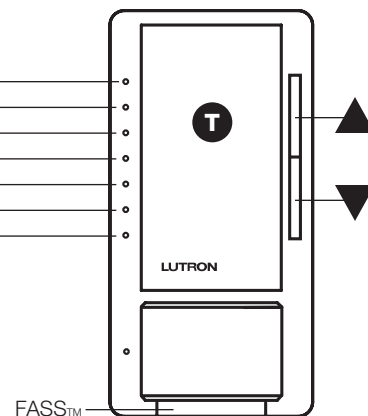

To Exit any mode or programming step:

- Press and hold the **T** button for 5 seconds
or
- Pull the *FASS™* out, then push the *FASS™* back in
or
- Wait for 1 minute

Continued on next page...

Advanced Programming Mode (continued)

Programming Option 1: Preset Light Level (continued)

Unlocked Preset Directions

To **deactivate** a *Locked Preset* setting so that the dimmer will turn on to the light level to which it was last set while in *Normal Operation*, the *Unlocked Preset* must be activated.

1. **Enter Preset Light Level Menu:** While in *APM*, **press** the ▲ or ▼ button **to select** the first option, *Programming Option 1: Preset Light Level*. Once IL 1 is blinking, **press** the **T** button; the IL will switch to the current setting and begin to blink rapidly or turn OFF.
2. **Select Unlocked Preset:** **Press** the ▼ button until IL 1 is quickly flashing. **Release** the ▼ button and **press and hold** the ▼ button again for approximately 3 seconds or until all ILs turn OFF.

Note: The light will remain at its minimum output when you perform this action.

3. **Press** the **T** button **one time to set** the *Preset Light Level* and return to the *APM* main menu.

Note:

- If there is no button activity for 1 minute, the dimmer will automatically exit *APM* and return to *Normal Operation*.

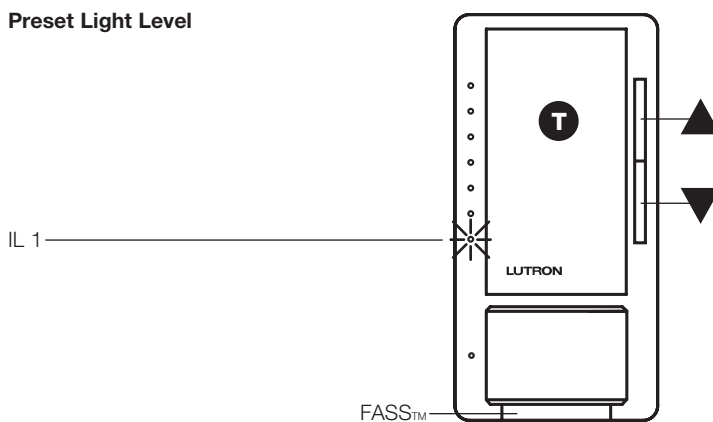

To Exit any mode or programming step:

- **Press and hold** the **T** button for 5 seconds
- or
- **Pull** the *FASS™* out, then **push** the *FASS™* back in
- or
- **Wait** for 1 minute

Continued on next page...

Advanced Programming Mode (continued)

Programming Option 2: Manual Fade ON Time

What it Does

Controls how quickly the lights will fade up when the dimmer is manually turned ON. If the light controlled by the dimmer is the first or only light that will be turned ON in a particular room, most people prefer to use a faster time so that the room is immediately illuminated. Art lighting or other accent lighting is often more pleasing with a slower fade time. The *Fade ON Time* adjustment applies when the **T** button is pressed manually. All occupancy-based fade times are fixed.

Settings

The settings include fade times from *OFF* to *Maximum Light Output* in as quickly as 0.75 seconds and as slowly as 15 seconds.

Default Setting

0.75 seconds (IL 1)

Directions

1. Enter Manual Fade ON Time Menu: While in *APM*, press the ▲ or ▼ button to select the second option, *Programming Option 2: Manual Fade ON Time*. Once IL 2 is blinking, press the **T** button.
2. Select Desired Manual Fade ON Time: Press the ▲ or ▼ button to select the desired *Manual Fade ON Time*. ILs 1–5 represent the different settings.
3. Press the **T** button one time to set the *Manual Fade ON Time* and return to the *APM* main menu.

Notes:

- The fade times while pressing either the ▲ or ▼ button during *Normal Operation* are not affected by any *Manual Fade ON Time* modification. These speeds are constant.
- The *Manual Fade ON Times* will be available only when the lights are turned ON using a Maestro® Sensor Dimmer or a Companion Dimmer; when using a mechanical switch in a 3-way application, the lights will fade ON and OFF at an accelerated rate.
- If there is no button activity for 1 minute, the dimmer will automatically exit *APM* and return to *Normal Operation*.

Manual Fade ON Time

- IL 5: 15 seconds
- IL 4: 5 seconds
- IL 3: 3 seconds
- IL 2: 2.5 seconds
- IL 1: 0.75 seconds (Default)

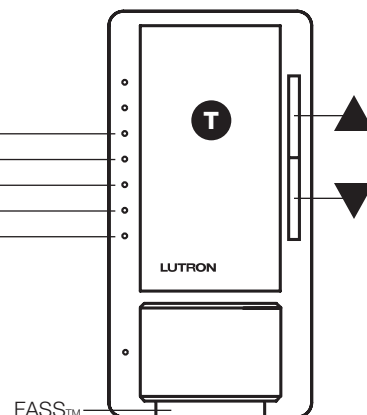

To Exit any mode or programming step:

- Press and hold the **T** button for 5 seconds
- or
- Pull the *FASS™* out, then push the *FASS™* back in
- or
- Wait for 1 minute

Continued on next page...

Advanced Programming Mode (continued)

Programming Option 3: Manual Fade OFF Time

What it Does

Controls how quickly the lights will fade down when the dimmer is turned OFF. A slower *Manual Fade OFF Time* is suggested for rooms the user wishes to exit while the lights still provide illumination. Be aware that the light dimming may not be immediately noticeable for settings of 5 seconds or longer. The *Fade OFF Time* adjustment applies when the **T** button is pressed manually. All occupancy-based fade times are fixed.

Settings

The settings include fade times from *Maximum Light Output* to OFF in as quickly as 0.75 seconds and as slowly as 15 seconds.

Default Setting

0.75 seconds (IL 1)

Directions

1. Enter Manual Fade OFF Time Menu: While in *APM*, press the ▲ or ▼ button to select the third option, *Programming Option 3: Manual Fade OFF Time*. Once IL 3 is blinking, press the **T** button.
2. Select Desired Manual Fade OFF Time: Press the ▲ or ▼ button to select the desired *Manual Fade OFF Time*. ILs 1–5 represent the different settings.
3. Press the **T** button one time to set the *Manual Fade OFF Time* and return to the *APM* main menu.

Notes:

- The fade times while pressing the ▲ or ▼ button during *Normal Operation* are not affected by any *Manual Fade OFF Time* modification. These speeds are constant.
- The *Manual Fade OFF Times* will be available only when the lights are turned ON using a Maestro® Sensor Dimmer or a Companion Dimmer. While using a mechanical switch in a 3-way application, the lights will fade ON and OFF at an accelerated rate.
- If there is no button activity for 1 minute, the dimmer will automatically exit *APM* and return to *Normal Operation*.

Manual Fade OFF Time

- IL 5: 15 seconds
- IL 4: 5 seconds
- IL 3: 3 seconds
- IL 2: 2.5 seconds
- IL 1: 0.75 seconds (Default)

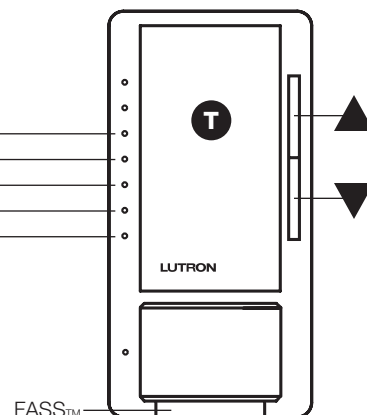

To Exit any mode or programming step:

- Press and hold the **T** button for 5 seconds
- or
- Pull the *FASS™* out, then push the *FASS™* back in
- or
- Wait for 1 minute

Continued on next page...

Advanced Programming Mode (continued)

Programming Option 4: Delayed Fade to OFF Time

What it Does

Controls how quickly/slowly the room lights start the dimming sequence after the **T** button is pressed. Longer *Fade to OFF Times* are suggested for use in large rooms where the light control is opposite the exit and immediate dimming is not wanted.

Settings

The settings included in the dimming sequence are from the time that the **T** button is pressed (*Normal Operation*) until the room lights begin the *Fade to OFF* process.

Default Setting

30 seconds (IL 3)

Directions

1. Enter Delayed Fade to OFF Time Menu: While in *APM*, press the ▲ or ▼ button to select the fourth option, *Programming Option 4: Delayed Fade to OFF Time*. Once IL 4 is blinking, press the **T** button.
2. Select Desired Delayed Fade to OFF Time: Press the ▲ or ▼ button to select the desired *Delayed Fade to OFF Time*. ILs 1–7 represent the different settings.
3. Press the **T** button one time to set the *Delayed Fade to OFF Time* and return to the *APM* main menu.

Notes:

- To initiate the Delayed Fade to OFF feature in *Normal Operation*, while the light is ON, press and hold the **T** button for one second and then release.
- If there is no button activity for 1 minute, the dimmer will automatically exit *APM* and return to *Normal Operation*.

Delayed Fade to OFF Time

- IL 7: 70 seconds
- IL 6: 60 seconds
- IL 5: 50 seconds
- IL 4: 40 seconds
- IL 3: 30 seconds (Default)
- IL 2: 20 seconds
- IL 1: 10 seconds

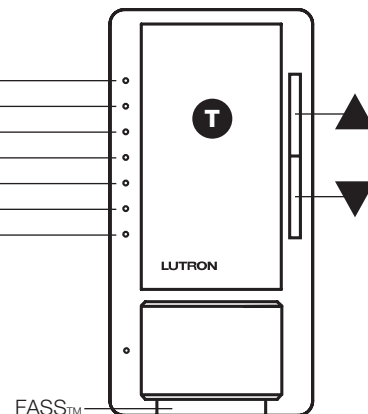

To Exit any mode or programming step:

- Press and hold the **T** button for 5 seconds
- or
- Pull the *FASS™* out, then push the *FASS™* back in
- or
- Wait for 1 minute

Continued on next page...

Advanced Programming Mode (continued)

Programming Option 5: Nightlight Mode

What it Does

When the Maestro® Sensor Dimmer is turned OFF and the light goes out, the ILs remain ON in a dim glow state, known as *Nightlight* mode. *Disabling Nightlight* mode is an energy-saving practice and also allows the dimmer to be compatible with a broader range of CFLs and LEDs. *Enabling Nightlight* mode provides a soft glow for easy location of the dimmer in a dark room.

Settings

Enable Nightlight Mode: ILs will glow when Maestro® Sensor Dimmer is OFF.

Disable Nightlight Mode: ILs will stay OFF when Nightlight Mode is OFF.

Default Setting

Nightlight Mode Enabled

Directions

1. Enter Enable/Disable Nightlight Mode Menu: While in *APM*, **press** the ▲ or ▼ button **to select** the fifth option, *Programming Option 5: Enable/Disable Nightlight Mode*. Once IL 5 is blinking, **press** the T button.
2. Select Enable/Disable Nightlight: Once in the menu, IL 4 will begin blinking rapidly. This indicates that *Nightlight Mode* is Enabled. Tapping the ▼ button will cause the IL to stop blinking. No ILs blinking indicates that *Nightlight Mode* is Disabled. **To enable Nightlight Mode**, **tap** the ▲ button so that IL 4 resumes rapid blinking.
3. **Press** the T button **one time to set** the *Enable/Disable Nightlight Mode* and return to the *APM* main menu.

Notes:

- It may be necessary to disable the ILs (*Nightlight* mode) when using certain CFL and LED bulbs to achieve best bulb performance.
- If there is no button activity for 1 minute, the dimmer will automatically exit *APM* and return to *Normal Operation*.

Enable/Disable Nightlight Mode

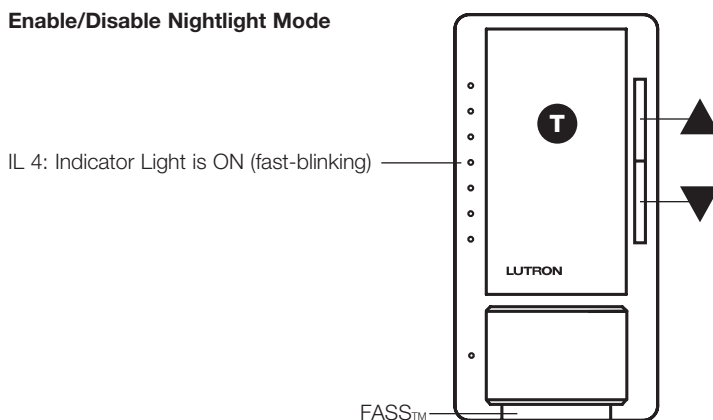

To Exit any mode or programming step:

- **Press and hold** the T button for 5 seconds
or
- **Pull** the *FASS™* out, then **push** the *FASS™* back in
or
- **Wait** for 1 minute

Continued on next page...

Advanced Programming Mode (continued)

Programming Option 6: Low-End Trim (See *Low-End Trim Shortcut* below)

What it Does

Eliminates LED and CFL bulb flickering and strobing when the dimmer is turned ON to the dimmest setting. This feature can also be used to set a personal preference for incandescent or halogen bulbs.

Settings

Some LED and CFL bulbs require a higher *Low-End Trim* than others. *Low-End Trim* allows the user to change the lowest dimmer light level based on bulb performance. *Low-End Trim* adjustment is required for LEDs and CFLs to optimize bulb performance and preserve bulb life.

Default Setting

IL 3

Directions (How to Program from APM)

1. Enter Low-End Trim Menu: While in APM, press the ▲ or ▼ button to select the sixth option, *Programming Option 6: Low-End Trim*. Once IL 6 is blinking, press the T button.
2. Select Desired Low-End Trim Level: Press the ▲ or ▼ button to select the desired *Low-End Trim* level. ILs 1–7 represent the different settings.
3. Press the T button one time to set the *Low-End Trim* and return to the APM main menu.

Note:

- While setting the *Low-End Trim*, observe the actual light (load) and not the ILs on the dimmer to determine the optimum setting.
- Incremental levels of light intensity exist within each IL setting, and the ▲ or ▼ button may have to be pressed several times to proceed to the next setting.

Notes:

- *Low-End Trim* adjustment is required for LEDs and CFLs; if not performed, the life of the LED/CFL bulb may be reduced.
- If there is no button activity for 1 minute, the dimmer will automatically exit APM and return to *Normal Operation*.

To Exit any mode or programming step:

- Press and hold the T button for 5 seconds or
- Pull the FASS™ out, then push the FASS™ back in or
- Wait for 1 minute

Low-End Trim

IL 7: Brightest Low-End
IL 6
IL 5
IL 4
IL 3: (Default)
IL 2
IL 1: Dimmest Low-End

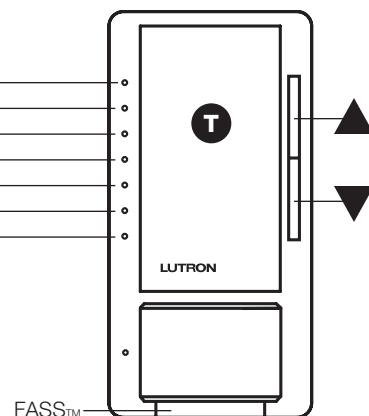

Low-End Trim Shortcut

For quick changes* to the *Low-End Trim*, this shortcut method bypasses the APM.

1. Press and hold the T and ▼ buttons until an IL blinks. The Load will turn OFF and then turn ON to Low-End.
2. Press the ▲ or ▼ button to adjust light output until it's stable and not flickering. Press and release the T button to save setting.
3. Press and release the T button to turn load OFF, then press the ▲ button once. If load does not turn ON or remains unstable, repeat Step 2, pressing the ▲ button to increase light level.

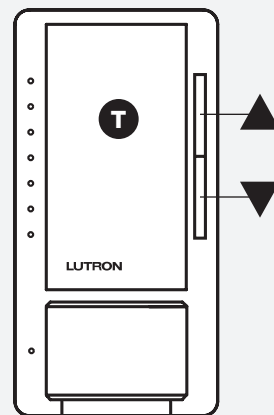

* It's not necessary to enter any Programming or APM modes.

Continued on next page...

Advanced Programming Mode (continued)

Programming Option 7: High-End Trim

What it Does

Some lamps require a lower *High-End Trim* than others. This feature allows the user to determine the maximum light level and adjust the settings accordingly. Lowering the *High-End Trim* can help save energy.

Settings

High-End Trim allows the user to choose the brightest achievable light level.

Default Setting

IL 7: Brightest High-End

Directions

1. Enter High-End Trim Menu: While in *APM*, press the ▲ or ▼ button to select the seventh option, *Programming Option 7: High-End Trim*. Once IL 7 is blinking, press the T button.
2. Select Desired High-End Trim Level: Press the ▲ or ▼ button to select the desired *High-End Trim* level. ILs 1–7 represent the different settings.

Note:

- While setting the *High-End Trim*, observe the actual light (load) and not the ILs on the dimmer to determine the optimum setting.
- Incremental levels of light intensity exist within each IL setting, and the ▲ or ▼ button may have to be pressed several times to proceed to the next setting.

3. Press the T button one time to set the *High-End Trim* and return to the *APM* main menu.

Notes:

- In some applications using LED and CFL bulbs, it may be necessary to lower the *High-End Trim* to achieve an optimum dimming range.
- If there is no button activity for 1 minute, the dimmer will automatically exit *APM* and return to *Normal Operation*.

High-End Trim

IL 7: Brightest High-End (Default)
 IL 6
 IL 5
 IL 4
 IL 3
 IL 2
 IL 1: Dimmest High-End

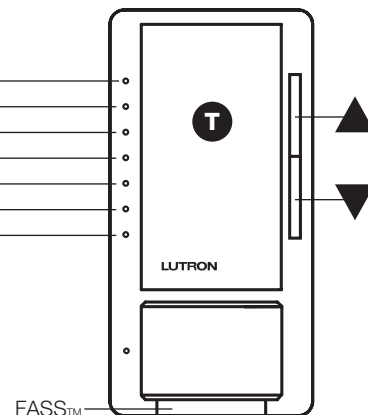

To Exit any mode or programming step:

- Press and hold the T button for 5 seconds
or
- Pull the FASS™ out, then push the FASS™ back in
or
- Wait for 1 minute

Restoring Default Settings

Default settings

Programming Mode

Timeout.	5 minutes
Sensitivity.	High
Auto On	Enabled
Occupied Level.	100%

APM

Preset Light Level.	None selected
Manual Fade to ON time	0.75 seconds
Manual Fade to OFF time.	2.5 seconds
Delayed Fade to OFF time	30 seconds
Nightlight Mode.	Enabled
Low-End Trim.	IL3
High-End Trim	IL7: Brightest High-End

Restoring Default Settings

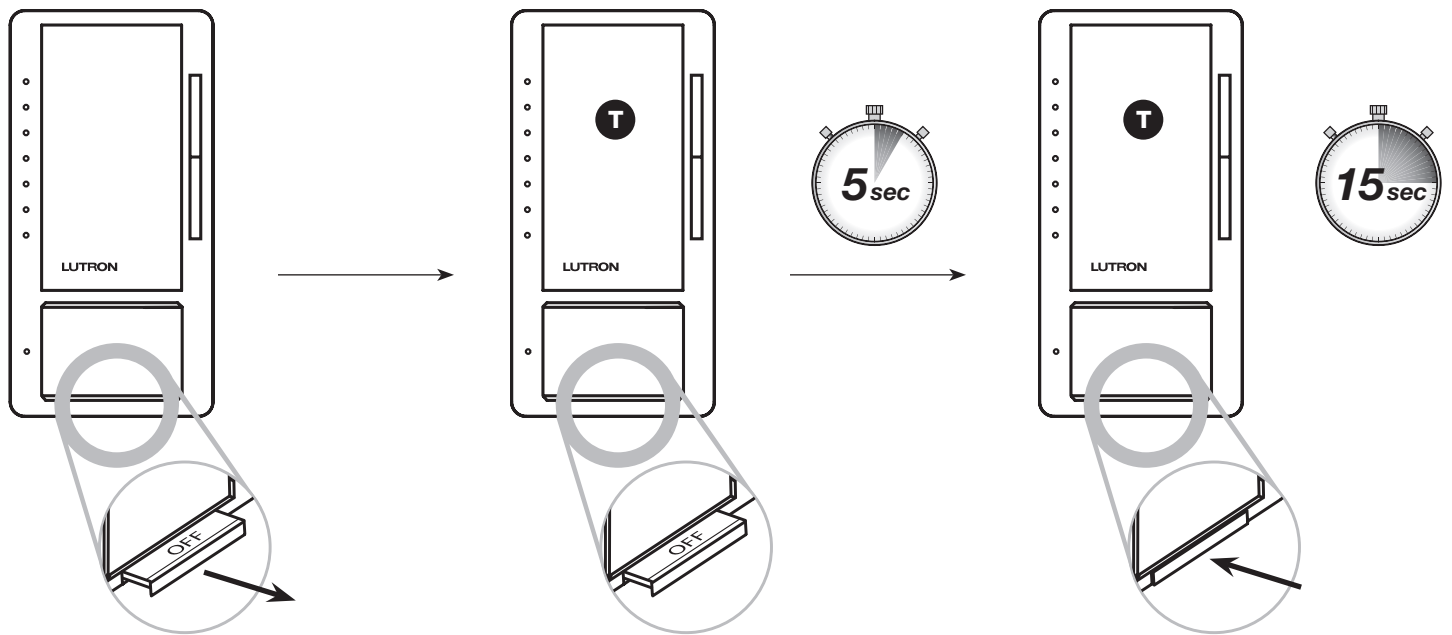

1. Pull the FASS™ into the OFF position (Out); wait 5 seconds.

2. Press and hold the **T** button; continue to hold the **T** button and push the FASS™ back in to the ON Position; continue to hold the **T** button for approximately 15 seconds.

Note: The dimmer will enter APM after the first 5 seconds; continue to hold the **T** button for the remaining 10 seconds until the lights in the room turn OFF and back ON.

3. Load (light) will turn OFF and turn back ON to full intensity. This action represents a successful reset.

Note:

- If you perform the reset sequence, you will return your APM settings to their defaults; you may need to adjust *Low-End Trim* settings to accommodate your particular bulbs.



Two-Location Applications Using an Existing Switch

Settings

An existing 3-way mechanical switch may be used as a second-location control to activate lighting load from either location after a simple rewire. Additional programming is required to work with a mechanical switch and can be found on page 20. If using Companion Dimmer(s) for a 3-way application, additional programming is not required.

Wiring Prerequisites: 3-Way Wiring (Using 3-Way Mechanical Switch)

Note: Diagrams are for reference only. Refer to instruction sheet for proper wiring procedures.

WARNING: Shock Hazard. May result in serious injury or death. Turn OFF power at circuit breaker before installing the unit.

Dimmer Line Side

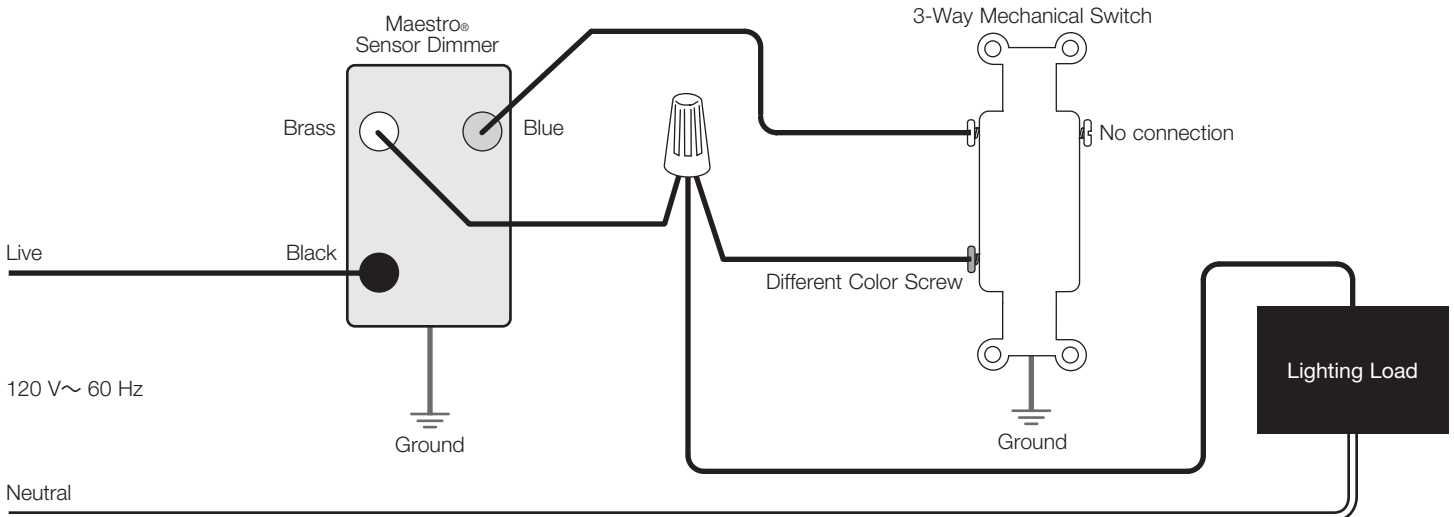

Dimmer Load Side

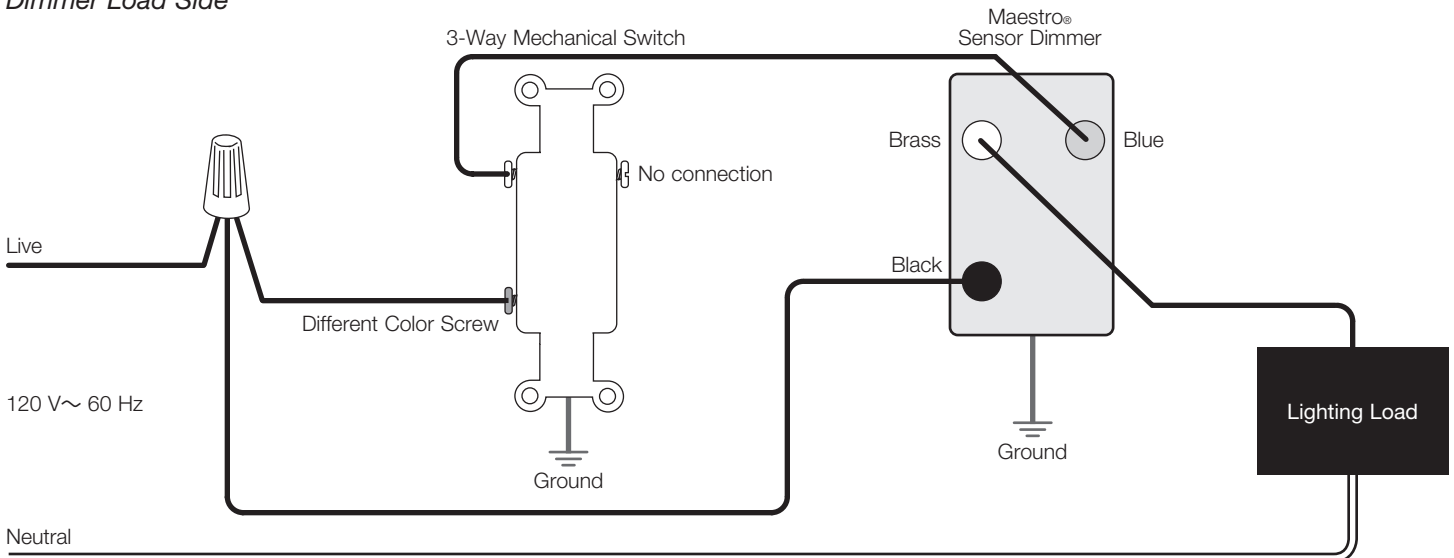

Notes:

- Rewiring of existing switch is required; consult the instruction sheet for installation procedures.
- If switch is not rewired, it may result in abnormal behavior; consult your instruction sheet for wiring procedure.
- If the existing mechanical switch was rewired but the *Two-Location Applications Using an Existing Switch* setting is not changed to select the appropriate second location device, the Maestro® Sensor Dimmer may react abnormally. To resolve, change this setting to the appropriate device.

Continued on next page...

Two-Location Applications Using an Existing Switch (continued)

Selecting Two-Location Application Shortcut

Default Setting

Companion Dimmer (IL 4)

Directions

This feature is accessible *only* through the shortcut and cannot be entered via the *APM* menu.

1. Enter 3-way Programming Menu: **Press and hold** the **T** button **and** the **▲** button until an IL blinks.
2. Select Desired Device: **Press** the **▲** or **▼** button **to select** an option:
 - IL 1: Mechanical Switch
 - IL 4: Companion Dimmer
3. **Press** the **T** button **one time to set** the option and return to the *APM* main menu.

Notes:

- Rewiring of existing switch is required; consult your instruction sheet for installation procedures.
- If switch is not rewired, it may result in abnormal behavior; consult the instruction sheet for wiring procedure.
- If the existing mechanical switch was rewired but the Maestro® Sensor Dimmer was not reprogrammed to accommodate this switch, perform steps 1 and 2 above, and select *Mechanical Switch* (IL 1).

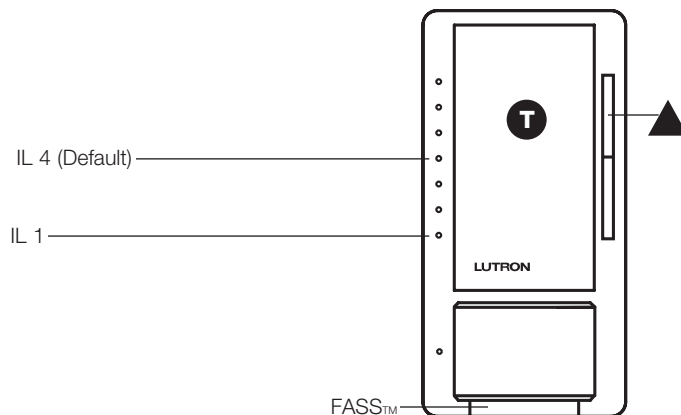

To Exit any mode or programming step:

- **Press and hold** the **T** button for 5 seconds
- or
- **Pull** the *FASS™* out, then **push** the *FASS™* back in
- or
- **Wait** for 1 minute

Ambient Light Detection (ALD)

How it Works

ALD allows you to maximize the cost savings of lighting by keeping lights OFF when the natural light in a space provides adequate lighting.

The Lutron® ALD feature learns your preference as you live with the product in your space. The learning algorithm employs user input to determine when ambient light is not adequate.

Will my Maestro® Sensor Dimmer use ALD?

Your Maestro® Sensor Dimmer will use ALD if you've selected *Ambient Light Detect (ALD)* mode while programming your unit. Some Lutron® in-wall sensor models allow you to change the *Auto-ON* settings independently of ALD. In those models, you must have both ALD and *Auto-ON/Auto-OFF (Occupancy mode)* enabled. Dual Tech sensor models offer two ALD modes: *Learning ALD* and *Fixed ALD*; the *Learning ALD* mode matches the ALD modes used in all other Lutron® in-wall PIR sensors. Refer to the instruction sheet for your product to determine how to activate and use ALD.

How does the Maestro® Sensor Dimmer learn my preference?

Whenever you enter a room with a Lutron® in-wall sensor using the *Learning ALD* feature, the sensor will either turn the lights ON or keep the lights OFF, based on its current light-level threshold set in ALD mode. If you enter the room and the lights do not respond as you'd like, press the **T** button on your Maestro® Sensor Dimmer to turn the lights ON (or OFF, if that was your preference) within 5 seconds of entering the room. The Maestro® Sensor Dimmer has now learned a new light threshold for ALD. The example below illustrates the learning process:

1. You enter the room, the lights stay OFF, and you decide that you want the lights ON because there is not enough ambient light in the space for you.
2. You press the **T** button (within 5 seconds of entering room).
3. The Maestro® Sensor Dimmer has now learned your preference for when lights should turn ON, and adjusted its threshold accordingly.

FAQs

If I press a button AFTER 5 seconds of entering a room, will my Maestro® Sensor Dimmer learn that preference?

No, you must interact within the first 5 seconds of entering the room.

How many times will I have to interact with the Maestro® Sensor Dimmer until it remembers my settings?

Typically, the Maestro® Sensor Dimmer learns the appropriate threshold within 6–10 interactions or less.

Do you offer ALD and Off-While-Occupied (OWO) Enabled together?

When ALD is selected in your Maestro® Sensor Dimmer, OWO is enabled as well. In order for the ALD to respond correctly to the user's preference, it will always maintain the light level in the room for as long as the space is occupied, whether that light level is ON or OFF.

I believe I'm using ALD correctly in my Maestro® Sensor Dimmer, but I'm still not getting the response I expect. What could be happening?

- You may have multiple users with widely different preferences. If multiple users continue to teach the unit separate preferences, it will continue to adjust to meet the threshold, but may be stuck somewhere in between the preferences of the two users.
- You may be trying to apply this feature to an application that is not exposed to daylight. This feature is designed to respond to natural light; it will not necessarily respond with the same sensitivity to synthetic light sources that operate on different wavelengths.
- You may not be able to reach your unit within 5 seconds. If your interactions do not occur within 5 seconds, you may not be teaching the unit a new threshold.

Note: Make sure that you interact with the Maestro® Sensor Dimmer within 5 seconds of entering the room, if you intend to teach it to turn ON. If multiple users interact with the unit on a regular basis, and have different light preferences, the unit may be trying to learn two separate preferences. Ensure that ALL users are educated in how ALD works when ALD is selected.

Will the Maestro® Sensor Dimmer actively adjust the light level to maintain a certain level of brightness in the room?

No, the lights will turn on to whatever level has been set as your *Occupied Level*. ALD allows the unit to determine only *when* light is needed; it does not determine *how much* light you want.

Troubleshooting

Symptom	Possible Cause	Probable Solution
After installation or following a power failure, the lights will turn <i>ON</i> suddenly after the lights have been manually turned <i>OFF</i> .	The sensor takes up to 2 minutes to perform a calibration following a power cycle. If the lights are <i>OFF</i> and the calibration completes while the space is occupied, the lights will turn <i>ON</i> .	Wait at least 2 minutes for calibration to complete. Refer to the instructions. Change <i>Occupied Level</i> to <i>Preset</i> . This will cause occupancy detection to turn your unit <i>ON</i> to the last light level. It is less likely that you will notice this issue if you have selected this setting.
	After installation or after replacing the bulbs, the lights may not turn <i>ON</i> when turning <i>ON</i> the lights manually or when the space is occupied.	The <i>Low-End Trim</i> setting may have to be adjusted. The bulbs may not be on the approved bulb list.
After installation or after replacing the bulbs, the lights may flash when turning <i>ON</i> the lights manually or when the space is occupied.	The <i>Low-End Trim</i> setting may have to be adjusted.	Adjust the low-end trim from either the <i>Shortcut</i> menu or from the <i>APM</i> menu. Refer to instructions to change custom settings.
	The bulbs may not be on the approved bulb list.	Use bulbs that have been approved. Find the approved list for this product at www.lutron.com/dimcflled
After installation or after replacing the bulbs, the ILs may cycle, making the dimmer appear to reset. During this time, the lights may not turn <i>ON</i> or the lights may flash.	The <i>Low-End Trim</i> setting may have to be adjusted.	Adjust the <i>Low-End Trim</i> in the <i>APM</i> menu. Note: In this scenario, the low-end trim cannot be adjusted from the <i>Shortcut</i> menu. Refer to instructions to change custom settings.
	The bulbs may not be on the approved bulb list.	Use bulbs that have been approved. Find the approved list for this product at www.lutron.com/dimcflled
3-way switch does not turn the lights <i>ON</i> .	Multi-location/3-way wiring may be incorrect.	Refer to wiring diagrams in instructions.
	The <i>Multi-Location</i> mode is set for <i>Companion Dimmer</i> .	Change the <i>Two-Location Application</i> mode to <i>Mechanical Switch</i> . Refer to instructions to change custom settings.
	3-way switch may have a locator light.	Replace the 3-way switch with one that doesn't have a locator light.
After installation, IL 3 will start blinking, then IL 2, etc.	A Mechanical switch is wired to the blue wire but the accessory mode is set to <i>Companion Dimmer</i> . This causes the dimmer to think the toggle button is being held and will activate the <i>Delayed Fade To OFF</i> feature.	Change the <i>Two-Location Application</i> mode to <i>Mechanical Switch</i> . Refer to instructions to change custom settings.
Lights do not turn <i>ON</i> when space is occupied.	<i>Sensor</i> mode is set to <i>Manual-ON (Vacancy mode)</i> .	Refer to instructions to change custom settings.
	<i>Sensor</i> mode is set to <i>Auto-ON Daylight Sensing (ALD)</i> and the light level in the room is too bright.	Turn the lights <i>ON</i> within 5 seconds upon entering the room to change the daylight threshold.
	Sensor does not have full view of room.	Move objects blocking the sensor's line-of-sight.
	<i>Sensor</i> mode is set to <i>OFF-While-Occupied (OWO)</i> mode, and the unit was recently manually turned <i>OFF</i> .	Refer to instructions to change custom settings, exit room and wait for sensor to timeout, or manually turn light back <i>ON</i> with T button.
	Multi-location/3-way wiring may be incorrect.	Refer to wiring diagrams in instructions. Wiring of a 3-way mechanical switch with this product is different from traditional 3-way wiring.

Continued on next page...

Troubleshooting (continued)

Symptom	Possible Cause	Probable Solution
Lights turn back <i>ON</i> after they are manually turned <i>OFF</i> .	<i>Sensor mode</i> is set to <i>Auto ON: Enabled (Occupancy mode)</i> . The lights will continue to turn back on 25 seconds after the lights are manually turned <i>OFF</i> if the space is still occupied.	Change the <i>Sensor mode</i> to <i>Auto ON: Disabled (Vacancy mode)</i> or <i>OFF-While-Occupied (OWO)</i> mode. Refer to instructions to change custom settings.
Lights turn <i>OFF</i> while the space is still occupied.	Sensor's timeout is too short for this application.	Increase timeout (e.g., 5 minutes to 30 minutes).
	Sensor does not have full view of room.	Move objects blocking the sensor's line-of-sight.
	Sensor's sensitivity is set too low.	Change sensitivity to <i>High</i> .
Lights stay <i>ON</i> after space is vacated.	Sensor's timeout has not yet expired.	Wait for the timeout to expire.
	Motion is being detected from an external noise source such as an HVAC vent.	Change the sensitivity to <i>Low</i> . Try to eliminate the external noise source.
Lights turn <i>ON</i> when walking past room.	Sensor coverage extends beyond room perimeter.	Change sensitivity to <i>Low</i> . Block part of the lens.
	Reflections off shiny objects can allow the sensor to see outside the typical coverage.	Change sensitivity to <i>Low</i> . Block part of the lens.
Lights turn <i>ON</i> in <i>Vacancy mode</i> .	Lights can turn <i>ON</i> in the 15 second "grace period" following timeout.	If <i>Timeout</i> is set to 1 minute, wait for 1 minute 30 seconds before entering room again to verify that lights don't turn back <i>ON</i> .
	<i>Sensor mode</i> may be set to something other than <i>Manual-ON (Vacancy mode)</i> .	Refer to instructions to change custom settings.
Turning the lights <i>ON</i> with a 3-way switch caused the lights to flash.	If the sensor detects occupancy just prior to turning the lights <i>ON</i> from the 3-way switch, the lights will turn <i>ON</i> and the 3-way switch will turn the lights <i>OFF</i> .	Set the <i>Sensor mode</i> to <i>Auto ON: Disabled (Vacancy mode)</i> . Refer to instructions to change custom settings.
Following a power cycle, the lights turn <i>ON</i> to the full dim level, but the ILs are <i>OFF</i> .	If the Maestro® Sensor Dimmer is connected to a generator, the dimmer may go into a different operating mode.	Press the Toggle button to resume <i>Normal Operation</i> .
When turning the lights <i>ON</i> to the maximum dim level, the light dim level may go to high-end and then drop to a lower dim level.	The dimmer has an internal protection mechanism that will reduce the dim level if the maximum level causes the dimmer to function incorrectly.	Adjust the <i>High-End Trim</i> from the <i>APM</i> menu. Refer to instructions to change custom settings.
	The bulbs may not be on the approved bulb list.	Use bulbs that are on the approved list. Find the approved list for this product at www.lutron.com/dimcflled
The sensor IL does not work.	The sensor IL will not glow to acknowledge motion if the lights are <i>OFF</i> .	Make sure the load is <i>ON</i> , and wave to confirm that the sensor IL is operational.

Maestro® Sensor Dimmer Bulb Compatibility

Note: For the most up-to-date bulb compatibility list, please visit www.lutron.com/dimcflled

Lutron, Maestro, and C•L are registered trademarks and FASS is a trademark of Lutron Electronics Co., Inc.

Lutron Contact Numbers

WORLD HEADQUARTERS

USA

Lutron Electronics Co., Inc.
7200 Suter Road
Coopersburg, PA 18036-1299

TEL: +1.610.282.3800
FAX: +1.610.282.1243
Toll-Free: 1.888.LUTRON1
Technical Support: 1.800.523.9466
intsales@lutron.com

North & South America Technical Hotlines

USA, Canada, Caribbean:

1.800.523.9466

Mexico:

+1.888.235.2910

Central/South America:

+1.610.282.6701

EUROPEAN HEADQUARTERS

United Kingdom

Lutron EA Ltd.
6 Sovereign Close
London, E1W 3JF
United Kingdom

TEL: +44.(0)20.7702.0657
FAX: +44.(0)20.7480.6899
FREEPHONE (UK): 0800.282.107
Technical Support: +44.(0)20.7680.4481
lutronlondon@lutron.com

ASIAN HEADQUARTERS

Singapore

Lutron GL Ltd.
15 Hoe Chiang Road
#07-03, Tower 15
Singapore 089316

TEL: +65.6220.4666
FAX: +65.6220.4333
Technical Support: 800.120.4491
lutronsea@lutron.com

Asia Technical Hotlines

Northern China: 10.800.712.1536

Southern China: 10.800.120.1536

Hong Kong: 800.901.849

Indonesia: 001.803.011.3994

Japan: +81.3.5575.8411

Macau: 0800.401

Taiwan: 00.801.137.737

Thailand: 001.800.120.665853

Other Countries: +65.6220.4666