

Portable Air Conditioner CF14T

Product ID: M46MK
QCFDI

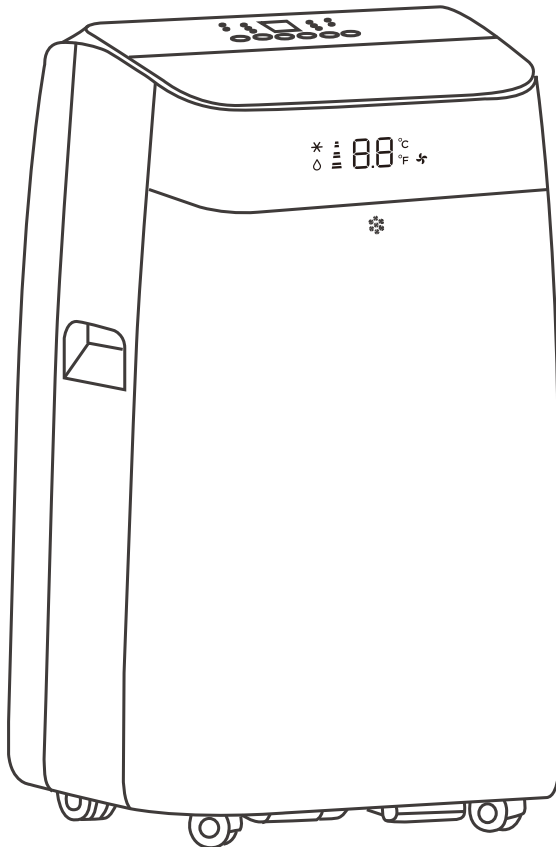

Scan for Support



Distributed by
GARVEE.com

support@garvee.com

CONTENTS

■ Important Safeguards	01
■ Description	06
■ Accessories	07
■ Installation	08
■ Control Panel	10
■ Remote Control	13
■ Tips for Correct Use	18
■ Water Drainage Method	19
■ Cleaning	21
■ Start-end of Season Operations	22
■ Troubleshooting	23

Important Safeguards

- This appliance is for household use only.
- Disconnect the appliance from its power source during service and when replacing parts and cleaning.
- Please note: Check the nameplate for the type of refrigerant gas used in your appliance.
- Specific information regarding appliances with refrigerant gas.
The appliance is recommended not to pierce the cooling circuit of the machine. At the end of its useful life, deliver the appliance to a special waste collection centre for disposal.
GWP (Global Warming Potential): R410A: 2088, R134a: 1430, R290: 3, R32: 675.
- This hermetically sealed system contains fluoridated greenhouse gases.
- **Environmental Information:** This unit contains fluoridated greenhouse gases covered by the Kyoto Protocol.
- Do not use this unit for functions other than those described in this instruction manual.
- Make sure the plug is plugged firmly and completely into the outlet. It can result in the risk of electric shock or fire.
- Do not plug other appliances into the same outlet, it can result in the risk of electric shock.
- Do not disassemble or modify the appliance or the power cord, it can result in the risk of electric shock or fire. All other services should be referred to a qualified technician.
- Do not place the power cord or appliance near a heater, radiator, or other heat source. It can result in the risk of electric shock or fire.
- This unit is equipped with a cord that has a earthed wire connected to an earthed pin or grounding tab. The plug must be plugged into a socket that is properly installed and earthed. Do not under any circumstances cut or remove the earthed pin or grounding tab from this plug.
- The unit should be used or store in such a way that it is protected from moisture e.g. condensation, splashed water, etc. Unplug unit immediately if this occurs.
- Always transport your appliance in a vertical position and place on a stable, level surface during use. If the unit is transported laying on its side it should be stood up and left unplugged for 6 hours.
- Always use the switch on the control panel or remote controller to turn the unit off, and do not start or stop operation by plugging in or unplugging the power cord. It can result in the risk of electric shock.
- Do not touch the buttons on the control panel with your wet and damp fingers.
- Do not use hazardous chemicals to clean or come into contact with the unit. To prevent damage to the surface finish, use only a soft cloth to clean the appliance. Do not use wax, thinner, or a strong detergent. Do not use the unit in the presence of inflammable substance or vapour such as alcohol, insecticides, gasoline, etc.
- If the appliance is making unusual sounds or is emitting smoke or an unusual odor, unplug it immediately.
- Do not clean the unit with water. Water can enter the unit and damage the insulation, creating a shock hazard. If water enters the unit, unplug it immediately and contact Customer Service.
- Utilize two or more people to lift and install the unit.
Always grasp the plug when plugging in or unplugging the appliance. Never unplug by pulling on the cord. It can result in the risk of electrical shock and damage.

- Install the appliance on a sturdy, level floor capable of supporting up to 110lbs (50kg). Installation on a weak or unlevel floor can result in the risk of property damage and personal injury.
- This appliance is not intended for use by persons (including children) with reduced physical, sensory or mental capabilities, or lack of experience and knowledge, unless they have been given supervision or instruction concerning use of the appliance by a person responsible for their safety.
- Children should be supervised to ensure that they do not play with the appliance.
- If the SUPPLY CORD is damaged, it must be replaced by the manufacturer, its service agent or similarly qualified persons in order to avoid a hazard.
- The appliance shall be installed in accordance with national wiring regulations.

Important - Grounding Method

This product is factory equipped with a power supply cord that has a three-pronged grounded plug. It must be plugged into a mating grounding type receptacle in accordance with the National Electrical Code and applicable local codes and ordinances. If the circuit does not have a grounding type receptacle, it is the responsibility and obligation of the customer to exchange the existing receptacle in accordance with the National Electrical Code and applicable local codes and ordinances. The third ground prong should not, under any circumstances, be cut or removed. Never use the cord, the plug or the appliance when they show any sign of damage. Do not use your appliance with an extension cord unless it has been checked and tested by a qualified electrical supplier. Improper connection of the grounding plug can result in risk of fire, electric shock and/or injury to persons associated with the appliance. Check with a qualified service representative if in doubt that the appliance is properly grounded.



WARNING

Electrical Shock Hazard

- Plug into a grounded 3 prong outlet.
- Do not remove the ground prong.
- Do not use an adapter.
- Do not use an extension cord.
- Failure to follow these instructions can result in death, fire, or electrical shock.

Preferred Grounding Method

60Hz, 115V AC outlet protected by a 15 amp time delay fuse or circuit breaker.

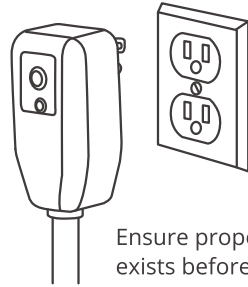

Ensure proper ground exists before use.

Temporary Grounding Method

Use of adapter plugs is not permitted in Canada.

Ensure proper ground exists before use.

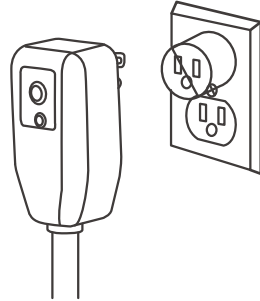

Integrated Circuit Breaker

For additional safety, the power cord features an integrated circuit breaker. Test and reset buttons are provided on the plug case.

The circuit breaker should be tested periodically by pressing the TEST button. If it does not cause the circuit breaker to trip, or if the RESET button will not stay engaged, unplug the appliance immediately and contact your service technician.

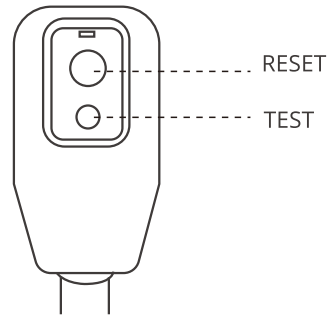

Note: Your appliance's power cord and plug may differ from above the picture shows.

Recommended Ground Method

For your personal safety, this appliance must be grounded. This appliance is equipped with a 3 prong power supply cord with a grounded plug. To minimize the possibility of electrical shock, the cord must be plugged into a 3 prong outlet and grounded in accordance with all local codes and ordinances. If a 3 prong outlet is not available, it is the customer's responsibility to have a properly grounded 3 prong outlet installed by a qualified electrician. Never use a broken or damaged adapter.

Electrical Connections

Before plugging the appliance into the mains socket, check that:

- The mains power supply corresponds to the value indicated on the rating plate on the back of the appliance.
- The power socket and electrical circuit are adequate for the appliance.
- The mains socket matches the plug. If this is not the case, have the plug replaced.
- The mains socket is adequately earthed. Failure to follow these important safety instructions absolves the manufacturer of all liability.



WARNING

- Do not use means to accelerate the defrosting process or to clean, other than those recommended by the manufacturer.
- The appliance shall be stored in a room without continuously operating ignition sources (**for example:** open flames, an operating gas appliance or an operating electric heater).
- Do not pierce or burn.
- Be aware that refrigerants may not contain an odour.
- The above 4 statements shall also be accompanied by the risk of fire symbol. This symbol shows a flame in a triangle (warning symbol W021 of ISO 7010).

The handling, installation, storage, servicing and disposal must comply with the provisions of gas-related national laws and regulations, and also national wiring regulation.

It is necessary to clear away the refrigerant in the system when maintaining or scrapping an appliance.

Ventilated area (open doors and Windows)

Ensure that the working area is open or well ventilated before turning on the system or performing hot work. Ventilation should be maintained during operation. Ventilation quickly displaces safely diluted leaked refrigerant into the atmosphere.

Flammable refrigerant R32/R290 is used within appliance. Please follow the instructions carefully to handle, install, clean, and service the appliance to avoid damage or hazard. Do not dispose of appliance in regular trash. Contact qualified agency for proper disposal.

Servicing shall be performed only as recommended by the manufacturer.



A2L



Description

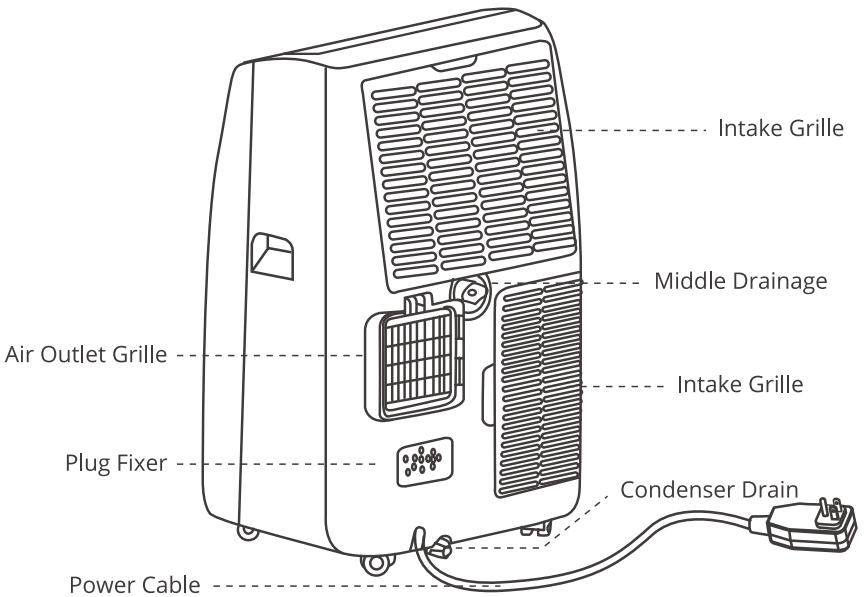
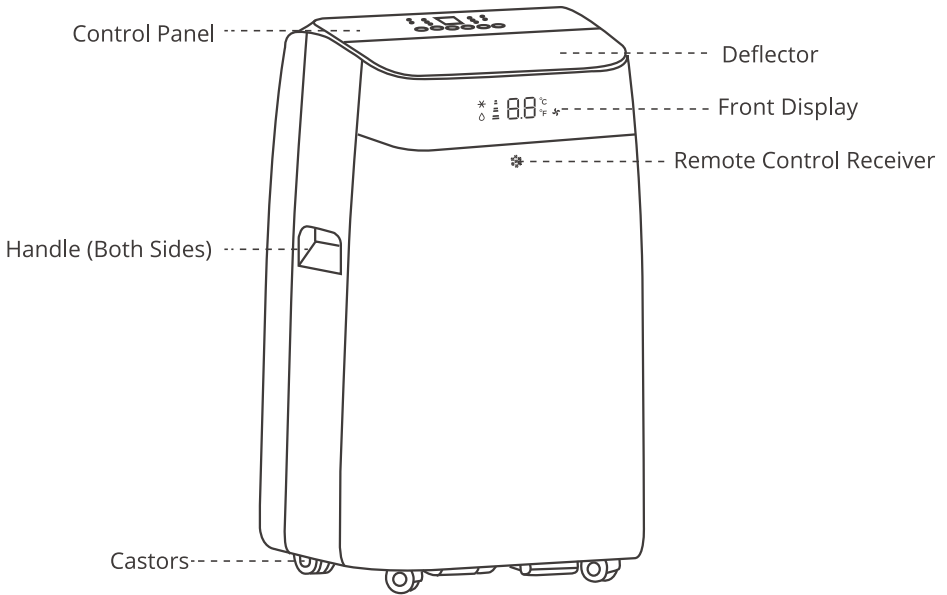

Accessories



Hose Inlet

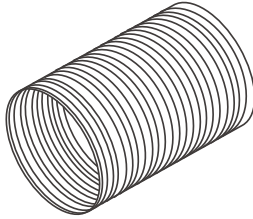

Exhaust Hose

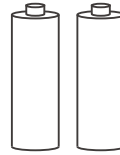

Battery

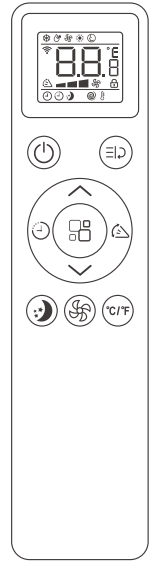

Remote Control

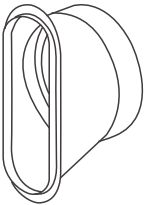

Hose Outlet

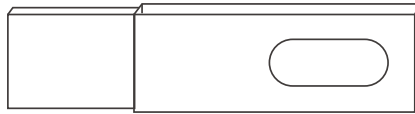

Window Slider Kit

Note: All the illustrations in this manual are for explanatory purposes only. Your appliance may be slightly different.

Be sure all accessories are removed from the packing before use.

Installation

Exhausting Hot Air

When use the appliance in cool mode, the hot air exchange of the condenser must be exhausted out of the room completely.

First position unit on a flat floor and make sure there's a minimum of 18" (45cm) clearance around the unit, and is within the vicinity of a single circuit outlet power source.

- Extend either side of the hose (Fig.1), and screw the hose inlet (Fig.2).
- Extend the other side of the hose and screw it to the hose outlet (Fig.3).
- Install the hose inlet into the unit (Fig.4).
- Affix the hose outlet into the window slider kit and seal.

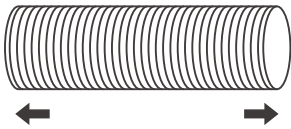

Extend the side of hose

Fig.1

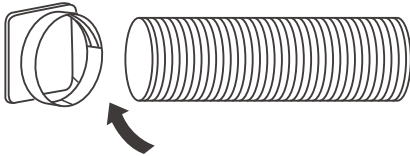

Fig.2

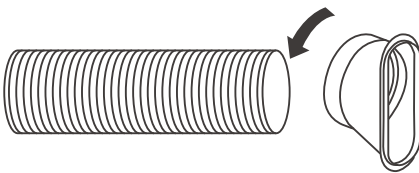

Fig.3

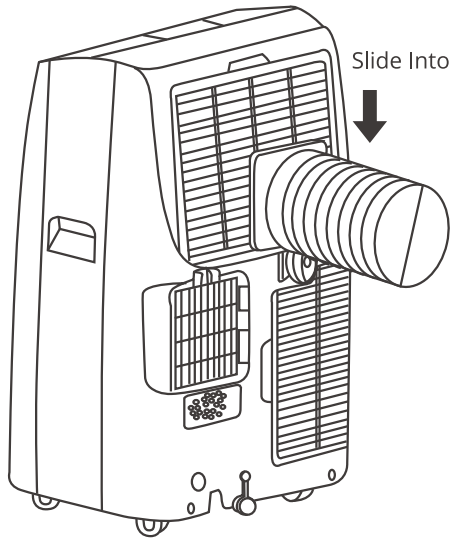

Fig.4

The window slider kit has been designed to fit most standard vertical and horizontal window applications, however, it may be necessary for you to modify some aspects of the installation procedures for certain types of windows. The window slider kit can be fastened with screws.

NOTE:

If the window opening is less than the minimum length of the window slider kit, cut the end without the hold in it short enough to fit in the window opening. Never cut out the hole in window slider kit.



Cut on opposite side of hole.

Window Slider Kit Installation

● Parts

- A) Panel
- B) Panel with one hole
- C) Screw to lock window kit in place

● Assembly

Slide Panel B into Panel A and size to window width. Windows sizes vary. With the width that your window requires to ensure that there are no gaps or air pockets in the window kit assembly after installation.

Lock the screw into the holes that correspond.

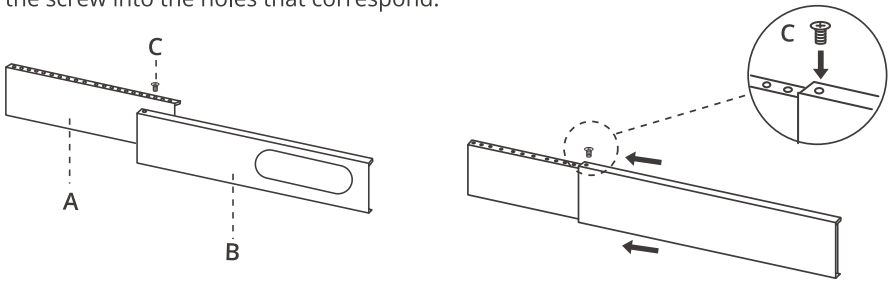

● Location

- 1) The unit should be placed on a firm foundation to minimize noise and vibration. For safe and secure positioning place the unit on a smooth, level floor strong enough to support the unit.
- 2) The unit has casters to aid placement, but it should only be rolled on smooth, flat surfaces. Use caution when rolling on carpeted surfaces. Use caution and protect floors when rolling over wood floors. Do not attempt to roll the unit over objects.
- 3) The unit must be placed within reach of a properly rated grounded socket.
- 4) Never place any obstacles around the air inlet or outlet of the unit.
- 5) Allow at least 18" (45cm) of around and above space away from the wall for efficient working.
- 6) The hose can be extended, but it is the best to keep the length to minimum required. Also make sure that the hose does not have any sharp bends or sags.

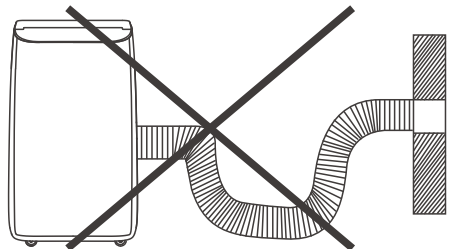
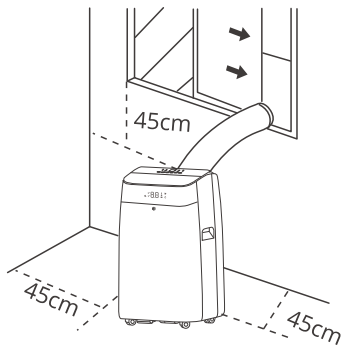

Control Panel

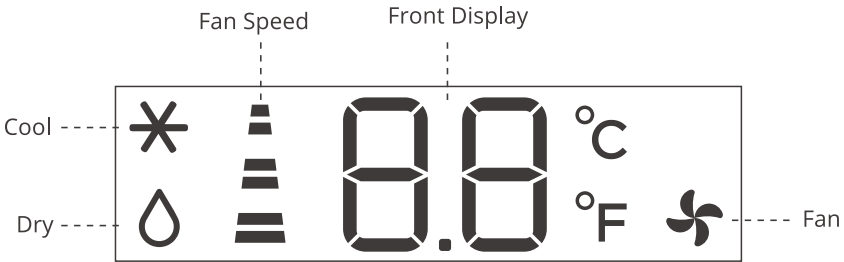
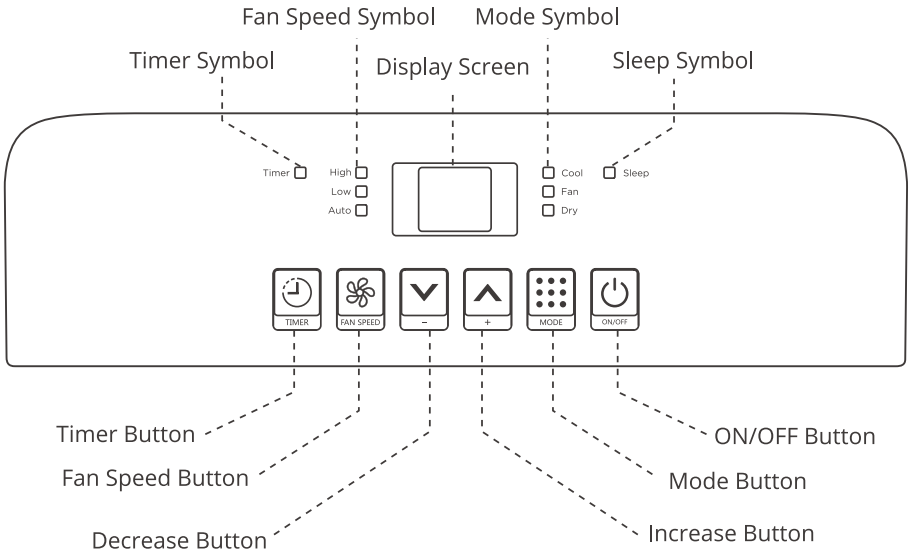

Turning the Appliance On





Plug into the mains socket, then the appliance is standby.

Press the  button to make the appliance turn on. The last function active when it was turned off will appear.



COOL Mode

Ideal for hot muggy weather when you need to cooling and dehumidify the room. To set this mode correctly:



- Press the  button a number of times until the "Cool" symbol appears.
- Select the target temperature 18°C-32°C (64°F-90°F) by pressing the  or  button until the corresponding value is displayed.
- Select the required fan speed by pressing the  button. Three speeds are available: High / Low / Auto.













The most suitable temperature for the room during the summer varies from 24°C to 27°C (75°F to 81°F). You are recommended, however, not to set a temperature much below the outdoor temperature. The fan speed difference is more noticeable when the appliance is under Fan mode but may not be noticeable under Cool mode.

FAN Mode

When using the appliance in this mode, the air hose does not need to be attached.

- Press the  button a number of times until the "Fan" symbol appears.
- Select the required fan speed by pressing the  button.
Two speeds are available: High / Low.



- The screen display " 
 " as high speed, "  " as low speed.
- The front display "   
 " as high speed, "   " as low speed.

DRY Mode

Ideal to reduce room humidity (spring and autumn, damp rooms rainy periods, etc). In dry mode, the appliance should be prepared in the same way as for cool mode, with the air exhaust hose attached to enable the moisture to be discharged outside.

To set this mode correctly:

- Press the  button a number of times until the Dry symbol appears. The screen display "dh".
- In this mode, fan speed is selected automatically by the appliance and can not be set manually.

SMART Mode

The appliance chooses automatically whether to operate in cool, fan or heat (certain models only) mode.

To set this mode correctly:

- Press the  button a number of times until the screen show like below:

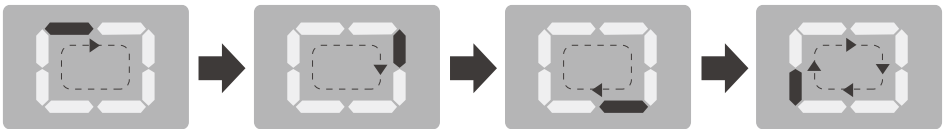

- Select the required fan speed by pressing the  button.
Three speeds are available: High / Low / Auto.

If the appliance is cooling only model, the unit operates in Fan mode when the room temperature is below 23°C (73°F), and Cool mode when the room temperature is above 23°C (73°F).

Setting the Timer

This timer can be used to delay the appliance start-up or shutdown, this avoids wasting electricity by optimizing operating periods.

Programming start-up

- Turn on the appliance, choose the mode you want, for example Dehumidify mode, high fan speed. Turn off the appliance.
- Press the "⌚" button, the screen starts to flash, press the "▲" and "▼" to adjust the set time from 0.5-24 hours.
- In 5 seconds without the operation, the timer start function, then the "Timer" symbol lights.
- Press the "⌚" button again to cancel the Timer, and the "Timer" symbol disappear.

Programming shut down

- When the appliance is running, press the "⌚" button, the screen starts to flash.
- Press the "▲" and "▼" to adjust the set time from 0.5-24 hours.
- In 5 seconds without the operation, the timer start function, then the "Timer" symbol lights.
- Press the "⌚" button again to cancel the Timer, and the "Timer" symbol disappear.

Switch the unit of temperature

When the appliance is running, hold on "▲" and "▼" button together 3 seconds by the same time, then you can change the unit of temperature.

For example:

Before change, in cool mode, the screen display like fig5.

After change, in cool mode, the screen display like fig6.



Fig.5





Fig.6

The following functions below are optional. Please refer to the real object, just because these functions only belong to some model.

Self-diagnosis

The appliance has a self diagnosis system to identify a number of malfunctions. Error messages are displayed on the appliance display.

If is displayed	What should i do?
 Probe Failure (sensor damaged)	If this is displayed, contact your local authorize service centre.
 Full Tank (safety tank full)	Empty the internal safety tank, following the instructions in the "End of season operations" paragraph.

Remote Control

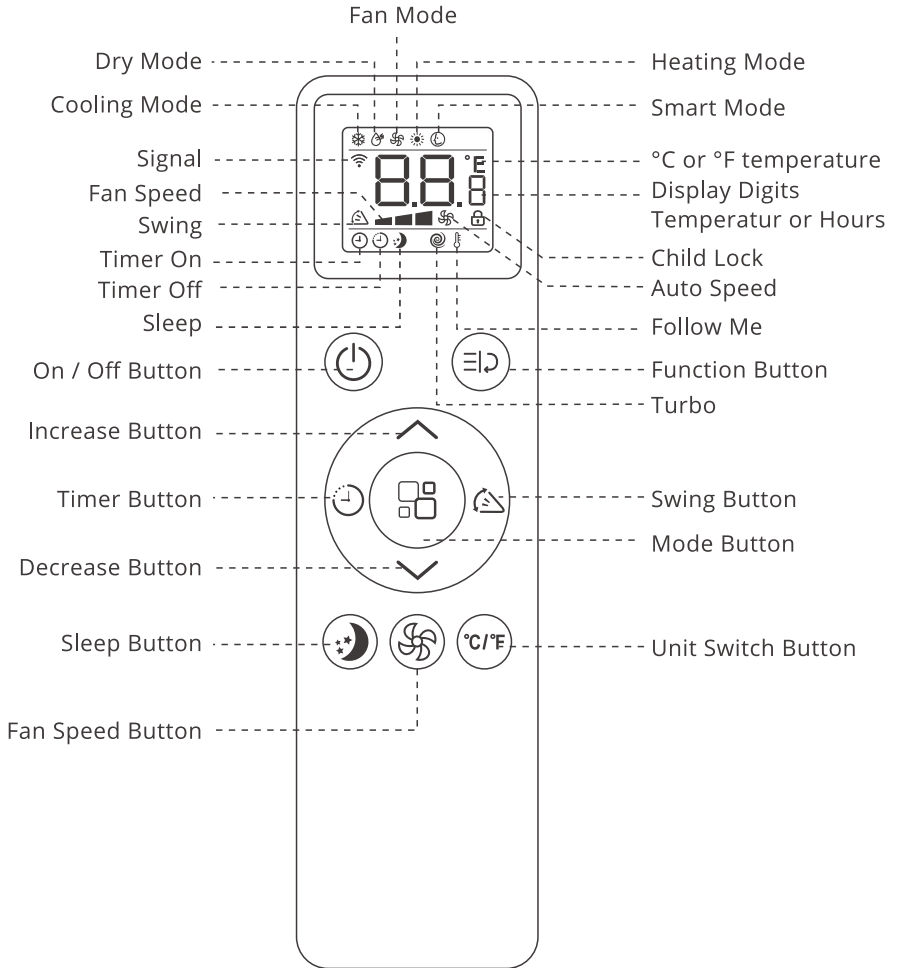

- Point the remote control at the receiver on the appliance.
- The remote control must be no more than 7 meters away from the appliance (without obstacles between the remote control and the receiver).
- The remote control must be handled with extreme care. Do not drop it or expose it to direct sunlight or sources of heat.
- If the remote control do not work, please try to take out the battery, and put it back again.

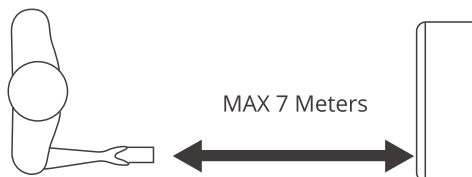

Inserting or Replacing the Batteries

- Remove the cover on the rear of the remote control.
- Insert two "AAA" 1.5V batteries in the correct position (see instructions inside the battery compartment).
- Put the cover back to the remote control.

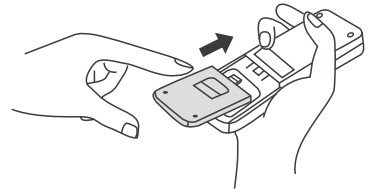





NOTE:

- If the remote control unit is replaced or disposed of, the batteries must be removed and discarded in accordance with current legislation as they are harmful to the environment.
- Do not mix old and new batteries. Do not mix alkaline, standard (carbon-zinc) or rechargeable (nickel-cadmium) batteries.
- Do not dispose of batteries in fire. Batteries may explode or leak.
- If the remote control is not be used for a certain length of time, remove the batteries.





COOL mode

Ideal for hot muggy weather when you need to cooling and dehumidify the room.

To set this mode correctly:

- Press the  button a number of times until the  symbol appears.
- Select the target temperature 18°C -32°C (64°F-90°F) by pressing. The  or  button until the corresponding value is displayed.
- Select the required fan speed by pressing the  button. Three speeds are available: High / Low / Auto.



Low		High	Auto
			

The most suitable temperature for the room during the summer varies from 24°C to 27°C (75°F to 81°F). You are recommended, however, not to set a temperature much below the outdoor temperature. The fan speed difference is more noticeable when the appliance is under FAN mode but may not be noticeable under COOL mode.

HEAT Mode

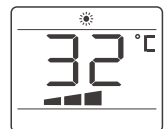

(This model do not have this function)

When choose the heat mode, appliance will turn to FAN mode.



FAN Mode

When using the appliance in this mode, the air hose does not need to be attached.

- Press the  button a number of times until the  symbol appears.
- Select the required fan speed by pressing the  button. Two speeds are available: High / Low.

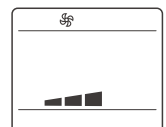



DRY Mode

Ideal to reduce room humidity (spring and autumn, damp rooms rainy periods, etc).



In dry mode, the appliance should be prepared in the same way as for cool mode, with the air exhaust hose attached to enable the moisture to be discharged outside.

To set this mode correctly:

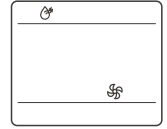
- Press the  button a number of times until the  symbol appears.
- In this mode, fan speed is selected automatically by the appliance and can not be set manually.



SMART Mode

- Press the  button, a number of times until the  symbol appears.
- Select the required fan speed by pressing the  button.
Three speeds are available: High / Low / Auto.

If the appliance is cooling only model, the unit operates in Fan mode when the room temperature is below 23°C (73°F), and Cool mode when the room temperature is above 23°C (73°F).

Display on the control panel:

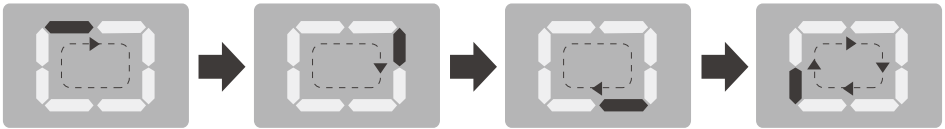



The display will be running circulating.

SLEEP Function

This function is useful for the night as it gradually reduces operation of the appliance.

To set this function correctly:

- Select the cool or heat mode as described above.
- Press the  button, and the  symbol appears.
- When you choose the sleep function, the screen will reduce the brightness, and the fan speed is low.



The SLEEP function maintains the room at optimum temperature without excessive fluctuations in either temperature or humidity with silent operation. Fan speed is always at Low, while room temperature and humidity vary gradually to ensure the most comfortable.

When in COOL mode, the selected temperature will increase by 1°C (1°F) per hour in a 2 hour period. This new temperature will be maintained for the next 6 hours. Then the appliance turn it off.



The SLEEP function can be canceled at any time during operation by pressing the "Sleep", "Mode" or "fan speed" button.

In DRY mode, SLEEP function is still available.

SWING Function

This function moves the deflectors to adjust the direction of the air flow.

To set this function correctly:

- Select the operating mode (cool, dry, fan) as described above.
- Press the  button to select the horizontal deflector to automatically move up and down.
- Press the  button again to switch off this function.

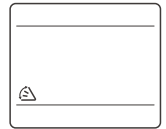

Switch the Unit of Temperature

When the appliance is running, press the °C/°F button, then you can change the unit of temperature.

For example:

- Before change, in cool mode, the screen display like fig7.
- After change, in cool mode, the screen display like fig8.



Fig.7



Fig.8

Setting the Timer

This timer can be used to delay the appliance start-up or shutdown, this avoids wasting electricity by optimizing operating periods.

Programming start up



- Turn on the appliance, choose the mode you want, for example cool, 24°C, high fan speed. Turn off the appliance.
- Press the  button twice, the screen will display hours, the  symbol and  symbol are flashing. (fig.9)



Fig.9







- Press the  or  button until the corresponding time is displayed.
- Press the  button again, the timer will be active, the  symbol and are displayed on screen. (fig.10)
- Press the  button again or the  button, the timer will be canceled, and the  symbol will disappear from screen.



Fig.10

Programming shut down











- When the appliance is running, press the  button, the screen will display hours, and the  symbol and  symbol are flashing. (fig.11)
- Press the  or  button until the corresponding time is displayed.
- Press the  button again, the timer will be active, the  symbol and are displayed on screen. (fig.12)
- Press the  button again or the  button, the timer will be canceled, and the  symbol will disappear from screen.





Fig.11

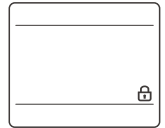

Fig.12











CHILD LOCK Function

This function is used to prevent children from pressing remote controller carelessly or accidentally.

- Hold down the  and  and press for more than 3 seconds
 - to open or cancel the child lock function.
- When the child lock icon is on, pressing any button on the remote control will be invalid.







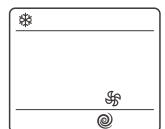





Turbo Function

- Press the  button, the  symbol flash on screen,
- Press the  button again to confirm, the  will stop flash and show on screen, that the function is working.
- This function set the appliance directly to COOL mode with setting temperature 18°C (64°F) and High fan speed in order to reach low temperature in the shortest time.
- To cancel this function, press the , the  flash on screen,
- and then press the  button again to confirm, the  will stop flash and disappear from screen.
- Press other button like " " or " " or " " also can cancel this function.



Follow Me Function

- This function can be activated from the remote control ONLY.
- The remote control serves as a remote thermostat allowing for the precise temperature control at its location.
- To activate the Follow Me function, point the remote control towards the appliance and press the  button, and then press  or  button to until the  flash on screen, and then press the  button again to confirm, the will stop flash and show on screen.
- The remote display is actual temperature at its location. The remote control will send this signal to the air conditioner every 20 minutes interval until press the Follow Me / Temp Sensing button again.
- If the unit does not receive the Follow Me / Temp Sensing signal during any 25 minutes interval, the unit will exit the Follow Me / Temp Sensing mode.
To cancel this function, press the , and then press  or  button to until the  flash on screen, and then press the  button again to confirm, the will  stop flash and disappear from screen.



■ Tips for Correct Use

To get the best from your appliance, follow these recommendations:

- Close the windows and doors in the room to be air conditioned (fig.13). When installing the appliance semi-permanently, you should leave a door slightly open (as little as 1 cm) to guarantee correct ventilation.
- Protect the room from direct exposure to the sun by partially closing curtains and / or blinds to make the appliance much more economical to run (fig.14).

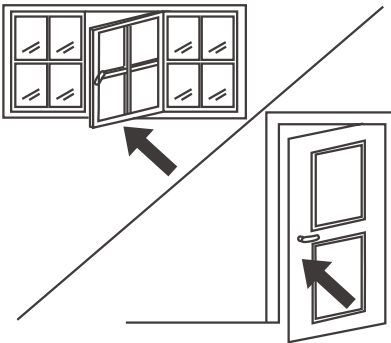

Close door and windows

Fig.13

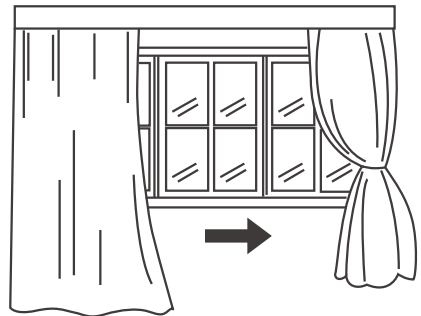

Close curtains

Fig.14

- Never rest objects of any kind on the appliance.
- Do not block the air inlet or outlet of the appliance. Reduced air flow will result in poor performance and could damage the unit (fig.15).
- Make sure there are no heat sources in the room.
- Never use the appliance in very damp rooms (laundries for example).
- Never use the appliance outdoors.
- Make sure the appliance is standing on a level surface. If necessary, place the castor locks under the front wheels.

Do not cover the appliance

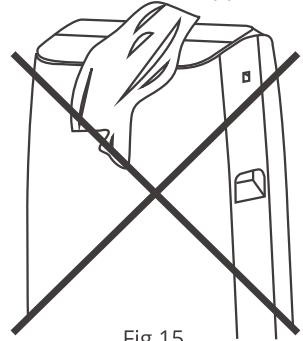

Fig.15

Water Drainage Method

When there is excess water condensation inside the unit, the appliance stops running and shows "FE" (FULL TANK as mentioned in SELF-DIAGNOSIE). This indicates that the water condensation needs to be drained using the following procedures:

Manual Draining

Water may need to be drained in high humidity areas.

- Unplug the unit from power source.
- Place a drain pan under the lower drain plug. See diagram.
- Remove the lower drain plug.
- Water will drain out and collect in the drain pan (not supplied).
- After the water is drained, replace the lower drain plug firmly.
- Turn on the unit.

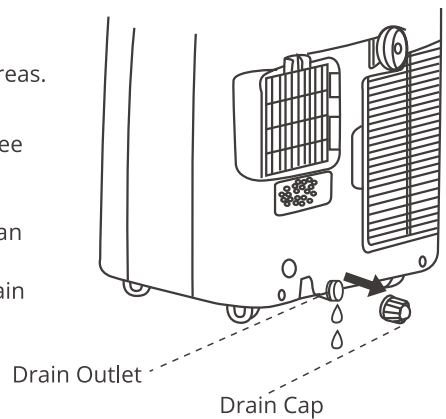

Middle Drainage

When unit running in Dry mode, you can choose the way below to drainage.

- Unplug the unit from the power source.
- Remove the drain plug(fig.18). While doing this operation some residual water may spill so please have a pan to collect the water.
- Connect the drain hose (1/2" or 12.7mm, maybe not supplied). (fig.19)
- The water can be continuously drained through the hose into a floor drain or bucket.
- Turn on the unit.

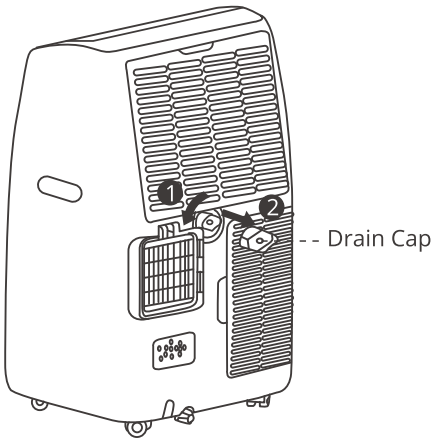

Fig.18

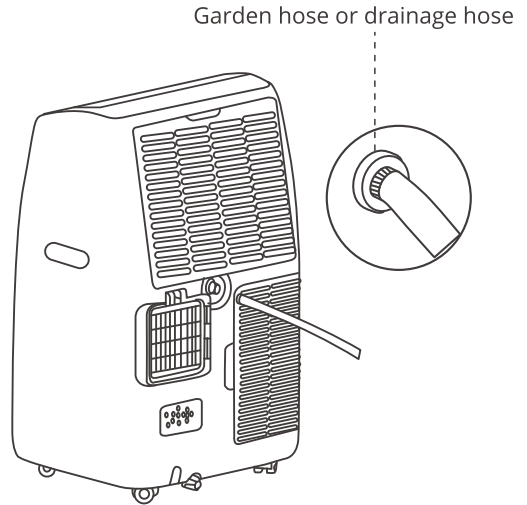

Fig.19

NOTE:

Please be sure that the height of and section of the drain hose should not be higher than that of the drain outlet, or the water tank may not be drained. (fig.20 and fig.21)

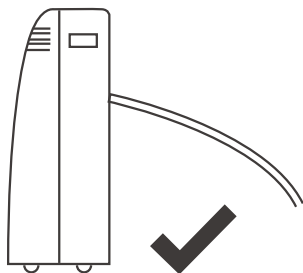

Fig.20

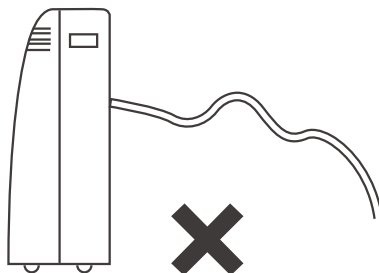



Fig.21

■ ■ Cleaning

Before cleaning or maintenance, turn the appliance off by pressing the  button on the control panel or remote control, wait for a few minutes then unplug from the mains socket.

Cleaning the Cabinet

You should clean the appliance with a slightly damp cloth then dry with a dry cloth.

- Never wash the appliance with water. It could be dangerous.
- Never use petrol, alcohol or solvents to clean the appliance.
- Never spray insecticide liquids or similar.

Cleaning the Air Filters

To keep your appliance working efficiently, you should clean the filter every month of operation. The filter can take out like fig below.

To avoid possible cuts, avoid contacting the metal parts of the appliance when removing or reinstalling the filter. It can result in the risk of personal injury.

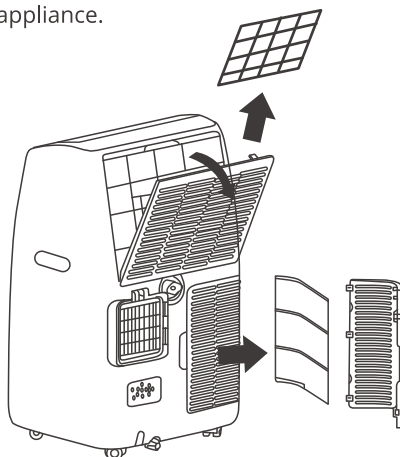

Use a vacuum cleaner to remove dust accumulations from the filter. If it is very dirty, immerse in warm water and rinse a number of times. The water should never be hotter than 40°C (104°F). After washing, leave the filter to dry then attach the intake grille to the appliance.

■ ■ Start-end of Season Operations

Start of Season Checks

Make sure the power cable and plug are undamaged and the earth system is efficient. Follow the installation instructions precisely.

End of Season Operations

To empty the internal circuit completely of water, remove the cap.

Run off all water left into a basin. When all the water has been drained, put the cap back in place.

Clean the filter and dry thoroughly before putting back.

Strictest operation environment:

Cooling mode: 18°C-35°C (64°F-95°F)

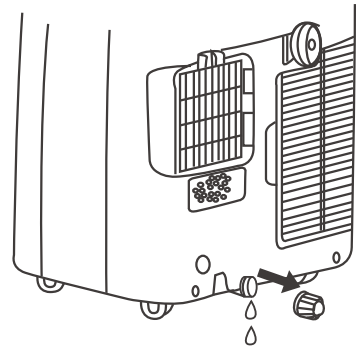

■ ■ Troubleshooting

Problem	Cause	Solution
The appliance does not come on	There is no current	Wait
	It is not plugged into the mains	Plug into the mains
	The internal safety device has tripped	Wait 30 minutes, if the problem persists, contact your service center
The appliance works for a short time only	Here are bends in the air exhaust hose	Position the air exhaust hose correctly, keeping it as short and free of curves as possible to avoid bottlenecks
	Something is preventing the air from being discharged	Check and remove any obstacles obstructing air discharge
The appliance works but does not cool the room	Windows, doors and / or curtains open	Close doors, windows and curtains, bearing in mind the "tips for correct use" given above
	There are heat sources in the room (oven, hairdryer, etc)	Eliminate the heat sources
	The air exhaust hose is detached from the appliance	Fit the air exhaust hose in the housing at the back of the appliance
	The technical specification of the appliance is not adequate for the room in which it is located	
During operation, there is an unpleasant smell in the room	Air filter clogged	Clean the filter as described above
The appliance does not operate for about three minutes after restarting it	The internal compressor safety device prevents the appliance from being restarted until three minutes have elapsed since it was last turned off	Wait. This delay is part of normal operation
The following message appears on the display: PF/Ft	The appliance has a self diagnosis system to identify a number of malfunctions	See the SELF-DIAGNOSIS Chapter



Model: TAC-10CPD/DM7
Company:Garvee Innovation Inc.
Address : 4215 E Airport Dr, Ontario, CA, USA
Email:support@garvee.com
Website:<http://www.garvee.com>

Made in China



Energy Verified
Rendement
Énergétique Vérifié



LISTED
ROOM AIR
CONDITIONER
SA13524