

# Instruction Manual

## COMMERCIAL LIGHT DUTY ELECTRIC WATER HEATERS

Compact 6/10/15/20 Models  
Lowboy 30/40/50 Models  
Tall 30/40/52 Models

INSTALLATION - OPERATION - SERVICE - MAINTENANCE



Thank you for buying this energy efficient water heater. We appreciate your confidence in our products.

### **WARNING**



Read and understand this instruction manual and the safety messages herein before installing, operating or servicing this water heater.

Failure to follow these instructions and safety messages could result in death or serious injury.

This manual must remain with the water heater.

### **WARNING**



#### **Electrical Shock Hazard**

If the water heater becomes immersed in water up to or above the level of the bottom of the element doors, the heater should be examined by a qualified service agency before it is placed in operation.

**PLACE THESE INSTRUCTIONS ADJACENT TO HEATER AND NOTIFY OWNER TO KEEP FOR FUTURE REFERENCE.**

**KEEP THIS MANUAL IN THE POCKET ON HEATER FOR FUTURE REFERENCE WHENEVER MAINTENANCE ADJUSTMENT OR SERVICE IS REQUIRED.**

# CONTENTS

SAFE INSTALLATION, USE, AND SERVICE .....	3	Insulation Blankets .....	12
Important Definitions .....	3	Temperature-Pressure Relief Valve.....	12
APPROVALS .....	3	Closed Water Systems .....	13
GENERAL SAFETY INFORMATION.....	4	Thermal Expansion .....	13
Precautions .....	4	Electrical .....	13
Limiting the Risk of Scalding .....	4	START UP .....	15
Hydrogen Gas (Flammable).....	4	Limiting the Risk of Scalding .....	15
Hazard Messages .....	4	Filling the Water Heater.....	15
INTRODUCTION .....	7	Initial Start Up.....	15
Preparing for the Installation .....	7	Draining the Water Heater.....	15
FEATURES AND COMPONENTS.....	8	TEMPERATURE REGULATION.....	16
Model and Rating .....	9	Temperature Adjustment .....	16
INSTALLATION CONSIDERATIONS .....	10	MAINTENANCE .....	18
Locating the Water Heater.....	10	Draining and Flushing .....	18
Clearances .....	11	Lime Scale Removal .....	18
INSTALLATION .....	12	Anode Maintenance .....	19
Required Ability .....	12	Temperature-Pressure Relief Valve Test .....	19
General.....	12	TROUBLESHOOTING .....	21
Contaminated Water.....	12	Checklist.....	21
Circulating Pump.....	12	Checking for Leaks.....	22
		WIRING DIAGRAM.....	23







# SAFE INSTALLATION, USE, AND SERVICE

Your safety and the safety of others is extremely important in the installation, use and servicing of this water heater. Many safety-related messages and instructions have been provided in this manual and on your own water heater to warn you and others of a potential

injury hazard. Read and obey all safety messages and instructions throughout this manual. It is very important that the meaning of each safety message is understood by you and others who install, use or service this water heater.

Many safety-related messages and instructions have been provided in this manual and on your own water heater to warn you and others of a potential injury hazard. Read and obey all safety messages and instructions throughout this manual. It is very important that the meaning of each safety message is understood by you and others who install, use, or service this water heater.

	<p>This is the safety alert symbol. It is used to alert you to potential personal injury hazards. Obey all safety messages that follow this symbol to avoid possible injury or death. Keep this manual near the water heater.</p>
---	---

	<p>DANGER indicates an imminently hazardous situation which, if not avoided, will result in injury or death.</p>
	<p>WARNING indicates a potentially hazardous situation which, if not avoided, could result in injury or death.</p>
	<p>CAUTION indicates a potentially hazardous situation which, if not avoided, could result in minor or moderate injury.</p>
	<p>CAUTION used without the safety alert symbol indicates a potentially hazardous situation which, if not avoided, could result in property damage.</p>

All safety messages will generally tell you about the type of hazard, what can happen if you do not follow the safety message, and how to avoid the risk of injury.

## IMPORTANT DEFINITIONS

- Qualified Installer or Service Agency:

Installation and service of this water heater requires ability equivalent to that of a Qualified Agency (as defined by ANSI below) in the field involved. Installation skills such as plumbing, electrical supply are required in addition to electrical testing skills when performing service.

- ANSI Z223.1 2006 Sec. 3.3.83:

“Qualified Agency” - “Any individual, firm, corporation or company that either in person or through a representative is engaged in and is responsible for (a) the installation, testing or replacement of gas piping or (b) the connection, installation, testing, repair or servicing of appliances and equipment; that is experienced in such work; that is familiar with all precautions required; and that has complied with all the requirements of the authority having jurisdiction.”

## APPROVALS



LOW LEAD  
CONTENT



# GENERAL SAFETY INFORMATION

## PRECAUTIONS

**DO NOT USE THIS WATER HEATER IF ANY PART HAS BEEN EXPOSED TO FLOODING OR WATER DAMAGE.** Immediately call a qualified service technician to inspect the water heater and to replace any part of the control system which has been under water.

If the unit is exposed to the following, do not operate heater until all corrective steps have been made by a qualified service technician.

1. External fire.
2. Damage.
3. Firing without water.

## GROUNDING INSTRUCTIONS

This water heater must be grounded in accordance with the National Electrical Code and/or local codes. These must be followed in all cases. Failure to ground this water heater properly may also cause erratic control system operation on ELECTRONIC CONTROL models.

This water heater must be connected to a grounded metal, permanent wiring system; or an equipment grounding conductor must be run with the circuit conductors and connected to the equipment grounding terminal or lead on the water heater.

## LIMITING THE RISK OF SCALDING

For a variety of reasons, water heaters can produce water that is much hotter than its temperature setting. Take precautions to prevent this higher temperature water from reaching the water fixtures.

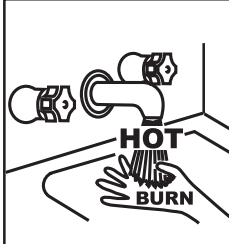
	<b>⚠ WARNING</b>
	<b>Burn Hazard</b> To reduce the risk of unusually hot water reaching the fixtures in the house, install thermostatic mixing valves at each point of use.

A properly adjusted thermostatic mixing valve at each point of use allows you to set the tank temperature to a higher setting without increasing risk of scalds. A higher temperature setting allows the tank to provide much more hot water and can help provide proper water temperatures for appliances such as dishwashers and washing machines.

## HYDROGEN GAS (FLAMMABLE)

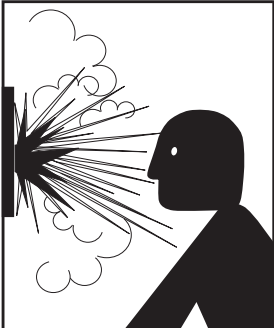
	<b>⚠ WARNING</b>
	<b>Explosion Hazard</b> <ul style="list-style-type: none"><li>• Flammable hydrogen gases may be present.</li><li>• Keep all ignition sources away from faucet when turning on hot water.</li></ul>

Hydrogen gas can be produced in a hot water system served by this heater that has not been used for a long period of time (generally two weeks or more). Hydrogen gas is extremely flammable. To reduce the risk of injury under these conditions, it is recommended that the hot water faucet be opened for several minutes at the kitchen sink before using any electrical appliance connected to the hot water system. If hydrogen is present there will probably be an unusual sound such as air escaping through the pipe as the water begins to flow. **THERE SHOULD BE NO SMOKING OR OPEN FLAME NEAR THE FAUCET AT THE TIME IT IS OPEN.**

When servicing this unit, verify the power to the unit is turned off prior to opening the control cabinet door.

## HAZARD MESSAGES

	<b>⚠ WARNING</b>
	Read and understand this instruction manual and the safety messages herein before installing, operating or servicing this water heater. Failure to follow these instructions and safety messages could result in death or serious injury. This manual must remain with the water heater.

	<b>⚠ WARNING</b>
	<b>Electrical Shock Hazard</b> If the water heater becomes immersed in water up to or above the level of the bottom of the element doors, the heater should be examined by a qualified service agency before it is placed in operation.

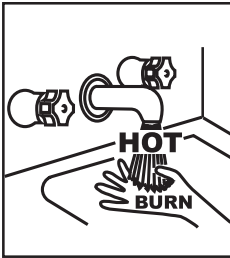

**⚠️ WARNING**

**Burn Hazard**

To reduce the risk of unusually hot water reaching the fixtures in the house, install thermostatic mixing valves at each point of use.

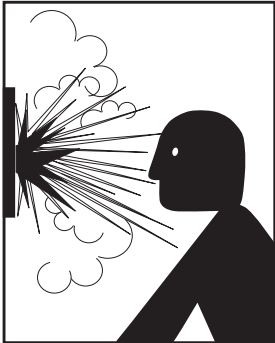

**⚠️ WARNING**

**Explosion Hazard**

- Flammable hydrogen gases may be present.
- Keep all ignition sources away from faucet when turning on hot water.



**⚠️ WARNING**

**Electrical Shock Hazard**

- Before removing any access panels or servicing the water heater, make sure the electrical supply to the water heater is turned OFF.
- Failure to follow these instructions can result in personal injury or death.

**CAUTION**

**Property Damage Hazard**

- All water heaters eventually leak.
- Do not install without adequate drainage.

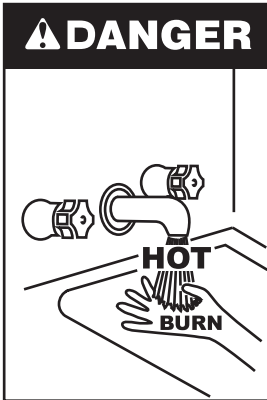

**⚠️ DANGER**

Water temperature over 125°F (52°C) can cause severe burns instantly resulting in severe injury or death.

Children, the elderly and the physically or mentally disabled are at highest risk for scald injury.

Feel water before bathing or showering.

Temperature limiting devices such as thermostatic point-of-use mixing valves must be installed when required by codes and to ensure safe temperatures at fixtures.

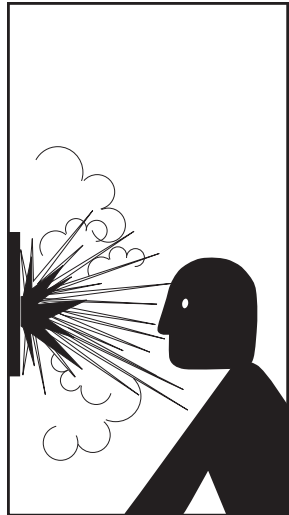

**⚠️ WARNING**

**Explosion Hazard**

- Temperature-Pressure Relief Valve must comply with *ANSI Z21.22-CSA 4.4* and *ASME* code.
- Properly sized temperature-pressure relief valve must be installed in opening provided.
- Can result in overheating and excessive tank pressure.
- Can cause serious injury or death.

**CAUTION**

**Property Damage Hazard**

- The temperature-pressure relief-valve discharge pipe must terminate at an adequate drain.



**⚠️ WARNING**

**Electrical Shock Hazard**

Full power is present whenever the cabinet door is opened, even with the pilot switch turned off.

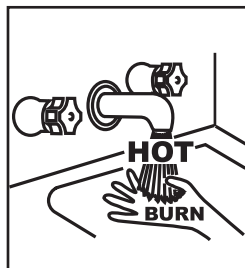

**⚠️ WARNING**

**Burn Hazard**

If you choose a higher temperature setting, install thermostatic mixing valves at each point-of-use to help avoid scalding.

**CAUTION**

**Property Damage Hazard**

To avoid water heater damage, fill tank with water before operating.



**⚠️ DANGER**

- Burn hazard.
- Hot water discharge.
- Keep hands clear of drain valve discharge.

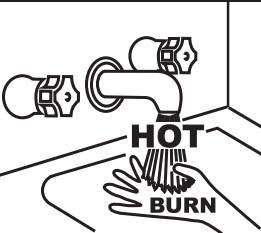
<b>⚠ DANGER</b>	
	<ul style="list-style-type: none"> <li>• Burn hazard.</li> <li>• Hot water discharge.</li> <li>• Keep clear of Temperature-Pressure Relief Valve discharge outlet.</li> </ul>

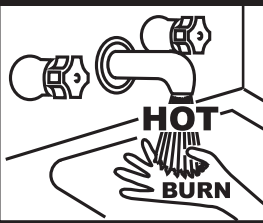
<b>⚠ DANGER</b>	
	<ul style="list-style-type: none"> <li>• Burn hazard.</li> <li>• Hot water discharge.</li> <li>• Keep clear of Temperature-Pressure Relief Valve discharge outlet.</li> </ul>

<b>CAUTION</b>	
<b>Property Damage Hazard</b>	
<ul style="list-style-type: none"> <li>• Avoid damage.</li> <li>• Inspection and replacement of anode rod required.</li> </ul>	



# INTRODUCTION

Thank You for purchasing this water heater. Properly installed and maintained, it should give you years of trouble free service.

Abbreviations Found In This Instruction Manual:

- ANSI - American National Standards Institute
- AHRI - Air-Conditioning, Heating and Refrigeration Institute
- NEC - National Electrical Code
- NFPA - National Fire Protection Association
- UL - Underwriters Laboratory

## PREPARING FOR THE INSTALLATION

<b>⚠ WARNING</b>	
	<b>Electrical Shock Hazard</b>
	<ul style="list-style-type: none"><li>• Before removing any access panels or servicing the water heater, make sure the the electrical supply to the water heater is turned OFF.</li><li>• Failure to follow these instructions can result in personal injury or death.</li></ul>

1. Read the “General Safety Information” section of this manual first and then the entire manual carefully. If you don’t follow the safety rules, the water heater may not operate safely. It could cause **DEATH, SERIOUS BODILY INJURY AND/OR PROPERTY DAMAGE**.

This manual contains instructions for the installation, operation, and maintenance of the electric water heater. It also contains warnings throughout the manual that you must read and be aware of. All warnings and all instructions are essential to the proper operation of the water heater and your safety. **READ THE ENTIRE MANUAL BEFORE ATTEMPTING TO INSTALL OR OPERATE THE WATER HEATER.**

Be sure to turn off power when working on or near the electrical system of the heater. Never touch electrical components with

wet hands or when standing in water. When replacing fuses always use the correct size for the circuit. See *Wiring Diagram* (page 23).

The model and rating plate on page 9 interprets certain markings into useful information. Both of these references should be used to identify the heater, its components and optional equipment.

2. The installation must conform with these instructions and the local code authority having jurisdiction and the requirements of the power company. In the absence of local codes, the installation must comply with the latest editions of the **National Electrical Code, NFPA 70** or the **Canadian Electrical Code CSA C22.1**. The **National Electrical Code** may be ordered from: National Fire Protection Association, 1 Batterymarch Park, Quincy, MA 02269. The **Canadian Electrical Code** is available from the Canadian Standards Association, 8501 East Pleasant Valley Road, Cleveland, OH 44131.
3. If after reading this manual you have any questions or do not understand any portion of the instructions, call the toll free number listed on the back cover (page 24) of this manual for technical assistance.

A sample rating plate is shown in *Model and Rating* (page 9). In order to expedite your request, please have full model and serial number available for the technician.

4. Carefully plan your intended placement of the water heater. Examine the location to ensure the water heater complies with *Locating the Water Heater* (page 10).

Installation and service of this water heater requires ability equivalent to that of a licensed tradesman or qualified agency in the field involved. Plumbing and electrical work are required. See *Important Definitions* (page 3).



# FEATURES AND COMPONENTS

This page shows typical water heater installations by model designations.

Printed on 7/25/2022 7:17 AM CT

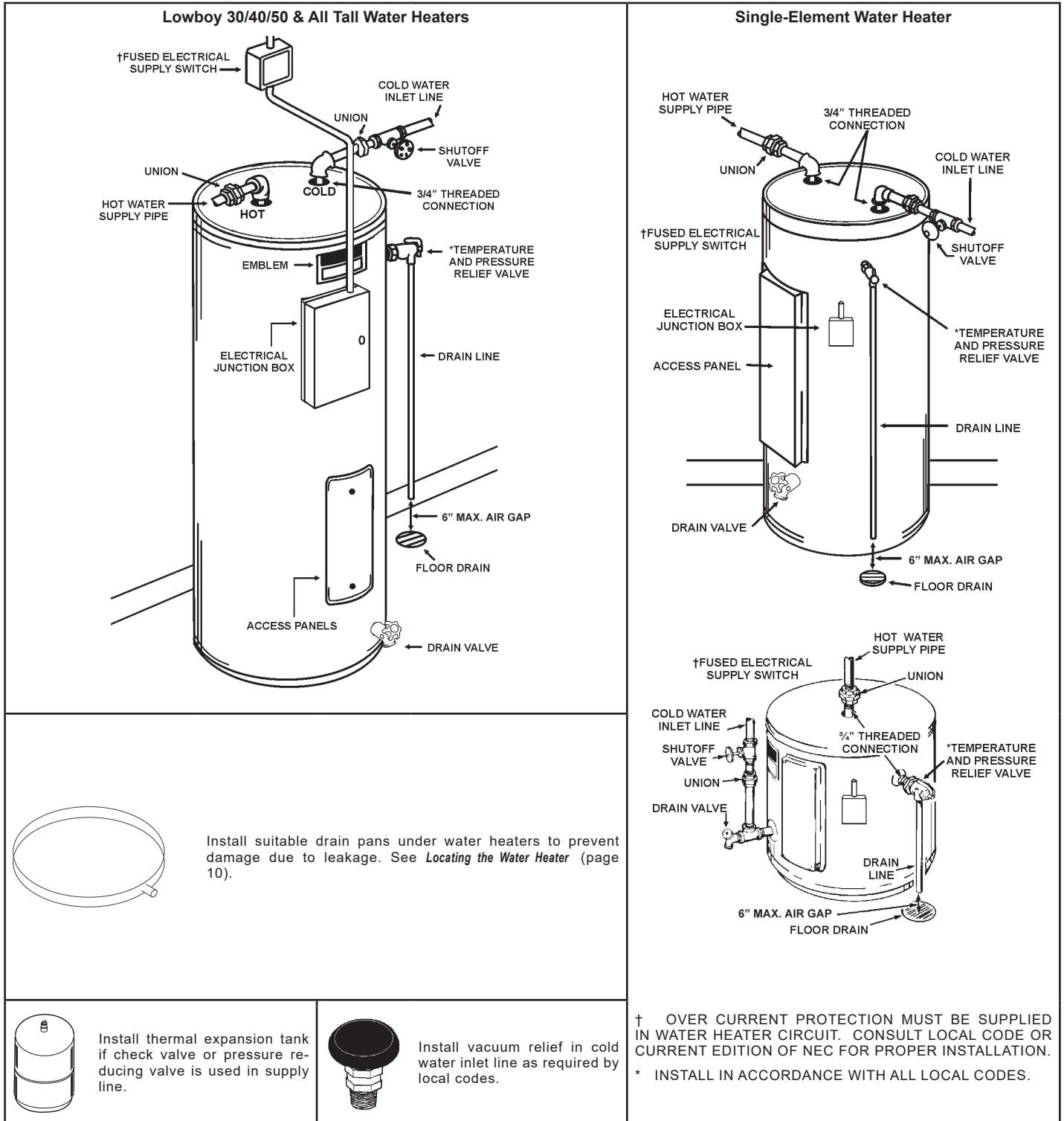



Figure 1. Typical Water Heater Installations



Table 1. Recovery Capacities													
Element Wattage (Upper/Lower)	Input kW	U.S. Gallons/Hr and Liters/Hr at Temperature Rise Indicated											
		F°	36F°	40F°	54F°	60F°	72F°	80F°	90F°	100F°	108F°	120F°	126F°
		C°	20C°	22.2C°	30C°	33.3C°	40C°	44.4C°	50C°	55.5C°	60C°	66.6C°	70C°
<b>NON-SIMULTANEOUS</b>													
/1500		GPH	17	15	11	10	8	8	7	6	6	5	5
	1.5	LPH	64	58	43	38	32	29	26	23	21	19	18
/2000		GPH	23	20	15	14	11	10	9	8	8	7	6
	2.0	LPH	85	77	57	51	43	38	34	31	28	26	24
/2500		GPH	28	25	19	17	14	13	11	10	9	8	8
	2.5	LPH	107	96	71	64	53	48	43	38	36	32	30
3000/3000		GPH	34	30	23	20	17	15	14	12	11	10	10
	3.0	LPH	128	115	85	77	64	58	51	46	43	38	37
4000/4000		GPH	45	41	30	27	23	20	18	16	15	14	13
	4.0	LPH	170	153	114	102	85	77	68	61	57	51	49
4500/4500		GPH	51	46	34	30	25	23	20	18	17	15	14
	4.5	LPH	192	173	128	115	96	86	77	69	64	58	55
5000/5000		GPH	56	51	38	34	28	25	23	20	19	17	16
	5.0	LPH	213	192	142	128	107	96	85	77	71	64	61
6000/6000		GPH	68	61	45	41	34	30	27	24	23	20	19
	6.0	LPH	256	230	170	153	128	115	102	92	85	77	73
<b>SIMULTANEOUS OPERATION</b>													
3000/3000		GPH	68	61	45	41	34	30	27	24	23	20	19
	6	LPH	256	230	170	153	128	115	102	92	85	77	73
4000/4000		GPH	90	81	60	54	45	41	36	32	30	27	26
	8	LPH	341	307	227	205	170	153	136	123	114	102	97
4500/4500		GPH	101	91	68	61	51	46	41	36	34	30	29
	9	LPH	384	345	256	230	192	173	153	138	128	115	110
5000/5000		GPH	113	101	75	68	56	51	45	41	38	34	32
	10	LPH	426	384	284	256	213	192	170	153	142	128	122
6000/6000		GPH	135	122	90	81	68	61	54	49	45	41	39
	12	LPH	511	460	341	307	256	230	205	184	170	153	146
Recovery capacities at 100° F rise equal: for non-simultaneous element operation = 4.1 gal. x kW of one element; for simultaneous element operation = 4.1 gal. x 2/3 KW of both elements. For other rises multiply element KW as previously explained by 410 and divide by temperature rise. Full load current for single phase = total watts : voltage.													

**MODEL AND RATING**

		<b>ELECTRIC STORAGE TANK WATER HEATER</b>					
MODEL NUMBER		SERIAL NUMBER			ITEM ID/PART NUMBER		
VOLTS - AC	PHASE	WATTS UPPER	WATTS LOWER	TOTAL WATTS CONNECTED	CAPACITY US GAL.	MAX WORKING PRESSURE	
ALTERNATE RATINGS							
VOLTS - AC	WATTS UPPER	WATTS LOWER	TOTAL WATTS CONNECTED		CIRCUIT		



# INSTALLATION CONSIDERATIONS

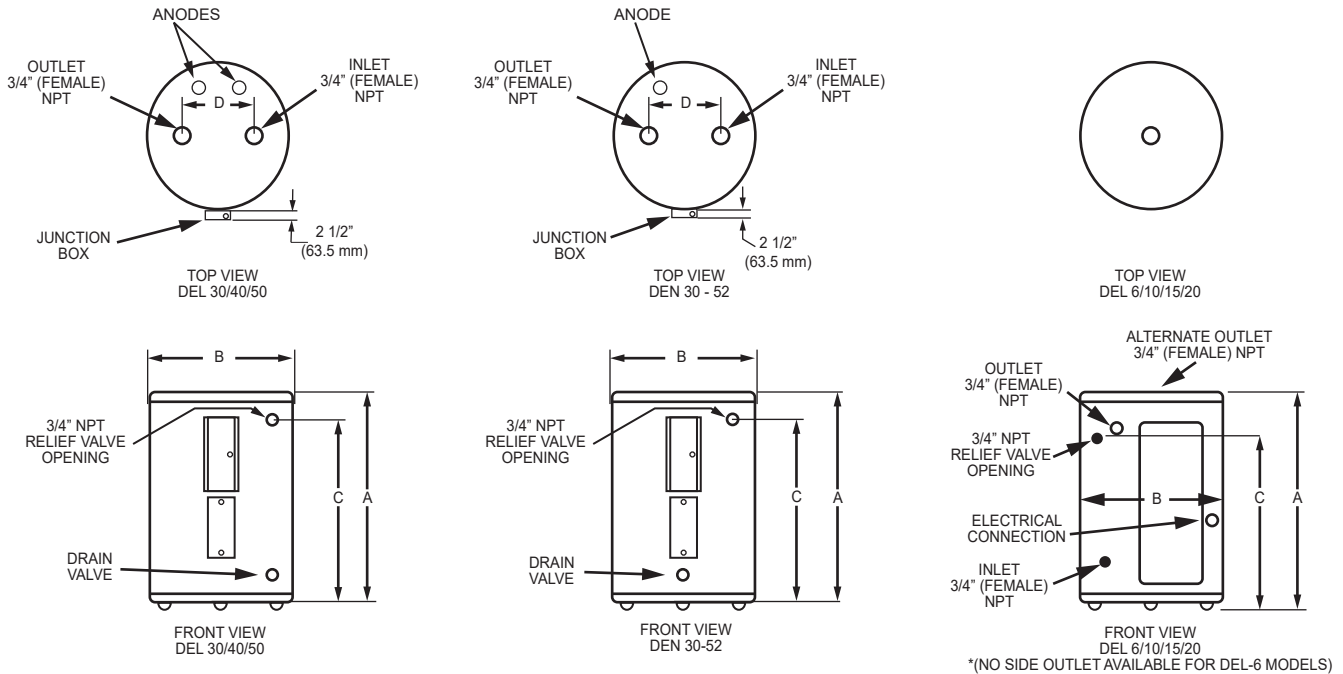

Figure 2. Rough-In Dimensions

Models Dimensions	No. of Elements	Tank Capacity		A		B		C		D		Approx. Shipping Weight	
		US Gals	Liters	Inches	mm	Inches	mm	Inches	mm	Inches	mm	Lbs.	kg.
Compact-6	1	6	23	15.50	394	14.25	362	11.00	279	-	-	35	15.9
Compact-10	1	10	38	18.25	464	18.00	457	12.50	318	-	-	54	24.5
Compact-15	1	15	57	26.00	660	18.00	457	20.50	521	-	-	58	26.3
Compact-20	1	20	76	22.25	565	21.75	552	15.38	391	-	-	73	33.1
Lowboy-30	2	36	136	32.00	813	24.00	610	24.00	610	8.00	203	118	53.5
Lowboy-40	2	38	144	32.00	813	23.00	584	24.00	610	8.00	203	118	53.5
Lowboy-50	2	51	193	36.00	914	26.50	673	25.00	635	8.00	203	172	78.0
Tall-30	2	40	151	49.75	1264	20.50	521	53.25	1353	8.00	203	118	53.5
Tall-40	2	50	189	59.00	1499	20.50	521	51.25	1302	8.00	203	125	56.7
Tall-52	2	55	208	56.50	1435	24.00	610	48.50	1232	8.00	203	145	65.8

## LOCATING THE WATER HEATER

# CAUTION

## Property Damage Hazard

- All water heaters eventually leak.
- Do not install without adequate drainage.

The water heater should be located as close as possible to/ or centralized to the water piping system. The water heater should be located in an area not subject to freezing temperatures.

The water heater should be located in an area where leakage of the tank or connections will not result in damage to the area adjacent to the heater or to lower floors of the structure.

When such locations cannot be avoided, a suitable drain pan should be installed under the heater.

Such pans should be at least two inches deep, have a minimum length and width of at least two inches greater than the diameter of the heater and should be piped to an adequate drain.

Drain pans suitable for these water heaters are available from your distributor or A.O. Smith Water Heater Parts Fulfillment, 125 Southeast Parkway, Franklin, TN 37068.

Water heater life depends upon water quality, water pressure and the environment in which the water heater is installed. Water heaters are sometimes installed in locations where leakage may result in property damage, even with the use of a drain pan piped to a drain. However, unanticipated damage can be reduced or prevented by a leak detector or water shut-off device used in conjunction with a piped drain pan. These devices are available from some plumbing supply wholesalers and retailers, and detect and react to leakage in various ways:



- Sensors mounted in the drain pan that trigger an alarm or turn off the incoming water to the water heater when leakage is detected.
- Sensors mounted in the drain pan that turn off the water supply to the entire home when water is detected in the drain pan.
- Water supply shut-off devices that activate based on the water pressure differential between the cold water and hot water pipes connected to the water heater.
- Devices that will turn off the gas supply to a gas water heater while at the same time shutting off its water supply.

### CLEARANCES

---

A minimum clearance of 4" must be allowed for access to replaceable parts such as thermostats, drain valve and relief valve.

Adequate clearance for servicing this water heater should be considered before installation, such as changing the anodes, etc.

 <b>WARNING</b>	
	<b>Electrical Shock Hazard</b>
	If the water heater becomes immersed in water up to or above the level of the bottom of the element doors, the heater should be examined by a qualified service agency before it is placed in operation.



# INSTALLATION

## REQUIRED ABILITY

Installation and service of this water heater requires ability equivalent to that of a qualified installer or service agency in the field involved. See *Important Definitions* (page 3). Plumbing and electrical work is required.

## GENERAL

The installation must conform with these instructions and the local code authority having jurisdiction and the requirements of the power company. In the absence of local codes, the installation must comply with the latest editions of the *National Electrical Code, NFPA 70* or the *Canadian Electrical Code CSA C22.1*. The *National Electrical Code* may be ordered from: National Fire Protection Association, 1 Batterymarch Park, Quincy, MA 02269. The *Canadian Electrical Code* is available from the Canadian Standards Association, 8501 East Pleasant Valley Road, Cleveland, OH 44131.

**Do NOT** test electrical system before heater is filled with water, follow the **START UP** procedure in the **OPERATION** section of this manual.

The principal components of the heater are identified in the *Features and Components* (page 8).

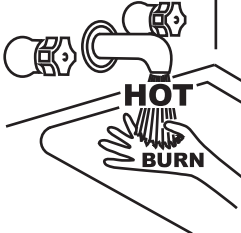
<b>⚠ DANGER</b>	Water temperature over 125°F (52°C) can cause severe burns instantly resulting in severe injury or death.
	Children, the elderly and the physically or mentally disabled are at highest risk for scald injury.
	Feel water before bathing or showering.
	Temperature limiting devices such as thermostatic point-of-use mixing valves must be installed when required by codes and to ensure safe temperatures at fixtures.

## MIXING VALVE USAGE

Water heaters are intended to produce hot water. Water heated to a temperature which will satisfy space heating, clothes washing, dish washing, cleaning and other sanitizing needs can scald and permanently injure you upon contact. Some people are more likely to be permanently injured by hot water than others. These include the elderly, children, the infirm, or physically/developmentally disabled. If anyone using hot water in your home fits into one of these groups or if there is a local code or state law requiring a maximum water temperature at the hot water tap, then you must take special precautions. In addition to using the lowest possible temperature setting that satisfies your hot water needs, a means such as a MIXING VALVE, should be used at the hot water taps used by these people or at the water heater.

**MIXING VALVES** for reducing point of use temperature are available and are to be set at a maximum of 125 degree F. Consult a qualified installer or service agency. Follow all manufacturer's Instructions for installation of these valves. Before changing the factory setting on the thermostat, read the "Temperature Regulation" section in this manual.

## ⚠ WARNING

### Toxic Chemical Hazard

- Do not connect to non-potable water system.

## CONTAMINATED WATER

This water heater shall not be connected to any heating system(s) or component(s) used with a non-potable water heating appliance.

Toxic chemicals, such as those used for boiler treatment shall not be introduced into this system.

## CIRCULATING PUMP

Field installed circulating pumps should be of all bronze construction.

## INSULATION BLANKETS

Insulation blankets are available to the general public for external use on electric water heaters but are not necessary with this product. The purpose of an insulation blanket is to reduce the standby heat loss encountered with storage tank heaters.

Should you choose to apply an insulation blanket to this heater, you should follow these instructions below. Failure to follow these instructions can result in fire, serious personal injury, or death.

- Do not cover the temperature and pressure relief (T & P) valve with an insulation blanket.
- Do not cover the instruction manual. Keep it on the side of the water heater or nearby for future reference.
- Do obtain new warning and instruction labels for placement on the blanket directly over the existing labels.

## TEMPERATURE-PRESSURE RELIEF VALVE

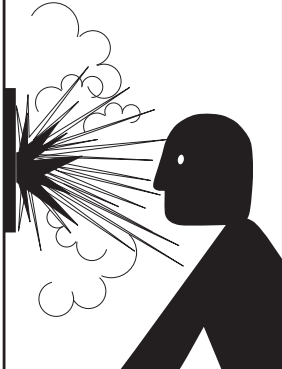
	<b>⚠ WARNING</b>
	<b>Explosion Hazard</b>
	<ul style="list-style-type: none"> <li>• Temperature-Pressure Relief Valve must comply with <i>ANSI Z21.22-CSA 4.4</i> and <i>ASME</i> code.</li> <li>• Properly sized temperature-pressure relief valve must be installed in opening provided.</li> <li>• Can result in overheating and excessive tank pressure.</li> <li>• Can cause serious injury or death.</li> </ul>

This water heater is provided with a properly rated/sized and certified combination temperature - pressure relief valve by the manufacturer. The valve is certified by a nationally recognized testing laboratory that maintains periodic inspection of production of listed equipment of materials as meeting the requirements for *Relief Valves for Hot Water Supply Systems, ANSI Z21.22 • CSA 4.4*, and the code requirements of *ASME*.

If replaced, the new valve must meet the requirements of local codes, but not less than a combination temperature and pressure relief valve rated/sized and certified as indicated in the above paragraph. The new valve must be marked with a maximum set pressure not to exceed the marked hydrostatic working pressure of the water heater (150 psi = 1,035 kPa) and a discharge capacity not less than the water heater Btu/hr or KW input rate as shown on the water heater's model rating plate.

For safe operation of the water heater, the temperature and pressure relief valve must not be removed from its designated opening nor plugged. The temperature-pressure relief valve must be installed directly into the fitting of the water heater designed for the relief valve. Install discharge piping so that any discharge will exit only within 6 inches (15.2 cm) above, or at any distance below the structural floor. Be certain that no contact is made with any live electrical part. The discharge opening must not be blocked or reduced in size under any circumstances. Excessive length, over 30 feet (9.14 m), or use of more than four elbows can cause restriction and reduce the discharge capacity of the valve.

No valve or other obstruction is to be placed between the relief valve and the tank. Do not connect discharge piping directly to the drain unless a 6" (15.2 cm) air gap is provided. To prevent bodily injury, hazard to life, or property damage, the relief valve must be allowed to discharge water in adequate quantities should circumstances demand. If the discharge pipe is not connected to a drain or other suitable means, the water flow may cause property damage.

<b>CAUTION</b>
<b>Property Damage Hazard</b>
<ul style="list-style-type: none"> <li>• The temperature-pressure relief-valve discharge pipe must terminate at an adequate drain.</li> </ul>

The Discharge Pipe:

- Shall not be smaller in size than the outlet pipe size of the valve, or have any reducing couplings or other restrictions.
- Shall not be plugged or blocked.
- Shall be of material listed for hot water distribution.
- Shall be installed so as to allow complete drainage of both the temperature-pressure relief valve and the discharge pipe.
- Must terminate a maximum of six inches above a floor drain or external to the building. In cold climates, it is recommended that the discharge pipe be terminated at an adequate drain inside the building.
- Shall not have any valve or other obstruction between the relief valve and the drain.

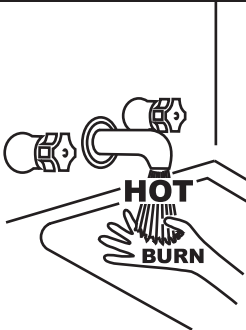
<b>⚠ DANGER</b>	<p>Water temperature over 125°F (52°C) can cause severe burns instantly resulting in severe injury or death.</p> <p>Children, the elderly and the physically or mentally disabled are at highest risk for scald injury.</p> <p>Feel water before bathing or showering.</p> <p>Temperature limiting devices such as thermostatic point-of-use mixing valves must be installed when required by codes and to ensure safe temperatures at fixtures.</p>
	

The temperature-pressure relief valve must be manually operated at least once a year. Caution should be taken to ensure that (1) no

one is in front of or around the outlet of the temperature-pressure relief valve discharge line, and (2) the water manually discharged can cause bodily injury or property damage because the water may be extremely hot. If after manually operating the valve, it fails to completely reset and continues to release water, immediately close the cold water inlet to the water heater, follow the draining instructions in this manual, and replace the temperature-pressure relief valve with a properly rated/sized new one.

If you do not understand these instructions or have any questions regarding the temperature-pressure relief valve call the toll free number listed on the back cover (page 24) of this manual for technical assistance.

### CLOSED WATER SYSTEMS

Water supply systems may, because of code requirements or such conditions as high line pressure, among others, have installed devices such as pressure reducing valves, check valves, and back flow preventers. Devices such as these cause the water system to be a closed system.

### THERMAL EXPANSION

As water is heated, it expands (thermal expansion). In a closed system the volume of water will grow when it is heated. As the volume of water grows there will be a corresponding increase in water pressure due to thermal expansion. Thermal expansion can cause premature tank failure (leakage). This type of failure is not covered under the limited warranty. Thermal expansion can also cause intermittent temperature-pressure relief valve operation: water discharged from the valve due to excessive pressure build up. This condition is not covered under the limited warranty. The temperature-pressure relief valve is not intended for the constant relief of thermal expansion.

A properly sized thermal expansion tank should be installed on all closed systems to control the harmful effects of thermal expansion. Contact a local plumbing service agency to have a thermal expansion tank installed.

### ELECTRICAL

<b>⚠ WARNING</b>	
<b>Electrical Shock Hazard</b>	
	<ul style="list-style-type: none"> <li>• Before removing any access panels or servicing the water heater, make sure the electrical supply to the water heater is turned OFF.</li> <li>• Failure to follow these instructions can result in personal injury or death.</li> </ul>

### GENERAL

The installation must conform with these instructions and the local code authority having jurisdiction and the requirements of the power company. In the absence of local codes, the installation must comply with the current editions of the *National Electrical Code*, *NFPA 70* or the *Canadian Electrical Code CSA C22.1*.

An electrical ground is required to reduce risk of electrical shock or possible electrocution. The water heater should be connected to a separate grounded branch circuit with over-current protection



and disconnect switch. The water heater should be grounded in accordance with national and local codes.

Voltage applied to the heater should not vary more than +5% to -10% of the model and rating plate marking for satisfactory operation.

**DO NOT ENERGIZE THE BRANCH CIRCUIT FOR ANY REASON BEFORE THE HEATER TANK IS FILLED WITH WATER. DOING SO WILL CAUSE THE HEATING ELEMENTS TO BURN OUT AND VOID WARRANTY.**

The factory wiring is attached to a terminal block within the external junction box unit. The branch circuit is connected to the terminal block within this junction box. The water heater should be connected to a separate, grounded, branch circuit with over-current protection and disconnect switch. The water heater should be grounded in accordance with national and local codes.

### BRANCH CIRCUIT

The branch circuit wire size should be established through reference to the current edition of NFPA-70, the National Electrical Code or other locally approved source in conjunction with the heater amperage rating. For convenience, portions of the wire size tables from the Code are reproduced here. The branch circuit should be sized at 125 percent of the heater rating and further increase wire size as necessary to compensate for voltage drop in long runs.

### CALCULATING AMPERAGE/OVER-CURRENT PROTECTION

The heaters come from the factory in two configurations:

- Two wire C-2 circuit for single element heater equipped with a high limit control, single phase power input.
- Four wire A-8 circuit for dual element heater equipped with two high limit controls, single phase or three phase power input.

The heater with dual elements is factory wired for connection to a three wire, three-phase delta branch circuit, non-simultaneous operation. In addition a ground conductor is required.

Element connection is for non-simultaneous operation. This means only one element at a time operates. The wiring diagram shows the heater may be field converted to simultaneous element operation by moving the red wire on "J" terminal to L1. See *Wiring Diagram* (page 23). It is then possible for both elements to operate at once as determined by the thermostats. Regardless of element connection the heater operates in an "unbalanced" fashion.

The heater may be field converted to single-phase operation by moving the wire on L3 of the terminal block to L2. L3 is not used. See *Wiring Diagram* (page 23).

The heater, now in single-phase non-simultaneous operation, may be field-converted to single phase simultaneous operation by moving the red wire on terminal "J" to L1. See *Wiring Diagram* (page 23).

This is an example of calculating heater amperage for both types of element operation. From this, the branch circuit conductor and over-current protection sizing can be established.

The example is of a three-phase 240 volt unit with two, 6 kw elements. The notations are for units field converted to single-phase. Check the heater model and rating plate for actual specifications and substitute those values in the following.

Non-simultaneous: (Factory wired)	Simultaneous: (Field conversion)
3000 : 240 = 12.5 amps*	3000 : 240 = 12.5 amps* 12.5 x 1.73 = 21.6 amps
*NOTE: as a single-phase non-simultaneous unit.	*NOTE: as a single-phase simultaneous unit the total is: 12.5 x 2 = 25 amps

The rating of the over-current protection should be computed on the basis of 125 percent of the total connected load amperage. Where the standard ratings and settings do not correspond with this computation, the next higher standard rating or setting should be selected.

### PORTION OF TABLE 310-16 (NFPA-70) FOLLOWS:

Allowable Ampacities of Insulated Copper Conductors. Not more than three conductors in Raceway or Cable or Direct Burial (Based on Ambient Temperature of 30° C, 86° F).

These ampacities relate only to conductors described in *Table 310-13 in Code*.

For ambient temperatures over 30° C (86° F), see *Correction Factors, Note 13 in Code*.

Size	Temperature Rating of Conductor See Table 310-13 in Code	
	60°C (140°F)	75°C (167°F)
AMG MCM	Types: RUW, (14-2), T, TW, UF	Types: RH, RHW, RUH, (14-2), THW, THWN, XHHW, USE
18	---	---
16	---	---
14	15	15
12	20	20
10	30	30
8	40	45
6	55	65
4	70	85
3	80	100

### PORTION OF TABLE 310-18 FOLLOWS:

Allowable Ampacities of Insulated Aluminum and Copper -Clad Aluminum Conductors.

Not more than three conductors in Raceway or Cable or Direct Burial (Based on Ambient Temperature of 30° C, 86° F. These ampacities relate only to conductors described in *Table 310-13 in Code*.

For ambient temperatures over 30° C (86° F), see *Correction Factors, Note 13 in Code*.

Size	Temperature Rating of Conductor See Table 310-13 in Code	
	60°C (140°F)	75°C (167°F)
AMG MCM	Types: RUW, (14-2), T, TW, UF	Types: RH, RHW, RUH, (14-2), THW, THWN, XHHW, USE
12	15	15
10	25	25
8	30	40
6	40	50
4	55	65
3	65	75
2	75	90
1	85	100



# START UP

See *Features and Components* (page 8) for the location of components mentioned in the instructions that follow.

NEVER turn on power to the water heater without being certain the water heater is filled with water and a temperature and pressure relief valve is installed in the relief valve opening.

**DO NOT TEST ELECTRICAL SYSTEM BEFORE HEATER IS FILLED WITH WATER. FOLLOW FILLING AND START-UP INSTRUCTIONS IN OPERATION SECTION.**

1. Turn off the electrical disconnect switch.
2. Close the water heater drain valve.
3. Open a nearby hot water faucet to permit the air in the system to escape.
4. Fully open the cold water inlet pipe valve allowing the heater and piping to be filled.
5. Close the hot water faucet as water starts to flow. The heater is now ready for STARTUP and TEMPERATURE REGULATION.

## INITIAL START UP

The following checks should be made by the installer when the heater is placed into operation for the first time.

1. Turn off the electrical disconnect switch.
2. Open the front panel or top access cover, check all water and electrical connections for tightness. Also check connections on top and or sides of heater. Repair water leaks and tighten electrical connections as necessary.
3. Depress the red manual reset button on each Thermostat/ECO combination control. See *Temperature Regulation* (page 16)
4. Turn on the electrical disconnect switch.
5. Observe the operation of the electrical components during the first heating cycle. Use care as the electrical circuits are energized.
6. Close the front panel or top access cover.

Temperature control and contactor operation should be checked by allowing heater to come up to temperature and shut off automatically. Use care as the electrical circuits are energized.

## DRAINING THE WATER HEATER

The water heater must be drained if it is to be shut down and exposed to freezing temperatures. Maintenance and service procedures may also require draining the heater.

1. Turn off the electrical disconnect switch.
2. Open a hot water valve until the water is cool, then close the supply water inlet valve to heater.
3. Attach hose to outlet opening of drain valve and direct end to drain.
4. Open a nearby hot water faucet and the heater drain valve.
5. If the heater is being drained for an extended shutdown, it is suggested the drain valve be left open during this period. The hose may be removed.

Follow the instructions in *Filling the Water Heater* (page 15) when restoring hot water service.

<b>⚠ DANGER</b>	
	<ul style="list-style-type: none"> <li>• Burn hazard.</li> <li>• Hot water discharge.</li> <li>• Keep hands clear of drain valve discharge.</li> </ul>

<b>⚠ WARNING</b>	
	<p><b>Electrical Shock Hazard</b></p> <p>Full power is present whenever the cabinet door is opened, even with the pilot switch turned off.</p>

## LIMITING THE RISK OF SCALDING

For a variety of reasons, water heaters can produce water that is much hotter than its temperature setting. Take precautions to prevent this higher temperature water from reaching the water fixtures.

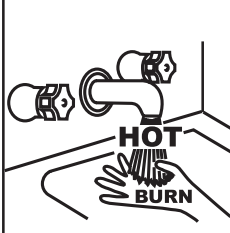
<b>⚠ WARNING</b>	
	<p><b>Burn Hazard</b></p> <p>To reduce the risk of unusually hot water reaching the fixtures in the house, install thermostatic mixing valves at each point of use.</p>

A properly adjusted thermostatic mixing valve at each point of use allows you to set the tank temperature to a higher setting without increasing risk of scalds. A higher temperature setting allows the tank to provide much more hot water and can help provide proper water temperatures for appliances such as dishwashers and washing machines.

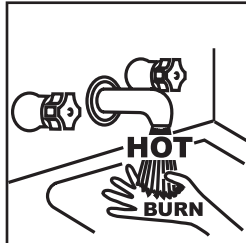
<b>⚠ WARNING</b>	
	<p><b>Burn Hazard</b></p> <p>If you choose a higher temperature setting, install thermostatic mixing valves at each point-of-use to help avoid scalding.</p>

## FILLING THE WATER HEATER

<b>CAUTION</b>	
<b>Property Damage Hazard</b>	
To avoid water heater damage, fill tank with water before operating.	



# TEMPERATURE REGULATION

## ⚠ DANGER

Water temperature over 125°F (52°C) can cause severe burns instantly resulting in severe injury or death.

Children, the elderly and the physically or mentally disabled are at highest risk for scald injury.

Feel water before bathing or showering.

Temperature limiting devices such as thermostatic point-of-use mixing valves must be installed when required by codes and to ensure safe temperatures at fixtures.

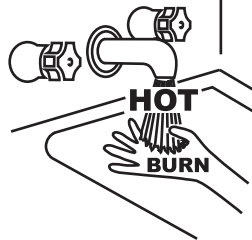

Water Temperature °F (°C)	Time for 1st Degree Burn (Less Severe Burns)	Time for Permanent Burns 2nd & 3rd Degree (Most Severe Burns)
110 (43)	(normal shower temp.)	
116 (47)	(pain threshold)	
116 (47)	35 minutes	45 minutes
122 (50)	1 minute	5 minutes
131 (55)	5 seconds	25 seconds
140 (60)	2 seconds	5 seconds
149 (65)	1 second	2 seconds
154 (68)	instantaneous	1 second

(U.S. Government Memorandum, C.P.S.C., Peter L. Armstrong, Sept. 15, 1978)

**THE WATER HEATER IS EQUIPPED WITH AN ADJUSTABLE THERMOSTAT TO CONTROL WATER TEMPERATURE. HOT WATER AT TEMPERATURES DESIRED FOR AUTOMATIC DISHWASHER AND LAUNDRY USE CAN CAUSE SCALDS RESULTING IN SERIOUS PERSONAL INJURY AND/OR DEATH. THE TEMPERATURE AT WHICH INJURY OCCURS VARIES WITH THE PERSON'S AGE AND TIME OF EXPOSURE. THE SLOWER RESPONSE TIME OF CHILDREN, AGED OR DISABLED PERSONS INCREASES THE HAZARD TO THEM. NEVER ALLOW SMALL CHILDREN TO USE A HOT WATER TAP, OR TO DRAW THEIR OWN BATH WATER. NEVER LEAVE A CHILD OR DISABLED PERSON UNATTENDED IN A BATHTUB OR SHOWER.**

It is recommended that lower water temperatures be used to avoid the risk of scalding. It is further recommended, in all cases, that the water temperature thermostats (See Temperature Adjustment) be set for the lowest temperature which satisfies your hot water needs. This will also provide the most energy efficient operation of the water heater.

## ⚠ WARNING

### Burn Hazard

To reduce the risk of unusually hot water reaching the fixtures in the house, install thermostatic mixing valves at each point of use.

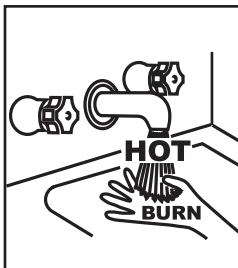

## TEMPERATURE ADJUSTMENT

A-8 circuit thermostats are adjustable from approximately 120°F (49°C) (lowest setting) to 181°F (83°C) (highest setting). The C-2 circuit thermostat is adjustable from approximately 110°F (43°C) to 170°F (77°C). These thermostats are set from the factory at approximately the 140°F (60°C) setting. The over temperature device (ECO high limit) attached to each thermostat has a manual reset.

## ⚠ WARNING

### Burn Hazard

If you choose a higher temperature setting, install thermostatic mixing valves at each point-of-use to help avoid scalding.

Temperature Adjustment shows the approximate time-to-burn relationship for normal adult skin. The thermostats on your water heater have a linear relationship between degrees of angular rotation and the corresponding change in temperature. Thus rotating the temperature adjustment indicator 30 angular degrees will result in a 10 degree Fahrenheit change in water temperature.

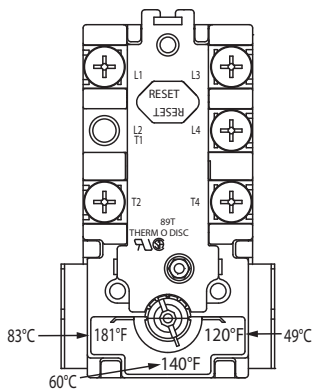

Figure 3. A-8 Thermostat

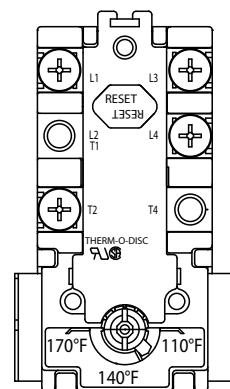



Figure 4. C-2 Thermostat

**Note:** It is not necessary to adjust the upper thermostat for a dual element unit. However, if it is adjusted above the factory set point 140°F (60°C) it is recommended that it not be set higher than the lower thermostat setting.



To change the temperature setting:

<b>⚠ WARNING</b>	
	<b>Electrical Shock Hazard</b> <ul style="list-style-type: none"><li>• Before removing any access panels or servicing the water heater, make sure the electrical supply to the water heater is turned OFF.</li><li>• Failure to follow these instructions can result in personal injury or death.</li></ul>

1. **DANGER:** Turn off the heater electrical supply. Do not attempt to adjust thermostat with power on.
2. Open the junction box door (for upper thermostat of dual element water heater only) and/or remove the (lower) thermostat access panel. Do not remove the plastic personnel protectors covering the thermostats. The thermostat is factory pre-set at 140°F (60°C).
3. Using a flat tip screwdriver, rotate the adjusting knob to the desired temperature setting.
4. Replace the covers and access panels, and turn on heater electrical supply.

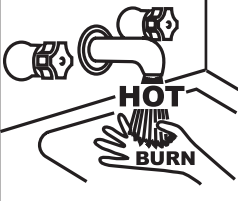
<b>⚠ WARNING</b>	
	<b>Burn Hazard</b> <p>If you choose a higher temperature setting, install thermostatic mixing valves at each point-of-use to help avoid scalding.</p>



# MAINTENANCE

**Table 5. Maintenance Schedule**

Component	Operation	Interval	Reference
Tank	Drain and Flush	Every 6 Months	See <i>Draining and Flushing</i>
Tank	Lime Scale Removal (Water Less Than 25 Grains Hard)	Not Required	N/A
Tank	Lime Scale Removal (Water Greater Than 25 Grains Hard)	Annually	See <i>Lime Scale Removal</i> .
Moving Parts	Lubrication	Not Required	N/A
Powered Anodes	Inspection/Cleaning	Annually	See <i>Anode Maintenance</i> (page 19)
T&P Valve	Test Operation	Semi Annually	See <i>Temperature-Pressure Relief Valve Test</i> . (page 19).

4. Close the cold water inlet valve to the water heater.
5. Connect a hose to the water heater drain valve and terminate it to an adequate drain.
6. Open the water heater drain valve and allow all the water to drain from the storage tank.
7. Close the water heater drain valve when all water in the storage tank has drained.
8. Close the hot water faucet opened in Step 3.
9. If the water heater is going to be shut down for an extended period, the drain valve should be left open.

## FLUSHING THE WATER HEATER STORAGE TANK

1. Turn off the electrical supply to the water heater.
2. Ensure the cold water inlet valve is open.
3. Open a nearby hot water faucet and let the water run until the water is no longer hot. Then close the hot water faucet.
4. Connect a hose to the drain valve and terminate it to an adequate drain.
5. Ensure the drain hose is secured before and during the entire flushing procedure. Flushing is performed with system water pressure applied to the water heater.
6. Open the water heater drain valve to flush the storage tank.
7. Flush the water heater storage tank to remove sediment and allow the water to flow until it runs clean.
8. Close the water heater drain valve when flushing is completed.
9. Remove the drain hose.
10. Fill the water heater. See *Filling the Water Heater* (page 15).
11. Turn on the electrical supply to place the water heater back in operation.
12. Allow the water heater to complete several heating cycles to ensure it is operating properly.

## LIME SCALE REMOVAL

When water is heated, dissolved minerals in the water such as calcium and magnesium carbonate (lime scale) become less soluble. As the water temperature rises these minerals will precipitate or “fall out” of solution.

The amount of lime scale released from water is in direct proportion to water temperature and usage. The higher the water temperature or water usage, the more lime deposits are dropped out of the water.

Water hardness also affects lime scale accumulation. With the temperature and usage being the same, hard water will release more lime scale than softer water.

Lime scale reduces heating efficiency as it accumulates inside a water heater. Heating transfer surfaces become coated with lime scale deposits which increases fuel costs to operate the water heater. Lime scale deposits can also cause rumbling and pounding noises as air molecules trapped in the lime scale escape when heated. Lime scale accumulation also reduces the life span of water heaters. For these reasons a regular schedule for deliming should be set up.

## CHEMICAL LIME SCALE REMOVAL

To dissolve and remove more stubborn lime scale deposits, UN-LIME® Professional Delimer should be used.

### **⚠ DANGER**

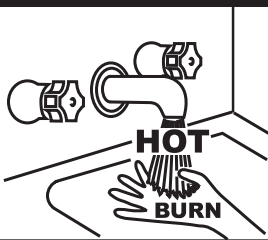

- Burn hazard.
- Hot water discharge.
- Keep clear of Temperature-Pressure Relief Valve discharge outlet.

Periodically the drain valve should be opened and the water allowed to run until it flows clean. This will help to prevent sediment buildup in the tank bottom.

Periodically check the temperature and pressure relief valve to ensure that it is in operating condition. Lift the lever at the top of the valve several times until the valve seats properly and operates freely.

Water heater maintenance includes periodic tank flushing and cleaning, and removal of lime scale from the heating element.

The heater tank is equipped with an anode rod to aid in corrosion control.

## DRAINING AND FLUSHING

It is recommended that the water heater storage tank be drained and flushed every 6 months to reduce sediment buildup. The water heater should be drained if being shut down during freezing temperatures. See *Figure 1* (page 8) for the location of the water heater components described below.

### **⚠ DANGER**

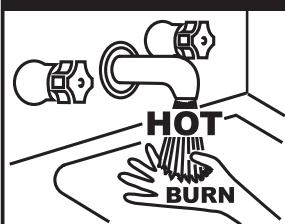

- Burn hazard.
- Hot water discharge.
- Keep hands clear of drain valve discharge.

## DRAINING THE WATER HEATER STORAGE TANK

1. Turn off the electrical supply to the water heater.
2. Ensure the cold water inlet valve is open.
3. Open a nearby hot water faucet and let the water run until the water is no longer hot.

UN-LIME® Professional Delimer is an easy to handle patented food grade acid formulated specifically for lime scale removal from all types of water using equipment. Hydrochloric base acids must not be used to delime the water heaters covered in this manual.

Follow the instructions on the UN-LIME® to delime the water heater.

**Note:** Contact Technical Support for assistance in ordering the UN-LIME® Professional Delimer.

**ANODE MAINTENANCE**

<b>CAUTION</b>
<b>Property Damage Hazard</b>
<ul style="list-style-type: none"> <li>• Avoid damage.</li> <li>• Inspection and replacement of anode rod required.</li> </ul>

The anode rod is used to protect the tank from corrosion. Most hot water tanks are equipped with an anode rod. The submerged rod sacrifices itself to protect the tank. Instead of corroding tank, water ions attack and eat away the anode rod. This does not affect water's taste or color. The rod must be maintained to keep tank in operating condition.

Anode deterioration depends on water conductivity, not necessarily water condition. A corroded or pitted anode rod indicates high water conductivity and should be checked and/or replaced more often than an anode rod that appears to be intact. Replacement of a depleted anode rod can extend the life of your water heater. Inspection should be conducted by a qualified technician, and at a minimum should be checked annually.

Artificially softened water is exceedingly corrosive because the process substitutes sodium ions for magnesium and calcium ions.

The use of a water softener may decrease the life of the water heater tank.

The anode rod should be inspected annually.

The following are typical (but not all) signs of a depleted anode rod:

- The majority of the rods diameter is less than 3/8".
- Significant sections of the support wire (approx. 1/3 or more of the anode rod's length) are visible.

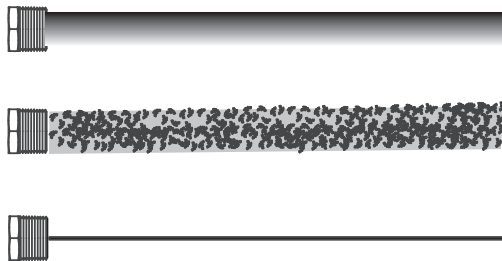

**Figure 5. Anode Depletion**

If the anode rod show signs of either or both it should be replaced.

**Note:** Whether re-installing or replacing the anode rod, check for any leaks and immediately correct if found.

Do the following to replace the anode:

1. Turn off the power supply to the water heater.

2. Shut off the water supply and open a nearby hot water faucet to depressurize the water tank.
3. Drain approximately 5 gallons of water from tank. See *Draining and Flushing* (page 18) for proper procedures. Close drain valve.
4. Remove old anode rod.
5. Use Teflon® tape or approved pipe sealant on threads and install new anode rod.
6. Turn on water supply and open a nearby hot water faucet to purge air from water system. Check for any leaks and immediately correct any if found.
7. Restart the water heater as directed in this manual. See *Figure 1* (page 8) for anode rod location.

**TEMPERATURE-PRESSURE RELIEF VALVE TEST**

<b>⚠ DANGER</b>	<ul style="list-style-type: none"> <li>• Burn hazard.</li> <li>• Hot water discharge.</li> <li>• Keep clear of Temperature-Pressure Relief Valve discharge outlet.</li> </ul>

It is recommended that the Temperature-Pressure Relief Valve should be checked to ensure that it is in operating condition every 6 months.

When checking the Temperature-Pressure Relief Valve operation, make sure that (1) no one is in front of or around the outlet of the Temperature-Pressure Relief Valve discharge line, and (2) that the water discharge will not cause any property damage, as water may be extremely hot. Use care when operating valve as the valve may be hot.

To check the temperature-pressure relief valve, lift the lever at the end of the valve several times. See *Figure 6*. The valve should seat properly and operate freely.

If after manually operating the valve, it fails to completely reset and continues to release water, immediately close the cold water inlet to the water heater and drain the water heater. See *Draining and Flushing* (page 18). Replace the Temperature-Pressure Relief Valve with a properly rated/sized new one. See *Temperature-Pressure Relief Valve* (page 12) for instructions on replacement.

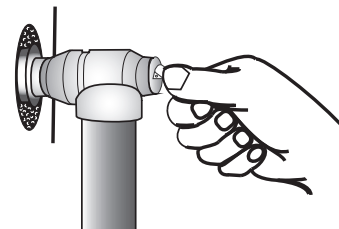

**Figure 6. Testing the Temperature-Pressure Relief Valve**

If the Temperature-Pressure Relief Valve on the water heater weeps or discharges periodically, this may be due to thermal expansion.

**Note:** Excessive water pressure is the most common cause of Temperature-Pressure Relief Valve leakage. Excessive water system pressure is most often caused by "thermal expansion" in a "closed system." See *Closed Water Systems* (page 13) and *Thermal Expansion* (page 13). The Temperature-Pressure



Relief Valve is not intended for the constant relief of thermal expansion.

Temperature-Pressure Relief Valve leakage due to pressure build up in a closed system that does not have a thermal expansion tank installed is not covered under the limited warranty. Thermal expansion tanks must be installed on all closed water systems.

**DO NOT PLUG THE TEMPERATURE-PRESSURE RELIEF VALVE OPENING. THIS CAN CAUSE PROPERTY DAMAGE, SERIOUS INJURY OR DEATH.**

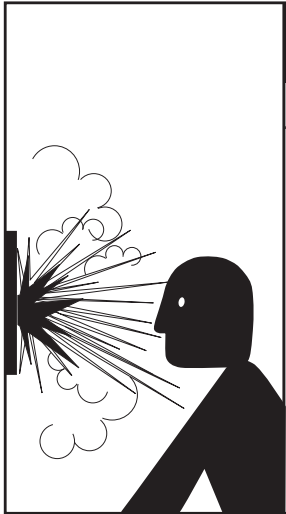
	<b>⚠ WARNING</b>
	<b>Explosion Hazard</b> <ul style="list-style-type: none"><li>• Temperature-Pressure Relief Valve must comply with ANSI Z21.22-CSA 4.4 and ASME code.</li><li>• Properly sized temperature-pressure relief valve must be installed in opening provided.</li><li>• Can result in overheating and excessive tank pressure.</li><li>• Can cause serious injury or death.</li></ul>



# TROUBLESHOOTING

## CHECKLIST

Before calling for service, check the following points to see if the cause of trouble can be identified and corrected.

Reviewing this checklist may eliminate the need of a service call and quickly restore hot water service. See *Figure 1* (page 8) to identify and locate water heater components.

<b>⚠ WARNING</b>	
	<b>Electrical Shock Hazard</b>
	<ul style="list-style-type: none"><li>• Before removing any access panels or servicing the water heater, make sure the electrical supply to the water heater is turned OFF.</li><li>• Failure to follow these instructions can result in personal injury or death.</li></ul>

## NOT ENOUGH OR NO HOT WATER

1. Be certain the electrical disconnect switch serving the water heater is in the ON position.
2. Check the fuses.
  - The electrical disconnect switch usually contains fuses.
3. If the water was excessively hot, and is now cold, the high limit switch may have activated.
  - See *Temperature Regulation* (page 16) for more information on how to reset the ECO high limit controls.
4. The capacity of the heater may have been exceeded by a large demand for hot water.
  - Large demands require a recovery period to restore water temperature.
5. Cooler incoming water temperature will lengthen the time required to heat water to the desired temperature.
6. Look for hot water leakage.
7. Sediment or pipe scale may be affecting water heater operation.

## ABNORMAL SOUNDS

8. Sediment or lime scale accumulations on the elements causes sizzling and hissing noises when the heater is operating.
  - The sounds are normal, however, the tank bottom and elements should be cleaned. See the Maintenance section of this manual.

## WATER LEAKAGE IS SUSPECTED

See *Checking for Leaks* (page 22).

1. Check to see if the heater drain valve is tightly closed.
2. If the outlet of the relief valve is leaking it may represent:
  - Excessive water temperature.
  - Faulty relief valve.
  - Excessive water pressure.
3. Excessive water pressure is the most common cause of relief valve leakage. It is often caused by a "closed system". See "Closed Water Systems" and "Thermal Expansion" in the Installation section of this manual for more information.
4. Examine the area around the element for gasket leakage.
  - Tighten the elements or, if necessary, follow the instructions in *Lime Scale Removal* (page 18) to replace the gaskets.

## IF YOU CANNOT IDENTIFY OR CORRECT THE SOURCE OF MALFUNCTION

1. Turn the power supply to the water heater off.
2. Close the supply water inlet valve to the heater.
3. Contact a Qualified Service Agency in your area. Call the toll free phone number on the back cover (page 24) of this Instruction Manual for assistance in locating a service agency in your area.

## REPLACEMENT PARTS

Call the toll free phone number on the back cover (page 24) of this Instruction Manual for assistance in locating replacement parts.. When ordering parts, specify complete model no., serial no., (see rating plate), quantity and name of part desired. Standard hardware items should be purchased locally.

## CHECKING FOR LEAKS

Use this illustration as a guide when checking for sources of water leakage. You or your dealer may be able to correct what appears to be a problem.

**Note:** Cover and insulation are shown removed to reveal tank top.

All water which appears at the water heater bottom or on the surrounding floor may be caused by condensation, loose connections or relief valve operation and leakage. Do not replace the water heater until full inspection of all potential leak points is made and corrective steps taken to stop the leak.

Leakage from other appliances, water lines or ground should also be suspected until proven otherwise. See *Water Leakage Is Suspected* (page 21).

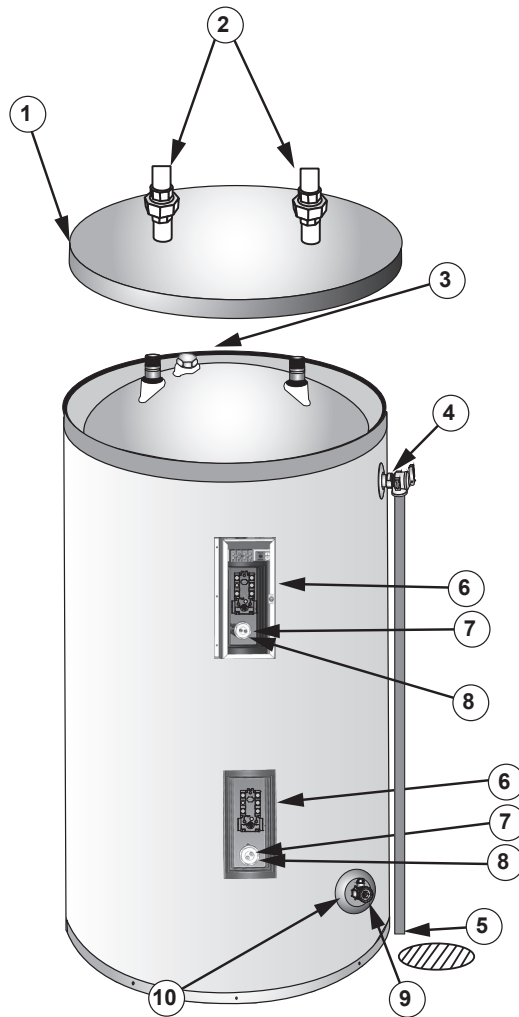

Figure 7. Leakage Checkpoints

Never use this water heater unless it is completely filled with water. To prevent damage to the tank, the tank must be filled with water. Water must flow from the hot water faucet before turning the water heater.

1. Where possible remove or lift top cover to examine threads of fittings installed into tank for evidence of leakage. Correct fitting leaks as necessary.
2. \*Condensation may be seen on pipes in humid weather or pipe connections may be leaking.
3. \*The anode rod fitting may be leaking.
4. \*The temperature-pressure relief valve may be leaking at the tank fitting.
5. Small amounts of water from temperature-pressure relief valve may be due to thermal expansion or high water pressure in your area.
6. Water on the side of the tank may be condensation due to the panel or insulation not being in place.
7. Defective element which leaks at terminals or thru flange. Replace element\*
8. Loose element/gasket leak
  - a. Screw-in type: tighten with 1-1/2" socket wrench. If leak continues, remove element\*, discard gasket and clean thread areas. Apply non-hardening Permatex Number 2 to thread areas, install new gasket and screw element into fitting until it seats. Tighten 1/2 to 3/4 turn with wrench.
  - b. Flange type: tighten screw with wrench. If leak continues remove element\* and discard gasket. Clean gasket seating areas and re-install element with new gasket. A new element may be required where threads have become rusted or damaged, preventing tightening.
9. Water from a drain valve may be due to the valve being slightly opened.
10. \*The drain valve may be leaking at the tank fitting.

Leakage from other water heaters, water lines, or ground seepage should also be checked.

\* To check where threaded portion enters tank, insert cotton swab between jacket opening and fitting. If cotton is wet, follow "Draining" instructions in the "Periodic Maintenance" section and then remove fitting. Put pipe dope or teflon tape on the threads and replace. Then follow "Filling the Water Heater" instructions in the "Installing the New Water Heater" section.

\*Contact your dealer as it is necessary to shut off electricity and drain tank to perform procedure.

### ! WARNING

Read and understand this instruction manual and the safety messages herein before installing, operating or servicing this water heater.

Failure to follow these instructions and safety messages could result in death or serious injury.

This manual must remain with the water heater.

# WIRING DIAGRAM

## A-8 CIRCUIT FOR DUAL ELEMENT HEATER

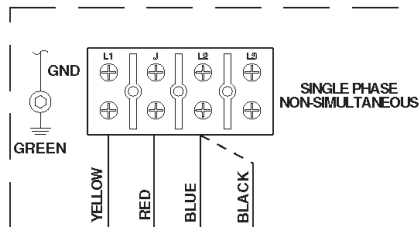
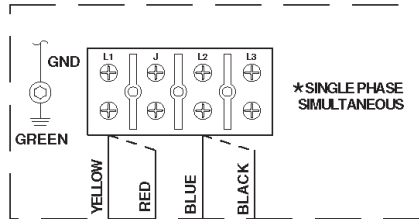
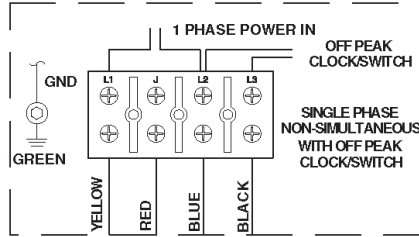
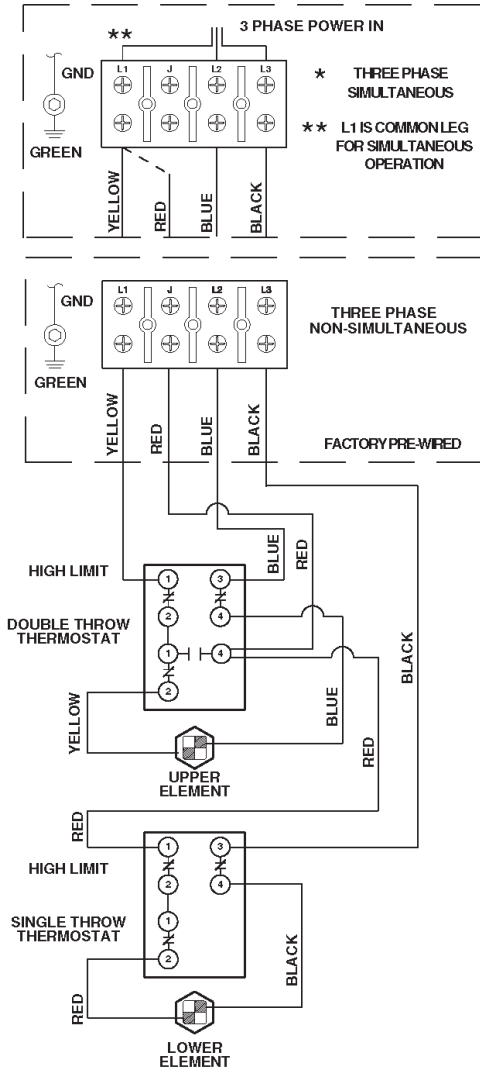

**\* NOTE:**  
MUST NOT BE CONVERTED TO SIMULTANEOUS OPERATION IF TOTAL CURRENT DRAW EXCEEDS 48 AMPS.  
:FIELD CONVERSION

## C-2 CIRCUIT FOR SINGLE ELEMENT HEATERS EQUIPPED WITH HIGH LIMIT CONTROL

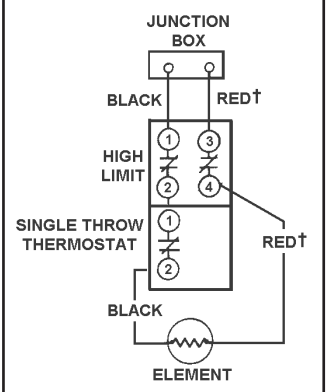

FACTORY WIRED

----- FIELD WIRING

† WHITE FOR 120V & 277V

Figure 8. A8 and C2 Circuit Wiring Diagrams

Printed on 7/25/2022 7:17 AM CT



[www.hotwater.com](http://www.hotwater.com)  
500 Tennessee Waltz Parkway, Ashland City, TN 37015  
Tech Support: 800-527-1953  
Parts: 800-433-2545  
Copyright © 2022. All rights reserved.

