

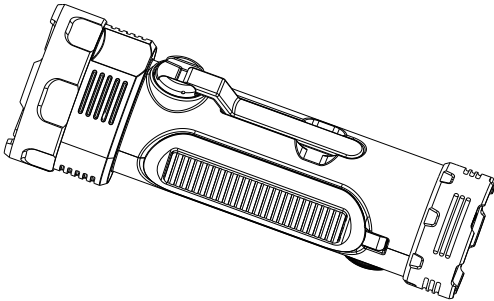

Contact our experts
support@raynic.com



CR1020 meets the NWS evaluation criteria for NWR All Hazards logo use

CR1020

Emergency Alert Radio
with AM/FM/NOAA weather/Flashlight

<https://www.raynic.com>



Version 1.2

Chapter 1 LOCATION OF CONTROLS

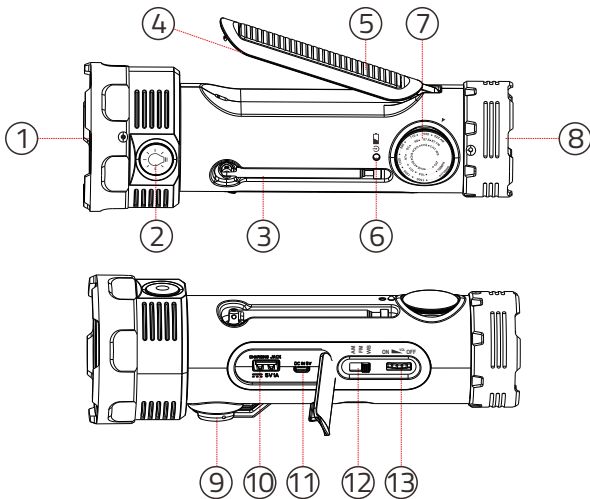

- | | |
|-----------------------------|---|
| 1. Flashlight | 8. Speaker |
| 2. Light Control Button | 9. Crank Handle |
| 3. Telescopic Antenna | 10. DC Charging Jack |
| 4. Reading Lamp | 11. USB Output Charging Jack |
| 5. Solar Panel | 12. AM/FM/WB Selector |
| 6. Battery Status Indicator | 13. Radio Switch & Volume Adjustment Gear |
| 7. Radio Rotating Disk | |

Chapter 2 POWER SUPPLY MODE

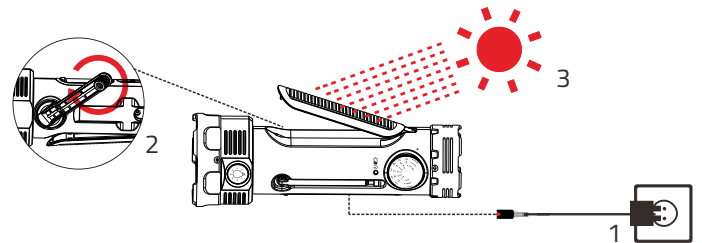

There are 4 power supply to power the radio:

1. Micro USB Adapter Charging

- (1) Connect the USB cable (included) to a regular AC power adapter (not included).
- (2) Plug the USB cable into the Micro USB port of the radio.
- (3) Plug the AC adapter into a standard 110-220V outlet.
A 5V/2A AC power adapter is highly recommended.

2. Hand Crank Charging



- Unfold the crank handle and rotate it in either direction (generating 350mA of current) for approximately 7 hours to fully charge the flashlight.
- Note: Rotate the crank handle at 2 revolutions per second and it will produce 300-350mA of power.

3. Solar Panel Charging

- The solar panel can be charged by placing it in the sunlight (do not charge indoors)
- Note: Solar panel charging will produce about 30-50mA of current, it is difficult to fill the flashlight, mostly used to maintain the rechargeable battery.

4. Rechargeable Lithium Polymer Battery

Chapter 3 BATTERY STATUS INDICATOR

| | |
|--|--|
|  Red Light | Battery is charging |
|  Green Light | The radio is on/ Battery is full charged |
|  Red Light Flash | Battery is low |

Battery is charging and radio is on at the same time, the battery status indicator will red.

Chapter 4 CHARGING PHONE or PORTABLE DIGITAL DEVICE

Connect your phone charging cable with the USB output port by opening the covered rubber flap.

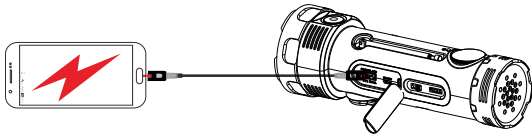

If the CR1020 has no power, you can rotate the crank handle for 8-15 minutes (The time depends on your speed of rotation). then your phone will get enough power to start up.

Note: This feature is only for charging the USB devices during emergency. Don't use it as a normal power bank. The supplied charging cable is only for charging Micro USB device, Other USB devices should be charged with original charging cable.

Chapter 8 RADIO OPERATION

(1). Turn on the Radio

Toggle the radio switch upward and hear a click to turn on the radio.

(2). Band Selector

Toggle the selector to choose the band you want to listen to, you can choose from the AM/FM/Weather Band.

AM Band: Receives all local AM stations from 520KHz - 1710KHz.

FM band: Receives all local FM stations from 87.5MHz - 108MHz.

Weather Band: Receiving all 7 weather band from NOAA. (NOAA Weather band is a service broadcast of the U.S. Government and available in all 50 states, Puerto Rico and the U.S. Virgin Islands.)

(3). Volume Control

Toggle the volume adjustment gear to adjust the volume of the radio.

(4). Tune the Radio

Select the band you want to listen to, then slowly rotate the radio rotating disk until you receive the station you want.

(5). Extend the Telescopic Antenna

When listening to the radio, extend the telescopic antenna to receive the best signal, preferably near a window or in an open area for better reception.

Note: About NOAA weather bands, you will need to determine which band receives your local weather band reports. When you change your location to another city or state, you may need to select a different band to get local reports for that location

Chapter 5 MODES FLASHLIGHT

Press the power button continuously to adjust the light brightness and mode:

- (1). High brightness (300 lumens)
- (2). Medium brightness (150 lumens)
- (3). Low brightness (75 lumens)
- (4). Strobe mode (300 lumens)
- (5). SOS light mode (300 lumens)



Note: If you press the power button interval of more than 4s, the second time to press the power button will directly off the light.

Chapter 6 SOS ALERT

In an emergency, you can turn on the SOS alert.

- (1). Press and hold the power button to turn on the SOS alert.
- (2). Press the power button again to turn off the SOS alert.



Hold Press

(In SOS mode, the SOS light will be accompanied by the SOS alarm sound at 116dB)

Chapter 7 READING LAMP

Key out the solar panel so that it is 90 degrees to the flashlight, then the reading light is on and can be used as a night light.

(6). NOAA Alert

When listening to the weather band, if the National Weather Service issues a severe weather alert, the machine will sound a 9-second SOS alert while the flashlight flashes, and then the radio will continue to play weather information.

It is recommended to use the AC adaptor to power the radio when you turn on the NOAA Alert.

Chapter 9 SPECIFICATIONS

AM: 520 - 1710KHz

FM: 87.5 - 108MHz

NOAA Weather: 162.400MHz / 162.425MHz / 162.450MHz /
162.475MHz / 162.500MHz / 162.525MHz /
162.550 MHz

Dimension: 8.66*3.03*3.03 inch

Weight: 0.74lbs

Flashlight lumens: 300LM

Reading lamp lumens: 200LM

Solar Panel Power: 30-50mA

Crank power: 300-350mA

Battery: Built-in 104050 rechargeable battery

AC power input interface: Micro USB