

1. About Your X10 Pro Omni

1.1 What's in the box

1.2 Overview

1.3 Buttons Control

1.4 LED Indication

2. Preparing Your X10 Pro Omni

2.1 Important Tips Before Use

2.2 Install the Omni Station

2.3 Charge Your RoboVac

2.4 Auto Recharge and Resume with the Omni Station

3. Using Your X10 Pro Omni with the eufy Clean App

3.1 Download the App

3.2 Reset the Wi-Fi Connection

3.3 Set Up No-Go Zone and No-Mop Zone

3.4 Schedule Cleaning

3.5 Select a Cleaning Mode

3.6 Selecting a Suction Power Level

4. Using the Mopping System

5. Using RoboVac with Amazon Alexa / The Google Assistant

6. Enabling / Disabling Child Safety Lock

7. Cleaning and Maintenance

7.1 Clean the Dust Box and Filter

7.2 Clean the Rolling Brush

7.3 Clean the Side Brush

7.4 Clean the Sensors, Cameras, and Charging Pins

7.5 Clean the Dirty Water Tank

7.6 Clean the Detachable Mopping Pads Cleaning Tray

8. Troubleshooting

9. Specifications

10. Warranty

1. About Your X10 Pro Omni

1.1 What's in the box

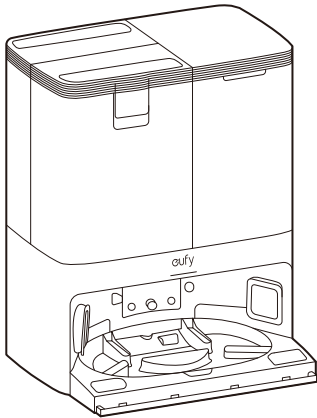

Omni Station

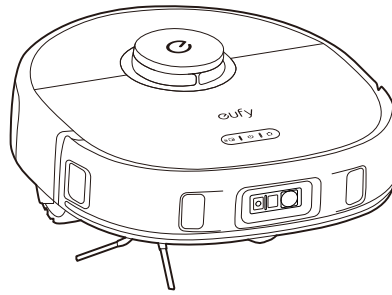

Robot

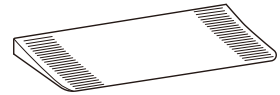

Detachable Base

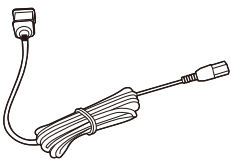

Power Cord

*The Power Cord varies by region.



Document

1.2 Overview

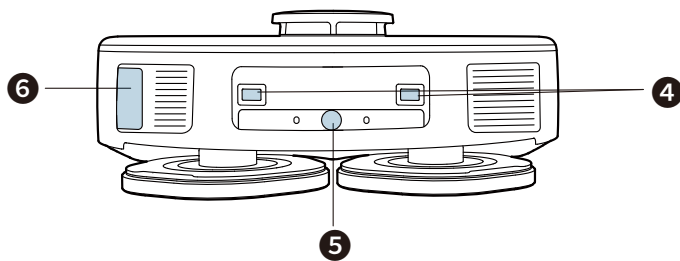
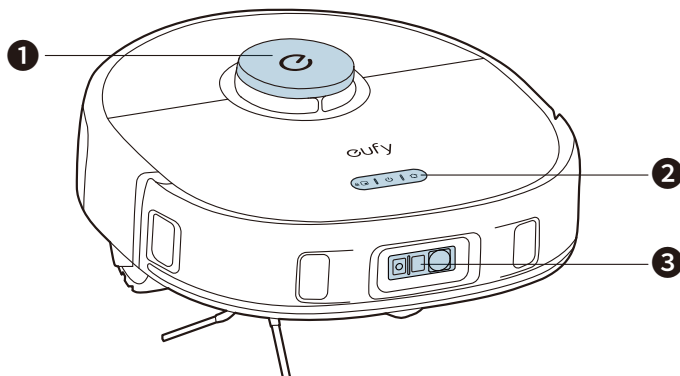

- ❶ Navigation Lidar
- ❷ Buttons
- ❸ RGB Camera+ LED Light
- ❹ Charging Contact Pins (x2)
- ❺ Water Injection Port
- ❻ Dust Collection Port

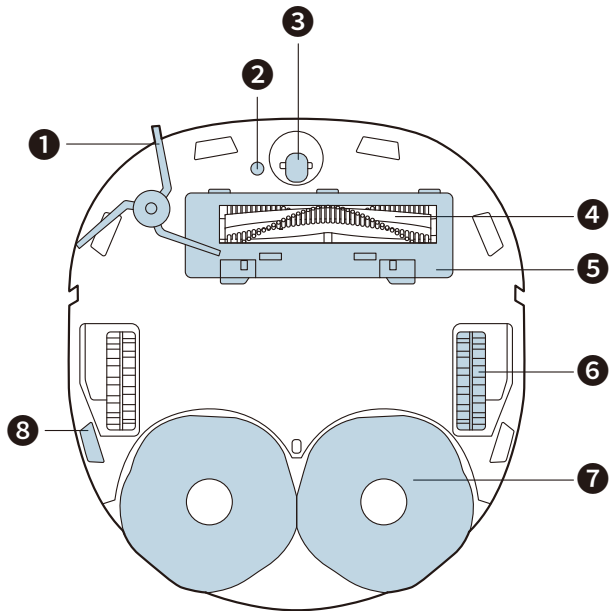

- ❶ Side Brush
- ❷ Carpet Detection Sensor
- ❸ Swivel Wheel
- ❹ Anti Detangling Rolling Brush
- ❺ Brush Guard
- ❻ Wheels (×2)
- ❼ Detachable Mopping Pads (×2)
- ❽ Drop Sensors (×6)

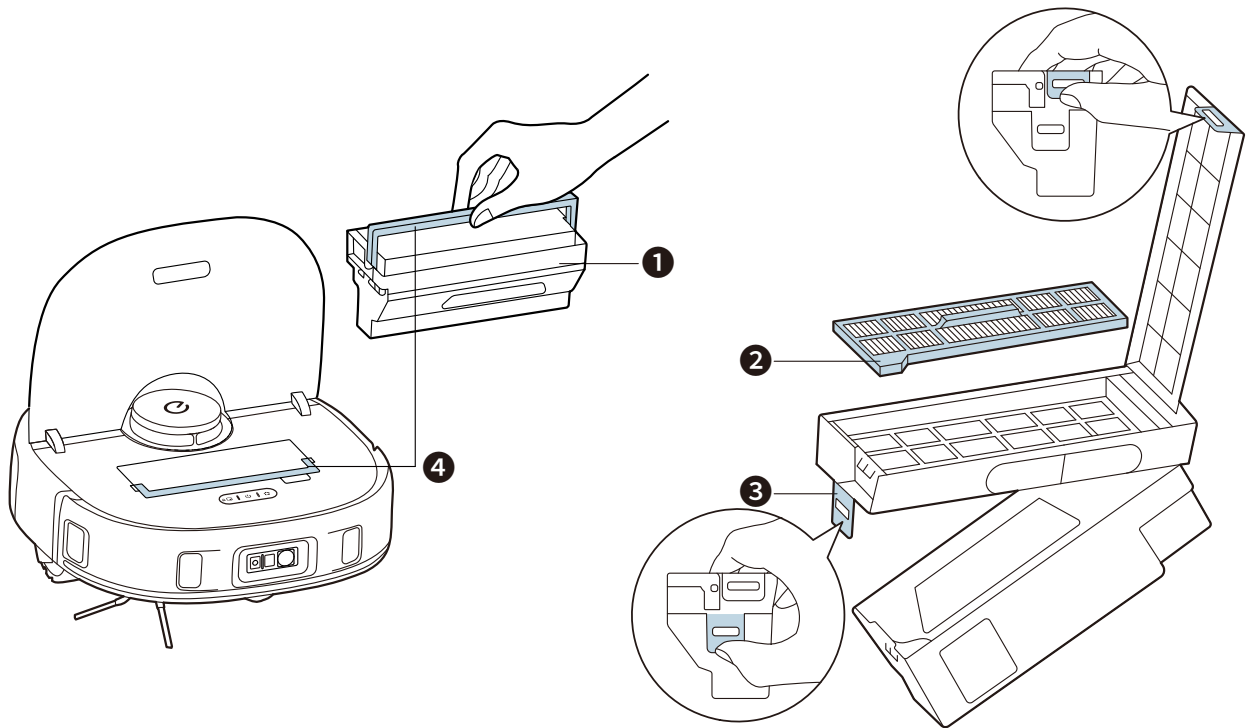

- ❶ Dust Box
- ❷ Filter
- ❸ Release Latch
- ❹ Handle

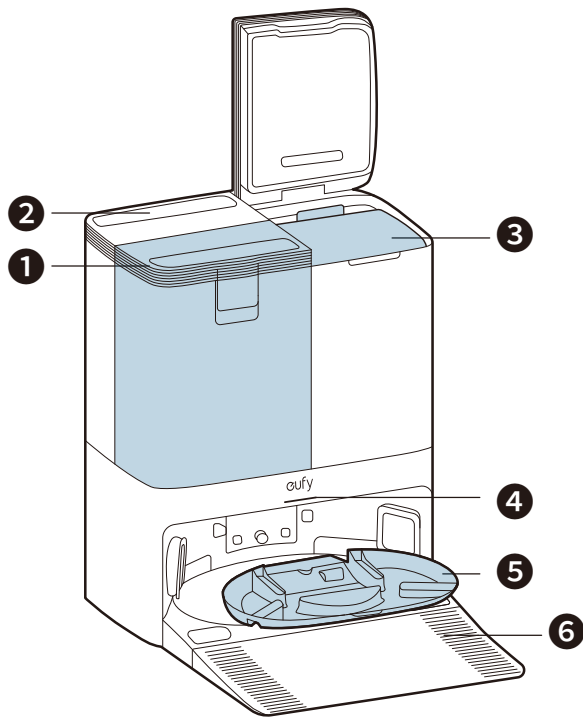

- ❶ Clean Water Tank
- ❷ Dirty Water Tank
- ❸ Disposable Dust Bag
- ❹ LED Indicator
- ❺ Detachable Mopping Pads Cleaning Tray
- ❻ Detachable Base

1.3 Buttons Control

	<ul style="list-style-type: none"> • Long press (3s): Power on or off • Short press: Pause / resume the current task when working
	<ul style="list-style-type: none"> • Short press: Return RoboVac to the Omni Station
	<ul style="list-style-type: none"> • Short press: Start spot cleaning • Long press (5s): Enable or disable Child Safety Lock
	<ul style="list-style-type: none"> • Long press simultaneously (3s): Reset the Wi-Fi connection

1.4 LED Indication

LED Indicators	LED Indication	RoboVac Status
	Pulsing white	Turned on
	Steady white	Standby / pause
	Steady white	Working normally
	Steady white	Working in spot cleaning mode
	Steady white	Returning to Omni Station
	Pulsing white	Charging
	Flashing red quickly	Error (Please refer to in-app instructions for solutions)

2. Preparing Your X10 Pro Omni

2.1 Important Tips Before Use

<p>A</p>	<p>A. Remove power cords and small objects from the floor that may entangle RoboVac.</p>
<p>B</p>	<p>B. Fold tasseled edges of rugs underneath to prevent tangling RoboVac. Avoid cleaning high-pile rugs or rugs thicker than 0.71 in / 18 mm as they may cause RoboVac to malfunction.</p>
<p>C</p>	<p>C. It is strongly recommended to place physical barriers or set a "No-Go" zone via the eufy Clean app in front of fireplaces and certain areas (i.e. air vents) that may cause damage to RoboVac if entered.</p>

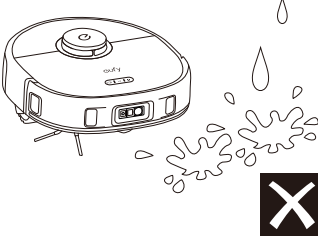
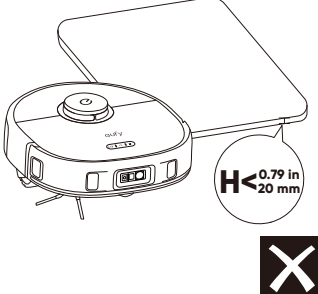
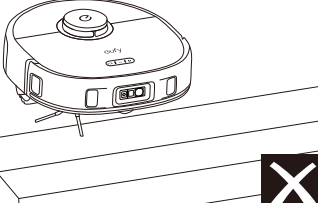
<p>D</p> 	<p>D. Avoid vacuuming large amounts of water as it will potentially damage the device.</p>
<p>E</p> 	<p>E. RoboVac may climb on top of objects less than 0.79 in / 20 mm in height. Remove these objects if possible.</p>
<p>F</p> 	<p>F. Anti-drop sensors will prevent RoboVac from tumbling down stairs and steep drops in most cases. Sensors are less effective if dirty or used on carpeted / reflective floors. Place physical barriers or set a "No-Go" zone to block off areas where RoboVac may fall.</p>

2.2 Install the Omni Station

1. Install the detachable base by pressing down both sides of it firmly.

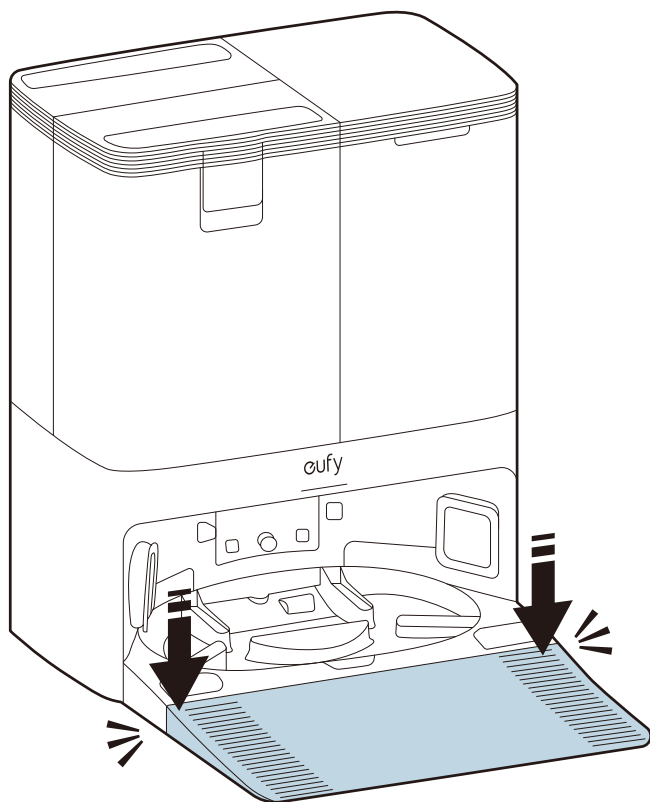

- 💡 • Make sure the detachable base is seamlessly connected to the Omni Station, otherwise RoboVac will fail to return to the Omni Station smoothly.

2. Place the Omni Station in a location that has strong Wi-Fi signal and RoboVac can easily access. It is recommended to place it against a wall and on a hard, level surface.

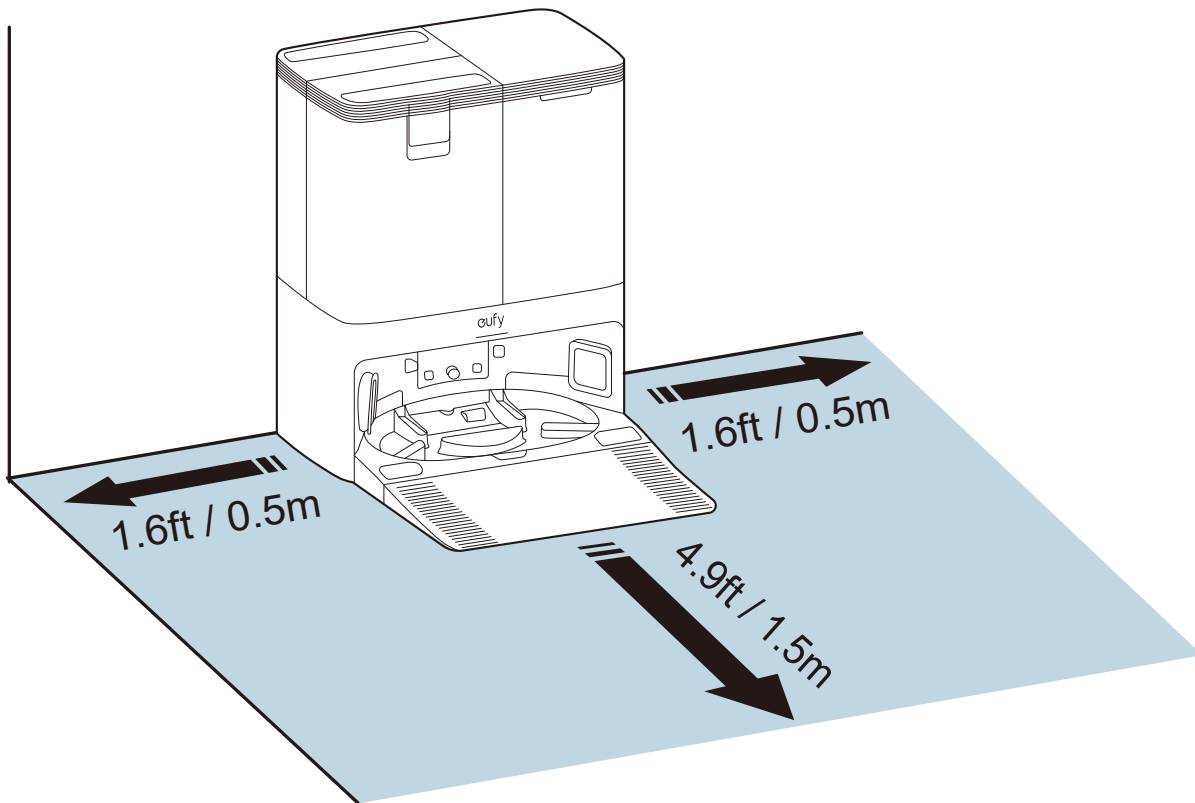

3. Connect the power cord to the Omni Station and a wall outlet.

-When the Omni Station connects to AC power, the LED indicator on the Omni Station is steady white.

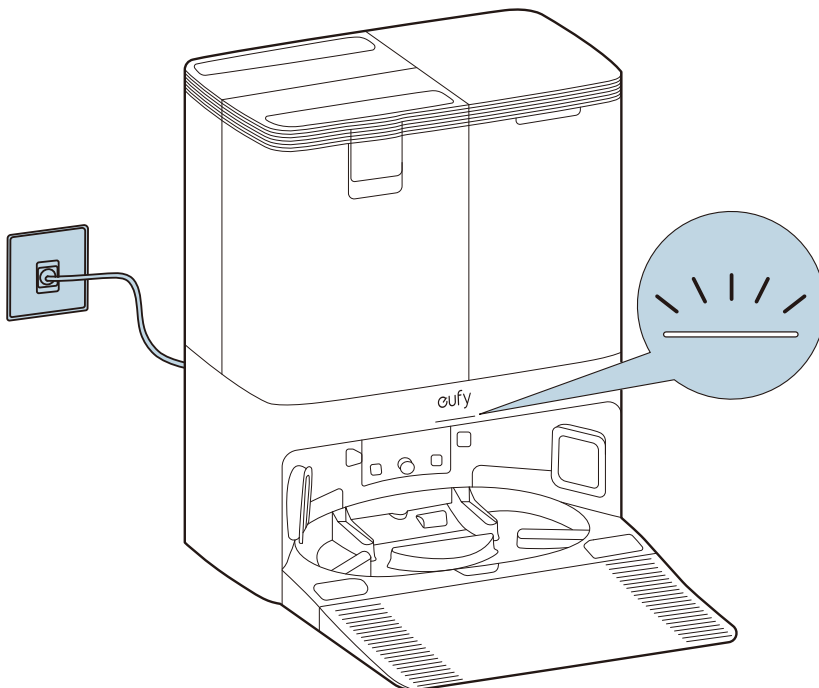

💡 • Always keep the Omni Station plugged in to ensure the infrared connection between RoboVac and the Omni Station is successful, otherwise RoboVac will not automatically return to it.

4. Take out the clean water tank. Add clean water until it reaches the MAX water line.

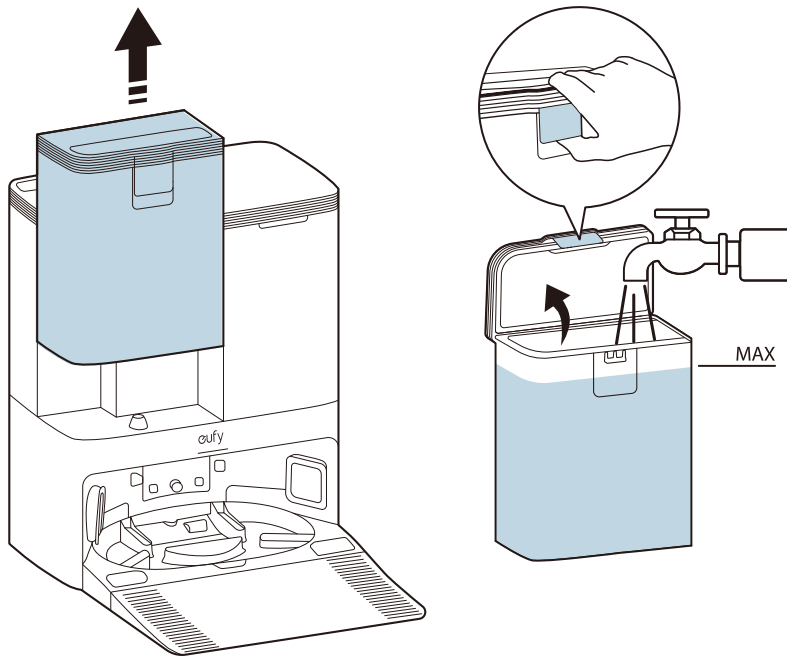

- Please do not add hot water into the tank to avoid shortening its service life.
- Only use the cleaning solution designated by eufy, otherwise it may affect the cleaning effect and damage the device.

2.3 Charge Your RoboVac

1. Remove the foam blocks and camera protection sticker before use.

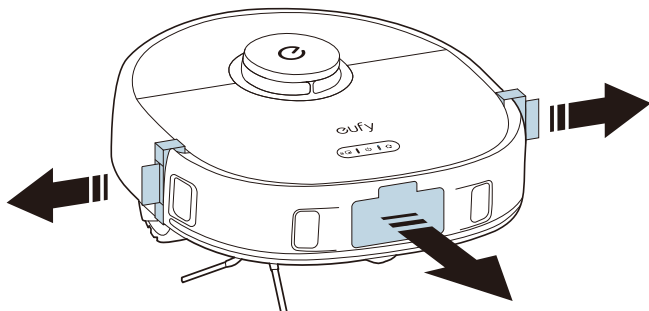

2. Attach RoboVac to the Omni Station. RoboVac will turn on and start charging automatically.

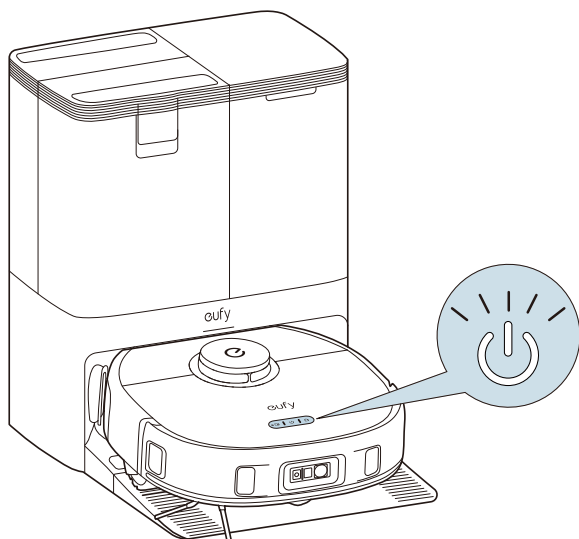

- The mopping pads will be automatically cleaned and dried when RoboVac returns to the Omni Station.

2.4 Auto Recharge and Resume with the Omni Station

RoboVac returns to the Omni Station automatically to recharge when:

- RoboVac has finished cleaning;
- Cleaning is not complete and the battery level becomes low; once recharged to the sufficient battery level for completing the cleaning task, RoboVac will resume and finish the remaining cleaning.

 • Do not move the Omni Station during cleaning. Do not unplug the Omni Station, otherwise RoboVac may fail to return for recharge.

3. Using Your X10 Pro Omni with the eufy Clean App

To enjoy all the available features, it is recommended to control your RoboVac via the eufy Clean app.

Before you start, make sure:

- Your smartphone is running iOS 11.0 (or above) or Android 8.0 (or above).
- The 2.4GHz band wireless signal is enabled on your wireless router.

3.1 Download the App

1. Download the eufy Clean app from the App Store (iOS devices) or Google Play (Android devices), or by clicking this link: (<https://dl-eufy.eufylife.com/qcdl/index.html?flow=eufy>).
2. Open the app and create a user account.
3. Tap the "+" icon to add RoboVac to your eufy Clean account.
4. Follow the instructions in the app to set up the Wi-Fi connection.
 - After connecting successfully, you can control RoboVac via the app.
 - With the app, you can select cleaning modes, select cleaning at your desired suction power, schedule cleaning, view the system status, set up "No-Go" zones, receive notifications, and access additional features.

 • If RoboVac gets stuck in any space, tap **Find My Robot** in the app to find the device.

3.2 Reset the Wi-Fi Connection

If you bump into issues when connecting your RoboVac to the eufy Clean app, you can try to reset the Wi-Fi connection.

Press and hold the home and spot cleaning buttons simultaneously for 3 seconds until you hear a voice prompt.

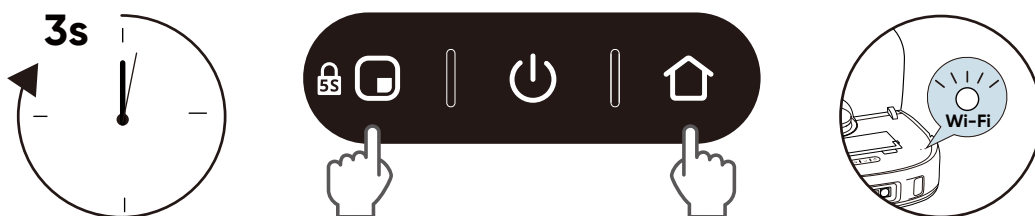

You will hear a voice prompt when the Wi-Fi connection has been reset, and the LED indicators on RoboVac will quickly flash blue. Now you can follow the instructions in the app to set up the Wi-Fi connection.

3.3 Set Up No-Go Zone and No-Mop Zone

With the eufy Clean app, you can set up a “No-Go Zone” or “No-Mop Zone” as a restricted area. This eliminates the need to use physical barriers, including boundary strips. This feature is only designed for dividing the cleaning zones, not for isolating hazardous areas.

- No-Go Zone: RoboVac will not enter the zone to vacuum.
- No-Mop Zone: RoboVac will not enter the zone to mop.

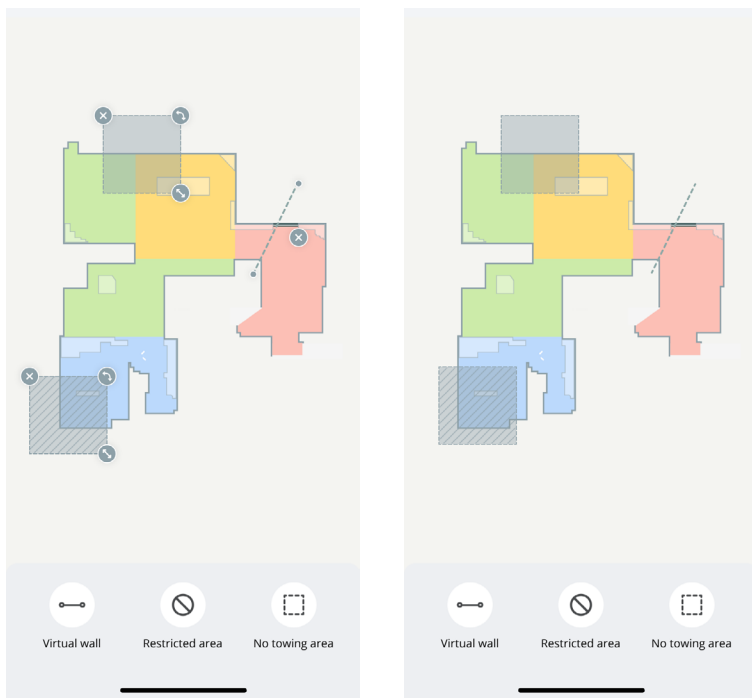

3.4 Schedule Cleaning

With the eufy Clean app, you can schedule RoboVac to start cleaning at a particular time.

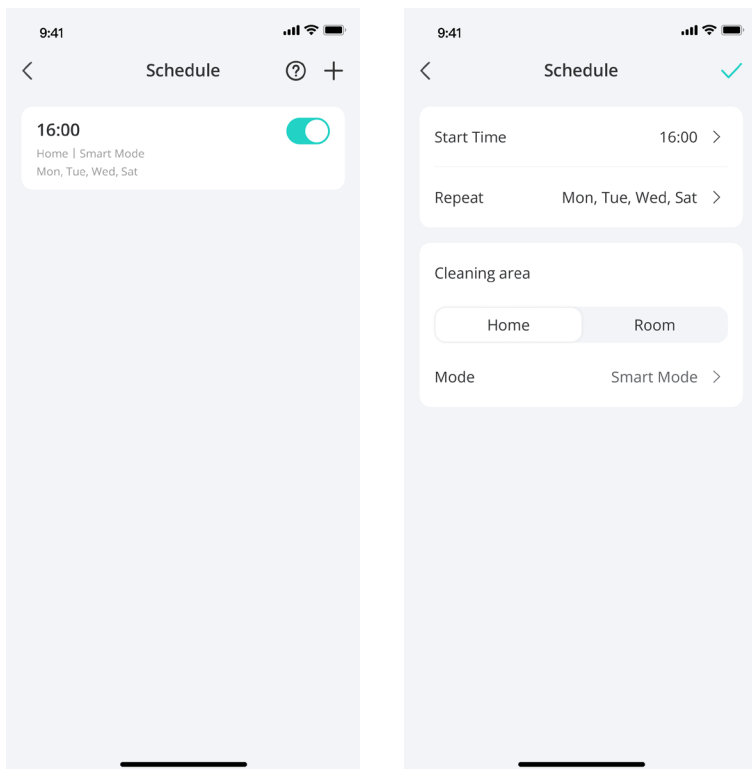

- You can set the time and customize cleaning schedules from Sunday to Saturday on the eufy Clean app. This function is only available on the app.

3.5 Select a Cleaning Mode

You can start / pause cleaning or select a cleaning mode via the eufy Clean app.

3.5.1 Home Cleaning Mode

Tap Start in the eufy Clean app to enable Home Cleaning mode.

After startup, RoboVac moves from the Omni Station and automatically determines its cleaning route, cleaning the edges first and following a Z-shaped cleaning path. When cleaning is finished, RoboVac automatically returns to the Omni Station.

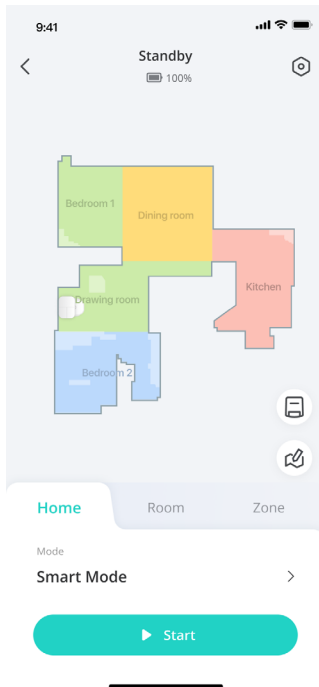

- To pause cleaning, tap Pause in the app or press the power button on RoboVac.

3.5.2 Room Cleaning

In this mode, your house is automatically divided into several rooms for cleaning in the eufy Clean app. You can also customize your room settings in the app. RoboVac will clean the selected rooms only and return to the Omni Station after cleaning.

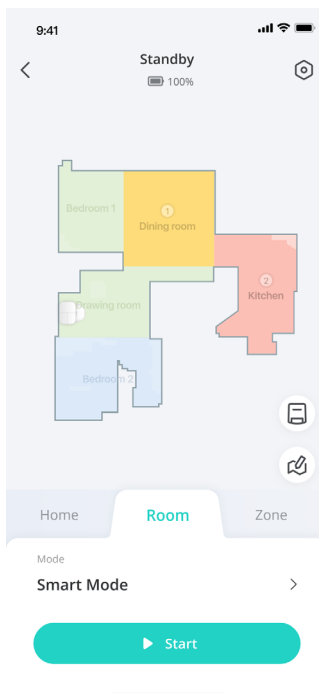

-  Enable Room Cleaning only after RoboVac has created the map.
- It is recommended that RoboVac moves from the Omni Station to start room cleaning.

3.5.3 Zone Cleaning

In this mode, you can set up a cleaning zone and customize its size in the eufy Clean app, RoboVac will clean the selected zone only.

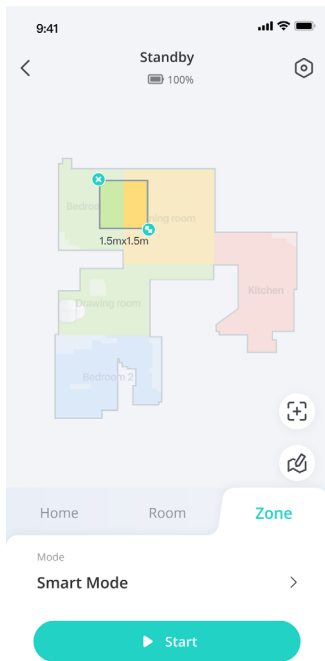

3.5.4 Spot Cleaning Mode

In this mode, RoboVac intensively cleans a specific area with a size of 4.9 ft x 4.9 ft / 1.5 m x 1.5 m, useful if there is a concentrated area of dust or debris. When the cleaning of a certain zone is finished, it automatically returns to the Omni Station.

- Press the spot cleaning button on RoboVac to start cleaning in Spot Cleaning mode.

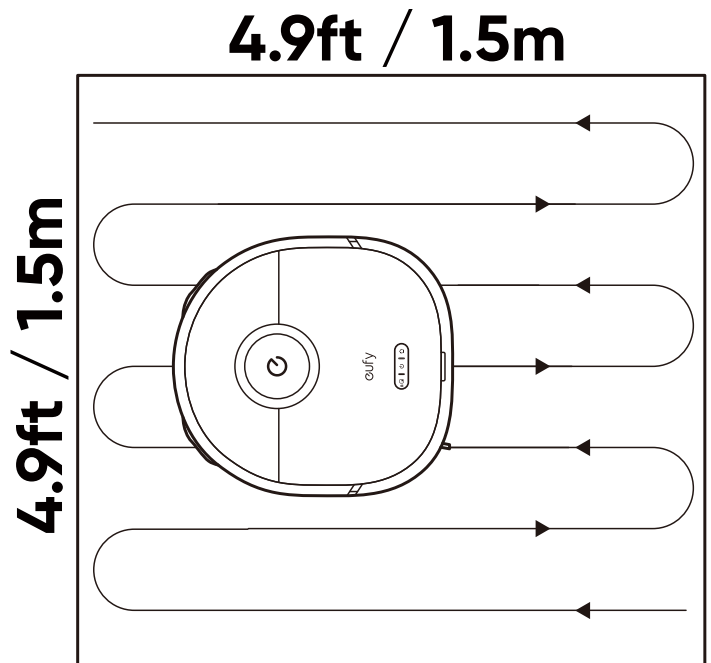
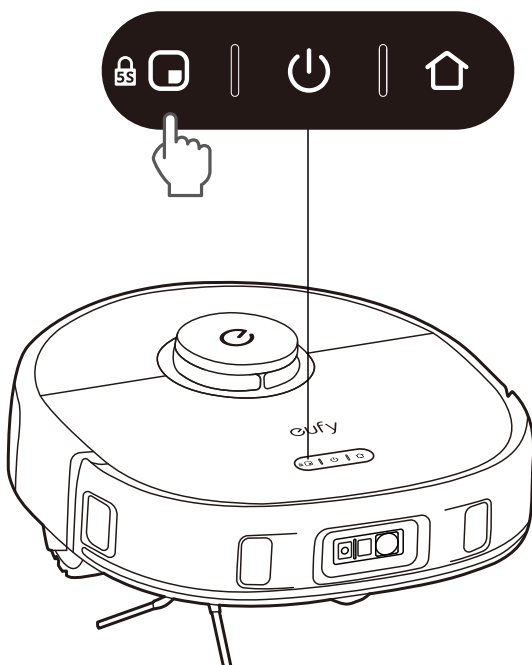

3.6 Selecting a Suction Power Level

In the eufy Clean app, select a suction power level according to your needs: Quiet, Standard (Default), Turbo, and Max.

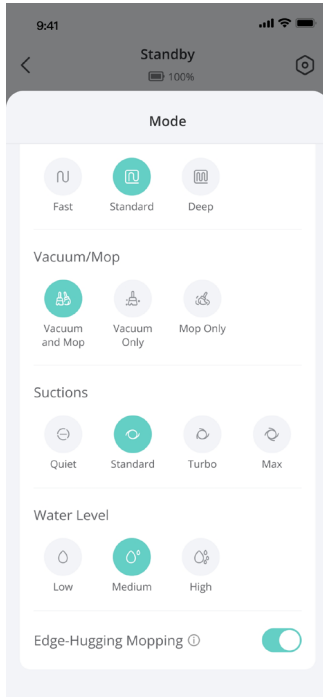

💡 • When RoboVac starts cleaning next time, it will clean according to the suction power level you previously selected.

In the eufy Clean app, you can also select the BoostIQ™ feature according to your needs. RoboVac will automatically increase suction power if it detects that stronger power is needed to ensure the best clean. BoostIQ™ is ideal for cleaning thicker carpets and hard-to-sweep messes, which will reduce the total cleaning time but increase the noise level. If the vacuuming noise caused by BoostIQ™ disturbs you, you can disable this feature.

4. Using the Mopping System

1. Start cleaning. RoboVac will automatically vacuum and mop. During mopping, you can choose among three water levels via the eufy Clean app.

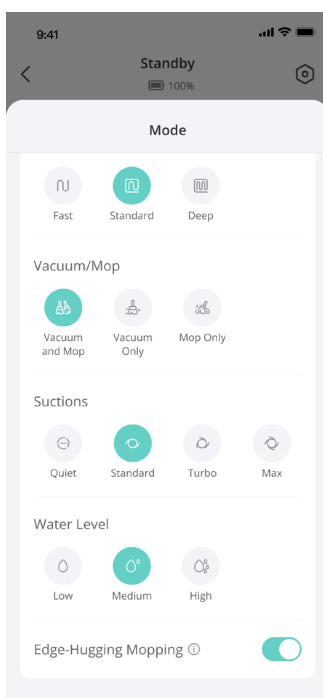

2. When RoboVac finishes cleaning, clean the dirty water tank to prevent mildew or unpleasant smells. For instructions on how to clean the dirty water tank, refer to the **"Cleaning and Maintenance"** section in this manual.

5. Using RoboVac with Amazon Alexa / The Google Assistant

Amazon Alexa or the Google Assistant are smart voice control devices that enable you to control RoboVac with your voice.

Before you start, make sure:

- RoboVac is attached to the Omni Station to ensure there is enough power.
- RoboVac is connected with the eufy Clean app.
- You have an Amazon Alexa-enabled device (i.e. Amazon Echo, Echo Dot, Amazon Tap, Echo Show, or Echo Spot) or a device enabled with the Google Assistant (i.e. Google Home, Google Home Mini). These devices are sold separately.
- The Amazon Alexa app or Google Home app is already installed on your smart device, and you have created an account.

To control RoboVac with Amazon Alexa or the Google Assistant:

1. Open the eufy Clean app and find "Smart Integrations" in the top left.
2. Follow the on-screen instructions to complete the setup.

6. Enabling / Disabling Child Safety Lock

- Press and hold the spot cleaning button for 5 seconds to activate the child safety lock. Once the child safety lock is enabled, all buttons will be locked to prevent children from damaging the device or accidentally getting hurt.

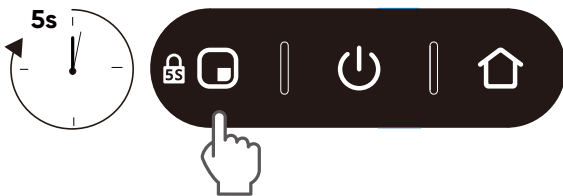

- To disable the child safety lock, press and hold the spot cleaning button for 5 seconds again.

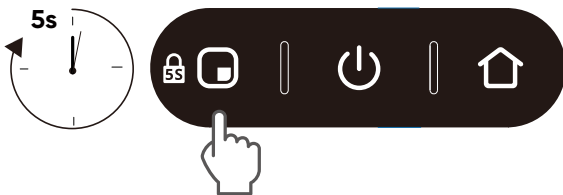

 • This function is also available in the eufy Clean app.

7. Cleaning and Maintenance

Prior to cleaning and maintaining, power off the device and unplug the power adapter. Any other servicing should be performed by an authorized service representative.

For optimal performance, follow the instructions below to clean and maintain regularly. The cleaning and replacement frequency will depend on your usage habits.

Recommended Cleaning and Replacement Frequency

 Click this link to shop for accessories: <https://us.eufy.com/collections/x10-pro-omni-accessories>

RoboVac Part	Cleaning Frequency	Replacement Frequency
Dust Box	Once a week	-
Dirty Water Tank	Empty and clean when full	
Mopping Pads	-	Every 3-6 months
Filter	Once a week	Every 3-6 months
Side Brush	Once a month	Every 3-6 months (or when visibly worn)
Brush Guard	Once a month	Every 3-6 months (or when visibly worn)
Rolling Brush	Once a month	Every 6 months
Sensors	Once a month	-
Charging Pins	Once a month	-
Swivel Wheel	Once a month	-

7.1 Clean the Dust Box and Filter

- ① Open the top cover and take out the dust box.
- ② Press the release button to open and empty the dust box.
- ③ Remove the filter.
- ④ Tap the filter to remove dust.
- ⑤ Rinse the dust box and filter thoroughly with water.
- ⑥ Air dry the dust box and filter completely before next use.
- ⑦ Place the filter back into the dust box.
- ⑧ Push the dust box back into the main unit.

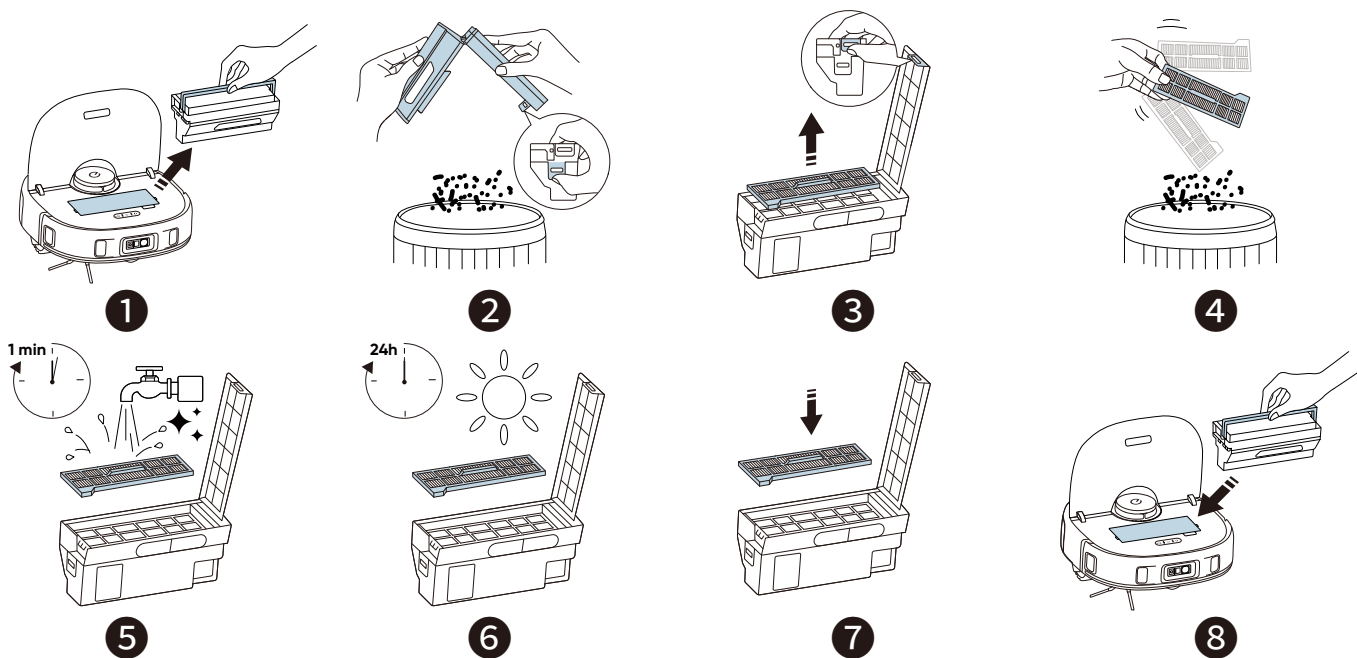

- Do not use a brush, hot water, or any detergent to clean the filter.
- Do not use the filter if it is not completely dry, otherwise it may affect the cleaning performance.

7.2 Clean the Rolling Brush

- ① Pull on the release tabs to unlock the brush guard, as shown.
- ② Lift to take out the rolling brush. Clean the rolling brush with scissors.
- ③ Rinse the rolling brush and brush guard with running water.
- ④ Air dry the rolling brush and brush guard completely before next use.
- ⑤ Reinstall the rolling brush by inserting the fixed protruding end first.
- ⑥ Press down to snap the brush guard into place.

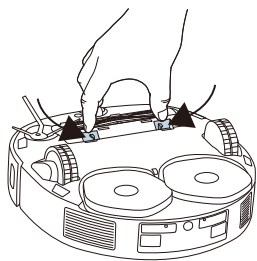

1

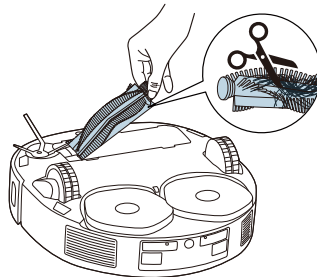

2

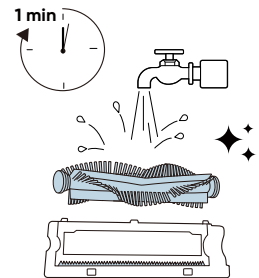

3

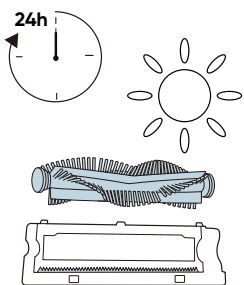

4

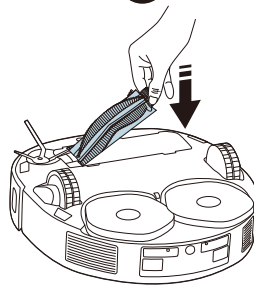

5

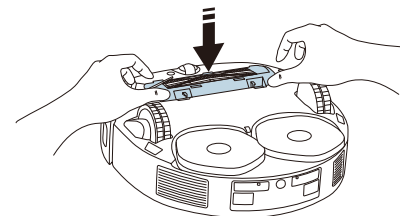

6

7.3 Clean the Side Brush

Foreign substances, such as hair, can easily get tangled in the side brush, so it is best to clean it regularly.

- ① Remove the side brush with a screwdriver.
- ② Carefully unwind and pull off any hair or substances that are wrapped between the main unit and the side brush.
- ③ Clean the side brush with water.
- ④ Air dry the side brush before next use.
- ⑤ Reinstall the side brush on the machine.

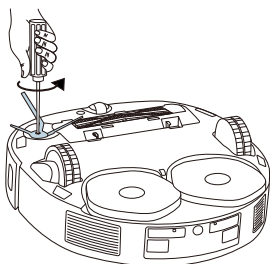

1

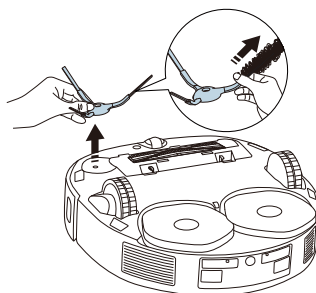

2

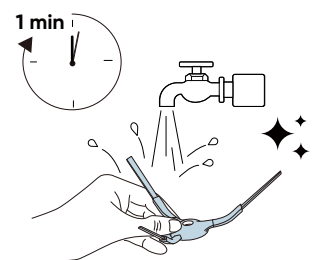

3

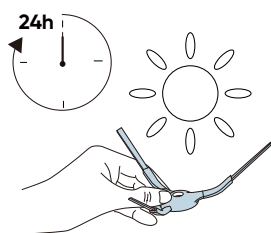

4

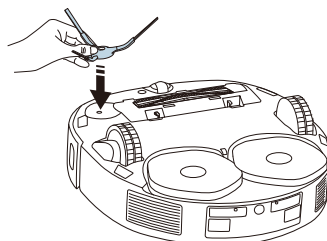

5

7.4 Clean the Sensors, Cameras, and Charging Pins

To maintain the best performance, clean the sensors and charging contact pins regularly.

- Dust off the sensors and charging contact pins using a soft cloth.

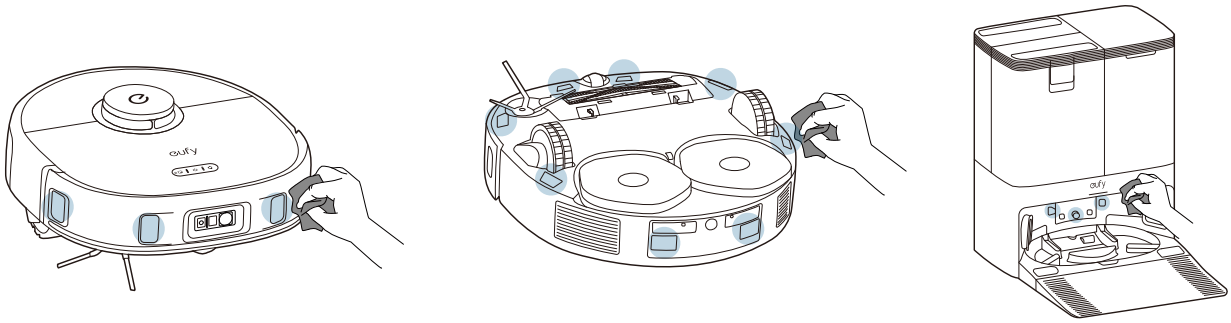

7.5 Clean the Dirty Water Tank

- ① Remove the dirty water tank from the Omni Station.
- ② Empty the dirty water tank.
- ③ Rinse the dirty water tank thoroughly with running water.

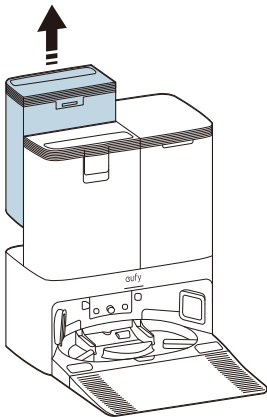

1

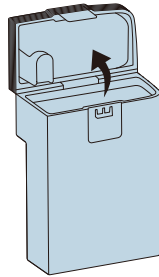

2

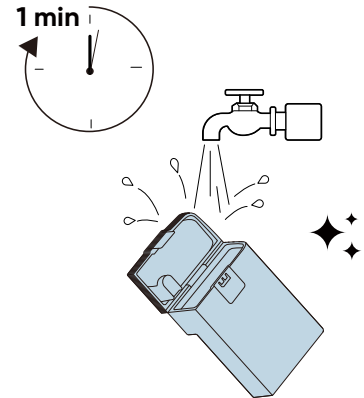

3

7.6 Clean the Detachable Mopping Pads Cleaning Tray

- ① Remove the cleaning tray from the Omni Station.
- ② Rinse the cleaning tray thoroughly with water.
- ③ Place the tray back into the Omni Station.

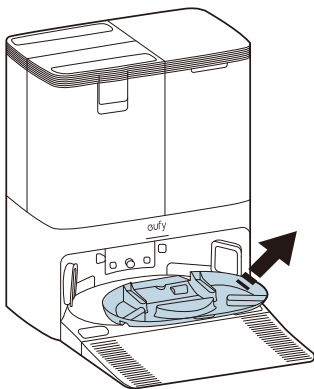

1

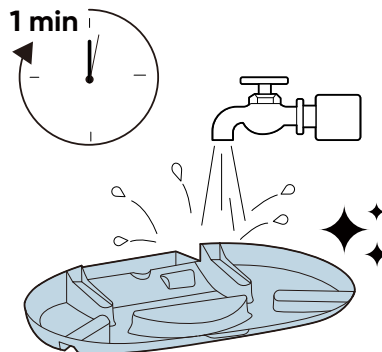

2

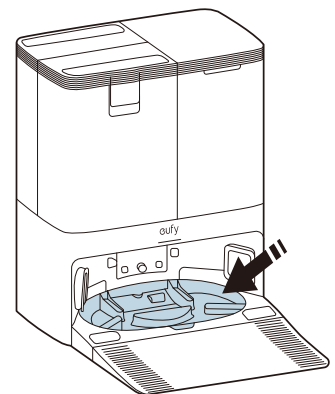

3

8. Troubleshooting

When an error occurs, please refer to the in-app instructions for solutions.

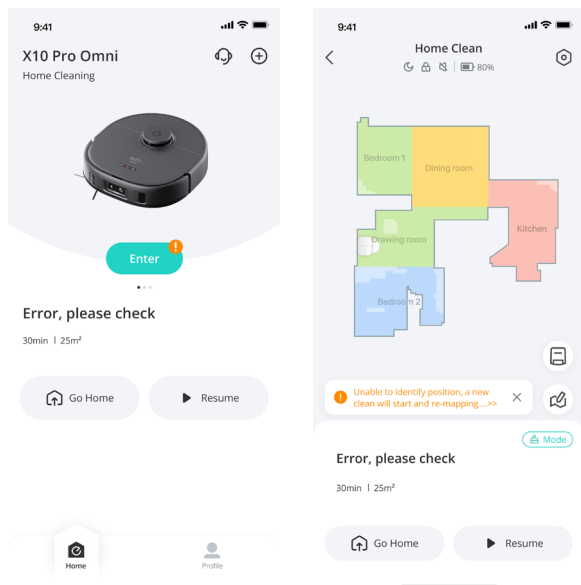

You can also click the link below to view our FAQs for a quick fix. If the problem persists, please contact support@eufy.com for help.

FAQs: <https://support.eufy.com/s/product/a085g00000BdaluAAB/eufy-clean-x10-pro-omni>

9. Specifications

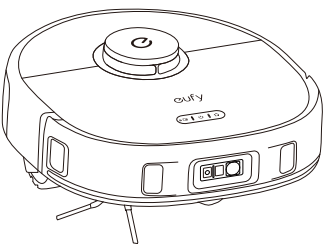
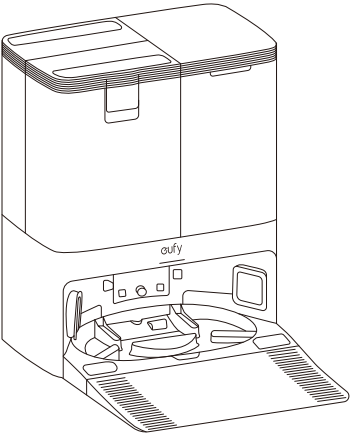
	Power Consumption	60W
	Battery	2600mAh x 2
	Input	US: 100-127V, 50-60Hz EU: 220-240V, 50-60Hz
	Output	US: 20V / 1.2A EU: 20V / 1.2A
	Clean Water Tank Capacity	3L
	Dirty Water Tank Capacity	2.7L
	Dust Bag Capacity	2.5L

10. Warranty

The product's warranty period is determined by the seller and may vary according to different sales channels and local legal requirements, but the minimum warranty period shall not be less than 12 months.

Note: The 12-month warranty covers the main unit (including the battery) and the Omni Station, not applicable to consumables like rolling brush, side brush, mopping pads, etc.

This limited warranty provided by the manufacturer does in no way affect a potential statutory warranty provided by law.