



# Operating instructions

## OT860 IS



# Electric oven

---

## ***Dear customer!***



We sincerely thank you for your purchase. We believe you will soon find ample evidence that you can really rely on our products. To make the use of the appliance easier, we attach these comprehensive instruction manual.

The instructions should aid you in getting familiar with your new appliance. Please, read them carefully before using the appliance for the first time.

In any case, please make sure the appliance was supplied to you undamaged. Should you identify and transport damage, contact your sales representative or the regional warehouse from where the product was delivered. You will find the telephone number on the receipt or delivery report. We wish you a lot of pleasure with your new household appliance.

---

## ***Instructions for connection***

The connection should be carried out in compliance with the instructions in the section “Connection to the power mains”, and the relevant effective regulations and standards. This should only be performed by a qualified technician.

---

## ***Rating plate***

The rating plate indicating the basic information on the appliance is attached to the edge of the oven and it is visible when you open the oven door.

<b>Important - Read before using the appliance .....</b>	<b>4</b>
<b>Appliance description .....</b>	<b>6</b>
<b>The oven.....</b>	<b>7</b>
<b>Food preparation.....</b>	<b>20</b>
<b>Cleaning and maintenance .....</b>	<b>31</b>
<b>Special warnings and error reporting.....</b>	<b>37</b>
<b>Instructions for installation and connection.....</b>	<b>38</b>
<b>Technical characteristics.....</b>	<b>41</b>

418671

## Important - Read before using the appliance

### *Safety precautions*

- This appliance can be used by children aged from 8 years and above and persons with reduced physical, sensory or mental capabilities or lack of experience and knowledge if they have been given supervision or instruction concerning use of the appliance in a safe way and understand the hazards involved. Children shall not play with the appliance. Cleaning and user maintenance shall not be made by children without supervision.
- **WARNING:** The appliance and its accessible parts become hot during use. Care should be taken to avoid touching heating elements. Children less than 8 years of age shall be kept away unless continuously supervised.
- Only use the temperature probe recommended for this oven.
- **WARNING:** Ensure that the appliance is switched off before replacing lamp to avoid the possibility of electric shock.
- Do not use harsh abrasive cleaners or sharp metal scrapers to clean the oven door glass since they can scratch the surface, which may result in shattering of the glass.
- Do not use steam cleaners or high-pressure cleaners to clean the cooking hob, as this may result in an electric shock.
- Before activating automatic cleaning with pyrolysis, wipe any spilt liquid from the oven and remove the grid, the grease filter, the spit roasting kit, glass baking strays, meat probe, and any other cookware that is not a part of the oven equipment.
- During automatic cleaning process with pyrolysis, the oven will become very hot on the outside as well; therefore, keep the children away from the oven during this time. Risk of burning.
- The appliance is not intended to be controlled by external timers or special control systems.

### *Warnings*

- The appliance may only be connected to the power mains by an authorized service technician or expert.
- Tampering with the appliance or non-professional repair thereof may result in risk of severe injury or damage to the product. Any repairs may only be carried out by an authorized service technician or expert.

- If the power cords of appliances located near this appliance are caught in the oven door, they can be damaged, which may in turn result in a short circuit. Therefore, keep the power cords of other appliances at a safe distance.
- The appliance is intended solely for cooking. Do not use it for any other purpose, e.g. for room heating. Do not place empty cookware on the cooking zones.
- Be particularly careful when cooking food in the oven. Due to high temperatures, baking trays, baking sheets, the grid and the oven interior walls become very hot. Always use oven mitts.
- Do not line the oven walls with aluminium foil and do not place baking trays or other cookware on the oven bottom. Aluminium foil would prevent air circulation in the oven, hinder the cooking process, and ruin the enamel coating.
- Oven door become very hot during operation. A third glass is installed or additional protection to reduce the temperature of the outside surface (only with some models).
- Oven door hinges may be damaged if overloaded. Do not place heavy cookware on the open oven door and do not lean against the door while cleaning the oven. Before cleaning the oven, remove the oven door (see chapter »Removing and re-installing the oven door«). Do not stand or sit on the open oven door (children!).
- Before activating automatic cleaning with the pyrolysis procedure, carefully read and follow the instructions in the chapter Cleaning and maintenance where correct and safe use of this function is described.
- Never hang combustible (ignitable) objects on the oven handle (e.g. dish cloths). Danger of fire!
- The gasket on the oven door is not removable. The manufacturer shall not be responsible for any damage resulting from an attempt to remove it.
- Make sure no impurities enter the door guide lock opening, which could prevent automatic locking of oven door during the pyrolytic cleaning procedure.
- Do not place anything directly onto the oven cavity bottom.
- Pieces of food, grease, and roast juice can ignite during the automatic pyrolytic cleaning process.
- Always insert the metal protective cap of the meat probe socket (only with some models) before using the oven. Otherwise, the oven will not heat up.
- As a result of the pyrolytic cleaning, the oven cavity and oven equipment cleaned in such way may discolour and loose its shine.
- Breaking of the inner door glass will result in large sharp pieces of glass. Danger of cuts!



**The symbol on the product or on its packaging indicates that this product may not be treated as household waste. Instead it shall be handed over to the applicable collection point for the recycling of electrical and electronic equipment. By ensuring this product is disposed of correctly, you will help prevent potential negative consequences for the environment and human health, which could otherwise be caused by inappropriate waste handling of this product. For more detailed information about recycling of this product, please contact your local city office, your household waste disposal service or the shop where you purchased the product.**

## **Appliance purpose**

The appliance is intended for conventional preparation of food in households and should not be used for any other purpose. Individual options of use are comprehensively described in this instruction manual.

## Appliance description

The figure represents one of the appliance models. Since a group of appliances to which these instructions apply, have different features, the instruction manual may describe functions and equipment that may not be available in your appliance.



1. Control panel
2. Oven door handle
3. Oven door



- 1 On/Off knob and oven operation mode selection knob
- 2 Electronic program digital timer with temperature and operation mode display
- 3 Temperature selection knob / dial

---

**Oven door switch**

The switch will turn off the oven heating and the fan when door is opened during oven operation; when the door is closed again, the heating is resumed.

---

**Cooling fan**

The appliance features a built-in cooling fan which cools the appliance housing and control panel.

---

**Extended operation of the cooling fan**

After the oven is switched off, the cooling fan continues to operate for a while in order to additionally cool down the appliance.

---

**Control lamps****Yellow lamp**

The lamp is lit when any of the appliance functions are activated.

**Backlit knob dials**

(only with some models)

The dial of an activated knob is lit when a function is selected.

Appliances with this feature do not have the yellow control lamp.

---

## The oven

---

**Before using the oven for the first time**

- Remove all accessories from the oven and clean them with warm water and a conventional detergent. Do not use abrasive cleaning aids.
- When the oven is heated up for the first time, a specific odor of a "new appliance" will be discharged; therefore, ventilate the room thoroughly while the oven heats up.

---

**Important warnings**

- Use dark, black silicon coated or enamel coated baking trays, as these transmit the heat particularly well.
- Only preheat the oven if specifically stated in the recipe or in the instruction tables herein.
- Heating up an empty oven uses a lot of energy; therefore, a lot of power is saved if several types of pastry are cooked consecutively, as the oven is already heated up.
- Approximately ten minutes before the anticipated end of the cooking process, the oven may be turned off. This way, you will save some power and make use of the accumulated heat.
- Note: When cooking is completed, the cooling fan will stop operating. If you leave the dish in the oven, steam could evaporate from it and condense on the front panel and the oven door. In order to prevent condensation, set the program selector switch to the »light« position. Thus, the cooling fan will continue to operate and cool the oven, preventing the accumulation of condensate.

**Electronic program  
digital timer with  
temperature and  
operation mode display**

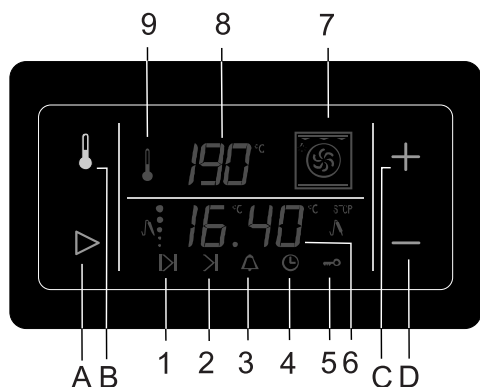

**Sensor keys:**

- A** Settings selection and confirmation sensor key
- B** Temperature setting sensor key
- C** Value increase (plus) sensor key
- D** Value decrease (minus) sensor key

**Display:**

- 1** Oven operation duration
- 2** Oven operation stop time
- 3** Countdown alarm timer
- 4** Time of day
- 5** Child lock
- 6** Clock – time display / meat probe temperature display
- 7** Operation mode display
- 8** Temperature display
- 9** Heater operation symbol

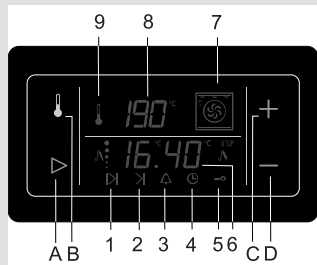

- When the appliance is connected to the power supply or after a power failure, the word “META” or “GLAS” is first displayed for a short while; then, the display flashes for some time. In order to enable the operation of the oven, use the (C) and (D) sensor keys to set the time of day.
- Each press / activation of a sensor key is acknowledged by a beep.
- Select the type of setting you wish to make by pressing the (A) sensor key. The selected symbol on the display flashes quickly, indicating the function that you can set or change. After five seconds, the symbol starts flashing more slowly and the time set is displayed. The symbols that are lit are selected, but not currently shown on the display (6). The most recent setting made is always displayed.
- If one of the value settings sensor keys (C) or (D) is touched and kept pressed, the rate at which the value being set is changing will increase.
- In case of a power failure which lasts less than two minutes, all settings remain active.

**⚠ To improve the response of the sensor keys, touch them with a larger surface of your finger.**

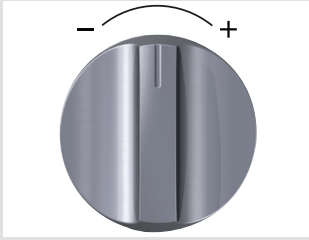

- Temperature and other settings may also be set using a special knob that replaces touching the program timer sensor keys.

### Setting the time of day (clock)

- Set the clock to the current time of day by pressing the settings selection sensor key (A). Then, select the symbol (4).
- Use the (C) and (D) sensor key to set the exact time of day.
- Confirm the setting by pressing the (A) sensor key again; if the (A) key is not pressed, the setting is automatically confirmed after a few seconds.

### Setting the timer functions

In addition to setting the temperature, the electronic program timer can also be used to set the timer functions. Both settings are indicated on the same display. Require display is set by pressing the relevant sensor key (A) or (B).

### The program timer can be used to program the oven operation in three ways:

- **Cooking time setting** - immediate start of oven operation; after a set period of time, the oven is turned off automatically.
- **Cooking end time setting** - the time at which oven operation is to end is set.
- **Delayed start setting** - automatic start and end of oven operation at a selected time.

### Setting the cooking time

With this program mode, the duration of oven operation is set (cooking time). Maximum setting allowed is 10 hours.

- Press the (A) sensor key to select the symbol (1). Use the (C) and (D) sensor keys to set the duration / cooking time.
- Turn on the oven (set the selector knob and cooking temperature). After the expiration of the set time, the oven will automatically stop operating (end of cooking time). An intermittent beep will sound, which can be stopped by pressing any key; if no key is pressed, the beep stops after one minute.
- The symbol (1) and the sign ( : \_ ) will flash. If you wish to resume cooking, press the (A) sensor key and set a new duration if necessary.

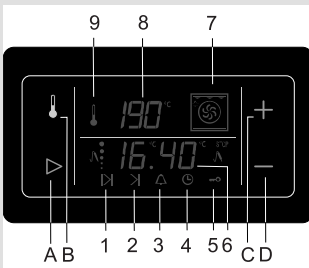

### Setting the cooking end time

This mode allows you to set the time at which the oven should stop operating. Maximum setting allowed is 10 hours relative to the current time of day.

- Make sure the current time of day is set correctly.
- Use the (A) sensor key and select the symbol (2). The current time of day is indicated on the display. Press the (C) and (D) sensor keys to set the cooking end time.
- Turn on the oven (set the selector knob and cooking temperature).

The oven starts to operate immediately and stops operation at the set time. An intermittent beep will sound, which can be stopped by pressing any key; if no key is pressed, the beep stops after one minute.

- The symbol (1) and the sign (:\_\_ ) will flash. If you wish to resume cooking, press the (A) sensor key and set a new duration if necessary.

### Setting the oven delayed start

With this operation mode, two settings have to be made: cooking time (duration of oven operation) and cooking end time (time at which the operation should stop).

Cooking end time can be delayed by a maximum of 24 hours relative to the current time of day.

- Make sure the current time of day is set correctly.
- First, set the cooking time: Press the (A) sensor key to select the symbol (1). Use the (C) and (D) sensor keys to set the duration / cooking time.
- Then, set the cooking end time: Use the (A) sensor key and select the symbol (2). (A sum of the current time of day and the oven operation time is automatically shown on the display). Press the (C) and (D) sensor keys to set the cooking end time.
- The timer will wait for the start of the cooking – both symbols (1 and 2) are lit.
- Turn on the oven (set the selector knob and cooking temperature). At the corresponding time, the oven starts operating automatically (the symbol (2) goes off upon the start of operation), and switches off when the set cooking time has elapsed. An intermittent beep will sound, which can be stopped by pressing any key; if no key is pressed, the beep stops after one minute.
- The symbol (1) and the sign (:\_\_ ) will flash. If you wish to resume cooking, press the (A) sensor key and set a new duration if necessary.

### Setting the alarm timer

The clock can also be used independently of the oven operation, as an alarm timer that sounds an alarm after the expiration of a preset time.

- Use the (A) sensor key to select the symbol (3). Then, use the (C) and (D) sensor keys to set the time before the alarm sounds. Maximum setting allowed is 10 hours.
- When the set time has elapsed, an intermittent beep will sound, which can be stopped by pressing any key; if no key is pressed, the beep stops after one minute. The symbol (3) will go off.



**The last minute of the timer countdown is displayed in second intervals.**



**For safety reasons, the oven will automatically go off after a certain period of time:**

- after 10 hours, if the cooking temperature is above 120°C;
- after 24 hours, if the temperature set is lower than 120°C.

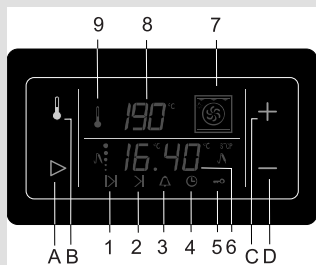

### Setting the beep volume (loudness)

The alarm volume can be set when no timer function is activated (only current time of day is displayed).

- Press the (D) sensor key and hold it approximately three seconds; a volume indicator will appear, and the corresponding sample sound will sound. "oooo" indicates maximum volume, and "o" indicates minimum volume. Use the (D) sensor key to select among the four loudness levels.
- Confirm the selected volume level by pressing the (A) sensor key; if the (A) sensor key is not pressed the setting will be confirmed and stored automatically after a few seconds.

### Setting the child lock

**Activation:** Press the (A) sensor key to select the symbol (5). Use the (B) and (C) sensor keys to activate the child lock; the display will read "ON". Confirm the setting by pressing the (A) sensor key.

**Deactivation:** Press the (C) or (D) sensor to deactivate the child lock; "OFF" is displayed.

The setting must be confirmed by pressing the (A) sensor key.

- If the timer is locked when no timer function is set (only the current time of day is displayed), the oven will not operate and no changes to any setting will be allowed.
- If the timer is locked after one of the timer functions has been set, the oven will operate as usually; however, no changes to the settings will be possible.

### Display dimmer

One minute after the appliance is turned off, the display will be dimmed.

### Deleting the timer settings

- All timer settings can be deleted any time by pressing the (C) and (D) sensor keys simultaneously and holding them for three seconds. The set programs are automatically interrupted and the timer switches to display of the current time of day.
- Any timer setting can also be deleted in the following way: selecting it using the (A) sensor key, then press the (B) and (C) sensor keys simultaneously. Another way to delete a setting is by setting the timer value to "0.00".

## Operating the oven

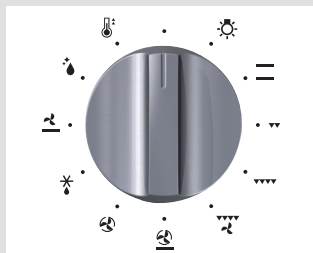

The oven is controlled by the on/off and operation mode selection knob and the electronic program timer with temperature display.

The on/off and operation mode selection knob

Rotate the selection knob to the desired cooking mode. The operation mode and the preset temperature will appear on the timer display. The oven starts to operate.

## Setting the oven temperature

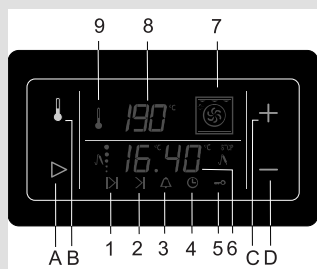

Use the electronic program timer to set the cooking temperature and timer functions:

- As soon as the selector knob (operation mode selection knob) is turned, the relevant cooking mode and the preset temperature are displayed; the symbol "°C" will flash for a few seconds.
- As long as the symbol "°C" is flashing, the sensor keys (C) and (D) can be used to set the required temperature in the interval from 30-275 °C, in 5°C steps. Maximum temperature is limited in some operation modes. Each time the sensor key is pressed, the temperature is changed by one step (5 °C); if the sensor key is pressed and held, the rate at which the value is changing will increase.
- Rising actual oven temperature is indicated on the display, in 5°C steps. As long as the oven temperature is less than 30°C, "---°C" will be displayed. Symbol (9) is also displayed, indicating the operation of the heaters.
- When the set temperature is reached, the symbol (9) will go off, and a short beep will sound.
- During cooking, the temperature is maintained by occasional activation of the heaters; each time this happens, the symbol (9) appears.
- Cooking temperature may be changed any time by touching the (B) sensor key, which makes the "°C" symbol flash for a while, and changing the value using the sensor keys (C) and (D).

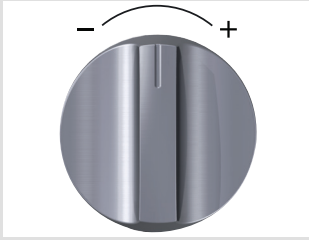

### Setting the temperature using a special knob (only with some models)

Temperature and other settings can also be adjusted using a special button which replaces touching the program timer sensor keys.

- Rotate the temperature selection knob (dial) to the right or to the left (clockwise or counterclockwise). The currently set temperature is displayed, and the symbol “°C” will flash.
- By rotating the knob or holding it in the position to the right or to the left, the temperature is changed in 5°C steps.

### Rapid oven preheating

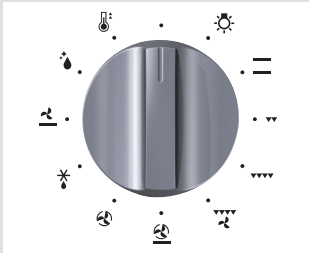

Use this system if you wish to quickly preheat the oven to the desired temperature. This mode is not appropriate for cooking food.

- Select the operation mode with the relevant selector knob .
- The oven starts heating up.
- If required, change the preset temperature.
- When the oven has heated to the preset temperature, the heating stops, and an intermittent beep sounds which can be deactivated by pressing any sensor key or rotating the selector knob; if non of this is done, the beep stops automatically after one minute.
- The oven is now ready for further cooking.

**The oven may be operated in the following modes**

**☀ Oven lighting**

With some models, there are two interior lighting lamps: one on the upper part of the back wall, and the other, additional lamp on middle of the right side wall. Oven lighting can be selected independently, without selecting another function. With all other modes of operation, the oven lighting is turned on automatically when the operation mode is selected.

**☰ Upper / lower heater**

The heaters on the upper and lower side of the oven radiate heat uniformly and evenly into the oven interior. Pastry and meat can be cooked on one shelf level only.

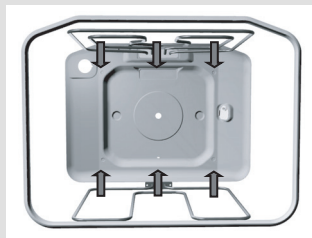

**☰☀ Large grill**

With this operation mode, the upper heater and the infra heater are activated simultaneously. The infra heater installed on the oven interior ceiling radiates heat directly. To boost the heating effect or to make optimal use of the entire area of the oven grid, the upper heater is also activated. This operation mode is appropriate for cooking smaller chunks of meat, such as steaks, roasts, chops, ribs, etc.



**☰☀ Grill**

Only the infra heater is activated (which also operates, along with the upper heater, in the Large grill mode). This mode is appropriate for grilling smaller quantities of toasted sandwiches, grill sausages, or simply for toasting bread.



**☰☀☀ Grill & fan**

With this operation mode, the infra heater and the fan are activated simultaneously. It is appropriate for grilling meat and large chunks of meat or poultry on one shelf level. Also appropriate for cooking food au gratin or browning.

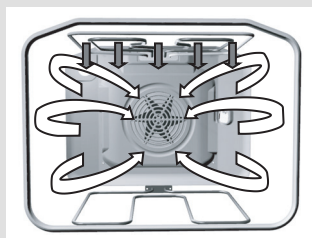

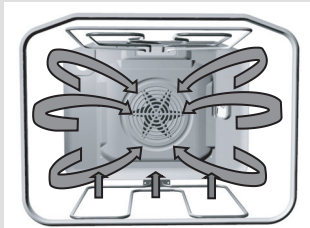

#### **Hot air and lower heater**

With this operation mode, the lower heater and the hot air fan operate simultaneously. This is particularly convenient for making pizza. Also ideal for moist or heavy pastry, fruit cakes made of leavened dough, short pastry, or cheesecakes.

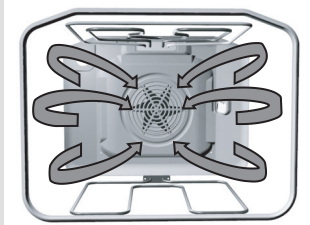

#### **Hot air**

With this operation mode, the round heater and the fan operate simultaneously. The fan at the oven back wall causes the hot air to circulate constantly around a roast of pastry. This operation mode is appropriate for roasting meat and making pastry on several shelves simultaneously. Cooking temperature should be set lower than with conventional operation modes.

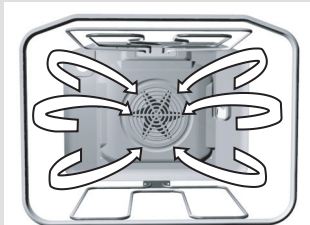

#### **Defrosting**

With this mode, the air is circulating without any heater being turned on. Only the fan is in operation. This is used for slow defrosting or thawing of frozen food.

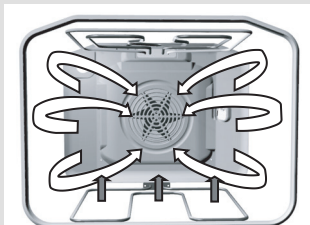

#### **Lower heater and fan**

With this operation mode, the lower heater and the fan operate simultaneously. Used for baking low leavened dough and preserving fruit and vegetables. Use the first shelf position from the bottom and shallow rather than deep baking trays to allow the warm air circulate around the upper side of the dish as well.



#### **Aqua Clean**

The heat is only radiated by the heater installed in the bottom of the oven. Select this operation mode when you wish to bake / cook the bottom side of the dish more thoroughly (e.g. for moist pastry with fruit filling). Set the temperature with the temperature selection knob /dial.

## Turning off the oven

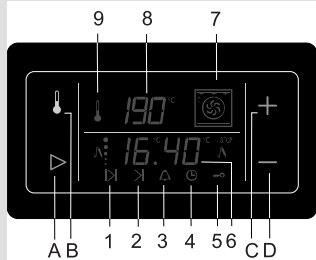

After the end of cooking process, rotate the selector knob to the “zero” position. This will also interrupt and delete all timer functions (see the section “Setting the timer functions”); the timer will switch to time of day / clock display.

After the end of cooking and when the oven is turned off, the temperature display will indicate the falling temperature until it reaches 50°C.

## Shelf levels (depending on the model)

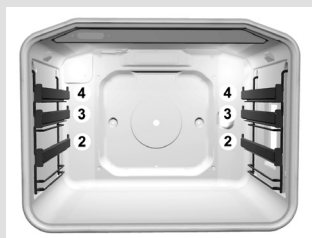
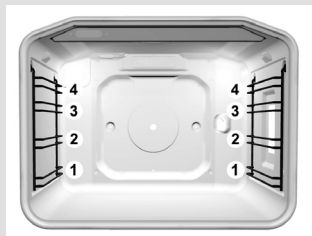
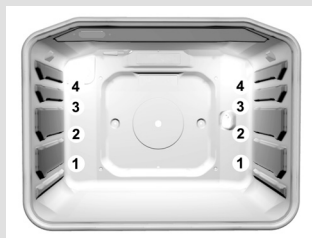

- Accessories (grid, shallow and deep baking tray) can be inserted into the oven at four levels.
- Please note that the shelf levels are always referred to by consecutive numbers starting from the bottom (particular shelf levels are described in the cooking tables below)
- The guides may be drawn, wire, or telescopic (depending on the appliance model). Telescopic (pull-out or retractable) guides are installed for the second, third, and fourth level. In case of wire guides, the grid and the trays should always be inserted into the leading slot formed by adjacent wire profiles.

### **Telescopic pull-out guides (depending on the model)**

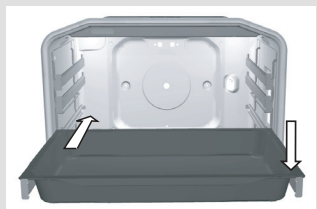
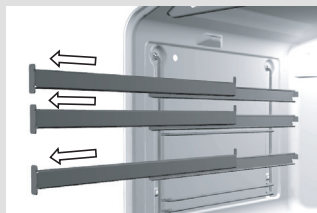

Telescopic (pull-out or, retractable) guides are installed for the second, third, and fourth level. They are installed on the left and right side wall of the oven interior at three levels.

Pull-out levels consist of (depending on the model):

- three guides that can be pulled out partially,
- one guide that can be pulled out completely and two that can be pulled out partially, or
- three guides that can be pulled out completely.

**⚠ Telescopic pull-out guides and other parts of oven accessories will heat up! Use a kitchen glove or similar protection when handling them.**

- To insert the grid, baking tray, or drip tray, first pull out the telescopic guides of the desired level.
- Place the grid or the shallow or deep baking tray on the pull-out guides and push it into the oven with your hand. Close the oven door only when the telescopic guides have been fully retracted.

### **Stainless steel profile (depending on the model)**

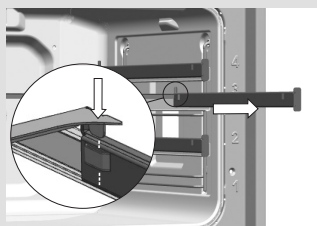

For easier insertion of the baking tray, the inserted profile allows both telescopic guides to be pulled out equally and simultaneously.

#### **Installation:**

- To insert the profile, first pull out both telescopic guides of the same level.
- Insert the profile into both slots at the rear side of each guide and push them with your hand until they stop.

### **Easy-clean inserts (depending on the model)**

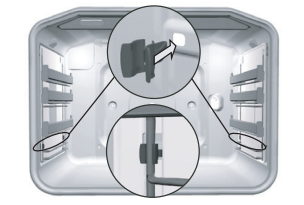
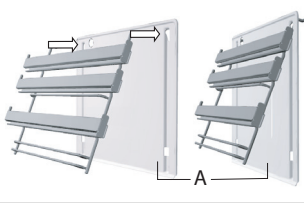

The easy-clean inserts prevent the fat from splattering directly on the oven wall.

#### **The easy-clean inserts are installed as follows:**

- Remove the wire or telescopic guides (see the section Removing the telescopic and wire guides).
- Attach the guides (wire or telescopic) to the easy-clean shield (A). Then, hang them together by sliding the two prongs into the provided hole and pulling the assembly downward.

When installing telescopic retractable guides (which can be pulled out completely) and the easy-clean inserts, insert the supplied clips into the lower openings on the oven interior walls, and insert the guides into these clips. The clips are intended for securing the guides.

### **Oven accessories (depending on the model)**



The glass tray is intended for baking dishes, but may also be used as a serving tray.

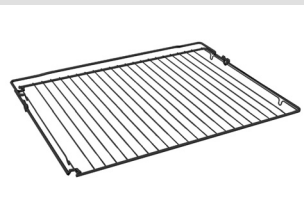

The grid onto which the container with food, or the food directly, is placed.

 **A safety stop is fitted on the grid and on the guides. To pull out the grid, lift it slightly when it hits the stop.**



**Shallow baking tray** is only intended for baking pastry and cakes.



**Deep baking tray** is intended for baking meat and moist pastry; it is also intended as a drip tray.



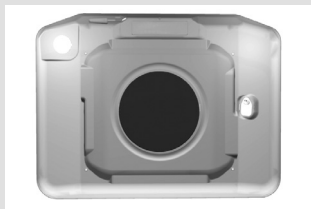

**Unless you are using the grill, or the deep baking tray is used only as a drip tray when spit-roasting, the deep tray should not be inserted into the first guide.**

***Fat filter (depending on the model)***



The fat filter installed on the back oven interior wall protects the fan, round heater, and the oven from impurity, particularly spattering fat. When cooking meat, we recommend using the fat filter. When baking pastry, always remove the filter! If the filter is installed when baking pastry or cakes, the results can be quite poor.

## Baking pastry

- For baking pastry, use the  or  mode of operation. (Oven operation with the selected mode, or system, depends on the appliance model).
- When baking pastry, always remove the fat filter.

### Instructions

- When baking pastry, always observe the instructions on the shelf / guide level, temperature, and cooking time indicated in the pastry baking table. Do not be prejudiced by experience you may have with other ovens. The values indicated in the cooking table are defined and checked especially for this particular oven.
- If the baking table does not specifically address a particular type of pastry, see the information for a similar type of pastry.

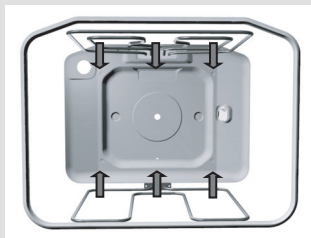

#### Baking pastry with upper and lower heater

- Bake the pastry at one level only.
- Upper / lower heater combination is particularly appropriate for baking various types of pastry, bread, and meat.
- Use dark-colored baking trays. Light-colored trays reflect the heat, which leads to poorer cooking (browning) results. Always place the models on the grid. If you are using the supplied baking tray, remove the grid.
- Preheating will shorten the cooking time. Place the dish into the oven only when the selected temperature has been reached, i.e. when the control lamp (heater operation lamp) goes off for the first time.

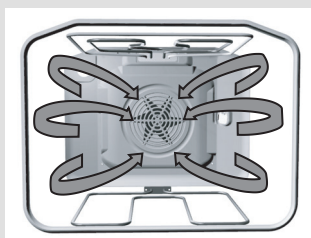

#### Baking pastry with hot air

Baking pastry with hot air is particularly convenient when you wish to bake on several shelf / guide levels simultaneously, especially when preparing bite-size pastry in shallow trays. Preheating is recommended, and the use of the second and third guide level. This mode is also appropriate for moist pastry and fruit cakes (in this case, bake on a single level only).

- The temperature is normally set lower than when baking with the upper/lower heater combination (see also the pastry baking table).
- Various types of pastry can be baked simultaneously, if the required temperature is at least approximately the same for all.
- Baking time can vary, even for equal baking trays. When baking in several baking trays simultaneously – on two or even three levels, baking time for each tray can be different. You may have to remove one of the trays sooner (normally, this would be the uppermost tray).
- If possible, prepare bite-size pastry, such as cupcakes, in the same thickness and height. Unevenly sized pastry will be unevenly browned!

- When baking several types of pastry simultaneously, there will be a significant amount of vapor in the oven, resulting in accumulation of condensate on the oven door.

### **Tips on baking pastry**

#### **Is the pastry completely done?**

Use a wooden stick to pierce the pastry at the highest point. If there are no traces of dough when the stick is removed, the pastry is done. Turn off the oven and use the remaining accumulated heat.

#### **The pastry has collapsed**

Check the recipe. Next time, use less liquid. Observe the instructions on mixing / kneading time, especially when using small household appliances.

#### **The pastry is too light-colored**

Next time, use a dark-colored baking tray, place the tray one guide level lower, or turn on the lower heater towards the end of the cooking process.

#### **The pastry with a moist filling (e.g. cheesecake) is not completely done**

Next time, reduce the temperature and extend the cooking time.

#### **Notes on the pastry baking table:**

- Two values are indicated for temperature, lower and upper. Initially, set the lower temperature; if the pastry is not brown enough, increase the temperature next time.
- Cooking times are given as an estimate and may vary subject to a number of circumstances.
- The value printed in bold in the temperature table indicates the most appropriate operating mode for a particular type of pastry.
- The indication \* means that the oven should be preheated with the corresponding operating mode selected.
- When using baking paper, make sure it is resistant to high temperature.

**Pastry baking table for combined upper and lower heater or hot air operating mode - when cooking on one level only**



Type of pastry	Guide (from the bottom)	Temperature (°C)	Guide (from the bottom)	Temperature (°C)	Cooking time (minutes)
<b>Sweet pastry</b>					
Marble cake, ring cake	1	160-170	1	150-160	50-70
Rectangle-shaped cake	1	160-170	1	150-160	55-70
Cake made in cake tin	1	160-170	2	150-160	45-60
Cake tin cheesecake	1	170-180	2	150-160	65-85
Fruit cake, short pastry	1	180-190	2	160-170	50-70
Fruit cake with dressing	1	170-180	2	160-170	60-70
Sponge cake*	1	170-180	2	150-160	30-40
Cake with icing	2	180-190	2	160-170	25-35
Fruit cake, mixed dough	2	170-180	2	150-160	45-65
Cherry cake	2	180-200	2	150-160	35-60
Sponge cake roll*	2	180-190	2	160-170	15-25
Leavened dough cake	2	160-170	2	150-160	25-35
Hefezopf (leavened dough)	2	180-200	2	160-170	35-50
Christmas cake	2	170-180	2	150-160	45-70
Apple pie	2	180-200	2	170-180	40-60
Oven-baked donuts	1	170-180	2	150-160	40-55
<b>Savory pastry</b>					
Quiche Lorraine	1	190-210	2	170-180	50-65
Pizza*	2	210-230	2	190-210	25-45
Bread	2	190-210	2	170-180	50-60
Buns*	2	200-220	2	180-190	30-40
<b>Bite-size pastry</b>					
Short pastry – cookies *	2	160-170	2	150-160	15-25
Merengue *	2	160-170	2	150-160	15-28
Leavened dough	2	180-190	2	170-180	20-35
Puff pastry	2	190-200	2	170-180	20-30
Choux pastry (cream filled)	2	180-190	2	180-190	25-45
<b>Soufflés</b>					
Rice soufflé	1	190-200	2	180-190	35-50
Fresh cheese soufflé	1	190-200	2	180-190	40-50
<b>Frozen pastry</b>					
Apple, cheese pie	2	180-200	2	170-180	50-70
Cheesecake	2	180-190	2	160-170	65-85
Pizza	2	200-220	2	170-180	20-30
French fries for oven *	2	200-220	2	170-180	20-35
Croquettes	2	200-220	2	170-180	20-35

**Note:** Guide number refers to the grid onto which smaller baking trays or cake tins are placed, and to shallow baking tray. The deep baking tray should not be inserted into the first guide.

## Settings table for baking pastry with hot air and lower heater

Type of pastry	Guide (from the bottom)	Temperature (°C)	Cooking time (minutes)
Cheesecake (750g cheese) - short pastry	2	150-160	65-80
Pizza * - leavened dough	2	200-210	15-20
Quiche Lorraine - short crust dough	2	180-200	35-40
Apple pie with icing - leavened dough	2	150-160	35-40
Fruit cake - mixed dough	2	150-160	45-55
Apple pie - flaky pastry	2	170-180	45-65

## Cooking / roasting meat

- To cook meat, use the operating modes **•**  and .
- Data printed in bold represent the most appropriate operation mode for a particular type of meat.
- When cooking meat, the use of the fat filter is recommended (depending on the model).

### Tips on using the cookware

- Meat can be cooked in enamel coated cookware, tempered glass (Pyrex) cookware, clay, or cast iron cookware.
- Stainless steel baking trays are less appropriate because they reflect the heat.
- If the roast is covered, it will remain juicier, and the oven will not be as dirty.
- In an open baking tray, the roast will brown sooner.

### Some notes on cooking meat

- The meat cooking table indicates recommended temperatures, guide/shelf level, and cooking time. Since cooking times depend strongly on the type, weight, and quality of meat, they may have to be adjusted.
- Cooking meat, poultry, and fish in an oven is economical only at weights exceeding 1 kg.
- When cooking meat, add enough liquid to prevent the fat and juices from the meat to be burnt onto the baking tray. This means that, in case of longer cooking times, the roast should be checked upon every one in a while, and liquid should be added.
- After approximately half of cooking time, turn the roast around, especially when baking in a tray. For better results, start the cooking with the upper side turned downwards.
- When cooking larger chunks of meat, condensate may accumulate on the oven door. This is a natural phenomenon which does not affect the operation of the appliance. After cooking, wipe the door and door glass dry.
- In order to prevent accumulation of condensate, do not let the dishes to cool down in the oven.

## Meat cooking table for upper/lower heater combination or with hot air - when cooking on one level only

Type of meat	Weight (g)	Guide (from bottom)	Temperature (°C)	Guide (from bottom)	Temperature (°C)	Cooking time (min.)
<b>Beef</b>						
Beef roast	1000	2	190-210	2	180-190	100-120
Beef roast	1500	2	190-210	2	170-180	120-150
Roastbeef, medium done	1000	2	200-210	2	180-200	30-50
Roastbeef, well done	1000	2	200-210	2	180-200	40-60
<b>Pork</b>						
Pork roast, incl. skin	1500	2	180-190	2	170-180	140-160
Pork belly	1500	2	190-200	2	170-180	120-150
Pork belly	2000	2	180-200	2	160-170	150-180
Shoulder	1500	2	190-200	2	160-170	120-140
Pork roll	1500	2	190-200	2	160-170	120-140
Cutlet	1500	2	180-200	2	160-170	100-120
Minced meat roast (pork meat loaf)	1500	2	200-210	2	170-180	60-70
<b>Veal</b>						
Veal roll	1500	2	180-200	2	170-190	90-120
Veal joint	1700	2	180-200	2	170-180	120-130
<b>Lamb</b>						
Lamb loin	1500	2	190-200	2	170-180	100-120
Sheep joint	1500	2	190-200	2	170-180	120-130
<b>Venison</b>						
Rabbit loin	1500	2	190-200	2	180-190	100-120
Deer joint	1500	2	190-200	2	170-180	100-120
Wild boar joint	1500	2	190-200	2	170-180	100-120
<b>Poultry</b>						
Chicken, whole	1200	2	190-200	2	180-190	60-80
Chicken	1500	2	190-200	2	180-190	70-90
Duck	1700	2	180-190	2	160-170	120-150
Goose	4000	2	160-170	2	150-160	180-200
Turkey	5000	2	150-160	2	140-150	180-240
<b>Fish</b>						
Whole fish	1000	2	190-200	2	170-180	50-60
Fish soufflé	1500	2	180-200	2	150-170	50-70

**Note:** The indication of recommended guide relates to the deep tray; smaller trays should be placed on the grid inserted into the first or second guide (do not insert the deep tray on the first guide).

- When grilling meat, you should be particularly careful. The high temperatures and infra heater heat the grid and other parts of the oven to very high degrees; use protective kitchen gloves and special meat tongs.
- Hot fat may squirt out of pierced meat (e.g. from sausages). To avoid burning your skin or eyes, use meat tongs.
- When grilling meat, control the process at all times. Due to high temperature, meat can be burnt quickly!
- Do not let children anywhere near the grill.
- Roasting with infra heater is recommended for crisp and low-fat preparation of grilled sausages, meat chunks, and fish (steak, chops, salmon fillets, etc.) or toasted bread, as well as for browning.

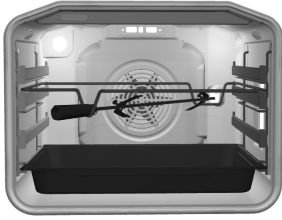

### Some tips on using the grill function

- When using the grill, oven door should always be closed.
- The cooking table for grilling indicates recommended temperature, guide level, and cooking time. Since cooking time depends strongly on the type, quality, weight, and quality of meat, it may have to be adjusted.
- When cooking meat, the use of fat filter is recommended (depending on the model).
- The infra heater (Large grill and Grill operating mode) should be preheated for five minutes.
- When cooking on a grid, spread some oil over it to prevent the meat from sticking onto it.
- Place thin slices of meat on the grid and insert it into the fourth guide level.
- Insert a baking tray, which will serve as a drip tray in this case, into the first or second guide level to collect the dripping fat and meat juices.
- Grilled meat should be turned halfway through the cooking. Cook the first side somewhat longer than the other one.
- When grilling larger chunks of meat on a grid (chicken, fish), insert the grid into the second level and the drip tray into the first level.
- Thinner slices of meat should only be turned once, while the thicker ones should be turned several times. Use meat tongs to turn the meat around, to prevent too much juice to be lost.
- Darker meat will brown better and sooner than pork or veal.
- After using the grill, clean the oven and accessories each time to prevent the dirt to be burnt onto the oven the next time you use it.



## Spit roasting

(only with some models)

- The rotating roast spit set consists of a rotating spit with a detachable handle and two forks with screws for fixing the meat chunk.
- When using the roast spit, first insert the special support frame into the third guide from the bottom. Spit the seasoned meat and stick the support forks into the meat chunk from each side to firmly fix it. Then, tighten the screws on the forks.
- Install the handle on the front part of the roast spit. Stick the pointed part of the spit into the opening on the right side of the back oven door, which is protected by a rotating shutter. Place the front part of the spit into the lowest part of the support frame until it snaps into place.
- Insert a deep tray, which will serve as a drip tray in this case, one level lower than the deep tray to prevent the fat and juices dripping from the meat from accumulating on the oven bottom.
- Activate the spit roast by selecting the operation mode “Large grill”  or “Grill” .
- Before closing the oven door, detach the spit handle.
- The infra heater operation is controlled by a thermostat; also, it only works when the door is closed.

## Cooking table - Large grill

Type of food	Weight (g)	Guide level (from bottom)	Temperature (°C)	Temperature (°C)	Cooking time (min)
<b>Meat and sausages</b>					
4 beef loin chops, rare	180g/pc	4	240	-	14-16
4 beef loin chops, medium	"	4	240	-	16-20
4 beef loin chops, well done	"	4	240	-	18-21
4 pork neck chops	"	4	240	-	19-23
4 cutlets	"	4	240	-	20-24
4 veal steaks	"	4	240	-	19-22
6 lamb cutlets	100g/pc	4	240	-	15-19
8 grill sausages	100g/pc	4	240	-	11-14
3 pcs of meatloaf	200g/pc	4	240	-	9-15
1/2 chicken	600g	2	-	180-190	25 (1. side) 20 (2. side)
<b>Fish</b>					
Salmon slices	600	3	240	-	19-22
4 trout	200g/pc	2	-	170-180	45-50
<b>Toasted bread</b>					
6 slices white bread	/	4	240	-	1,5-3
4 slices of mixed flour bread	/	4	240	-	2-3
Toasted sandwich	/	4	240	-	3,5-7
<b>Meat / poultry*</b>					
Duck*	2000	2	210	150-170	80-100
Chicken*	1500	2	210-220	160-170	60-85
Pork roast	1500	2	-	150-160	90-120
Pork shoulder	1500	2	-	150-160	120-160
Pork joint	1000	2	-	150-160	120-140
Roastbeef / beef loin	1500	2	-	170-180	40-80
<b>Vegetables au gratin **</b>					
Cauliflower, kale	750	2	-	210-230	15-25
Asparagus	750	2	-	210-230	15-25

**Note:** the guide level refers to the grid on which you place the meat; in the section meat/poultry, the guide level refers to the deep tray, while with chicken, it refers to the grid.

When cooking meat in a tray, make sure there is enough liquid in the tray to prevent the meat from burning; approximately halfway through the cooking progress, turn the chunk of meat around. When grilling meat on the grid, insert the deep tray into the first or second guide; this way, it will serve as a drip tray (see tips on grilling meat).

**Recommendation:** Dry the trout with a paper towel. Put some parsley, salt, and garlic into the fish abdomen, oil it from the outside, and place it on the grid. Do not turn during grilling.

\* This type of meat can also be prepared on a roast spit (see instructions for spit roasting).

\*\* Vegetables are first partly cooked and covered in béchamel sauce and grated cheese. Use the smaller glass baking tray and place it on the grid.

## Cooking table - grill

Food type	Weight (g)	Guide level (from bottom)	Temperature (°C)	Temperature (°C)	Cooking time (min.)
<b>Meat and sausages</b>					
2 beef loin stakes, well done	180g/pc	4	240	-	18-21
2 cutlets		4	240	-	20-22
2 pork neck steaks	180g/pc	4	240	-	18-22
4 grill sausages	100g/pc	4	240	-	11-14
4 toasted sandwiches		4	240	-	5-7
Toast - browning		4	240		3-4
3 trout - on the grid	200g/pc	2	-	160-170	40-50
Chicken - on the grid	1500g	2	-	160-170	60-80
Pork shoulder - deep tray	1500g	2	-	150-160	120-160

## Programmed cooking using the meat probe

With this programming mode, set the desired temperature in the core of the food (e.g. chunk of meat). Settings between 30 and 99°C are possible.

The oven will operate until the core reaches the set temperature. The temperature is measured by the temperature probe. Cooking with a probe is suitable for preparing large chunks of meat, preferably without bones. Chicken and rabbit are not appropriate for such mode of preparation.

Recommended core temperatures:

Pork roast	85°C
Beef roast	80 °C
Veal roast	75 °C
Tender loin (filet mignon)	40-50 °C

### Procedure of cooking meat with the probe:

- Insert the probe plug into the socket and stick the probe into the piece of meat (or other food). The probe contains a metal plug that has to be removed before the cooking and replaced afterwards.
- As soon as the probe is connected, the temperature read by the probe is displayed on the timer, instead of the clock. If any timer functions were set previously, they will be deleted automatically.
- In addition to the preset temperature (70°C), the symbol "°C" will flash for a few seconds. As long as the symbol is flashing, use the (C) and (D) sensor keys to set the desired temperature in the range from 30 to 99 °C; the temperature can be set in 1°C steps.
- If the "°C" symbol has already stopped flashing, press the sensor key (A) first to make any changes to the target probe temperature.

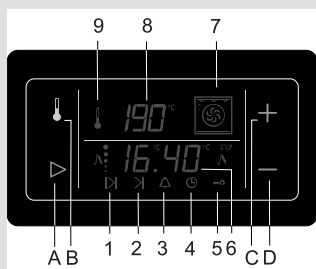

- Set the operation mode selection knob to the desired cooking mode. We recommend using the upper and lower heater mode. The oven starts to operate.
- During cooking, the rising temperature in the core of the food is constantly displayed. Until the temperature reaches 30°C, the display reads ("--").
- Both cooking temperature and the probe target temperature can be changed any time during operation by pressing the relevant selection sensor key.
- When the set temperature of the food core has been reached, the oven stops operating, The symbol STOP lights up and flashes. An intermittent beep is sounded, which can be turned off by pressing any sensor key or rotating the selector knob in any direction; if none of this is done, the beeping will stop after one minute.
- Turn off the oven and remove the probe from the food and the socket. Replace the protective metal plug back into the probe socket.



**Make sure the probe does not touch the heater while the oven is in operation. Use only the probe intended to be used with this type of oven.**

## Preservation

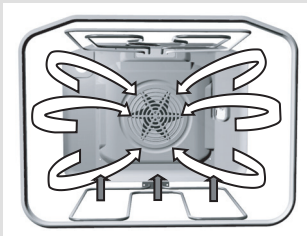

### For food preservation, use the lower heater + fan operating mode.

Prepare the food to be preserved and the jars as usually. Use conventional jars with a rubber sealing and glass cover. Do not use jars with threaded or metal covers and metal cans / tins. Preferably, the jars should be of the same size, filled with the same type of food, and tightly sealed. Up to six one-liter jars can be placed into the oven simultaneously.

- Only use fresh food.
- Pour approximately one liter of hot water (about 80 °C) into the deep baking tray to provide the required humidity level in the oven. Place the jars into the oven in such way that they are not in contact with the walls and each other (see figure). Rubber seals should be wetted before use.
- Insert the deep tray with the jars into the second guide level from bottom up. During preservation, observe the jars; cook until the contents of the jars starts to boil – bubbles appear in the first jar. Please note the cooking times from the preservation table below.

## Preservation table

Food to be preserved	Quantity	T=170-180°C, until boiling / bubbling (min.)	After appearance of bubbles	Standing time (in the oven (min))
<b>Fruit</b>				
Strawberries	6x1 liter	approx. 40-55	turn off	25
Stone fruit	6x1 liter	approx. 40-55	turn off	30
Apple puree	6x1 liter	approx. 40-55	turn off	35
<b>Vegetables</b>				
Sour gherkin	6x1 liter	approx. 40 do 55	turn off	30
Beans, carrots	6x1 liter	approx. 40 do 55	Set to 120°C, 60 min	30

**Durations:** given in the chart are approximate only. Actual time may vary de to differences in room temperature, number of jars, quantity and temperature of the fruit and vegetables to be preserved, etc. Before turning off the oven (for fruit) or setting a lower temperature (for some types of vegetables), make sure there are actually visible bubbles in the jars.

Important: Observe carefully when the bubbles appear in the first jar.

## Defrosting

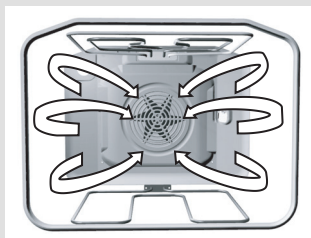

- Air circulating in the oven may speed up the process of defrosting frozen food. To do this, set the oven to “Defrosting” mode ☼.

**⚠ If the temperature setting button is accidentally activated, the oven control lamp will light up, but the heaters will not be activated.**

- Food appropriate for defrosting includes cakes with heavy cream or butter-based filling, other cakes and pastry, bread, buns, and deep-frozen fruit.
- For reasons of hygiene, meat and poultry should not be defrosted in an oven. If possible, turn the food around or mix several times to make sure they are defrosted evenly.

## Cleaning and maintenance

Do not use a steam cleaner or a high-pressure steam cleaner to clean the appliance. Before you start cleaning the appliance, disconnect it from the power mains and let it cool down.

### **Appliance housing front**

Clean the surfaces with liquid non-abrasive detergents intended for smooth surfaces, and a soft cloth. Apply the detergent on the cloth and wipe off the dirt; then, rinse with water. Do not apply the detergent directly on the surfaces. Do not use aggressive or abrasive cleaners, sharp objects or steel wool, as these will scratch the appliance.

### **Aluminum surfaces**

Aluminum surfaces should be cleaned with non-abrasive liquid detergents intended for such materials. Apply the detergent on a wet cloth and clean the surface; then, rinse the surface with water. Do not apply the cleaner directly on the aluminum surface. Do not use abrasive cleaners or abrasive sponges. The surface should not come into contact with oven cleaning sprays.

### **Stainless steel front panels**

(only with some models)

Clean the surface with a mild cleaner (soapsuds) and a soft sponge that will not scratch the material. Do not use abrasive or solvent-based cleaners. If these instructions are ignored, the housing surface can be damaged.

### **Lacquer-coated and plastic surfaces**

(only with some models)

Clean the buttons / knobs and the door handle with a soft cloth and liquid detergents intended for cleaning smooth lacquer-coated surfaces. You may also use the cleaners made especially for this type of surfaces; in this case, follow the manufacturer's instructions.

**WARNING:** The above surfaces should never come into contact with oven cleaning sprays, as these will permanently damage the aluminum parts.

### Oven

- The oven can be cleaned in conventional manner (with detergents, oven spray), but only when it is very dirty and when the stains are particularly stubborn.
- For regular cleaning of your oven (after each use), the following procedure is recommended: rotate the operation mode selection knob to the position . Set the temperature selection knob / dial to 70°C. Pour 0.6 liter of water into a baking tray and insert it into the lowermost guide. After thirty minutes, the food residues on the enamel will have softened, allowing you to wipe them with a damp cloth.

### **When dealing with stubborn stains, please note the following:**

The oven should be cooled down before each cleaning process.

- Clean the oven and accessories after each use to prevent the dirt from being burnt onto the oven.
- The easiest way to remove grease is by using warm soapsuds while the oven is still warm.
- In case of particularly stubborn dirt, use the conventional oven cleaners. Then, rinse the oven thoroughly with clean water to remove all residues of the cleaner.
- Never use aggressive cleaners such as steel wool, abrasive dishwashing sponges, stain removers, etc.
- Lacquer-coated, stainless steel, and zinc-coated surfaces, as well as aluminum parts, should never come into contact with oven cleaning sprays, as these may cause damage and discoloration. The same applies for the thermostat sensor (if the cooker features a timer with a probe) and the heaters accessible at the upper part.
- When purchasing and dispensing detergents, consider the environment and observe the instructions provided by respective cleaning agent manufacturers.

### **Practical tip**

- When cooking larger fatty chunks of meat, we recommend wrapping them in aluminum foil or a suitable cooking bag, to prevent the grease from being splattered on the oven interior walls.
- When grilling meat on the grid, place a drip tray underneath.

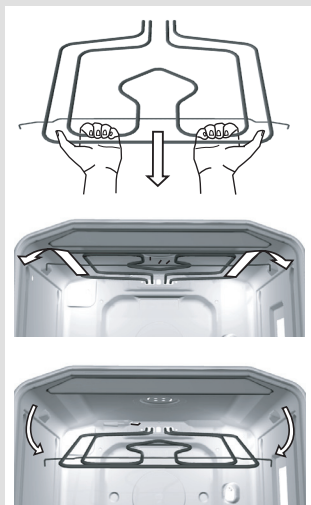

### **Cleaning the oven interior ceiling (only with some models)**

- To facilitate cleaning of the oven interior upper wall, some appliances feature a foldable upper infra heater.
- Before lowering the heater, the cooker must be disconnected from the power mains by removing the fuse or tripping the main switch.
- The heater should be cooled down; otherwise there is a risk of burning!
- Do not use the heater when it is lowered!

Before cleaning the oven, remove the baking trays, the grid, and the guides. Then, pull the horizontal heater towards yourself. Pull the heater until the crossbar is released from the supports on the left and right side of the oven (see figure). After cleaning, replace the heater following the same procedure; the crossbar must be reinserted into the two support brackets.

### **Accessories**

Wash the accessories (baking trays, grid, etc.) with hot water and some conventional detergent.

### **Grease filter (only with some models)**

After each use, clean the grease filter with a soft brush in hot water and some detergent, or wash it in a dishwasher.

### **Easy-clean inserts (only with some models)**

After each use, clean the easy-clean inserts in water with some detergent, using a soft brush, or wash them in a dishwasher.

### **Special enamel coating**

The oven, interior side of the door, and baking trays, are covered with special enamel that has a smooth and resistant surface. This special layer enables easier cleaning at room temperature.

## **Maintenance (depending on the model)**

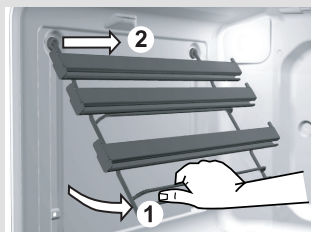

### **Removing the telescopic pull-out guides**

To facilitate cleaning of the oven interior side walls, the telescopic pull-out guides can be removed

- Hold the guide rack by its lower end and rotate it inwards; then, remove them from the holes on the upper side.
- Clean the racks with telescopic guides only with conventional cleaners.
- Do not wash the telescopic pull-out guides in a dishwasher.

**⚠ Do not attempt to grease the telescopic retractable guides.**

After cleaning, simply replace the guide rack by following the procedure in reverse order.

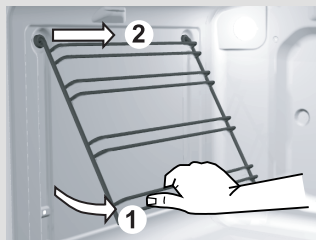

### Removing wire guide racks

To facilitate cleaning of the oven interior side walls, the wire guide rack can be removed.

- Hold the guide rack by its lower end and rotate it inwards;
- then, remove them from the holes on the upper side.
- Clean the guide racks guides only with conventional cleaners.
- After cleaning, simply re-hang the guide rack in the holes provided and pull the downwards.

### REMOVING INSIDE DOOR GLASS – APPLIES TO PREMIUM FULL-GLASS DOOR (make A and B)

Door glass can also be cleaned from the interior side; however, door has to be removed first (see section on removing and replacing the oven door).

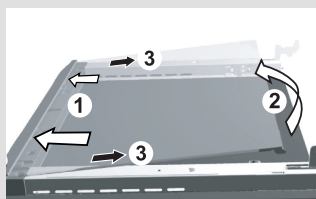

figure 1

a)

- Hold the door glass pane by its lower edge. Pull it gently towards yourself and lift it slightly – but not too far – by a maximum of 10 mm, until the glass support wedge slips out of the groove (Figure 1).
- Remove the glass (in the direction of arrow 3).

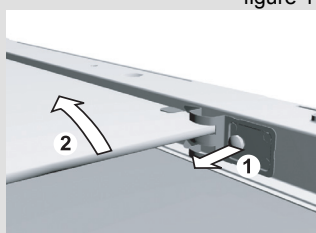

figure 2

- Interior glass (only in some models) is removed by first undoing the screws on the glass supports and then by lifting it (Figure 2). Remove the supports before cleaning the glass pane.

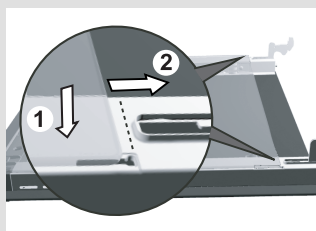

figure 3

- Reinstall the door by following the same procedure in reverse order.  
Note: Insert the glass into the slot and push it forward (Figure 3).

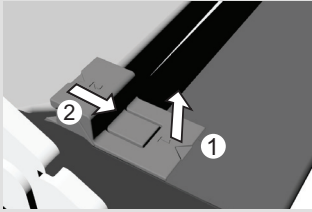

figure 1

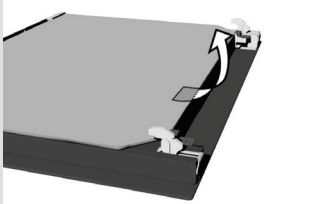

figure 2

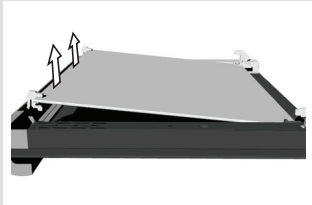

figure 3

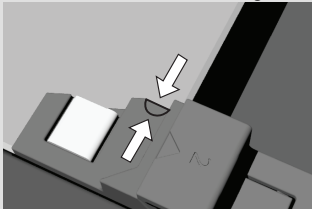

figure 4

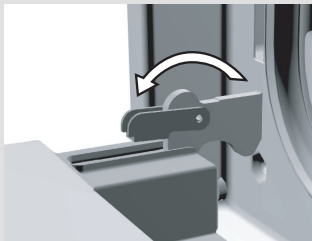

figure 1

b)

- Slightly lift the supports on the left and right side of the door (marking 1 on the support) and pull them away from the glass (marking 2 on the support) (see Figure 1).

- Hold the door glass by the lower edge, slightly lift it so that it is no longer attached to the support, and remove it (Figure 2).

- To remove the third inside glass (only with some models), lift and remove it. Also remove the rubbers on the glass (Figure 3).

- To replace the door, observe the reverse order.

**Note: To replace the glass, make sure the markings (crescent) on the door and the glass are aligned (Figure 4).**

### Removing and inserting the oven door with a single-axis hinge

Completely open the oven door and rotate the attachment clips completely backwards (Figure 1).

- Slowly close the door until the clips are pressed against the supports / seats. At approximately 15° (relative to the closed door position), pull the door slightly upward and pull them out of the both hinge supports on the appliances (Figure 2).
- Replace the door in the reverse order. Insert the door under an angle of 15° into the hinge supports at the front side of the appliance and push them downwards and to the front until they slide into their supports / seats.
- Then, completely open the door and rotate the attachment clips back to their initial position. Slowly close the door and

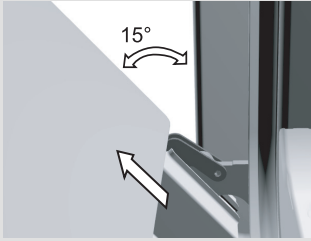

figure 2

check, if they close properly. If the door does not open or close correctly, make sure whether the hinge notches are correctly placed in their seat hinges.

**Attention**

Always make sure the hinge attachment clips are firmly seated in their supports when installing the door. If this is not the case, the main hinge that is operated by a strong spring may be released any time while installing or removing the door. Risk of physical injury.

**Door lock (only with some models)**

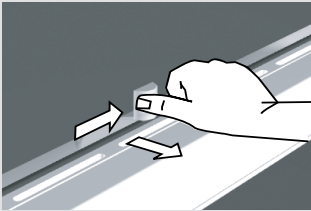

- Oven door is fitted with a door lock that prevents it from being open until the lock is released. Door lock is opened by a slightly pressing your thumb to the right and simultaneously pulling the door outwards.
- When the oven door is closed, the door lock automatically returns to its initial position.

**Note:** If the door lock is supplied with the appliance, attach it under the appliance control panel in compliance with the instructions for installation, which are supplied with the lock.

**Replacing appliance parts**

**The oven lamp base and socket are under voltage. There is a risk of electric shock!**

Before replacing the oven lighting bulb, disconnect the cooker from the power mains by removing the fuses or tripping the main network switch.



**Oven bulb**

(only with some models)

Oven bulb is considered a replacement ware part and is not covered by the warranty. Replace the bulb with a new one with the following specifications: socket E 14, 230 V, 25 W, 300°C.

- Unscrew the glass cover in the counterclockwise direction, replace the bulb, and replace the cover.

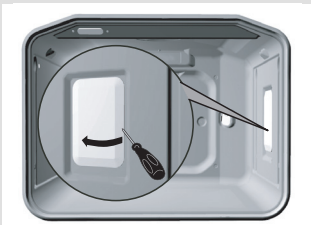

Bulb lamps used in this appliance are special purpose lamps selected for household appliances use only. They are not suitable for household room illumination.

## Special warnings and error reporting

**During the warranty period, any repairs may only be performed by service technicians authorized by the appliance manufacturer.**

Before starting the repair, the appliance must be disconnected from the power mains by removing the fuse or by removing the mains cord from the wall outlet.

Unauthorized tampering and repairs may cause the risk of electric shock and short circuit; therefore, do not attempt them yourselves. Leave such tasks to an expert or an authorized service technician.

In case of minor faults or problems with the appliance operation, check the following instructions to see whether you can eliminate the causes by yourselves.

### **Important**

A visit by a service technician during the warranty period will be charged if the appliance is not functioning because of improper use. Store these instructions in a place where they are always readily accessible; if pass the appliance on to another person, the instructions should also be included.

Following is some advice on rectifying some common problems.

Sensors do not respond, the display has frozen.	<ul style="list-style-type: none"><li>• <b>Disconnect the cooker from the power network for a few minutes (remove the fuse or trip the main switch); then, reconnect it to the power network and turn on the oven.</b></li></ul>
The main fuse is tripped repetitively...	<ul style="list-style-type: none"><li>• <b>Call a service technician!</b></li></ul>
Oven interior lighting does not work...	<ul style="list-style-type: none"><li>• <b>The process of replacing the bulb is described in the section “Appliance part replacement”.</b></li></ul>
The oven does not heat up...	<ul style="list-style-type: none"><li>• Was the temperature and operating mode selected appropriately?</li><li>• Is the oven door closed?</li></ul>
The pastry is not cooked thoroughly...	<ul style="list-style-type: none"><li>• Have you removed the grease filter?</li><li>• Did you observe the instructions and tips from the section “Baking pastry”?</li><li>• <b>Did you follow the instructions in the baking table closely?</b></li></ul>
The program timer shows extraordinary figures or is turned on and off uncontrolled...	<ul style="list-style-type: none"><li>• In case of faulty operation of the program timer, disconnect the cooker from the power mains for a few minutes (remove the fuse or trip the main switch); then, reconnect it to the mains and set the time of day.</li></ul>

Program timer display is blinking	<ul style="list-style-type: none"> <li>• There was a power supply failure, or your cooker was just connected to the power mains. All set times have been deleted.</li> <li>• Set the time of day to enable operation of the appliance.</li> <li>• After the operation has been over, the oven switches off, and clock flashes. Take the dish from the oven and turn the clock off.</li> </ul>
Operation control lamp is not lit...	<ul style="list-style-type: none"> <li>• Did you activate all necessary controls?</li> <li>• Did the main fuse in your home network trip?</li> <li>• Are the temperature knob /dial and the operating mode selection knob set properly?</li> </ul>

If the problem persists despite observing the instructions above, call an authorized service technician. Elimination of any errors or warranty claims that resulted from improper connection or use of the appliance is not covered by our warranty. In such cases, the costs of repair are borne by the user.

## Instructions for installation and connection

### Important warnings

- The appliance may only be connected by a qualified expert.
- The appliance should be fitted with a device that disconnects it from all poles of the home network (an omnipolar switch), with at least 3 mm of distance between the contacts in open position. LS-switches or fuses are appropriate.
- To connect the appliance, use the rubber mains cords (type HO5RR-F with the green/yellow earth wire), PVC insulated (type HO5VV-F with the green/yellow earth wire), or other equivalent or superior cables.
- Veneer, glue, or plastic finish of the furniture next to which the cooker is installed, should be treated heat resistant (>75°C). If the veneers are not high temperature resistant, they may be deformed.
- Packaging (plastic foil, polystyrene, etc.) must be kept out of reach of children, as it can be a source or threat to them. Small parts can be swallowed by the children, and the foils are hazardous because of the risk of suffocation.

### Installation

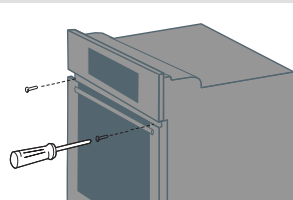

- Veneer or other finish of the furniture the appliance is being built into should be processed with heat-resistant glue (100°C); otherwise, high temperatures may cause them to deform.
- Before installing the appliance, remove the back wall from the piece of kitchen furniture the appliance is being built into, along the entire length of the cutout.
- The installation cutout should be dimensioned as indicated in the figure.
- The bottom panel of the piece of kitchen furniture (max. 530 mm) should always be shorter than the side walls to enable adequate air circulation.

- Level the piece of furniture the appliance was built into with a spirit level.
- The piece of kitchen furniture the appliance is built into must be secured against movement, e.g. attached to the adjacent pieces of kitchen furniture.
- Push the appliance into the kitchen furniture element enough that the guides for the screws that are inserted in the oven frame holes are placed against the kitchen element side walls.
- When attaching the appliance, make sure the screws are not fastened too strongly as this may damage the furniture or the appliance enamel coating.

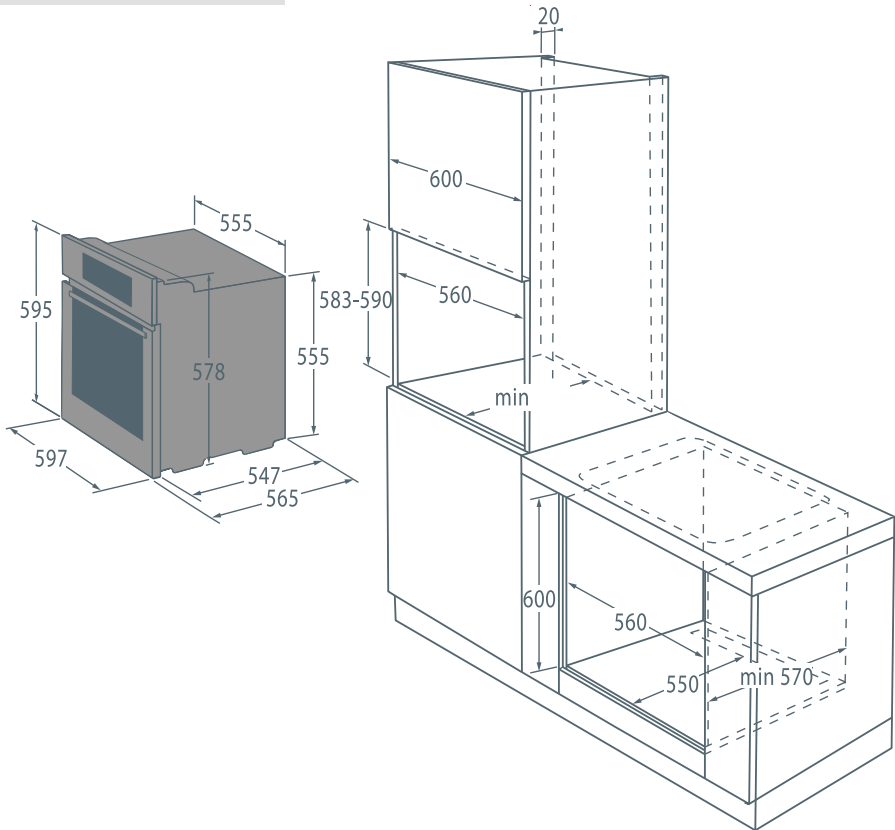

## Connection

The appliance may only be connected to the power mains by an authorized service technician or a registered electrician! Incorrect connection may result in damage to or destruction of respective parts of the appliance; in such cases, the warranty is void.

- Open the connection clip using a screwdriver, as indicated on the figure on the cover.
- The voltage (230V against N) in your home network must be checked by an expert using appropriate equipment!
- The connection bridges must be placed in compliance with the network connection!
- Before connection, make sure the voltage on the rating plate is consistent with the actual network voltage.
- The length of the power cord should be at least 1.5 meters; thus, the appliance can be connected before it is pushed to the wall.
- The length of the power cord should be adjusted in such way that in case of pulling load on the cable, the ground wire is strained later than the voltage wires.

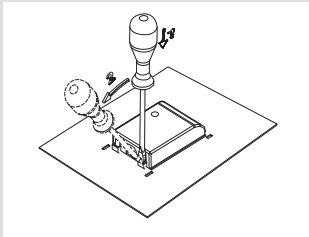

### Procedure

- Use a screwdriver to open the cover of the connection terminal on the back of the appliance. Release the two clips as indicated on the cover of the connection terminal.
- The mains cord must be inserted into the strain release device which protects the cable from being pulled out. If the strain release device is not installed yet, install it in such way that it gets stuck in the connection terminal housing at one end.
- Then, connect the appliance according to the instructions indicated on the figures. If network voltage is different, the connection bridges should be replaced.
- Firmly fasten the strain release device and close the cover.

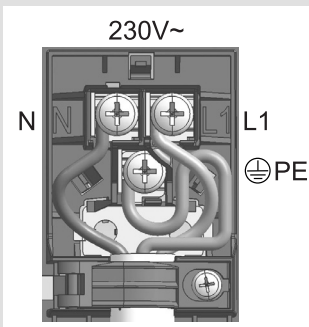

### Lead colors

L1, L2, L3 = external leads under voltage (live wires). Normally, the lead colors are black, black, brown.

N = neutral lead, normally blue.

Make sure the N-lead is connected correctly!

PE = protection, or earth (ground) lead

This wire is green-yellow.

# Technical characteristics

## Rating plate

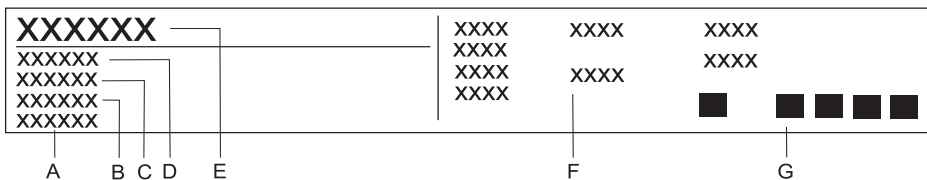

- A** Serial number
- B** Code
- C** Model
- D** Type
- E** Trademark
- F** Technical information
- G** Compliance indications / symbols

WE RESERVE THE RIGHT TO MAKE ANY CHANGES THAT DO NOT AFFECT THE FUNCTIONALITY OF THE APPLIANCE.







The appliance identification card is located on the bottom of the appliance.

Stick the appliance identification card here.

When contacting the service department, have the complete type number to hand.

You will find the addresses and phone numbers of the service organisation on the guarantee card.



418671

en (12-13)