

FLUKE®

902

HVAC Clamp Meter

Users Manual

PN 2547887

May 2006 Rev. 1, 3/07

© 2006-2007 Fluke Corporation. All rights reserved. Printed in China.

All product names are trademarks of their respective companies.

LIMITED WARRANTY AND LIMITATION OF LIABILITY

This Fluke product will be free from defects in material and workmanship for three years from the date of purchase. This warranty does not cover fuses, disposable batteries, or damage from accident, neglect, misuse, alteration, contamination, or abnormal conditions of operation or handling. Resellers are not authorized to extend any other warranty on Fluke's behalf. To obtain service during the warranty period, contact your nearest Fluke authorized service center to obtain return authorization information, then send the product to that Service Center with a description of the problem.

THIS WARRANTY IS YOUR ONLY REMEDY. NO OTHER WARRANTIES, SUCH AS FITNESS FOR A PARTICULAR PURPOSE, ARE EXPRESSED OR IMPLIED. FLUKE IS NOT LIABLE FOR ANY SPECIAL, INDIRECT, INCIDENTAL OR CONSEQUENTIAL DAMAGES OR LOSSES, ARISING FROM ANY CAUSE OR THEORY. Since some states or countries do not allow the exclusion or limitation of an implied warranty or of incidental or consequential damages, this limitation of liability may not apply to you.

Fluke Corporation
P.O. Box 9090
Everett, WA 98206-9090
U.S.A.

Fluke Europe B.V.
P.O. Box 1186
5602 BD Eindhoven
The Netherlands

11/99

Table of Contents

| Title | Page |
|---|------|
| Introduction..... | 1 |
| Contacting Fluke | 2 |
| Safety Information | 3 |
| Symbols | 5 |
| Getting Acquainted with the Meter | 6 |
| Using the Meter | 10 |
| AC and DC Voltage Measurement..... | 10 |
| Resistance and Continuity | 11 |
| Microamps μ A Measurement | 12 |
| Temperature | 13 |
| Capacitance | 16 |
| AC Current Measurement | 16 |
| Backlight | 18 |
| MIN MAX Recording Mode | 18 |
| Display HOLD | 19 |
| Auto Off..... | 19 |
| Maintenance..... | 20 |
| Cleaning the Meter..... | 20 |
| Battery Replacement | 21 |
| Specifications | 23 |
| Electrical Specifications | 23 |
| General Specifications | 24 |

List of Tables

| Table | Title | Page |
|--------------|------------------------------------|-------------|
| 1. | 902 HVAC Clamp Meter Features..... | 7 |
| 2. | Display Features | 9 |

List of Figures

| Figure | Title | Page |
|---------------|------------------------------------|-------------|
| 1. | 902 HVAC Clamp Meter Features..... | 6 |
| 2. | Display Features | 8 |
| 3. | Testing a Flame Rod | 13 |
| 4. | Temperature Measurement..... | 15 |
| 5. | Proper AC Current Measurement..... | 17 |
| 6. | Battery Replacement..... | 22 |

Introduction

The Fluke 902 is a hand-held battery-operated HVAC Clamp Meter (“the Meter”) that measures:

- AC current
- DC current (up to 200 μ A for flame rod testing)
- AC and DC voltages
- Capacitance
- Resistance
- Continuity
- Temperature in both Celsius ($^{\circ}$ C) and Fahrenheit ($^{\circ}$ F)

The Meter comes with:

- Two AA alkaline batteries (installed)
- Users Manual
- Soft carrying case
- TL75 Test Leads (one pair)
- 80BK Integrated DMM Temperature Probe

Contacting Fluke

To contact Fluke, call one of the following telephone numbers:

USA: 1-888-99-FLUKE (1-888-993-5853)

Canada: 1-800-36-FLUKE (1-800-363-5853)

Europe: +31 402-675-200

Japan: +81-3-3434-0181

Singapore: +65-738-5655

Anywhere in the world: +1-425-446-5500

Or visit Fluke's Web site at: www.fluke.com.

Register the Meter at: <http://register.fluke.com>

Safety Information

A “**⚠️⚠️ Warning**” statement defines hazardous conditions and actions that could cause bodily harm or death.

A “**⚠️ Caution**” statement identifies conditions and actions that could damage the Meter or the equipment under test.

⚠️⚠️ Read First: Safety Information













To ensure safe operation and service of the Meter, follow these instructions:

- **Read the Users Manual before use and follow all safety instructions.**
- **Use the Meter only as specified in the Users Manual; otherwise, the Meter's safety features may be impaired.**
- **Avoid working alone so assistance can be rendered.**
- **Never use the Meter on a circuit with voltages higher than 600 V or a frequency higher than 400 Hz fundamental. The Meter may be damaged.**
- **Never measure ac current while the test leads are inserted into the input jacks.**
- **Do not use the Meter or test leads if they look damaged.**
- **Use extreme caution when working around bare conductors or bus bars. Contact with the conductor could result in electric shock.**

- **Use caution when working with voltages above 60 V dc or 30 V ac rms or 42 V ac peak. Such voltages pose a shock hazard.**
- **Clean the case with a damp cloth and mild detergent only. Do not use abrasives or solvents.**
- **To avoid false readings that can lead to electrical shock and injury, replace the batteries as soon as the low battery indicator (🔋) appears. As the Meter gets to the point where the low batteries affect the readings, the Meter locks and no measurements can be made until the batteries are changed.**
- **Do not hold the Meter anywhere beyond the tactile barrier, see Figure 1.**
- **Adhere to local and national safety codes. Individual protective equipment must be used to prevent shock and arc blast injury where hazardous live conductors are exposed.**

Symbols

The following symbols are found on the Meter or in this manual.

| | |
|---|---|
|  | May be used on hazardous live conductors |
|  | Risk of danger. Important information. See Users Manual. |
|  | Hazardous voltage. Risk of electric shock. |
|  | Double insulation |
|  | Battery |
|  | Complies with Canadian and US Standards |
|  | Conforms to relevant European Union directives |
|  | Earth ground |
|  | DC (Direct Current) |
|  | AC (Alternating Current) |
|  | Do not dispose of this product as unsorted municipal waste. Contact Fluke or a qualified recycler for disposal. |
|  N10140 | Conforms to relevant Australian standards |
|  | Inspected and licensed by TÜV Product Services |

Getting Acquainted with the Meter

Refer to Figures 1 and 2 and Tables 1 and 2 to become more acquainted with the Meter's features.

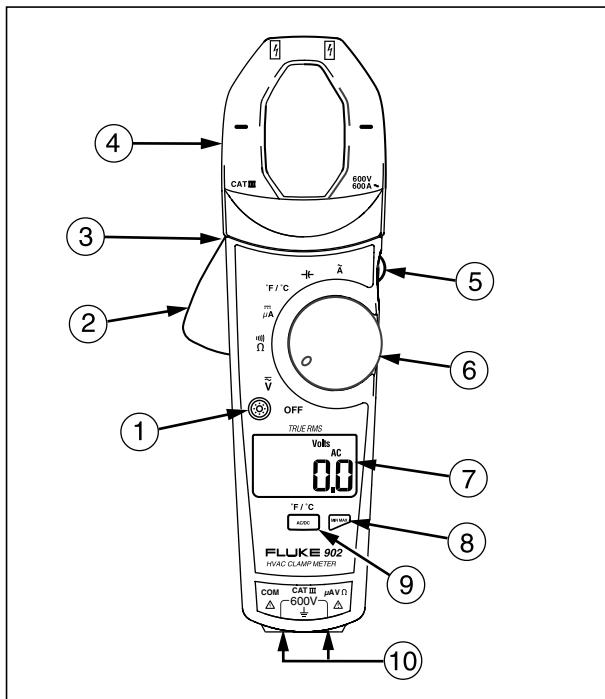

efu0001.eps

Figure 1. 902 HVAC Clamp Meter Features

Table 1. 902 HVAC Clamp Meter Features

| Number | Description |
|---------------|---|
| ① | Backlight Button |
| ② | Jaw Release |
| ③ | Tactile Barrier |
| ④ | Jaws |
| ⑤ | Hold Button |
| ⑥ | Rotary Switch: \bar{V} DC and AC voltage Ω Resistance and continuity $\bar{\mu A}$ DC microamps $^{\circ}F/^{\circ}C$ Degrees Fahrenheit / degrees Celsius ⎓ Capacitance \tilde{A} AC current |
| ⑦ | LCD |
| ⑧ | Min Max Button |
| ⑨ | AC/DC, $^{\circ}F/^{\circ}C$ Button |
| ⑩ | Input Terminals |

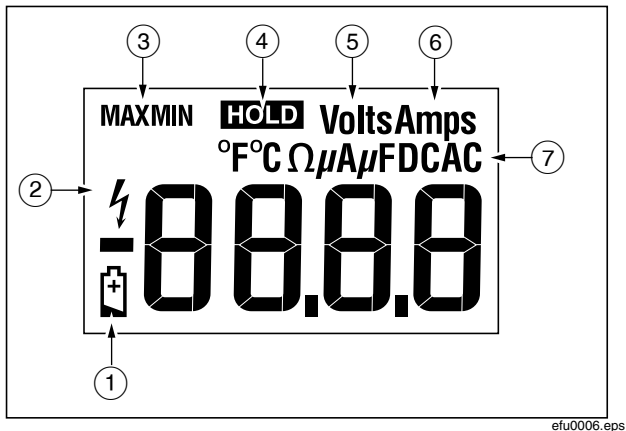

Figure 2. Display Features

Table 2. Display Features

| Number | Indication |
|--------|---|
| ① | Battery indicator -The batteries are low and need to be changed. ⚠ ⚠ Warning: To avoid false readings, which could lead to possible electric shock or personal injury, replace the batteries as soon as the battery indicator appears. |
| ② | Indicates the presence of high voltage |
| ③ | Indicators for minimum and maximum recording mode |
| ④ | Display Hold is active |
| ⑤ | Volts |
| ⑥ | Amps |
| ⑦ | °F - Degrees Fahrenheit °C - Degrees Celsius Ω - Ohms μA - Microamps μF - Microfarads DC - Direct Current AC - Alternating Current |

Using the Meter

AC and DC Voltage Measurement

To measure AC or DC voltage:

1. Insert the test leads into the Meter.
2. Turn the rotary switch to \tilde{V} .
3. Press to choose AC or DC voltage. The display reflects the chosen voltage mode.
4. Use the test leads to take the measurement. The Meter reading appears on the display.

Note

When a measured voltage is above 30 V, \tilde{V} appears on the display. When the voltage drops below 30 V, \tilde{V} disappears.

Resistance and Continuity

To measure resistance or continuity:

⚠ ⚠ Warning

To avoid false readings that can lead to electrical shock and injury, de-energize the circuit before taking the measurement.

1. Insert the test leads into the Meter.
2. Turn the rotary switch to Ω .
3. Take the measurement. The resistance reading appears on the display.
 - If the resistance is shorted, the Meter beeps and shows a reading $< 30 \Omega$.
 - If the resistance is open or exceeds the Meter's range, the display reads **OL**.

Microamps μA Measurement

The μA dc ($\overline{\overline{\mu\text{A}}}$) function on the Meter is primarily for HVAC flame rod testing. To test a heating system flame rod (refer to Figure 3):

1. Turn the heating unit off and locate the wire between the gas-burner controller and the flame rod.
2. Break this connection.
3. Turn the rotary switch on the Meter to $\overline{\overline{\mu\text{A}}}$.
4. Using alligator clips, connect test leads between the flame sensor probe and control-module wire.
5. Turn heating unit on and check the reading on the Meter.
6. Refer to the heating unit documentation for what the desired reading should be.

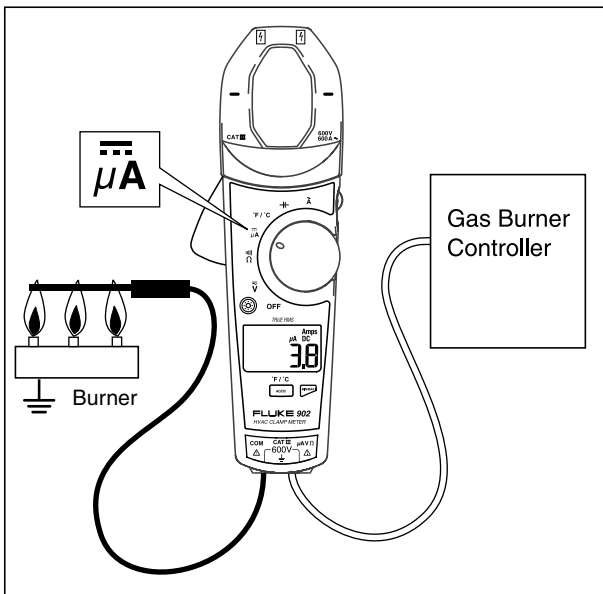

efu0004.eps

Figure 3. Testing a Flame Rod

Temperature

The Meter measures temperature in either Celsius ($^{\circ}\text{C}$) or Fahrenheit ($^{\circ}\text{F}$).

To measure temperature (refer to Figure 4):

1. Connect the 80BK Integrated DMM Temperature Probe to the input jacks noting correct polarity of the probe.
2. Turn the rotary switch to °F/°C .
3. Press  to select °C or °F. The display reflects the chosen temperature mode.
4. Position the probe to take the measurement. The reading appears on the display.

Note

To meet stated accuracy, the 80BK and Meter must be at the same temperature.

  Warning

To avoid possible electric shock DO NOT apply the probe tip to any conductor that is greater than 30 V ac, 42 V peak or 60 V dc to earth.

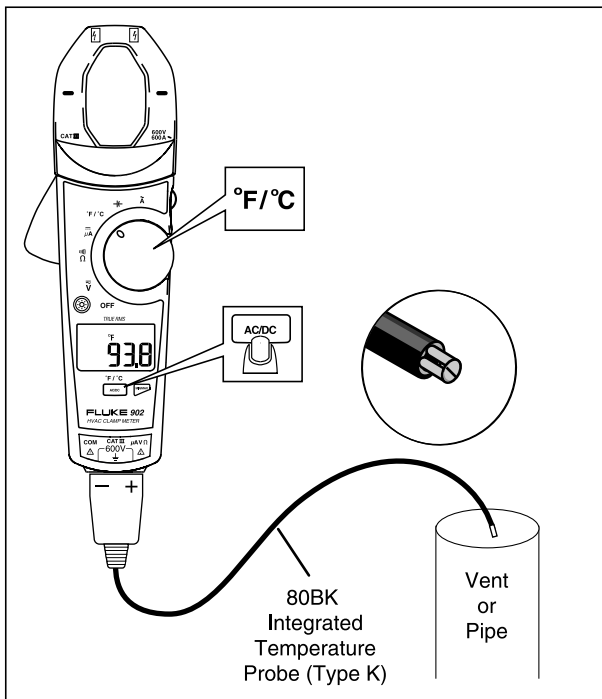

efu0005.eps

Figure 4. Temperature Measurement

Capacitance

Turn off circuit power, then disconnect and discharge the capacitor before measuring capacitance. Turn the Meter's rotary switch to capacitance (⌚).

If the capacitor requires more discharging, **diSC** is displayed while the capacitor discharges. When measuring, be sure to note the correct polarity of the capacitor.

AC Current Measurement

Warning

To avoid electrical shock and injury:

- **Remove Test Leads before making current measurements.**
- **Do not hold the Meter anywhere beyond the tactile barrier, see Figure 1.**

Turn the rotary switch to AC current (⌚). When measuring AC current, it is necessary that the measured wire be properly seated within the clamp jaws. The wire being measured should be centered within the jaws, below the horizontal line located on the clamp. Also note that currents moving in different directions will cancel each other out, so one wire must be measured at a time for a correct measurement (see Figure 5).

HVAC Clamp Meter Using the Meter

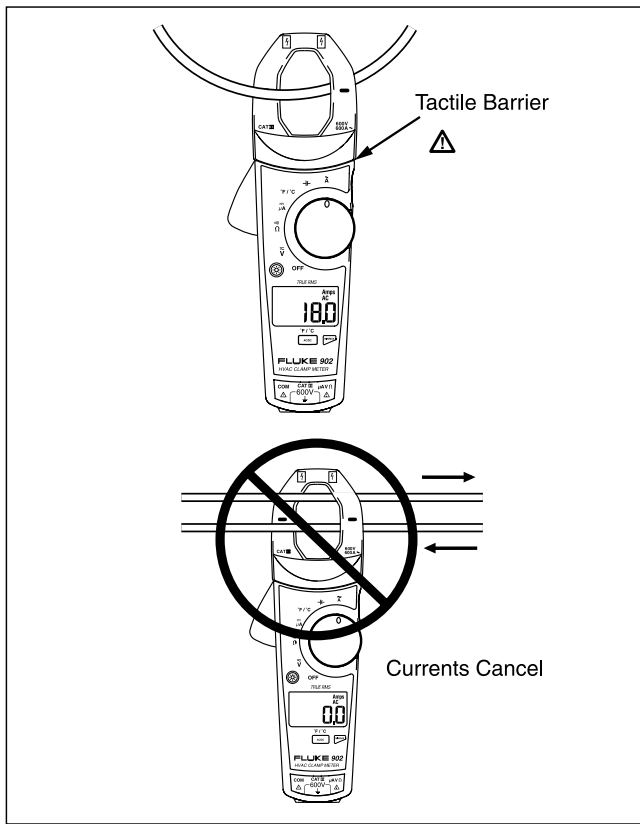

efu0003.eps

Figure 5. Proper AC Current Measurement

Backlight





Press  to toggle the backlight on and off. The backlight automatically turns off after 2 minutes.

To disable the automatic 2-minute backlight timeout, hold down  while turning the Meter on.

MIN MAX Recording Mode

The MIN MAX recording mode captures the minimum and maximum input values. When a new high or low is detected, the Meter beeps.

To use this feature:

1. Put the Meter into the desired measurement function and range.
2. Press  to enter MIN MAX Mode. **MAX** is displayed and the highest reading detected since entering MIN MAX is displayed.
3. Press  to step through the minimum (**MIN**) and present readings.
4. To pause MIN MAX recording without erasing stored values, press . **HOLD** is displayed.
5. To resume MIN MAX recording, press  again.
6. To exit and erase stored readings, press  for at least two seconds.

Display HOLD

Warning

To avoid possible electric shock or personal injury, when Display HOLD is activated, be aware that the display will not change when you apply a different voltage.

In the Display HOLD mode, the Meter freezes the display. The Meter also beeps every 4 seconds and **HOLD** flashes to remind the user.

Press  to activate Display HOLD; **HOLD** is displayed and the reading is captured.

To exit and return to normal operation, press .

Auto Off

The Meter automatically turns off after 20 minutes. The rotary switch must be turned to “**OFF**” and then turned back on for the Meter to restart. Auto Off is disabled during Min Max mode. To disable Auto Off, hold  when turning the Meter on.

Maintenance

⚠ ⚠ Warning

To avoid possible electric shock or personal injury, repairs or servicing not covered in this manual should be performed only by qualified personnel.

Cleaning the Meter

⚠ ⚠ Warning

To avoid electrical shock, remove any input signals before cleaning.

⚠ Caution

To avoid damaging the Meter, do not use aromatic hydrocarbons or chlorinated solvents for cleaning. These solutions will react with the plastics used in the Meter.

Clean the instrument case with a damp cloth and mild detergent.

Battery Replacement

⚠ ⚠ Warning

To avoid false readings that could lead to possible electric shock or personal injury, replace the batteries as soon as the low battery indicator (🔋) appears.

Disconnect the test leads before replacing the batteries.

To replace the batteries (refer to Figure 6):

1. Turn the rotary switch to “**OFF**” and remove the test leads from the terminals.
2. Use a Phillips screwdriver to loosen the battery compartment door screw, and remove the door from the case bottom.
3. Remove the batteries.
4. Replace the batteries with two new AA batteries.
5. Reattach the battery compartment door to the case bottom and tighten the screw.

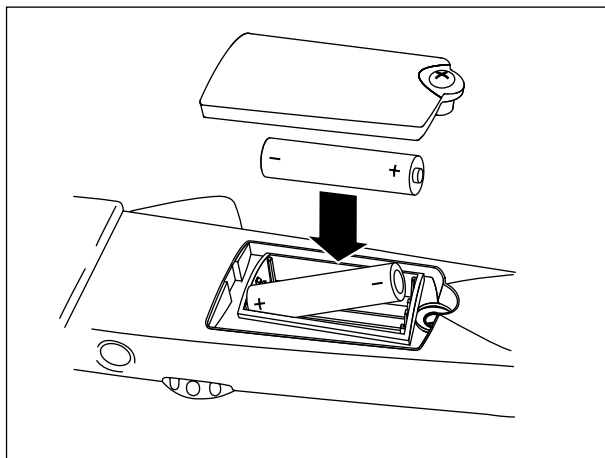

efu0002.eps

Figure 6. Battery Replacement

Specifications





Electrical Specifications

| Function | Range | Resolution | Accuracy |
|--------------------------|---------------------------------------|------------------------------|--------------------------------|
| Voltage DC | 0 – 600 V | 0.1 V | 1 % ± 5 counts |
| Voltage AC (True Rms) | 0 – 600 V | 0.1 V | 1 % ± 5 counts (50/60 Hz) |
| Current AC (True Rms) | 0 – 600 A | 0.1 A | 2.0 % ± 5 counts (50/60 Hz) |
| Current DC | 0 - 200 μ A | 0.1 μ A | 1.0 % ± 5 counts |
| Resistance | 0 – 999 Ω 0 – 9999 Ω | 0.1 Ω 1.0 Ω | 1.5 % ± 5 counts |
| Continuity | < 30 Ω | | |
| Temperature | -10 to 400 °C | 0.1 °C | 1 % ± 0.8 °C |
| Capacitance | 1-100 μ F 100-1000 μ F | 0.1 μ F 1 μ F | 1.9 % ± 2 counts |

General Specifications

| | |
|---------------------------------|--|
| Operating Temperature | -10 °C to +50 °C |
| Storage Temperature | -40 °C to +60 °C |
| Operating Humidity | Non condensing (< 10 °C) 90 % RH (10 °C to 30 °C) 75 % RH (30 °C to 40 °C) 45 % RH (40 °C to 50 °C) (Without Condensation) |
| Operating Altitude | 2500 meters above mean sea level |
| Storage Altitude | 12,000 meters above mean sea level |
| IP Rating | IP 30 per IEC 60529 |
| Vibration Requirements | MIL-PRF-28800F Class 2 random vibration |
| EMI, RFI, EMC | EMI: instrument unspecified for use in EMC field • 0.5 V / Meter EMC: Meets all applicable requirements in EN61326-1 |
| Temperature Coefficients | 0.1 x (specified accuracy)/ °C (<18 °C or >28 °C) |

HVAC Clamp Meter Specifications

| | |
|--|---|
| Size (H X W X L) | 9.1 x 3.8 x 1.7 inches (240 x 80 x 40 mm) |
| Weight | 1.1 lb (310 g) |
| Design Standards and Compliance | IEC 61010, IEC 61010-2-032,CE |
| Agency Approvals |     N10140 |
| Over-voltage Category | 600 V, CAT III per IEC 1010-1 CAT III equipment is designed to protect against transients in equipment in fixed-equipment installations, such as distribution panels, feeders and short branch circuits, and lighting systems in large buildings. |
| Power Requirements | Two AA Batteries, NEDA 15 A, IEC LR6 |

