



Bluetooth Thermal Label Printer

User Manual

PL80E

Recommended: Watch the short setup video at:

<https://www.POLONO.com/pages/driver-user-manual>

Table of contents

1. SAFETY PRECAUTIONS	01
2. PRODUCT OVERVIEW	02
3. QUICK START GUIDE	04
4. INDICATOR LIGHT STATUS	14
5. INTRODUCTION TO THE BUTTON FUNCTIONS.....	15
6. FAQ	15
7. CARE AND MAINTENANCE	17
8. BASIC SPECIFICATIONS	18
9. WARRANTY	18
10. FCC STATEMENT	19
11. IC CAUTION	20

Thank you for choosing our product. The PL80E is a very capable printer. You can create barcodes, shipping labels, name badges, and labels of many sizes. We are committed to providing the most intelligent label solutions and the best customer service. If you have any questions or suggestions while using our products, please feel free to contact us. We place great importance on user experience and are willing to listen to our customers' feedback to optimize our products and software. Every customer's voice is the inspiration and driving force behind our development. Account registration is not required to use the app or printer, but the app does require location and storage permissions to operate correctly. Registering an account will allow you to save labels and templates on our servers. If labels or templates are lost or deleted by mistake, you can contact us by e-mail to retrieve them. Thank you again for choosing and trusting us. Now, welcome to life with intelligent labeling.

1. SAFETY PRECAUTIONS

• Statement

To ensure proper and safe use of this product and to avoid personal injury or property damage, it is important to carefully read all instructions and warning tips provided in the product manual before use.

• Warning

1. Do not disassemble this product by yourself. Improper operation may result in fire hazards. Disassembled products will not be returned or exchanged.
2. Do not use corrosive chemicals or cleaning agents to clean this product.
3. Do not use this product near flammable materials such as gas stations or fuel warehouses.

4. After printing, the print head will still be at a high temperature. Do not touch it to avoid burns.
5. Use only approved accessories; using a power adapter with a mismatched voltage may damage the printer.
6. When you notice smoke or unusual smells coming from the product or power adapter, immediately unplug the power adapter and avoid getting burned.
7. Do not bend the power cord excessively or place objects on the cord.
8. Keep the printer out of reach of children.
9. Keep the printer away from water and other fluids that could damage the components.
10. Unplug the printer when it is not in use for long periods.

2. PRODUCT OVERVIEW

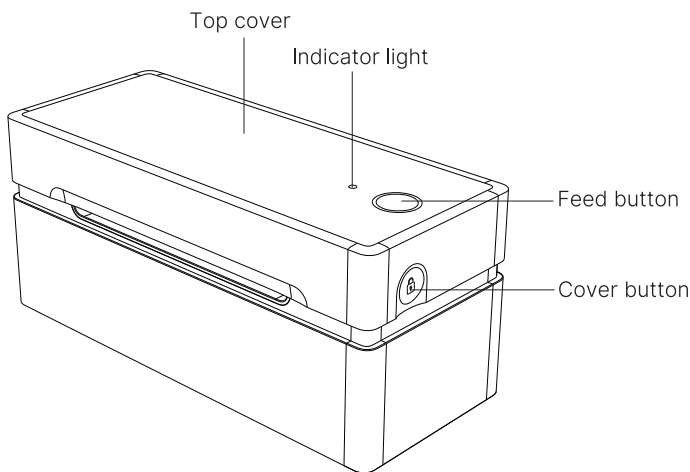

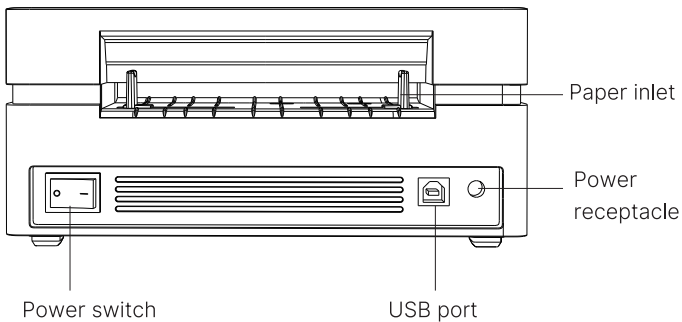

Packing list

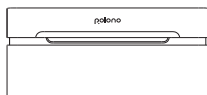

Printer

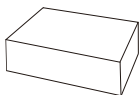

Test labels

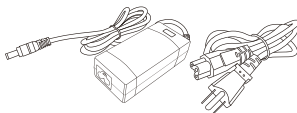

Power cable

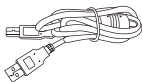

USB cable



USB-C to USB-A adapter
(for computer with only
USB-C port)



U-disk
(contains drivers
and user guide)

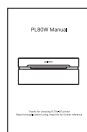

Manual

Notes

The above diagrams are to be used for reference only; parts and components may vary depending on your order.

3. QUICK START GUIDE

Printer Connection

▶▶ **Note:**

- Ensure the printer is OFF.
- Use original power adapter only in case harm or injure.
- Unplug if no use in a long time.

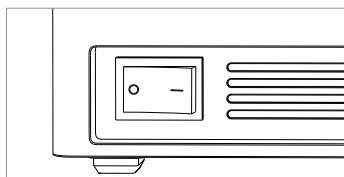
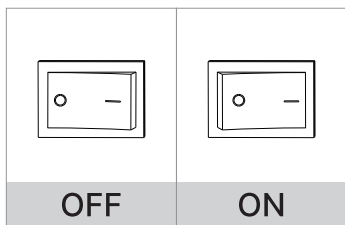

① Ensure the printer is OFF.

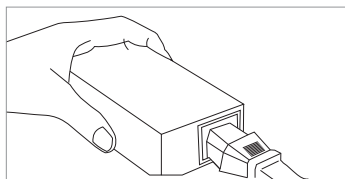

② Attach the power cord to the adapter.

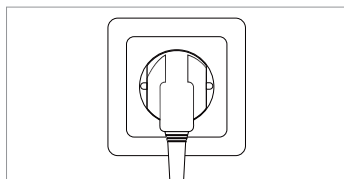

③ Plug the power cord into the socket.

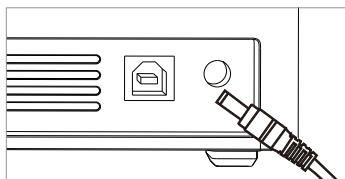

④ Connect the power cable.

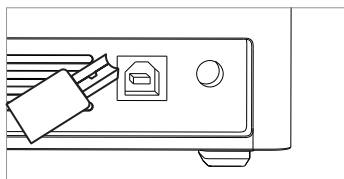

⑤ Connect the USB cable.

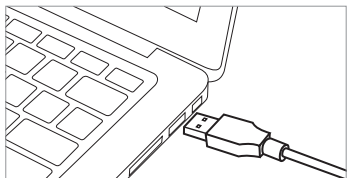

⑥ Connect the printer and computer.

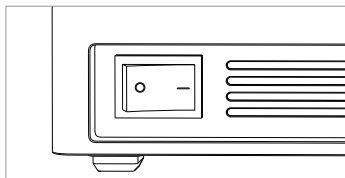

⑦ Turn the power ON.

Label Setup

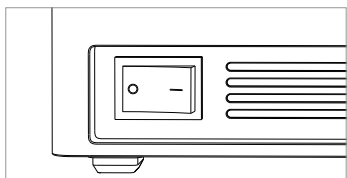

① Turn the printer OFF.

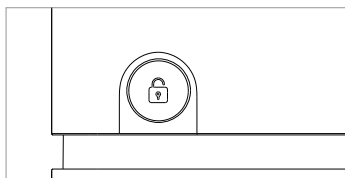

② Press the cover button to open the cover.

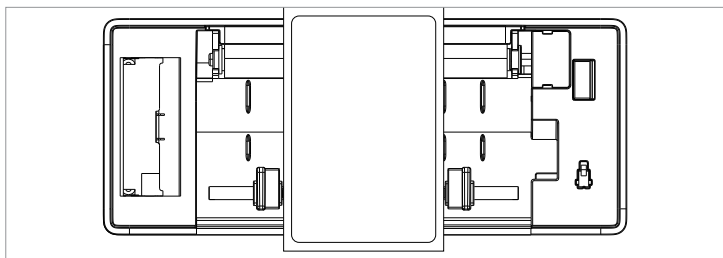

③ Load the paper with the label side up. Make sure the paper guides are flush against the paper with no gaps.

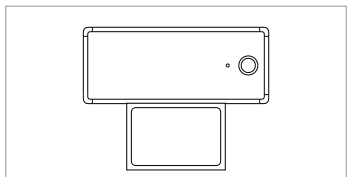

④ Carefully close the cover.

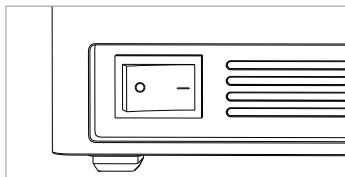

⑤ Turn the power ON and wait 5 seconds for the printer to initialize.

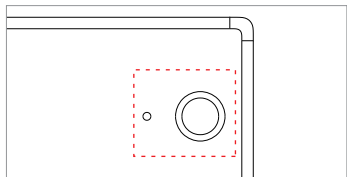

⑥ Press and hold the feed button until you hear one beep to calibrate.

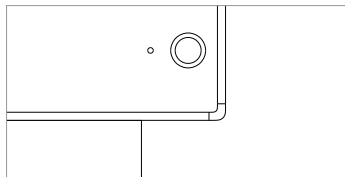

⑦ Printer is ready.

Note:

- The printer will only print to the top side of the paper; make sure the paper is installed with the label side face up to avoid printing blank sheets.
- If the paper feeds abnormally, open the cover and leave some of the paper sticking out of the printer before closing the cover.
- Avoid poor quality labels as they can damage the printer.

· Driver Installation (for computers)

· You can obtain the printer's driver file in one of the following ways:

1. A U-disk is provided in the accessory bag. Plug in the U-disk and locate the appropriate driver for your operating system in the "Driver files for installation" folder.
2. Visit the POLONO support page to download the PL80E printer driver and view related tutorial videos.

Polono support page:

<https://www.POLONO.com/pages/driver-user-manual>.

If this link does not work, navigate to POLONO.com and under the Support tab, click into "Driver & User manual".

✓ **NOTE:** Make sure the printer is powered on and connected to the computer via the USB cable before running the driver file.

✓ Do not manually add the printer to the computer; run the driver file to properly set up the printer.

✓ Plug the PL80E into the same USB port on your computer every time. This will avoid creating duplicate copies of the printer.

» Windows

Please follow the driver prompts to install

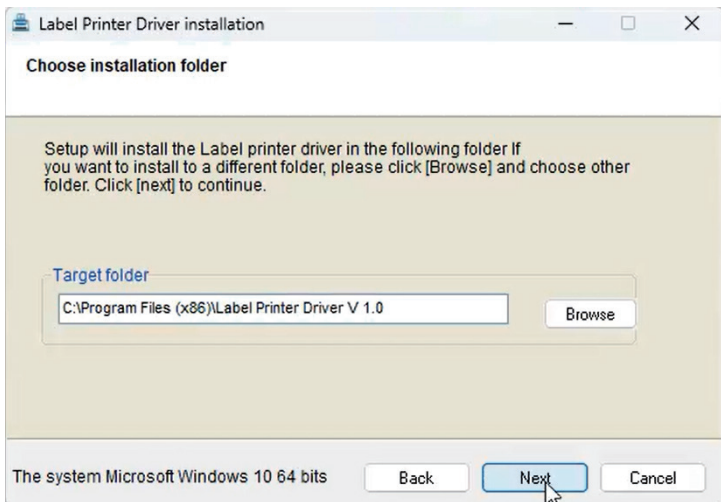

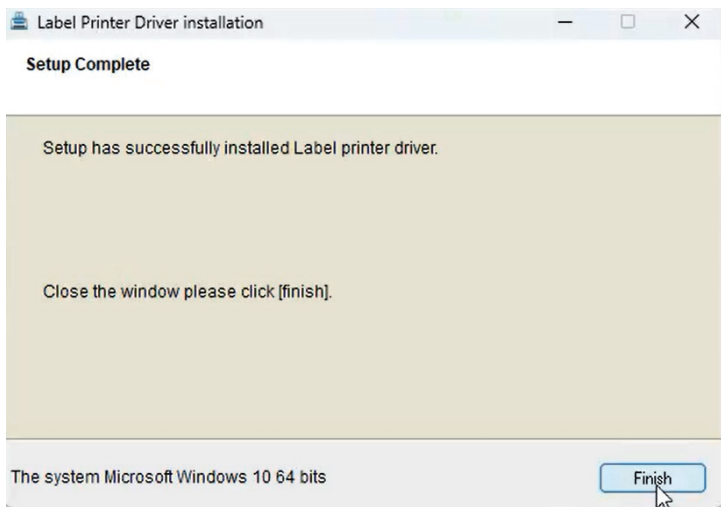
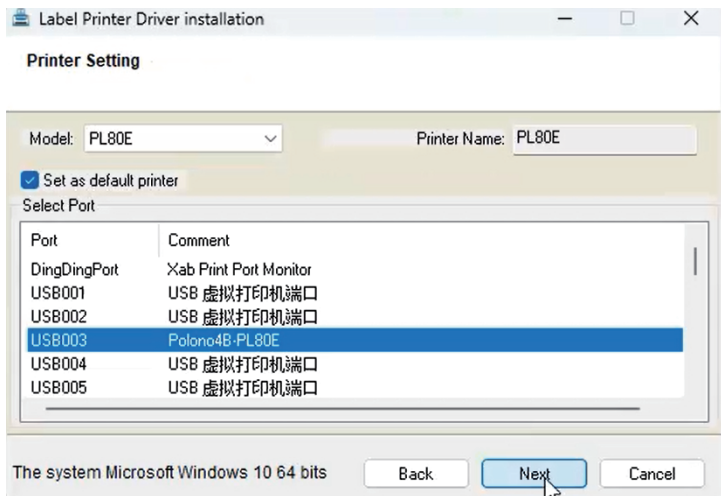

» Mac

Notes:

1. For computers that don't have a USB-A port, use the included adapter instead of a hub or docking station, which may prevent the computer from detecting the printer.
2. If it shows "The application can't be opened", go to "System Settings" - "Privacy & Security", slide down and click on "Open Anyway".

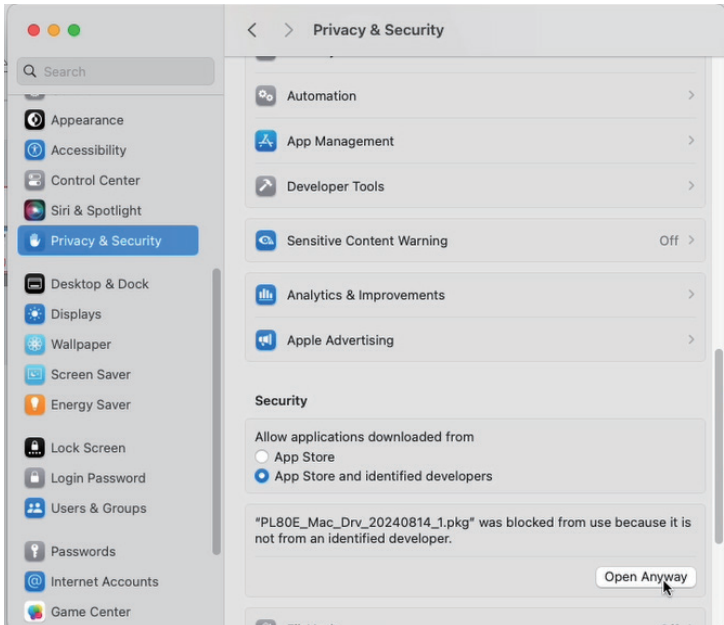
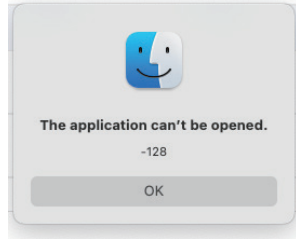
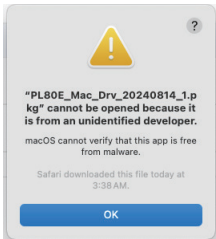

Please follow the driver prompts to install

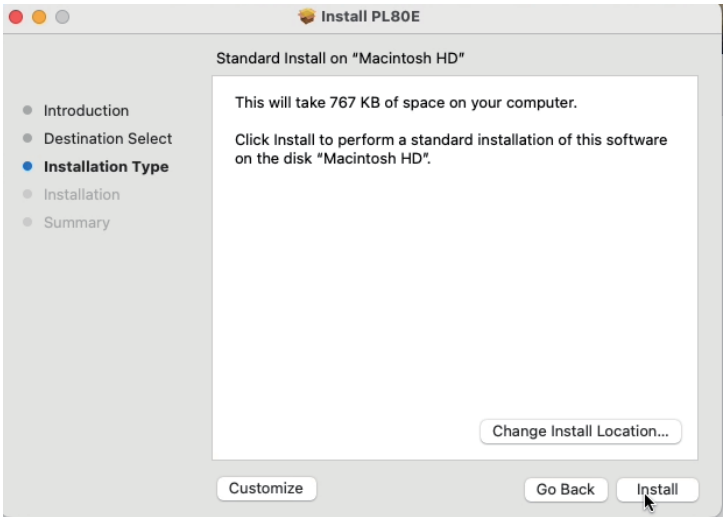
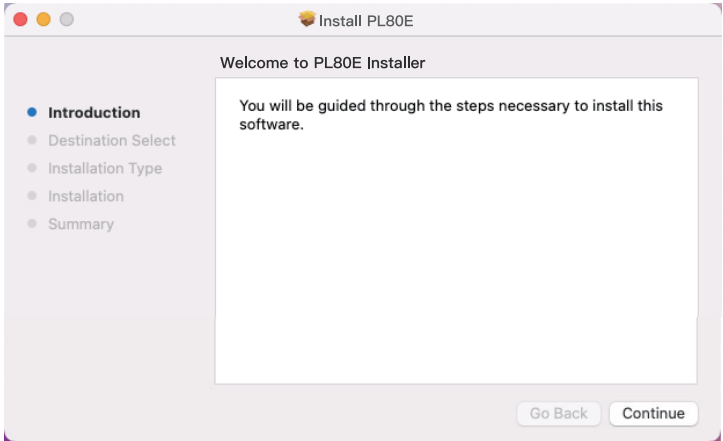

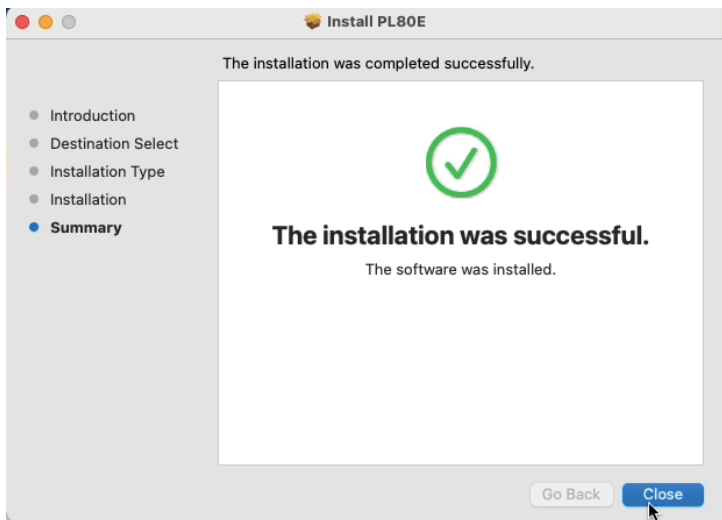

• Changing the Printer Settings on Windows

1. Access the Printing preferences

From the Control Panel, click into "View devices and printers," right click on the PL80E, and select "Printing preferences."

Alternatively, from the Settings, click into Devices, and then Printers & scanners. Select PL80E and click Manage to find the Printing preferences.

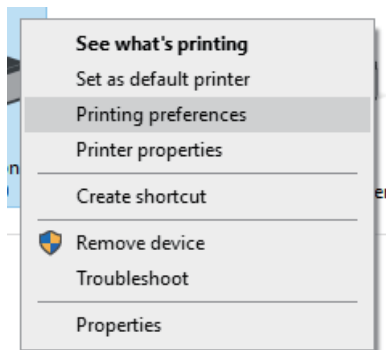

2. Change the paper settings

Select the installed paper size from the Paper drop down menu. Change any other settings and click Apply then OK when finished.

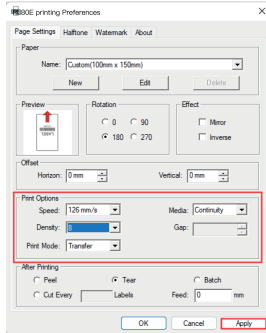

• Changing the Printer Settings on Mac

1. Add the Printer

From the System Preferences, open Printers & Scanners, and click on the “+” button to add a new printer.

Note: The printer must be added AFTER installing the driver. If the printer was added before installing the driver, remove the printer and add it back.

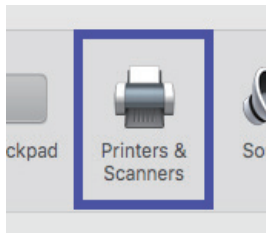

2. Select Software

Select Thermal Printer and make sure the “Use” shows “PL80E.” If it does not, open the drop down and choose “Select Software...”. Search for PL80E and click OK then Add.

Note: If PL80E does not appear in the “Use” drop down, make sure you installed the driver for Mac before proceeding.

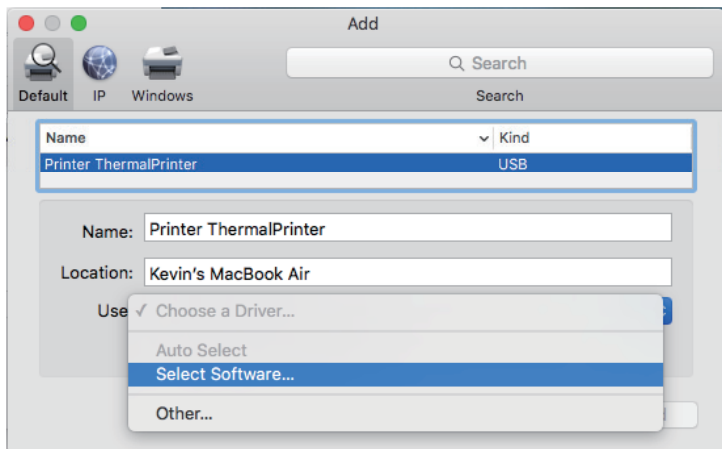

3. Set the Paper Size

When printing, make sure the correct Paper Size is selected. Choose the size that matches the installed paper. If you are using the included test labels, the size is 4 x 6 or 100 mm x 150 mm.

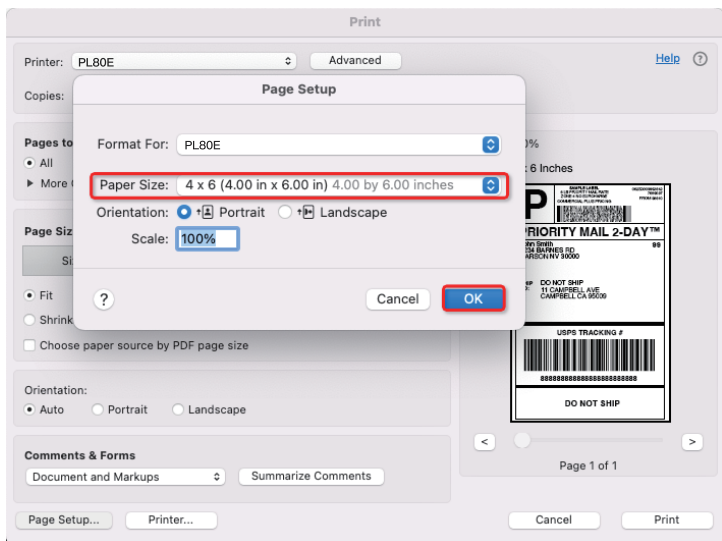

• PRINTING VIA PHONE

Search for [Labelnize] on Google Play or App Store and Install. Turn on Bluetooth, search for the printermodel-PL80E in [Labelnize], open a blank label to create your own label or use the templates in the app to print labels.



4. INDICATOR LIGHT STATUS

Indicator light	Action	Status	Troubleshoot
Green	Solid	The printer is powered on and ready	/
Green	Flashing	Firmware upgrade	/
Blue	Solid	Bluetooth is connected	/
Blue	Flashing	Bluetooth is not connected	/
Red	Solid	Cover is open or paper is not loaded correctly	Check that the cover is completely closed and that the printer paper is loaded correctly
Red	Flashing quickly	Print head has overheated	Printer will automatically resume once the print head has cooled down
Red	Flashing slowly	Paper recognition abnormality	Calibrate the printer by holding the Feed button until you hear a beep

5. INTRODUCTION TO THE BUTTON FUNCTIONS

Function	Operation
Power on / off	Turn on / off the “Power switch”
Feed a sheet of paper	Press the “Feed button” once
Calibrate the paper	Hold the “Feed button” and release when you hear one beep
Pause printing	While printing, press the “Feed button” to pause; press once more to resume.
Print the self-test page	Hold the “Feed button” and release when you hear two beeps
Reset	Hold the “Feed button” and release when you hear three beeps

6. FAQ

Links for PL80E troubleshooting:

<https://www.polono.com/pages/support-troubleshooting>

- ① **Question:** Do I need to register to use the printer?
Answer: Registration is not necessary. Registered accounts are able to save and retrieve label templates from our servers.
- ② **Question:** Why is the printer printing blank labels?
Answer: The most common reason is the label paper is installed incorrectly. Make sure the label side faces up.
- ③ **Question:** Why does the printer continuously feed labels?
Answer:
 - (1) There is residue or debris on the sensors or print head. Open the paper bin cover and clean the sensors and print head with rubbing alcohol.
 - (2) It may be caused by the machine not being able to recognize the label gap. Reinstall the paper and press and hold the “Feed button” until you hear a beep sound to calibrate the printer.

- ④ **Question:** Why does the printout look gray or faded?
Answer: Use genuine label paper for best results. If the issue persists, try cleaning the print head with rubbing alcohol.
- ⑤ **Question:** Why does the printer skip a label or print incomplete?
Answer:
(1) Check if the document size, paper size (through computer or app) and paper label size (installed paper) match.
(2) Reinstall the paper and press and hold the “Feed button” until you hear a beep sound to calibrate the printer.
- ⑥ **Question:** Why did the printer suddenly stop printing?
Answer: Certain safety measures are in place. The most common reasons are the printer has activated overheating protection or the printer is out of paper.
- ⑦ **Question:** I have installed the driver, but why am I still unable to print from my computer?
Answer: (1) The printer needs to be powered on and connected to the computer via the USB cable or wireless Bluetooth prior to installing the driver. Uninstall then reinstall the printer driver.
(2) You can check whether the computer recognizes the USB printing support of the printer through the device manager, and the specific operation tutorial can be viewed by clicking the link below:
<https://www.polono.com/pages/the-computer-does-not-recognize-the-pl80e-printer-usb>
- ⑧ **Question:** How do I set or change the paper size or print darkness?
Answer:
Windows - Go to Settings – Devices - Printers & scanners - Label printer - Manage, click on Printing preferences. Adjust the paper size and print density.
Mac - Open any PDF file, click on Page Setup, then click on Paper Size to select or manage the paper size.
Labelnize App – Select the label paper size when editing a document and select the density on the Print Settings page.

7. CARE AND MAINTENANCE

Cleaning of print head and rubber rollers

· When any of the following situations occur during printing, the print head and rubber rollers should be cleaned:

- Unclear printing;
- Loud noise during paper feeding or paper return;
- Debris stuck on the print head.

· The steps for cleaning the print head and rubber rollers are as follows:

- ① Power off the printer;
- ② Open the cover and locate the print head (as shown in the figure). If the printer was just used to print, wait for the print head to cool completely;
- ③ While rotating the roller, use a cotton ball with some rubbing alcohol on it to wipe off any dust or debris;
- ④ Use a cotton ball with some rubbing alcohol on it to wipe off any dust or debris on the print head;
- ⑤ Wait for the rubbing alcohol to completely evaporate before closing the cover.

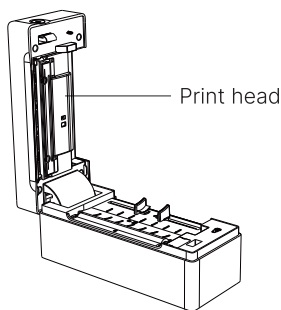

Note:

- The printer must be powered off while cleaning.
- Avoid touching the surface of the print head with your hands or metal objects, and do not use tweezers or other tools to scratch the surface of the print head, rubber rollers, or sensors.
- Do not use organic solvents such as gasoline or acetone to

wipe the print head or roller.

- Wait for the rubbing alcohol to completely evaporate before turning on the power and continuing to print.
- Keep the sensor surface clean.

8. BASIC SPECIFICATIONS

Model	PL80E
Printing method	Thermal
Resolution	203dpi
Supported print widths	25,4mm-108mm
Printing speed	50mm / s-150mm / s
Connection	USB, Bluetooth
USB connection support system	Windows, Mac
Bluetooth connection support system	Android, iOS, iPad, Windows
Operating environment	5°C-45°C (41°F-113°F) No condensation
Storage environment	-20°C-60°C (-4°F-140°F) No condensation
Paper cutting	Tear paper
Input	DC 24V 2.5A
Product size	201mm × 83mm × 93mm

9. Warranty

We offers an extensive warranty for all products that extends through 1 YEAR of the order date. This warranty covers quality related issues and product defects.

If you are past the 30-day return period on Amazon, contact us directly via the “Contact seller” option on your Order Details. If the product is not working properly, we can send you a

replacement product. This warranty does not apply in cases of abuse, mishandling, or unauthorized repair of the product. If you have any question about this warranty or would like additional information, please contact us via the “Contact Seller” option or directly via e-mail (support@polono.com).

Please keep the original box, packing materials and all documentation in the event that service is required.

Extended Warranty

Please contact support@polono.com to extend the warranty to 3 years with your order No.

10. FCC Statement

This device complies with part 15 of the FCC Rules. Operation is subject to the following two conditions: (1) this device may not cause harmful interference, and (2) this device must accept any interference received, including interference that may cause undesired operation. Any changes or modifications not expressly approved by the party responsible for compliance could void the user’s authority to operate the equipment.

NOTE: This equipment has been tested and found to comply with the limits for a Class B digital device, pursuant to Part 15 of the FCC Rules. These limits are designed to provide reasonable protection against harmful interference in a residential installation. This equipment generates, uses and can radiate radio frequency energy and, if not installed and used in accordance with the instructions, may cause harmful interference to radio communications.

However, there is no guarantee that interference will not occur in a particular installation.

If this equipment does cause harmful interference to radio or television reception, which can be determined by turning the equipment off and on, the user is encouraged to try to correct the interference by one or more of the following measures:

- Reorient or relocate the receiving antenna.
- Increase the separation between the equipment and receiver.
- Connect the equipment into an outlet on a circuit different from that to which the receiver is connected.
- Consult the dealer or an experienced radio / TV technician for help.

To maintain compliance with FCC's RF Exposure guidelines, This equipment should be installed and operated with minimum 20cm distance between the radiator and your body: Use only the supplied antenna.

11. IC Caution

English:

This device complies with Industry Canada licence–exempt RSS standard (s). Operation is subject to the following two conditions:
 (1) This device may not cause interference, and
 (2) This device must accept any interference, including interference that may cause undesired operation of the device.

To maintain compliance with RSS–102 RF Exposure guidelines, This equipment should be installed and operated with minimum 20cm distance between the radiator and your body: Use only the supplied antenna.

French:

Le présent appareil est conforme aux CNR d'Industrie Canada applicables aux appareils radio exempts de licence.

L'exploitation est autorisée aux deux conditions suivantes:

- (1) l'appareil ne doit pas produire de brouillage, et
 - (2) l'utilisateur de l'appareil doit accepter tout brouillage radioélectrique subi, même si le brouillage est susceptible d'en compromettre le fonctionnement.
- Pour être conforme aux lignes directrices d'exposition RF RSS–102, cet équipement doit être installé et exploité à une distance minimale de 20cm entre le radiateur et votre corps: n'utilisez que l'antenne fournie.