

Marvel and Marvel Professional

Under Counter Product

Service Manual

**Beverage Centers - Wine Cellars - All Refrigerators -
Refrigerated Drawers - Refrigerator Freezers - Beer
Dispensers - Outdoor Models - Clear Ice Machines**

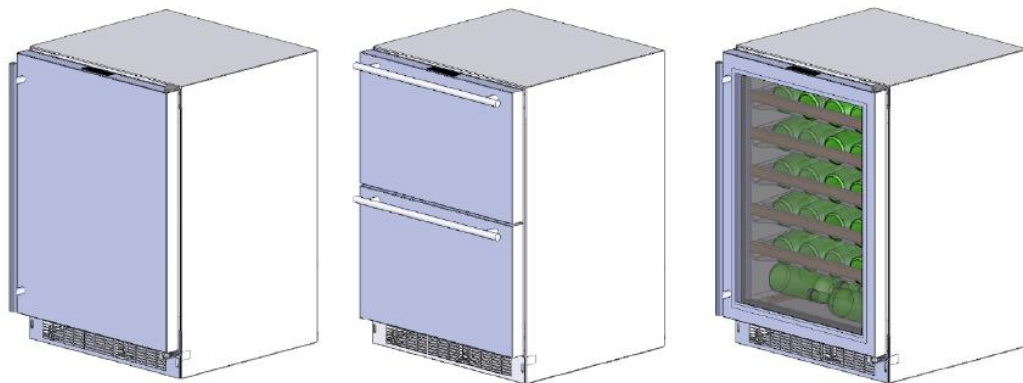

AGA MARVEL

Second Edition

41013818-Rev B; August 2015

Table of contents

Section 1: Introduction

- 1.1 Unit Specifications
- 1.2 Serial Nameplate
 - 1.2.1 Serial Description
- 1.3 Servicing
- 1.4 Basic Refrigeration Tools
- 1.5 Basic Installation
- 1.6 Electrical Requirements

Section 2: Sealed System

- 2.1 Introduction
- 2.2 Low Side Leaks
- 2.3 High Side Leaks
- 2.4 Restricted Capillary Tube
- 2.5 Access Valves
- 2.6 Evaporator Frost Pattern
- 2.7 Measuring Evaporator Temperatures
- 2.8 Re-charging
- 2.9 Pressure and Temperature Chart

Section 3: Sealed System Components

- 3.1 Toe Grille Removal
- 3.2 Warning and Cautions
- 3.3 Accessing the Machine Compartment
- 3.4 Compressor
 - 3.4.1 Check Compressor Winding Resistance
 - 3.4.2 Compressor Removal
 - 3.4.3 Compressor Installation
- 3.5 Condenser
 - 3.5.1 Condenser Removal
 - 3.5.2 Condenser Installation
- 3.6 Evaporator
 - 3.6.1 Evaporator Removal
 - 3.6.2 Evaporator Installation

Section 4: Electrical Component Access

- 4.1 Condenser Fan
 - 4.1.1 Fan Assembly Removal
 - 4.1.2 Fan Assembly Replacement
 - 4.1.3 Fan Motor Installation
 - 4.1.4 Condenser Fan Blade Spacing
- 4.2 Evaporator Fan Access
- 4.3 Thermistor Locations

Section 5: User Interface Display

- 5.1 Model Variations
- 5.2 User Interface Navigation: Beverage Center
- 5.3 User Interface Navigation: Wine Coolers
- 5.4 User Interface Navigation: Refrigerated Drawers
- 5.5 User Interface Navigation: Beer Dispensers

Section 6: Control System

- 6.1 User Interface Assembly
 - 6.1.1 Removing the User Interface
 - 6.1.2 Installing a Replacement Interface
- 6.2 Main Control Board Assembly
 - 6.2.1 Main Control Replacement
 - 6.2.2 Removing the Programming Data Cable
 - 6.2.3 Replacing the Programming Data Cable
 - 6.2.4 Main Control Board Installation
- 6.3 Cabinet and Defrost Thermistors
 - 6.3.1 Thermistor (Sensor)
 - 6.3.2 Check the Thermistor
 - 6.3.3 Removing the Cabinet Thermistor
 - 6.3.4 Installing the Cabinet Thermistor
 - 6.3.5 Removing the Defrost Thermistor
 - 6.3.6 Installing the Defrost Thermistor
 - 6.3.7 Thermistor Harness Identification
- 6.4 Temperature Resistance Chart
- 6.5 Door Sensor
 - 6.5.1 Door Sensor Removal
 - 6.5.2 Door Sensor Replacement
- 6.6 Defrost Modes
 - 6.6.1 Defrost Characteristics
 - 6.6.2 Auto Defrost
 - 6.6.3 Manual Defrost
- 6.7 Error Codes

Section 7: Lights, Doors, Drawer, & Hinges

- 7.1 LED Lights
 - 7.1.1 LED Light Replacement
- 7.2 Cabinet Door
 - 7.2.1 Door Removal
 - 7.2.1.1 Marvel & non Overlay Models (standard hinge)
 - 7.2.1.2 Marvel Pro and Overlay Models (articulating hinge)
 - 7.2.2 Bottom Door Closer
- 7.3 Refrigerated Drawers
 - 7.3.1 Drawer Removal
- 7.4 Door and Drawer Handle Adjust
- 7.5 Door Alignment and Adjust
- 7.6 Door and Drawer Gasket Adjust and Replace
- 7.7 Articulating Hinges

Section 8: Evaporator Compartment Access

- 8.1 Beverage Centers
- 8.2 Wine Coolers
- 8.3 Refrigerated Drawers
- 8.4 Evaporator Cover Drip Edge

Section 9: Wiring Diagrams

- 9.1 Block Diagram
- 9.2 Wiring Schematics - All
- 9.3 Main Power Board Identification
 - 9.3.1 Single Zone
 - 9.3.2 Dual Zone

Section 10: Power on Reset Mode

- 10.1 Auto Self-Test
- 10.2 Manual Auto Test
- 10.3 Control Types
 - 10.3.1 Single Zone
 - 10.3.2 Dual Zone

Section 11: Quick Reference Troubleshooting

Section 12: Diagnostic Flow Charts

- 12.1 Does Not Run
- 12.2 Too Cold
- 12.3 Not Cooling
- 12.4 Runs Continuously
- 12.5 Excessive Noise
- 12.6 LED Lighting

Section 13: Gathering Service Data

- 13.1 Program Port
 - 13.1.1 Service Data Retrieval
 - 13.1.2 Service Data Port Location
 - 13.1.3 Onboard Diagnostics

Section 14: Beer Dispenser

- 14.1 Internal / External Components
- 14.2 Main Control Board Access
- 14.3 Machine Compartment
 - 14.3.1 Refrigeration and Mechanical
- 14.4 Excerpts from Owners Maintenance Guide

Section 15: Dual Zones

- 15.1 User Interface Control
- 15.2 Operation
- 15.3 Characteristics
- 15.4 Compartment Air Flow
- 15.5 Damper Removal
- 15.6 Damper Operation
- 15.7 Compartment Fan Operation
- 15.8 Heater Operation
- 15.9 Thermistors
- 15.10 Evaporator Access
- 15.11 Interior LEDs
- 15.12 Defrost – Drip Time
 - 15.12.1 Defrost Sequence
- 15.13 Refrigeration & Mechanical

Section 16: Refrigerator Freezers

- 16.1 User Interface Control
- 16.2 Operation
- 16.3 Characteristics
- 16.4 Damper Operation
 - 16.4.1 Damper Access
- 16.5 Fan Operation
 - 16.5.1 Refrigerator Supply Air
 - 16.5.2 Freezer Supply Air
- 16.6 Thermistors
 - 16.6.1 Thermistor Type
 - 16.6.2 Thermistor Location
- 16.7 Refrigeration and Mechanical
- 16.8 Evaporator
 - 16.8.1 Evaporator Type
 - 16.8.2 Evaporator Location
- 16.9 Defrost
 - 16.9.1 Defrost Function
 - 16.9.2 Defrost Heater
 - 16.9.3 Defrost Thermistor
 - 16.9.4 Defrost Termination Thermostat
 - 16.9.5 Defrost Drip Time
- 16.10 Access to Defrost Components
 - 16.10.1 Defrost Heater
 - 16.10.2 Defrost Termination Thermostat
 - 16.10.3 Defrost Thermistor
- 16.11 RFI (Refrigerator Freezer with Ice Maker)
 - 16.11.1 Ice Maker
 - 16.11.1.1 Ice Maker Specs
 - 16.11.1.2 Ice Maker Test Cycling
 - 16.11.1.3 Water Flow Volume
 - 16.11.2 Ice Maker Removal
 - 16.11.3 Ice Maker Kit
 - 16.11.3.1 Ice Maker Kit Installation Instructions
 - 16.11.3.2 Installation Schematic

Section 17: Outdoor Models

- 17.1 Operation
- 17.2 Characteristics
- 17.3 Fan Operation
- 17.4 Thermistors
- 17.5 Control Type
- 17.6 Control Features
- 17.7 Control Locations by Model
 - 17.7.1 Beverage Centers and Dispensers: 6 cu. ft.
 - 17.7.2 Beverage Center: 3 cu. ft.
 - 17.7.3 Refrigerated Drawers
- 17.8 Machine Compartment
- 17.9 Main Power Board Access
- 17.10 Display Access and Replacement
 - 17.10.1 Beverage Center: 3 cu. ft.
 - 17.10.2 Beverage Centers and Dispensers: 6 cu. ft.

17.10.3 Refrigerated Drawers: 6 cu. ft.
17.11 Thermistor Resistance Chart
17.12 Wiring Diagram
17.13 Generic Troubleshooting Table
17.13.1 Refrigerated Drawers
17.13.2 Beverage Centers and Dispensers
17.14 Refrigeration and Mechanical

Section 18: Prime Control

18.1 Control Type
18.2 Control Functions
18.3 Fan Operation
18.4 Thermistors
18.5 Machine Compartment
18.6 Thermistor Resistance
18.7 Wiring Diagram
18.8 Generic Troubleshooting Table
18.9 Refrigeration and Mechanical

Section 19: Clear Ice Machines

19.1 Control Operations
19.2 Control System
19.3 Interior Features
19.4 Machine Compartment
19.5 Diagnostic Test Mode

19.6 Diagnostic Charts
19.7 Troubleshooting
19.8 VAC Wiring Diagram
19.9 Specifications
19.10 Ice Production & Harvest Guidelines

Section 20: Service Kits/Bulletins

20.1 Refrigerated Drawer – Mullion Heater Kit
20.2 Evaporator Replacement Kit (also refer to section 3.6)
20.3 Door Sensor and Spacer Installation
20.4. Slotted Condenser Shroud
20.5 Showroom Mode Alarm
20.6 Evaporator and Heat Exchanger Replacement (RF and RFI Models Only)
20.7 Shelf Shim Kit (Non-Professional Models)
20.8 Miscellaneous Control Communication Errors
20.9 Door Skin Replacement on MP Models

Section 21: Customer Service Contact Information

Section 22: Notes

- Blank Pages Added

At the time of the release of this manual; all information, parts, and procedures were current. AGA Marvel reserves the right to make continual changes with the product to strive for continuous improvement.

For product updates, revised literature, or related service bulletins please visit our customer service website www.marvelservice.com

A username and password will be needed to access this website, if you currently do not have access, please contact 1-800-223-3900.

If you would like to speak with a Customer Service representative for technical or part order assistance, call 1-800-223-3900. Please follow the phone queue to the correct department to avoid unnecessary delays.

Section 1: Introduction

1.1 Unit Specifications:

(Single Zone) WINE COOLERS, BEVERAGE CENTERS, ALL REFRIGERATORS

Performance Data: No Load & No Door Openings @ Control Setting of Mid		
Type A with Run Capacitor	65°F (18°C) Ambient	90°F (32°C) Ambient
Operating Time	8 - 15% (wine cooler) 15 - 35% (beverage center / refrigerator)	20 - 40% (wine cooler) 35 - 55% (beverage center/refrigerator)
Wine Cooler Temperature	40°F - 65°F	40°F - 65°F
Beverage Center / All Refrigerator Temperature	34°F - 42°F	34°F - 42°F
Low Side Pressure (cut in)	25 - 50 psig (172 - 345 kPa)	25 - 50 psig (172 - 345 kPa)
Low Side Pressure (cut out)	0 - 10 psig (0 - 69 kPa)	0 - 10 psig (0 - 69 kPa)
High Side Pressure (last 1/3 of cycle)	95 - 125 psig (655 - 862 kPa)	130 - 175 psig (896 - 1207 kPa)
Wattage (last 1/3 of cycle)	55 - 80	55 - 80
Amps (running)	.45 - .85	.45 - .85
Base Voltage	115 VAC (127 VAC max)	115 VAC (127 VAC max)
R-134A Charge in Ounces: 3.0		
Compressor		
120 volt/60 hertz	BTU/HR: 200	LRA: 5.22
Condenser Fan Motor		
Watts	RPM	Amps
4.1	1280	0.06
Evaporator Fan Motor		
Watts	RPM	Amps
1.08	2550	0.09

REFRIGERATED DRAWERS

Performance Data: No Load & No Door Openings @ Control Setting of Mid		
Type A with Run Capacitor	65°F (18°C) Ambient	90°F (32°C) Ambient
Operating Time	8 - 15%	20 - 40%
Temperature	34°F - 42°F	34°F - 42°F
Low Side Pressure (cut in)	25 - 50 psig (172 - 345 kPa)	25 - 50 psig (172 - 345 kPa)
Low Side Pressure (cut out)	0 - 10 psig (0 - 69 kPa)	0 - 10 psig (0 - 69 kPa)
High Side Pressure (last 1/3 of cycle)	95 - 125 psig (655 - 862 kPa)	130 - 175 psig (896 - 1207 kPa)
Wattage (last 1/3 of cycle)	55 - 80	55 - 80
Amps (running)	.45 - .85	.45 - .85
Base Voltage	115 VAC (127 VAC max)	115 VAC (127 VAC max)
R-134A Charge in Ounces: 3.0		
Compressor		
120 volt/60 hertz	BTU/HR: 200	LRA: 5.22
Condenser Fan Motor		
Watts	RPM	Amps
4.1	1280	0.06
Evaporator Fan Motor		
Watts	RPM	Amps
1.08	2550	0.09

1.2 Serial Nameplate:

The serial plate location is model dependent on the beverage centers, wine coolers and refrigerated drawer models. The serial plate is located on the inside of the cabinet affixed to the left hand side (top or bottom) of the plastic liner.

- Beverage centers and wine coolers: Upper front corner on left hand side of liner.
- Refrigerated drawers: Left hand liner bottom, front side beneath the bottom drawer.

NOTE: The model, service, and serial number will need to be given when inquiring about the unit or ordering parts.

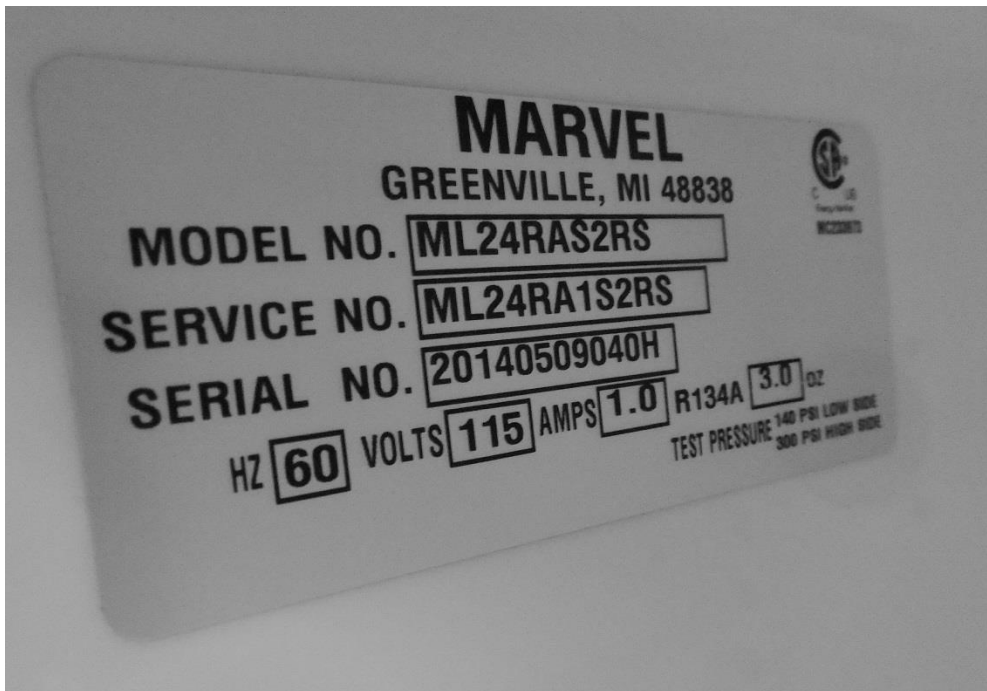

1.2.1 Serial Number Description:

EXAMPLE: 20140509040H

Breakdown of the 12 Digit Serial Number:

Read the number sequence from **left to right:**

Digit number 1 thru 4	(2014)	Year of manufacture (2014)
Digit number 5 and 6	(05)	Month of manufacture (May)
Digit number 7 and 8	(09)	Day of manufacture (09; 9)
Digit number 9 thru 11	(040)	Sequence of manufacture
Digit number 12	(H)	Manufacturing facility (Greenville)

1.3 Servicing

- Always disconnect power to any appliance before attempting to service it. Always verify that the power has been disconnected.
- If the unit has been running, use caution around the compressor, condenser and copper tubing. These areas may be very hot.
- Use caution around the condenser wires and metal edges. These areas could be sharp.
- Refrigerant is under high pressure. Always evacuate any system before attempting to open it.
- Reasonable care and safe work methods should be practiced when working on any appliance.
- Never work with energized electrical equipment in wet or damp areas.
- Use an appropriate work area and location when performing repairs. Under counter appliances are much easier to repair if they are set on a raised platform or workbench.
- Protective safety glasses are recommended.
- Any refrigerant, whether CFC, HCFC, or HFC (R-12, R-22, or R-134a), must be recovered. Federal regulations prohibit the intentional venting or release of refrigerants during the service repair or disposal of an appliance.

1.4 Basic Refrigeration Tools

The following list contains some of the tools required for basic refrigeration repairs:

1. Hoses with R-134a couplers (must meet standards for handling R-134a refrigerant)
2. Approved and certified recovery system for R-134a
3. Manifold gauge set or a short length of charging hose for R-134a
4. 25 pound charging cylinder with R-134a
5. Electronic refrigerant scale
6. Access valves or process kit
7. Pinch off tool
8. Small, fine grade, 3-corner file or appropriate cap tube cutting tool
9. Small and large tubing cutter
10. Oxy-Acetylene or Map-Pro torch
11. Swaging tools
12. Digital multi meter
13. Leak detection equipment
14. Standard hand tools (assorted Phillips and standard screwdrivers, sockets, Allen wrenches, combination wrenches / adjustable wrenches, needle nose / slip joint pliers etc.)
15. Rivet gun and assorted rivets
16. Drill motor with assorted drill bits and hex head sockets
17. Wire strippers and crimpers

1.5 Basic Installation

- Units can be installed freestanding* or built-in. The front of the unit must be unobstructed for proper air circulation and operation at all times.
- **NOTE:** * Professional and overlay door models cannot be installed free standing. Units with the “*Articulating Hinge*” must be installed as built-in due to safety restraints.
- Area should be ventilated and without exposure to extreme temperatures.
- Unit must be installed indoors and away from the elements of nature. These units do not have certification from any agency for outdoor installation.
- Any exceptions, alterations, or modifications to the appliance as manufactured will void the warranty.
- These units must be installed on a flat, level surface capable of supporting the loaded weight of the appliance.



WARNING

HAZARD OF ELECTRICAL SHOCK

Failure to disconnect the supply voltage to the appliance prior to servicing could result in an electrical shock or possible death.

1.6 Electrical Requirements

- 115 / 120 VAC, 60 hertz, single phase power is required.
- Use an outlet with a 15 amp delayed action fuse or circuit breaker. **DO NOT PUT A FUSE ON THE NEUTRAL OR GROUND SIDE OF THE CIRCUIT.**
- A properly grounded outlet is required for this appliance.
- It is recommended that a single circuit receptacle be used for this appliance. Multiple appliances on the same electrical circuit are not recommended.
- **DO NOT** use an extension cord or multi-purpose surge protector device.

Section 2: Sealed System

2.1 Introduction

The following should always be practiced with any sealed system that has been opened. Only open the sealed system after proper diagnosis has verified a system issue. Eliminate any possible non system related problems such as wiring, control system, airflow, etc. before attempting a sealed system repair. Many times these possibilities can resemble sealed system problems. Checking the evaporator frost pattern is a great way to determine if a possible charge related problem is evident.

1. Use a leak detection system that will detect R-134a refrigerant. Check both the high and low sides slowly for minuscule leaks.
2. The drier must be replaced anytime the sealed system is opened. Always use an unopened and approved drier. Failure to do so may cause repeated system failure in the future.
3. Limit time the system is opened. **DO NOT EXPOSE THE OPEN SYSTEM FOR MORE THAN 15 MINUTES.** This could result in a sealed system failure. Leave replacement parts sealed and unexposed to the surrounding atmosphere until they are ready to install.
4. Replacing the compressor for a low side leak is not always mandatory. If the system has not been purged dry of refrigerant and oil as a result of a low side leak, the sealed system should not be compromised. However, if the system has been purged completely of refrigerant, a compressor replacement should be completed. Moisture has been drawn into the system if the unit has been running dry for an extended period of time. Be sure to flush the system with dry nitrogen gas and evacuate to 50 microns before re-charging.
5. A new evaporator assembly must be ordered if the capillary tube is found to be plugged or severely restricted. Restrictions cannot be flushed out.
6. Be sure to purge the system after final brazing. This will flush out any air or moisture that may have entered the system before being absorbed into the ester oil.
7. A sealed system that has been contaminated by moisture is a very costly repair for the customer. If the appliance is still under warranty, it would be best to contact the manufacture for recommendations for either a sealed system replacement or appliance replacement.

2.2 Low Side Leaks

Low side leaks consist of a break in the system at the evaporator, suction line, or compressor. If a leak is found in any of these areas, there is a possibility that moisture has been introduced into the sealed system. The compressor and drier will have to be replaced and the system will need to be flushed thoroughly with nitrogen gas and evacuated to 50 microns before re-charging.

2.3 High Side Leaks

High side leaks consist of a break in the system at the compressor, condenser, discharge tubing, drier, or capillary tube. If a leak is found at any of these areas, replace or repair the leak. Flush the system with nitrogen gas, evacuated to 50 microns, and recharged.

2.4 Restricted Capillary Tube

Moisture or other contaminants that enter the system can cause non condensable deposits in the system. These deposits will usually collect in the capillary tube and form a restriction that cannot be removed by flushing. If moisture is found in the system, the entire system has been compromised due to the unstable relationship between ester oil and moisture.

For non-moisture related restrictions: If the capillary tube is restricted, typically the restriction is at the inlet end, inserted into the drier. This can be repaired by cutting off approximately 1" of capillary tube, inserting the cut end into a new drier, and re-soldering the joint. If the leak is elsewhere in the capillary tube, it would be best to replace the evaporator / heat exchanger assembly, pull a satisfactory vacuum and recharge.

2.5 Access/Process Valves

A temporary access valve can be used to service or evaluate the system. From these temporary access valves, you can recover, evacuate, and re-charge the system. The access valve will be installed on the compressor's process tube (low pressure side). Be sure to cap off the access valve if you have not completed servicing. This will prevent contamination of the system and temporarily prevent refrigerant from leaking. After servicing is complete, the temporary valve must be removed from the sealed system. A pinch-off tool can be used to close off the process tube downstream from the valve piercing. Once this is done, the temporary valve can be removed and the pierced section of the process tube cut off. The open end of the process tube can now be soldered/brazed shut to seal the system. Be sure to leak check after brazing. If a permanent soldered/brazed Schrader valve is used, the cap must be snugged firmly after service is completed.

2.6 Evaporator Frost Pattern

In the past Marvel has always recommended not using a gauge set to determine system capacity and pressures. The amount of refrigerant in these systems is so minute, that any amount of charge lost during gauge installation or removal can be detrimental to the refrigeration system.

It was determined that checking the frost pattern on the evaporator was always a good indicator for reference.

The following procedure was recommended to check a typical cold plate evaporator:

“Checking the evaporator frost pattern is a good way to quickly diagnose simple sealed system problems. This can be done by allowing the unit to run (at least 10 minutes) with the door open for at least 5 minutes. This will help speed up the normal frosting of the evaporator plate. By visually inspecting the evaporator and feeling it with your hands, you will see and feel as the frost pattern builds across the plate. The frost pattern should cover a majority of the evaporator plate. This will ensure the system has been charged correctly and does not have a leak, partial restriction, or is undercharged. A partial frost pattern may lead to excessive run times, reduced performance and efficiency.”

With the design of the new enhanced cabinet and low side design, checking the evaporator plate in the above description has become somewhat complicated.

As an alternative to the above method, we offer two varying methods.

- 1) The first method is similar to the above. However, with the compressor running, the interior evaporator cover must be removed, the evaporator fan disconnected, and the door left open for observation for 10 minutes. The evaporator plate should show a slight full frost pattern similar to the photo below with a typical factory refrigerant charge as stamped on the manufacturer’s serial plate.



- 2) The second method which is somewhat unproven at this time is to measure the temperature of the filter drier. A rule of thumb is that the drier temperature should be approximately 90° F at a 70° F ambient temperature.
 - **AGA Marvel does not recommend taking system pressures and does not have a reference table to use for diagnosing or charging.**

2.7 Measuring Evaporator Temperature

There are a couple of ways to measure temperature of the evaporator plate:

1. Use a thermocouple to measure the temperature of the evaporator plate. The thermocouple must be secured to the evaporator when taking the measurement.
2. If it has been determined that there is proper contact between the sensor and evaporator plate, the sensor resistance value can be interpolated to be the approximate evaporator temperature.

2.8 Re-charging



CAUTION

THIS IS A CRITICALLY CHARGED APPLIANCE
Charging by a weight system is recommended.

Re-charging of the unit should be done only after diagnosing and repairing the system. Be sure to flush the system with dry nitrogen gas and evacuate to 50 microns before re-charging.

Vacuum Chart	
Vacuum: Inches Hg.	Microns
28.94	25000
29.53	10000
29.832	4600
29.882	1000
29.901	500
29.915	150
29.917	100
29.919	50

Vacuum Pump Tips:

- 1) Remember to change vacuum pump oil after evacuating a ***contaminated*** system.
- 2) Frequent oil changes will increase the pumps potential to achieve the best vacuum possible.
- 3) Use recommended oil per recommendation of vacuum pump manufacturer.

Charge the unit to the specified amount (See unit specifications or serial plate for charge specifications per model).

Listed below are two variations to correctly charge the sealed system

- **Method 1- DIAL-A-CHARGE**
- **Method 2- Weigh in Liquid on High Side**

DIAL-A-CHARGE Method

Using a length of manifold hose, connect one end to the manifold, the other end to the weighted charging cylinder.

Adjust cylinder to weigh in the correct amount of refrigerant into system based on nameplate charge.

It is best to use low loss fittings on hoses to avoid loss of charge when removing hoses.

Purge air from cylinder hose to manifold by loosening cylinder hose at manifold and bleeding liquid through hose to manifold.

Open manifold and charge unit.

Run unit for at least 10 minutes to confirm that the unit has a full frost pattern on the evaporator and that the unit is not overcharged and there is no liquid returning back to the compressor.

It is normal to have some condensation or slight frost on the suction line. Typically this will occur towards the end of a run cycle. If the frost continues down the suction line to the compressor, the system is overcharged.

Once the system is charged, clamp off the process tube downstream from the access valve. Remove the valve, cut off the extra process tube with the piercing, fill the open end of the process tube with solder. Remove the clamp from the process tube and leak check.

Weigh in Liquid on High Side Method

NOTE: When using this method an access valve should have been attached to the compressor process tube (low side) and the high side process tube on the drier.

Using a length of manifold hose, connect one end to the manifold, the other end to the refrigerant cylinder.

It is best to use low loss fittings on hoses to avoid loss of charge when removing hoses.

Purge air from cylinder hose to manifold by loosening cylinder hose at manifold and bleeding liquid through hose to manifold.

Set refrigerant cylinder on scale and turn scale on allowing it to stabilize and then zero scale.

Open manifold high side port and *carefully* charge unit to nameplate weight of charge by watching scale.

Once the appropriate charge is weighed in, allow pressures to equalize.

Run unit for at least 10 minutes to confirm that the unit has a full frost pattern on the evaporator and that the unit is not overcharged and there is no liquid returning back to the compressor.

It is normal to have some condensation or slight frost on the suction line. Typically this will occur towards the end of a run cycle. If the frost continues down the suction line to the compressor, the system is overcharged.

Once the system is charged, clamp off the process tube downstream from the access valve.

Remove the valve, cut off the extra process tube with the piercing, fill the open end of the process tube with solder. Remove the clamp from the process tube and leak check.

If you are using a soldered access fitting be sure to remove high side hose after the system has equalized and before starting unit to check frost pattern.

Cap access fittings tightly and leak check system with unit off so that pressures are equalized throughout the system.

2.9 Temperature / Pressure Chart

F°	R-134A (PSIG)	F°	R-134A (PSIG)	F°	R-134A (PSIG)	F°	R-134A (PSIG)
-30.6	10	31.1	27	61.23	59	121.5	175
-27.02	8	32.27	28	62	60	123.3	180
-23.7	6	33.43	29	62.75	61	125.2	185
-20.59	4	34.56	30	62.5	62	126.9	190
-17.67	2	35.68	31	64.24	63	128.7	195
-14.92	0	36.77	32	64.98	64	130.4	200
-12.31	1	37.85	33	65.71	65	132.1	205
-9.84	2	38.91	34	66.43	66	133.8	210
-7.47	3	39.96	35	67.14	67	135.5	215
-5.21	4	40.99	36	67.85	68	137.1	220
-3.04	5	42	37	68.55	69	138.7	225
-0.95	6	43	38	69.24	70	140.2	230
1.05	7	43.98	39	72.62	75	141.8	235
2.99	8	44.95	40	75.86	80	143.3	240
4.86	9	45.91	41	78.98	85	144.8	245
6.67	10	46.85	42	81.97	90	146.3	250
8.42	11	47.78	43	84.87	95	147.7	255
10.12	12	48.7	44	86.66	100	149.2	260
11.77	13	49.61	45	90.37	105	150.6	265
13.38	14	50.51	46	92.99	110	152	270
14.94	15	51.39	47	95.53	115	153.4	275
16.46	16	52.26	48	98	120	154.7	280
17.95	17	53.13	49	100.4	125	156.1	285
19.4	18	53.98	50	102.7	130	157.4	290
20.81	19	54.82	51	105	135	158.7	295
22.19	20	55.65	52	107.2	140	160	300
23.55	21	56.48	53	109.4	145	161.3	305
24.87	22	57.29	54	111.5	150	162.5	310
26.16	23	58.1	55	113.6	155	163.8	315
27.43	24	58.89	56	115.6	160	165	320
28.68	25	59.68	57	117.6	165	166.2	325
29.9	26	60.46	58	119.6	170	167.4	330

Section 3: Sealed System Components

3.1. Toe Grill Removal

1. Remove both Phillip screws on each end of the toe grill.
2. There is an oval spacer held in place by each screw, located behind the toe grill. This is to help give an aesthetic appearance once the grill is adjusted and tightened.



Remove each Phillip screws on both ends of the toe grill.

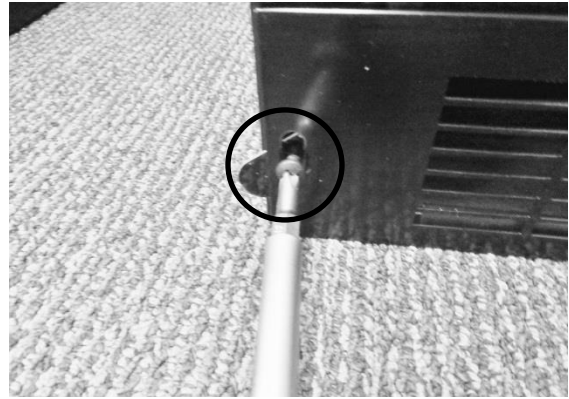

The oval toe grill spacer is visible in the above picture.

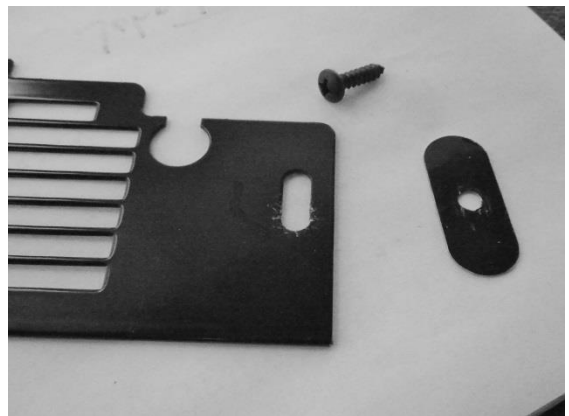

Right and left hand views of the toe grill, screen and spacer.

NOTE: When reinstalling the toe grill care must be taken to be sure that the communication cable is routed through the correct area in the toe grill.

- The below left hand photo shows the correct routing of the communication cable, it must pass freely with clearance on all sides.
- The below right hand photo shows the incorrect routing of the communication cable. It is very easy for the cable to end up in this position if care is not taken when reinstalling the toe grill. This is a critical pinch spot and will create a service call in the future with either a frayed or cut cable.
 - **NOTE:** Always ensure that the plastic cable grommet is installed correctly.



CORRECT wire position- Inside grommet.

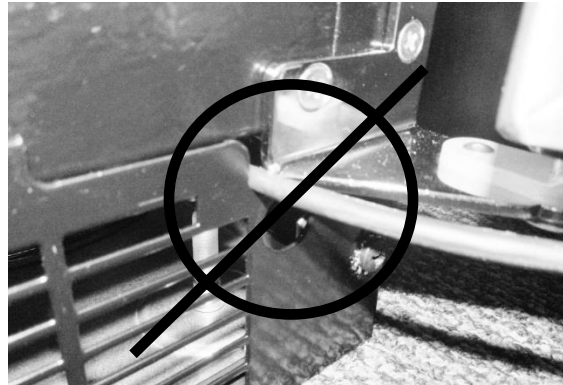

INCORRECT WIRE POSITION.

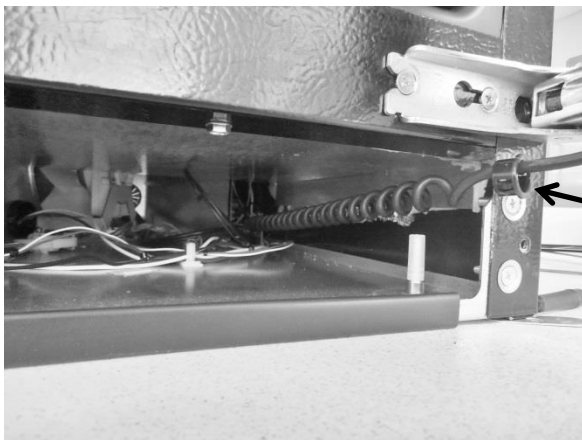

Grommet after toe grill is removed.

3.2: Warnings and Cautions

WARNING

Prior to removing the access cover to the machine compartment, disconnect the supply voltage to the appliance; failure to do this could result in an electrical shock or possible death.

CAUTION

All electrical parts and wiring must be shielded from torch flame. DO NOT allow torch to touch insulation; the insulation will char at 200°F and flash ignite (burn) at 500°F. Excessive heat will distort the plastic liner.

3.3 Accessing the Mechanical Compartment

Access to the mechanical compartment is located at the rear of the unit. Most mechanical and electrical components on the unit mount directly to the slide out base.

To gain access to the mechanical section proceed as follows, be sure to reference the photos as called out.

1. For access to the machine compartment remove the screws securing the compartment panel at the rear of the cabinet.
2. For additional service needs it may be necessary to slide the machine compartment assembly out. Proceed with the following steps.
3. Back out the two Phillips screws (1 on each side) on the toe grill.
4. Once the toe grill is removed, it will be necessary to remove all four screws (two on each side) to loosen the mechanical assembly from the front.
5. At the rear bottom corner of the unit two (1 on each side) 5/16" hex head screws can be removed.
6. The mechanical section can now be slid out no more than 2 - 4" maximum until the suction line has been unsoldered from the compressor*.

➤  **WARNING:** The refrigeration system must be evacuated prior to unsoldering the compressor or any other system related component.

7.  **CAUTION:** To avoid kinking the suction line assembly - do not slide the mechanical base outward past the 4" maximum recommended above.



Remove all perimeter 5/16" screws that secure the back panel – DO NOT remove the 5/16" hex screws in the bottom left and right hand side corners, or the Phillips head ground screws.

Remove both Phillips screws and grill.



Remove both top and bottom screws on each side.

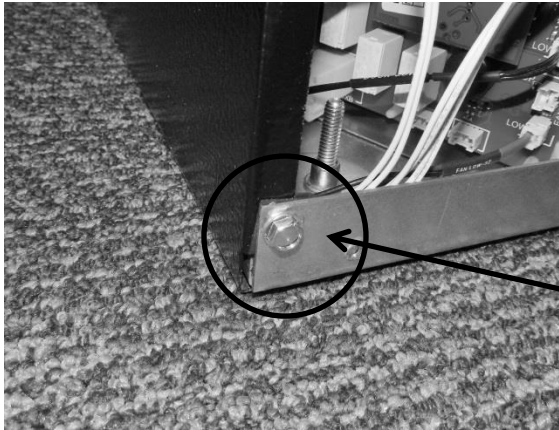

Remove both screws.

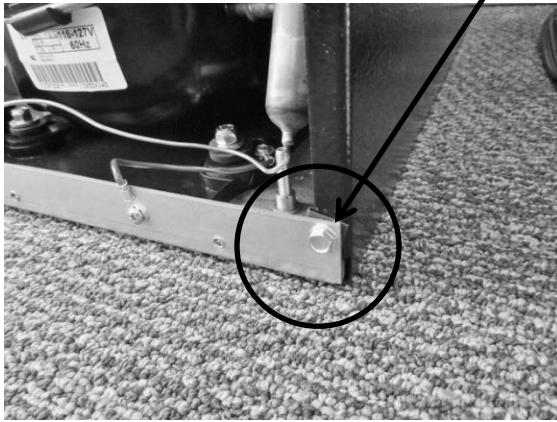

**Maximum distance to
remove bottom of
machine
compartment: 2 - 4"**

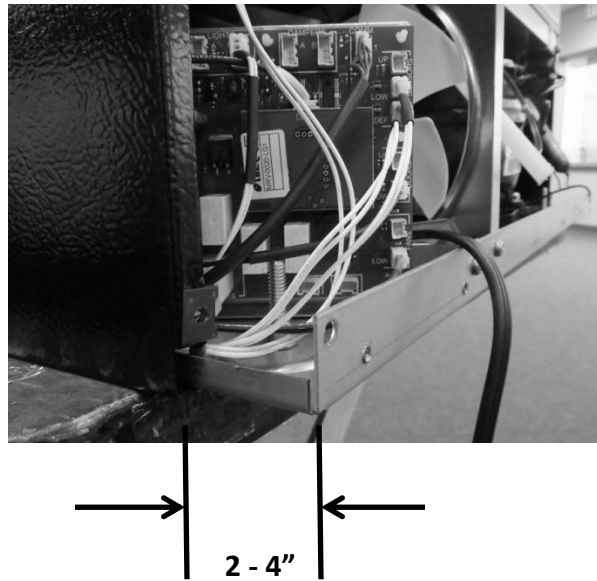

3.4: Compressor

The following tests should be conducted before concluding the compressor is faulty.

1. Low and high side pressure, temperature of compressor, discharge and suction lines, temperature of air leaving the evaporator compartment, temperature of condenser coil, condenser fan operation, and amp draw at compressor.
2. Use a compressor start cord to isolate and test the compressor.
3. Use an ohmmeter to measure resistance / continuity at the compressor to check for shorted or grounded windings.
 - a. Resistance between the "Common" and "Run" terminals: this will be the lowest ohm reading obtained.
 - b. Resistance between the "Common" and the "Start" terminals: this will be the mid-range ohm reading obtained.
 - c. Resistance between the "Start" and "Run" terminals: this will be the highest ohm reading obtained (This should equal the combined total of the previous two readings).
 - d. No resistance between any two terminals signifies an open winding.
 - e. Check continuity between compressor terminals and the compressor itself (Scrape off a little paint on compressor to make sure that resistance can be measured). If continuity is obtained, the compressor is grounded and needs to be replaced.

3.4.1: Check Compressor Winding Resistance:

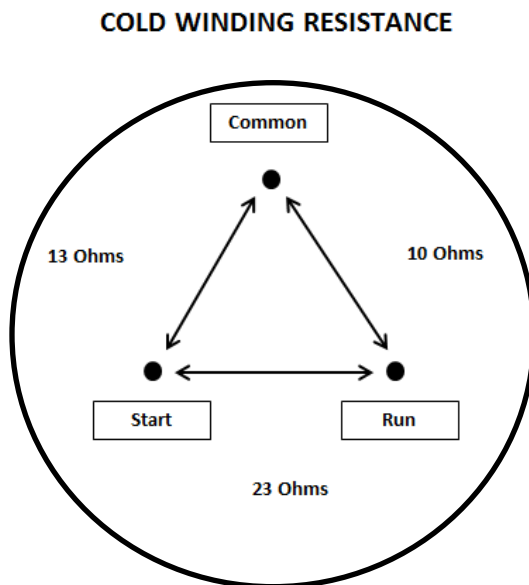

3.4.2: Remove the Compressor

1. Disconnect power to the unit.
2. Follow the exact steps outlined in *“Sealed System Components”* to access the compressor.
3. Using the process tubes, install sealed system access valves and recover refrigerant.
4. Remove the TSD2 starter package from the compressor terminals.
5. Unsolder and remove the discharge and suction lines from the compressor.
6. Unsolder and remove the filter / drier.
7. **Cap all refrigeration lines:** It is advisable that all exposed refrigeration lines be capped if the system will be exposed to the atmosphere for any length of time.
8. Remove the three 7/16” nuts, washers and grounding screw from compressor mounting bolts. There is no nut and washer at the back, left hand mounting position.
9. Lift the compressor off the mounting bolts.

3.4.3: Install a New Compressor

1. Do not remove the rubber plugs from the compressor tubes at this time.
2. Install the four (4) rubber grommets onto the compressor base.
3. Install the three sleeves where the carriage bolts are located.
4. Mount the compressor into position on the mechanical base.
5. Install the three washers and lock nuts and tighten snugly into place. Do not over tighten.
6. Install and solder a new filter drier in the system.
7. Remove rubber plugs from compressor tubes.
8. Solder a new process tube to compressor.
9. Solder the discharge and suction lines back into compressor.
10. Re-install TSD2 starter package to compressor terminals.
11. Connect service ports to both the high and low sides of system.
12. Evacuate, charge to serial plate recommendation, and leak check the sealed system.
13. Push the mechanical base assembly back into place.
14. Secure base assembly to cabinet at rear and front locations.
15. Replace the front grill and back panel.

3.5: Condenser

The condenser is of tube and wire construction. It is draw through; forced air technology used for heat transfer. The front grill facilitates both intake and exhaust air. A fiber board air baffle is located between the front grill and the rear machine compartment access panel. This baffle separates the air intake (left hand side) and exhaust (right hand side) across the condenser.

A common problem with this system is restricted air flow caused by lint, dust, dirt, and pet hair. These particles become built up on the condenser and results in overheating due to the lack of sub-cooling across the coil.

NOTE: Another important factor is that the free air space on the toe grill cannot be altered to meet a certain design criteria. Any modifications could jeopardize the integrity of the appliance performance.

3.5.1: Remove the Condenser

1. Disconnect power to the unit.
2. Follow the exact steps outlined in “Sealed System Components”.
3. Install sealed system access valves and recover refrigerant.
4. Except for the “Data” and the “Communication” cable, all small connections must be disconnected from the main power board. These two cables will stay with the mechanical base and removed from the cabinet assembly. In addition the two larger connectors DO NOT have to be disconnected from the board.
5. Unsolder and remove the filter / drier.
6. Unsolder and remove the discharge and liquid lines from the condenser.
7. Using a 3/8” nut driver or socket, remove (1) 3/8” nut securing each condenser mounting bracket to the mechanical base.
8. The condenser assembly can now be removed from the base assembly.
9. Use a Phillips screwdriver to remove the condenser brackets from each side of the condenser. The brackets will slide out once the screws are removed.
10. It is advisable that the un-soldered copper tubes be capped if the system will be exposed to the atmosphere for any length of time.

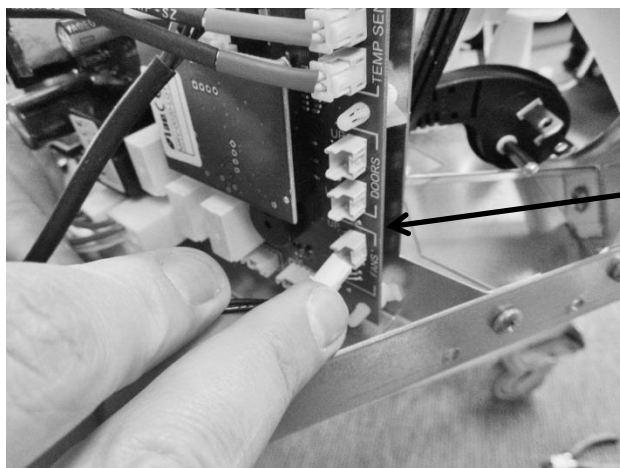

Disconnect recommended connectors.



Slide out the bottom of the machine compartment far enough to unsolder condenser lines.



Condenser can be lifted away from bottom assembly after following step 7 above.



NOTE: On machine compartments with LEFT HAND SWING doors, a shield is added to prevent the communication cable from being drawn into the condenser coil. It is anchored using the same nut which secures the condenser mounting bracket.

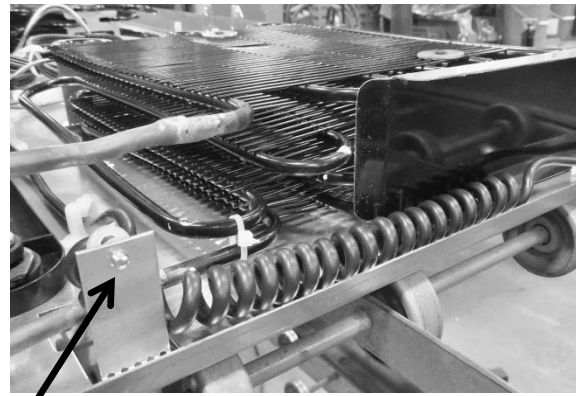

The above bracket is used on LEFT HAND SWING doors to anchor the back end of the communication cable.

3.5.2: Install a New Condenser

1. If necessary, reattach the mounting brackets to each side of the condenser with the Phillips screws and washers previously removed.
2. Ensure that the carriage bolts for mounting the condenser brackets are in place on the bottom of the machine compartment.
3. Install the new condenser with brackets over the mounting studs and secure with the nuts previously removed.
4. Install and solder the discharge and liquid lines to condenser.
5. Install and solder a new filter drier in the system.
6. Evacuate, charge to serial plate recommendation, and leak check the sealed system.

7. Carefully reconnect all electrical terminals back on the terminal board.
8. Carefully push slide-in mechanical base plate assembly back under cabinet.
9. Secure base assembly to cabinet at rear and front locations.
10. Secure base assembly and toe grill.

3.6: Evaporator

The evaporator removes heat from the inside of the unit ultimately making the interior of the appliance cold. The evaporator plate is flat in appearance (cold plate) and is installed behind the coil cover.

It is normal for the evaporator to frost up during its run cycle. This frost will dissipate once the unit reaches its “cut out” temperature and the compressor and fan stop. This condensate water will drop off the evaporator plate and down into the tapered sump area formed in the cabinet. The condensate will then drain down into the compressor condensate pan where it will evaporate. It is very important that the evaporator frosts in a uniform pattern across the plate. A partial frost pattern can lead to excessive run times and cooling issues.

Supply air is drawn across the evaporator plate from the evaporator fan and into the cabinet interior through the supply louvers located at the bottom of the coil cover.

NOTE: Refer to Section 19 for a Service Bulletin regarding the removal of the Evaporator / Heat Exchanger Assembly.

3.6.1: Remove the Evaporator



CAUTION

Sharp burrs can result in cuts.

1. Disconnect power to the unit.
2. Use steps in Section 8 for access to evaporator compartment.
3. Follow the exact steps outlined in “*Sealed System Components*”.
4. Install sealed system access valves and recover refrigerant.

NOTE: The evaporator heat exchanger is foamed in place in the back cabinet wall.

If an evaporator replacement is necessary, the heat exchanger will have to be cut at the point it enters the foamed cabinet (behind evaporator plate). The suction line will also have to be cut at the point where it enters the foamed cabinet from the machine compartment.

5. Remove the white foam evaporator spacers. Save as they will be used for the new evaporator assembly.
6. Remove the evaporator and discard, caution of sharp edges from the cut tubing.
7. Unsolder suction line from compressor and discard, again use caution of sharp edges surrounding cut heat exchanger.

8. Remove liquid and capillary lines from filter drier.
9. Drill a ½" hole in the left hand corner of the drain sump as close to the side wall as possible. The hole must extend into the machine compartment.
10. Remove any sharp burrs on the roof of the machine compartment created by the drill bit.

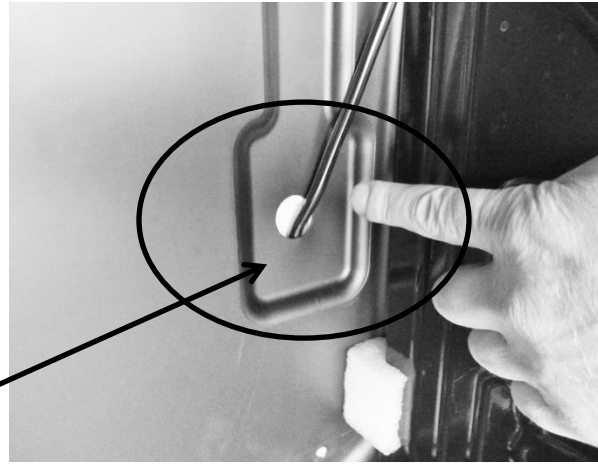

Cut away suction line at the above locations.



Drill a ½" hole downward into machine compartment. See recommendations in step 9 above.



Extend new assembly through the hole. Make sure ends are capped.



Install vibration isolator on heat exchanger assembly behind evaporator.



Cut the suction tube extension to connect the compressor to the suction line.

3.6.2: Install a New Evaporator

NOTE: A replacement evaporator assembly (42249079) will include the following components:

- (1) Evaporator heat exchanger assembly
 - (1) Filter drier
 - (1) Pre bent suction tube extension
 - (1) Vibration Isolator
 - (2) Nylon zip tie fasteners
 - (2) Pieces of permagum
1. Take the replacement evaporator and unroll the capillary tube on the heat exchanger.
 2. Absolutely make sure that the ends of the capillary tube and suction line are well capped. Wrap both ends with tape to insure that no foam enter the tubing when passing it through the ½" drilled hole. Any foam that is allowed in the tubing will compromise the sealed system.
 3. Once the new evaporator is in place, the extended suction line into the machine compartment will have to be bent (thumbs and forefingers) at an angle towards the compressor.
 4. Carefully recoil the capillary tube.
 5. Install a new filter drier and solder the capillary and liquid line in place.
 6. The kit will include a section of pre-bent suction line. The bent side will be soldered into the compressor.
 7. Use a 3/8" swedging tool to expand the opposite end of the suction extension to fit over the new suction line extending into the machine compartment. This connection can now be soldered.
 8. Evacuate, charge to serial plate recommendation, and leak check the sealed system.
 9. The kit also includes a rubber vibration isolator, place this onto the heat exchanger behind the evaporator to protect against tube rattles between the evaporator and cabinet liner.
 10. Replace the defrost thermistor and attach with the two zip lock fasteners in the kit.
 11. Place one piece of permagum around the new evaporator opening in the interior of the cabinet. Make sure that it is worked into and around the hole to seal off any moisture or heat.
 12. Use the second piece of permagum and also work that into and around the hole in the machine compartment where the new heat exchanger exits the liner.
 13. Re-install the white foam spacers. The spacers have an off center cut on one side, place the fat side of the spacer (the thickest foam slot) towards the back wall of the liner.
 14. Reassemble the coil cover and interior components in reverse order as removed.
 15. Reinstall the machine compartment back in place and secure in place at the front and rear of the cabinet.

Section 4: Electrical Component Access

4.1: Condenser Fan

The condenser fan is used to force air over the condenser coil. The condenser fan cycles on and off simultaneously along with the compressor.

1. Make sure that the motor shaft turns freely. The blade can be turned in either direction to verify that the shaft is not seized or the blade binding. Watch the blade and listen for any noise that might indicate a problem.
2. Check resistance between the terminals of the motors power cord. Replace the motor if the windings are shorted (open).

4.1.1: Fan Assembly Removal

1. Remove Phillips head screw securing the condenser fan shroud.
2. Loosen the tape that holds the fiber board divider to the rear of the fan shroud.
3. Remove the white and red wires attached to the compressor electrical package.
4. Push both the white and red wires all the way through the black perforated plug.
5. Turn the rear of the fan shroud assembly towards your right (clockwise) as far as possible.
6. Tip the fan assembly forward until it clears the top of the machine compartment.
7. The fan assembly can now clear the mechanical compartment.
8. Disconnect the fan assembly at the connector harness.



Remove bolt and nut.



Loosen tape.

NOTE: Refer to Section 19 for a Service Bulletin regarding the removal of the Condenser Fan Assembly.

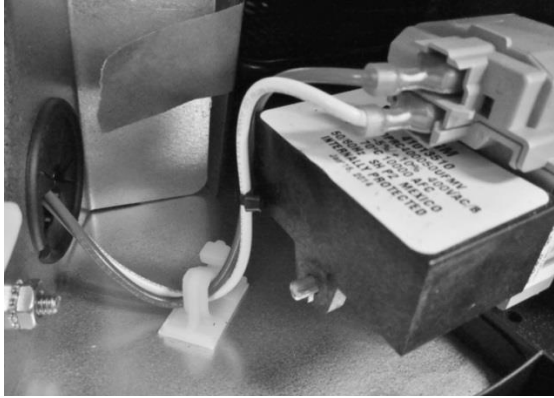

Disconnect red and white wires.

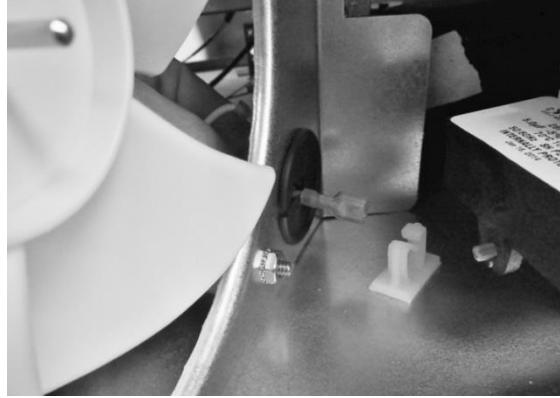

Pull wire through grommet.

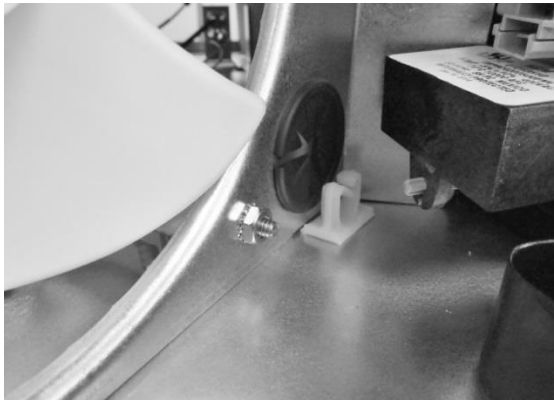

Rotate shroud to right.



Tip shroud forward.

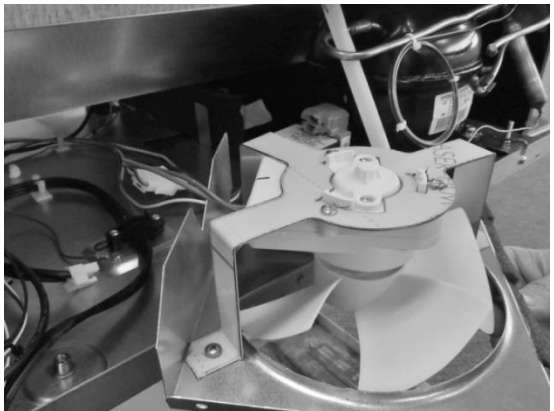

Lay shroud flat.



Disconnect connector.

Exploded View of Condenser Fan assembly

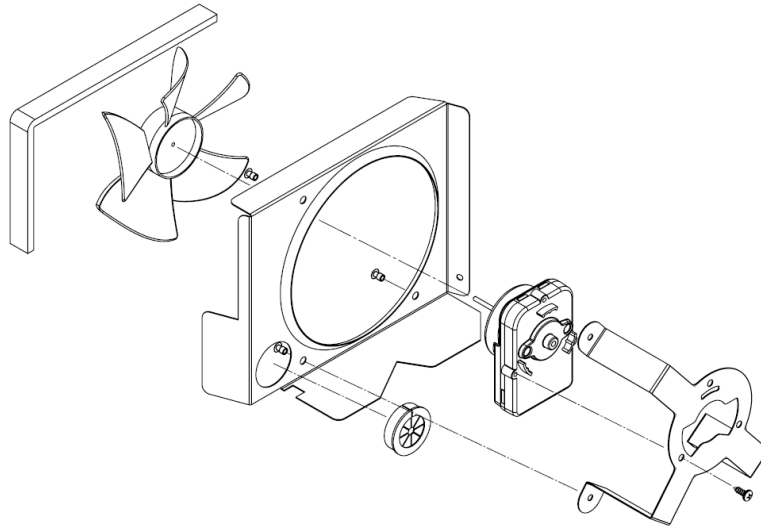

4.1.2: Condenser Fan Replacement

1. Remove the three Phillips screws on the rear of the motor bracket to replace fan motor.

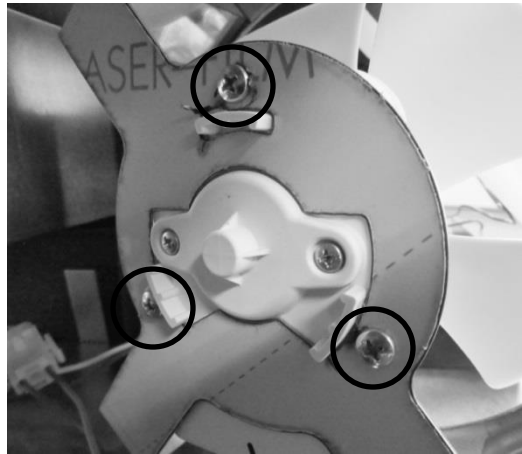

4.1.3: Fan Assembly Installation

1. Prior to reassembling the condenser fan assembly locate the slotted tab on the bottom of the machine compartment.
2. Next locate the notched recess on the bottom of the shroud assembly.
3. Upon assembly, the notched slot on the shroud assembly needs to slide in the slotted tab on the compartment bottom.

4. Once secure, the condenser wire harness along with the white and red compressor wires can be reconnected and the tape from the fiber board can be reattached to the fan shroud.
5. Reattach the assembly to the rear using the screw previously removed.



Bracket mounting tab.

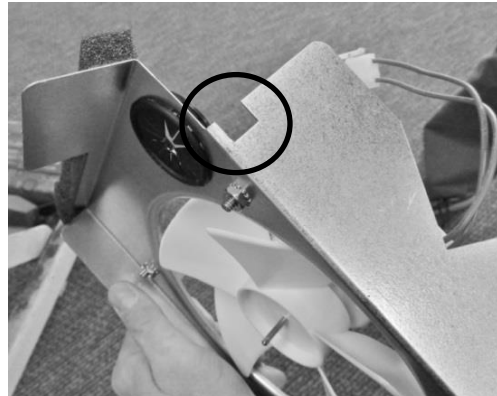

Bracket mounting slot.

4.1.4: Condenser Fan Blade Spacing

If the condenser fan blade has been removed from the motor shaft the fan blade must be properly re-spaced to achieve the optimal performance from the condenser.

- The correct distance from the tip of the fan blade to the front of the shroud is $9/16''$ (.56'')

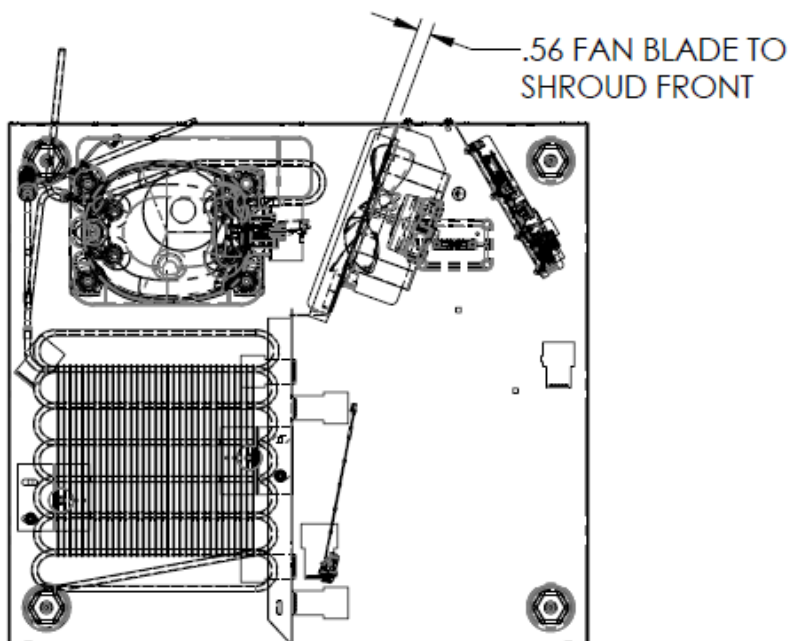

TOP VIEW
SCALE 1 : 8

4.2: Evaporator Fan Access

For all models, with the exception of the beer dispenser, the evaporator fan draws air from the refrigerated space through the bottom supply air louvers, across the evaporator plate, and then re-distributes it back into the cabinet through the fan itself.

The beer dispenser fan has reversed air flow. The evaporator fan is installed with the writing on the motor hub facing the rear of the cabinet; this creates a draw through application, pushing the air downward across the evaporator plate and out the bottom louvers on the evaporator cover.

To access the evaporator fan, follow the steps below:

1. Remove all shelving.
2. Remove decorative plastic screw caps.
3. Remove screws around the perimeter of the back panel.
4. If the appliance has cantilever shelving, the rails will have to be removed to expose the screw caps and screws securing the back panel.
5. Additionally with cantilever shelving the rear screw on thermistor shield will need to be removed as the thermistor is fed through the cantilever bracket.
6. The back panel is slotted mid-way up on the left hand side. This is to accommodate the thermistor.
7. The rear panel can now be removed.
8. The disconnect plug for the evaporator fan motor is located in the upper right hand corner.
9. ***See note on page 28 regarding air flow direction.***

NOTE: As of mid-August 2015, a rear fan guard was added to the fan assemblies on the beverage center models. The fan guard is to eliminate the possibility of wires getting caught in the fan blade from behind the coil cover.

The approximate serial number range is 20150824xxxH. This is an approximate date and some variation may be seen in the field.

An exploded view on the following page shows the assembly drawing of the coil cover components along with both the front and rear fan guards.

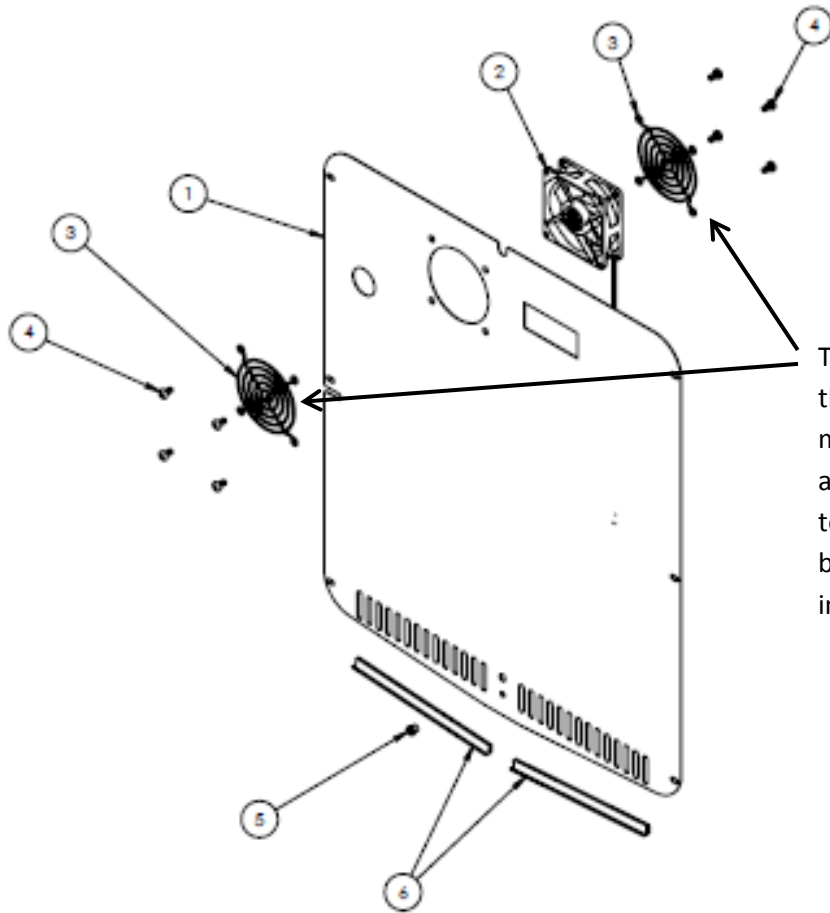

This exploded view drawing shows the front and rear fan guard. As mentioned on the previous page, the additional rear fan guard was added to outdoor beverage centers and beverage dispensers to prevent wire interference.

Disconnect all shelving and associated mounting brackets first – see above instructions

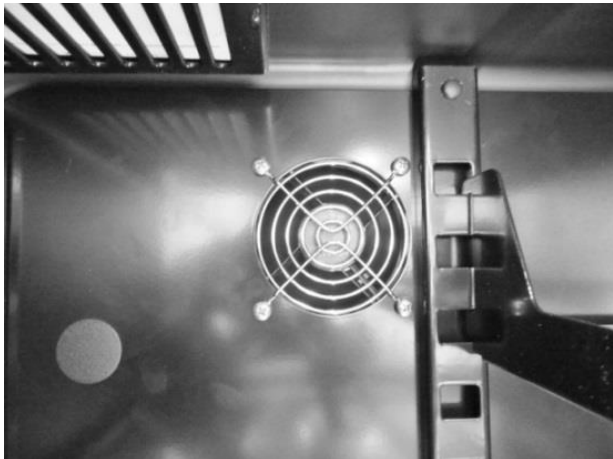

Fan location – do not attempt to remove from this view. Remove coil cover first.

Remove thermistor from the shield.

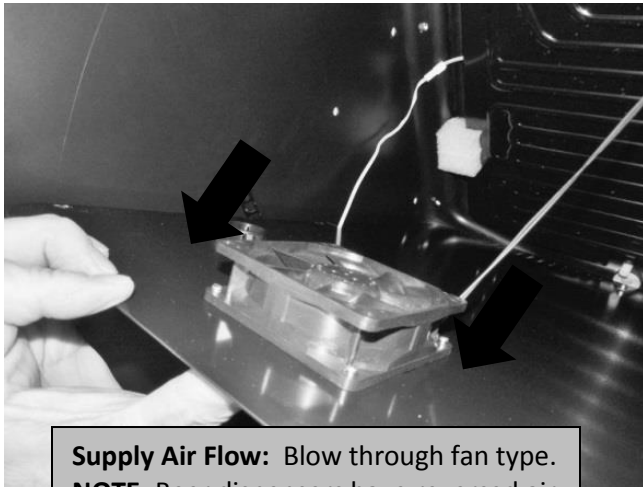

Supply Air Flow: Blow through fan type.
NOTE: Beer dispensers have reversed air flow (draw through).

Fan assembly attached to rear of coil cover.

NOTE: Newer beverage center models made after 20150824xxxH also have a rear fan guard.

Disconnect fan at harness connection.

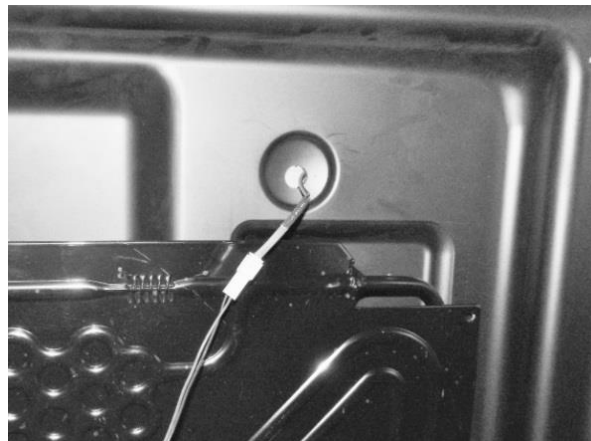

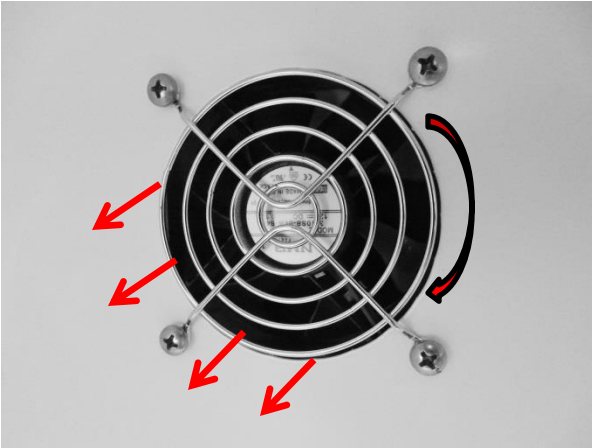

Most Models: Evaporator Air Flow: Fan is a blow through type. Specification label facing forward, the blade rotates clockwise as you face the hub.

Remove the four screws from the front of the coil cover to remove either fan.

Beer Dispensers: Evaporator fan (draw through). Specification label facing towards rear, the blade rotates counter-clockwise as you face the hub.

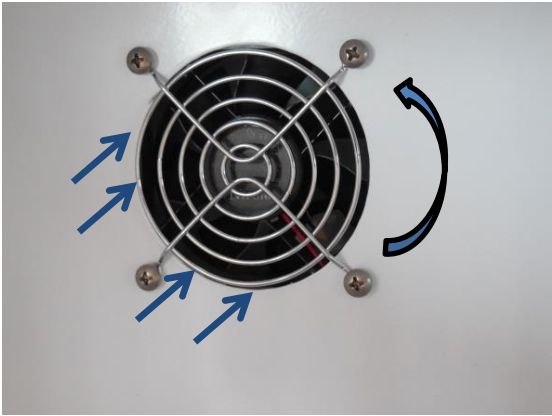

4.3: Thermistor Locations

The following shows typical thermistor locations

Cabinet Thermistor Locations

Refrigerated Drawers



Location: Midpoint on left hand side wall.



Beverage Centers

Location: Midpoint on left hand side wall.



Wine Coolers



Location: Midpoint on left hand side wall.

Defrost Thermistor Location

All Models

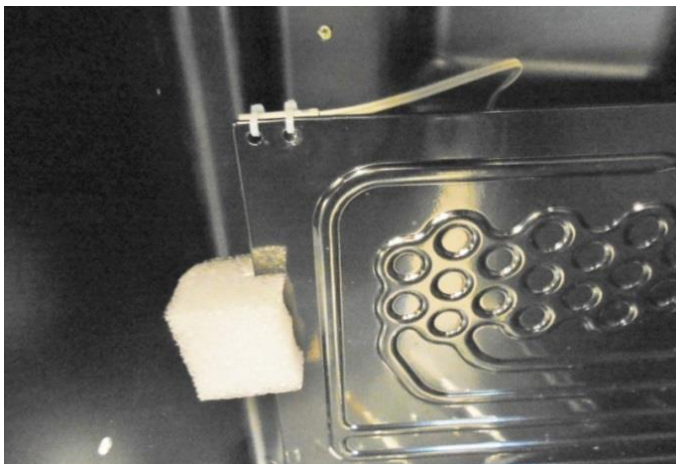

Location: Top left hand corner of evaporator.

Section 5: User Interface Display

5.1 Model Variations

NOTE: The User Interface Display appearance between the Glass Door and Solid Door / Drawer models. The Light key is missing on Solid Door and Drawer Displays.

Glass Door Models:



Solid Door and Drawer Models:



NOTE: Refer to Section 19 for a Service Bulletin regarding an alarm in the Showroom Mode.

5.3 User Interface Navigation – Beverage Centers



Figure 10
Electronic single zone control



To wake the display press any keypad. A confirm tone will sound, and the current storage compartment temperature will be displayed.

Starting your appliance:

Plug the appliance power cord into a 115 volt wall outlet. Your appliance is shipped from the factory in the "On" position and will begin start-up of cooling as soon as power is supplied. If the appliance does not start, confirm that the wall outlet has power, and that the control is in the "On" position, (See "Turning your appliance On and Off" below).

The control display is covered with a clear plastic film. This film may be removed by carefully lifting the film at a corner.

On initial power up, the control display will indicate a "Power Failure" alarm. This is a normal condition as the appliance was powered-up at the factory for quality inspection and then removed from power. A momentary press of the "On/Off" keypad will reset this alarm condition. (See Alarms section on page 33).



The sleep mode can be disabled if you prefer to have the display on continuously. Press and hold the "Lock" keypad until the display goes past "Loc" and reads "nSL". To enable the sleep mode, repeat the instruction, again going past "Loc" until the display reads "SLP".



Sleep mode:

If no keypads are pressed for 60 seconds, the display will enter sleep mode to conserve power. The control panel will go dark with the exception of the system status "OK" indicator which will remain enabled. Alarm conditions will wake the display, (see alarms on page 33).

To make the following changes to the control settings (turning the appliance ON/OFF, adjusting the temperature, changing the interior lights, and activating vacation mode), the control must be awake.

Turning your appliance ON and OFF:

If the appliance is "On", (and out of sleep mode) the temperature will be shown in the display area of the control. To turn the appliance "Off", press and hold the "On/Off" keypad for 4-seconds. "OFF" will now be displayed on the control.



To turn the appliance "On", press and hold the "On/Off" keypad for 4-seconds.



Adjusting the temperature:

To set or check the set-point temperature (with the control out of sleep mode), press the "-" or "+" keypads. "SET" will be indicated on the user interface panel and the current set-point temperature will display and flash. Subsequent presses of the "-" or "+" keypads will adjust the temperature colder or warmer respectively. When you have reached your desired set-point temperature, press the "On/Off" keypad to accept, or do nothing and the "Set" mode will time-out in 10-seconds accepting the displayed temperature as the new set-point.

The available set-point temperature range for your appliance is 34°F (1.2°C) to 42°F (5.7°C). If you attempt to adjust the temperature outside of this range you will receive an audible notification.

When initially loading your product with warm contents, it may take up to 48-hours for the storage compartment temperature to stabilize.

When making temperature set-point changes, it may take up to 24-hours for the stored contents to stabilize at your new set-point temperature.

Factors that affect the storage compartment stabilized temperature:

- Changes to temperature setting.
- Room temperature changes.
- Temperature of stored contents.
 - Loading warm contents.
 - Cold content load will delay the change to a warmer set-point temperature.
 - Warm content load will delay the change to a colder set-point temperature.
- Usage, (number and duration of the door openings).
- Use of the storage compartment display lighting, (glass door product only).
- Installation of the appliance in direct sunlight or next to a heat source.



Interior display lighting: (Glass door models only)

Your appliance is equipped with a dual light level display lighting feature. With the control out of sleep mode press the "Light" keypad once to activate the interior lighting display feature at full illumination. A confirmation tone will sound, and the light bulb "Icon" will illuminate. Pressing the "Light" keypad a 2nd time will dim the lighting to 50%. A 3rd press will deactivate the display lighting feature. The display lighting will automatically deactivate after 4-hours.



Temperature mode:

The temperature mode is preset from the factory in Fahrenheit (°F) but you have the option to change it to Centigrade (°C). To change the mode, press and hold the "-" keypad, while pressing the "+" keypad, then release the "-" keypad. The temperature will now be displayed in Centigrade (°C). Repeat the procedure to change the temperature mode back to Fahrenheit (°F).



Control lock:

The control panel can be locked to avoid unintentional changes. To lock the control, press and hold the "Lock" keypad until the display reads "Loc" then release your finger from the keypad. The lock icon will flash 3-times and then continuously illuminate. When the control panel is locked, only the Lock keypad, System Status OK indicator, and the Alarm indicator are active. To un-lock the control panel, repeat this instruction until the display reads "nLc".

Alarms:

The control will alert you to conditions that could adversely affect the performance of the appliance.



- **Door ajar** - If the door is open, or not closed properly, for more than 5-minutes the System Status OK indicator will turn-off, the "Door Ajar" indicator will flash, and a tone will sound every 60 seconds. Additionally, an "ALARM RESET" indicator will be displayed below the "On/Off" keypad. This alarm condition can be reset by closing the door or momentarily pressing the "On/Off" keypad, (i.e.-if you are cleaning the storage compartment, etc.). The alarm will recur in 5-minutes if the alarm condition persists.



- **Power failure** - If power to the appliance is interrupted the System Status indicator will turn-off and the "Power Failure" indicator will flash. Additionally, an "ALARM RESET" indicator will be displayed below the "On/Off" keypad. No audible tone will sound. This alarm condition can be reset by momentarily pressing the "On/Off" keypad. If this alarm occurs, it is recommended that you check the condition of any perishables, even if the appliance is operating normally and the temperature has recovered, as prolonged power outages could result in excessive temperature excursions which may spoil perishables.

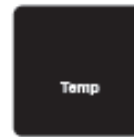

- **Temperature alarm** - If the storage compartment temperature exceeds 10°F from set-point for more than a 1-hour duration, the System Status indicator will turn off, the "Temp" indicator will flash, and an audible tone will sound every 60-seconds. Additionally, an "ALARM RESET" indicator will be displayed below the "On/Off" keypad. This alarm condition can be reset by momentarily pressing the "On/Off" keypad. If this alarm occurs it is recommended that you check the condition of your stored contents, even though the appliance is operating normally and the temperature has recovered, as prolonged temperature excursions could spoil perishables.

NOTE

A black square icon with the text "Door Ajar" and "Temp" in white, stacked vertically.

Door Ajar
Temp

Multiple alarms are possible, i.e.- "Door Ajar" for a prolonged period may trigger a "Temp" alarm, in which case both "Door Ajar" and "Temp" indicators will activate.

Vacation mode:

This operating mode can be used to save energy during high cost energy periods, or when you won't be using your appliance for an extended period of time by disabling the lights, alarm tones, and keypad entry tones. Vacation mode also serves as a Sabbath mode, disabling functions and its controls in accordance with the weekly Sabbath and religious holidays observed within the Orthodox Jewish community. When used as Sabbath mode, you may open or close the door at any time to access contents without concern of directly turning on or off any lights, digital read-outs, solenoids, fans, valves, compressor, icons, tones, or alarms.

When activated, the display, alarm indicators and tones, keypad touch tones, interior lights, and all options are disabled. All keypad functions are disabled, with the exception of the "On/Off" keypad which is required to exit Vacation-mode. Storage compartment temperatures are monitored and controlled at the settings prior to entering Vacation mode.

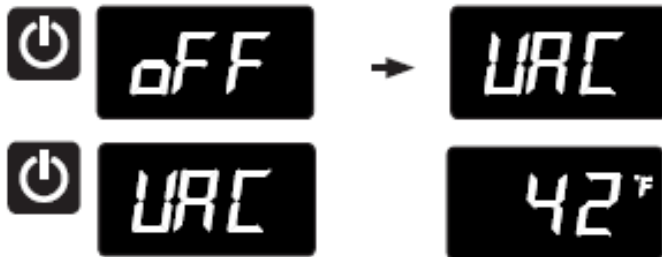

To enter Vacation Mode (with the control out of sleep mode), press and hold the "On/Off" keypad until the display goes past "OFF" and reads "VAC". The display will flash "VAC" 3-times to acknowledge your request, then will display "VAC" continuously until Vacation mode is exited. A power outage will not exit Vacation mode, exiting can only be accomplished manually. To exit Vacation mode and return to normal operation, press and hold the "On/Off" keypad until the control displays the temperature.

5.4 User Interface Navigation – Wine Coolers

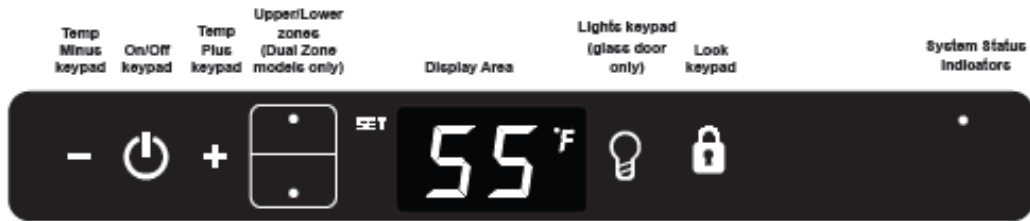

Figure 10
Electronic control



To wake the display press any keypad. A confirm tone will sound, and the current storage compartment temperature will be displayed.

Starting your appliance (Single and Dual Zone):

Plug the appliance power cord into a 115 volt wall outlet. Your appliance is shipped from the factory in the "On" position and will begin start-up of cooling as soon as power is supplied. If the appliance does not start, confirm that the wall outlet has power, and that the control is in the "On" position, (See "Turning your appliance On and Off" below).

The control display is covered with a clear plastic film. This film may be removed by carefully lifting the film at a corner.

On initial power up, the control display will indicate a "Power Failure" alarm. This is a normal condition as the appliance was powered-up at the factory for quality inspection and then removed from power. A momentary press of the "On/Off" keypad will reset this alarm condition. (See Alarms section on page 37).



Sleep mode (Single and Dual Zone):

If no keypads are pressed for 60 seconds, the display will enter sleep mode to conserve power. The control panel will go dark with the exception of the system status "OK" indicator which will remain enabled. Alarm conditions will wake the display, (see alarms on page 37).

To make the following changes to the control settings (turning the appliance ON/OFF, adjusting the temperature, changing the interior lights, and activating vacation mode), the control must be awake.



The sleep mode can be disabled if you prefer to have the display on continuously. Press and hold the "Lock" keypad until the display goes past "Loc" and reads "nSL". To enable the sleep mode, repeat the instruction, again going past "Loc" until the display reads "SLP".



Turning your appliance ON and OFF (Single and Dual Zone):

If the appliance is "On", (and out of sleep mode) the temperature will be shown in the display area of the control. To turn the appliance "Off", press and hold the "On/Off" keypad for 4-seconds. "OFF" will now be displayed on the control.



To turn the appliance "On", press and hold the "On/Off" keypad for 4-seconds.

Adjusting the temperature:

NOTE

When initially loading your product with warm contents, it may take up to 48-hours for the storage compartment temperature to stabilize.

When making temperature set-point changes, it may take up to 24-hours for the stored contents to stabilize at your new set-point temperature.

Factors that affect the storage compartment stabilized temperature:

- Changes to temperature setting.
- Room temperature changes.
- Temperature of stored contents.
 - Loading warm contents.
 - Cold content load will delay the change to a warmer set-point temperature.
 - Warm content load will delay the change to a colder set-point temperature.
- Usage, (number and duration of the door openings).
- Use of the storage compartment display lighting, (glass door product only).
- Installation of the appliance in direct sunlight or next to a heat source.



Single Zone Models:

To set or check the set-point temperature (with the control out of sleep mode), press the "-" or "+" keypads. "SET" will be indicated on the user interface panel and the current set-point temperature will display and flash. Subsequent presses of the "-" or "+" keypads will adjust the temperature colder or warmer respectively. When you have reached your desired set-point temperature, press the "On/Off" keypad to accept, or do nothing and the "Set" mode will time-out in 10-seconds accepting the displayed temperature as the new set-point.

The available set-point temperature range for your appliance is 40°F (4.5°C) to 65°F (18.4°C). If you attempt to adjust the temperature outside of this range you will receive an audible notification.

Lower zone enabled



Upper zone enabled



Dual Zone Models:

Temperatures can be set for each individual zone (upper and lower) in the dual zone wine cellar. To do so you must first enable the zone you want to set the temperature for. You do so by pressing the upper or lower button on the display. When pressed the LED light will be illuminated for the respective display.



To change the set temperature for a particular zone, with the zone enabled and out of sleep mode, press the "-" or "+" keypads. "SET" will be indicated on the user interface panel and the current set-point temperature will display and flash. Subsequent presses of the "-" or "+" keypads will adjust the temperature colder or warmer respectively. When you have reached your desired set-point temperature, press the "On/Off" keypad to accept, or do nothing and the "Set" mode will time-out in 10-seconds accepting the displayed temperature as the new set-point.

The available set-point temperature range for your appliance is 45°F (7.3°C) to 55°F (12.9°C) for the lower zone and 55°F (12.9°C) to 62°F (16.8°C) for the upper zone. If you attempt to adjust the temperature outside of these ranges you will receive an audible notification.



Interior display lighting (Single and Dual Zone): (Glass door models only)

Your appliance is equipped with a dual light level display lighting feature. With the control out of sleep mode press the "Light" keypad once to activate the interior lighting display feature at full illumination. A confirmation tone will sound, and the light bulb "Icon" will illuminate. Pressing the "Light" keypad a 2nd time will dim the lighting to 50%. A 3rd press will deactivate the display lighting feature. The display lighting will automatically deactivate after 4-hours.



Temperature mode (Single and Dual Zone):

The temperature mode is preset from the factory in Fahrenheit (°F) but you have the option to change it to Centigrade (°C). To change the mode, press and hold the "-" keypad, while pressing the "+" keypad, then release the "-" keypad. The temperature will now be displayed in Centigrade (°C). Repeat the procedure to change the temperature mode back to Fahrenheit (°F).



Control lock (Single and Dual Zone):

The control panel can be locked to avoid unintentional changes. To lock the control, press and hold the "Lock" keypad until the display reads "Loc" then release your finger from the keypad. The lock icon will flash 3-times and then continuously illuminate. When the control panel is locked, only the Lock keypad, System Status OK indicator, and the Alarm indicator are active. To un-lock the control panel, repeat this instruction until the display reads "nLc".

Alarms (Single and Dual Zone):

The control will alert you to conditions that could adversely affect the performance of the appliance.



- **Door ajar** - If the door is open, or not closed properly, for more than 5-minutes the System Status OK indicator will turn-off, the "Door Ajar" indicator will flash, and a tone will sound every 60 seconds. Additionally, an "ALARM RESET" indicator will be displayed below the "On/Off" keypad. This alarm condition can be reset by closing the door or momentarily pressing the "On/Off" keypad, (i.e.-if you are cleaning the storage compartment, etc.). The alarm will recur in 5-minutes if the alarm condition persists.



- **Power failure** - If power to the appliance is interrupted the System Status indicator will turn-off and the "Power Failure" indicator will flash. Additionally, an "ALARM RESET" indicator will be displayed below the "On/Off" keypad. No audible tone will sound. This alarm condition can be reset by momentarily pressing the "On/Off" keypad. If this alarm occurs, it is recommended that you check the condition of any perishables, even if the appliance is operating normally and the temperature has recovered, as prolonged power outages could result in excessive temperature excursions which may spoil perishables.



- **Temperature alarm** - If the storage compartment temperature exceeds 10°F from set-point for more than a 1-hour duration, the System Status indicator will turn off, the "Temp" indicator will flash, and an audible tone will sound every 60-seconds. Additionally, an "ALARM RESET" indicator will be displayed below the "On/Off" keypad. This alarm condition can be reset by momentarily pressing the "On/Off" keypad. If this alarm occurs it is recommended that you check the condition of your stored contents, even though the appliance is operating normally and the temperature has recovered, as prolonged temperature excursions could spoil perishables.

NOTE

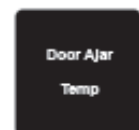

Multiple alarms are possible, i.e.- "Door Ajar" for a prolonged period may trigger a "Temp" alarm, in which case both "Door Ajar" and "Temp" indicators will activate.

Vacation mode (Single and Dual Zone):

This operating mode can be used to save energy during high cost energy periods, or when you won't be using your appliance for an extended period of time by disabling the lights, alarm tones, and keypad entry tones. Vacation mode also serves as a Sabbath mode, disabling functions and its controls in accordance with the weekly Sabbath and religious holidays observed within the Orthodox Jewish community. When used as Sabbath mode, you may open or close the door at any time to access contents without concern of directly turning on or off any lights, digital read-outs, solenoids, fans, valves, compressor, icons, tones, or alarms.

When activated, the display, alarm indicators and tones, keypad touch tones, interior lights, and all options are disabled. All keypad functions are disabled, with the exception of the "On/Off" keypad which is required to exit Vacation-mode. Storage compartment temperatures are monitored and controlled at the settings prior to entering Vacation mode.



To enter Vacation Mode (with the control out of sleep mode), press and hold the "On/Off" keypad until the display goes past "OFF" and reads "VAC". The display will flash "VAC" 3-times to acknowledge your request, then will display "VAC" continuously until Vacation mode is exited. A power outage will not exit Vacation mode, exiting can only be accomplished manually. To exit Vacation mode and return to normal operation, press and hold the "On/Off" keypad until the control displays the temperature.

5.5 User Interface Navigation – Refrigerated Drawers



Figure 10
Electronic single zone control



To wake the display press any keypad. A confirm tone will sound, and the current storage compartment temperature will be displayed.

Starting your appliance:

Plug the appliance power cord into a 115 volt wall outlet. Your appliance is shipped from the factory in the "On" position and will begin start-up of cooling as soon as power is supplied. If the appliance does not start, confirm that the wall outlet has power, and that the control is in the "On" position, (See "Turning your appliance On and Off" below).

The control display is covered with a clear plastic film. This film may be removed by carefully lifting the film at a corner.

On initial power up, the control display will indicate a "Power Failure" alarm. This is a normal condition as the appliance was powered-up at the factory for quality inspection and then removed from power. A momentary press of the "On/Off" keypad will reset this alarm condition. (See Alarms section on page 40).



The sleep mode can be disabled if you prefer to have the display on continuously. Press and hold the "Lock" keypad until the display goes past "Loc" and reads "nSL". To enable the sleep mode, repeat the instruction, again going past "Loc" until the display reads "SLP".

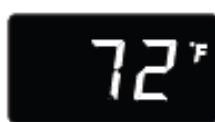

Sleep mode:

If no keypads are pressed for 60 seconds, the display will enter sleep mode to conserve power. The control panel will go dark with the exception of the system status "OK" indicator which will remain enabled. Alarm conditions will wake the display, (see alarms on page 40).

To make the following changes to the control settings (turning the appliance ON/OFF, adjusting the temperature, and activating vacation mode), the control must be awake.

Turning your appliance ON and OFF:

If the appliance is "On", (and out of sleep mode) the temperature will be shown in the display area of the control. To turn the appliance "Off", press and hold the "On/Off" keypad for 4-seconds. "OFF" will now be displayed on the control.



To turn the appliance "On", press and hold the "On/Off" keypad for 4-seconds.



Adjusting the temperature:

To set or check the set-point temperature (with the control out of sleep mode), press the "-" or "+" keypads. "SET" will be indicated on the user interface panel and the current set-point temperature will display and flash. Subsequent presses of the "-" or "+" keypads will adjust the temperature colder or warmer respectively. When you have reached your desired set-point temperature, press the "On/Off" keypad to accept, or do nothing and the "Set" mode will time-out in 10-seconds accepting the displayed temperature as the new set-point.

The available set-point temperature range for your appliance is 34°F (1.2°C) to 42°F (5.7°C). If you attempt to adjust the temperature outside of this range you will receive an audible notification.

When initially loading your product with warm contents, it may take up to 48-hours for the storage compartment temperature to stabilize.

When making temperature set-point changes, it may take up to 24-hours for the stored contents to stabilize at your new set-point temperature.

Factors that affect the storage compartment stabilized temperature:

- Changes to temperature setting.
- Room temperature changes.
- Temperature of stored contents.
 - Loading warm contents.
 - Cold content load will delay the change to a warmer set-point temperature.
 - Warm content load will delay the change to a colder set-point temperature.
- Usage, (number and duration of the drawer openings).
- Installation of the appliance in direct sunlight or next to a heat source.



Temperature mode:

The temperature mode is preset from the factory in Fahrenheit (°F) but you have the option to change it to Centigrade (°C). To change the mode, press and hold the "-" keypad, while pressing the "+" keypad, then release the "-" keypad. The temperature will now be displayed in Centigrade (°C). Repeat the procedure to change the temperature mode back to Fahrenheit (°F).



Control lock:

The control panel can be locked to avoid unintentional changes. To lock the control, press and hold the "Lock" keypad until the display reads "Loc" then release your finger from the keypad. The lock icon will flash 3-times and then continuously illuminate. When the control panel is locked, only the Lock keypad, System Status OK indicator, and the Alarm indicator are active. To un-lock the control panel, repeat this instruction until the display reads "nLc".

Alarms:

The control will alert you to conditions that could adversely affect the performance of the appliance.

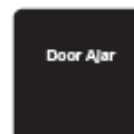

- **Door ajar** - If a drawer is open, or not closed properly, for more than 5-minutes the System Status OK indicator will turn-off, the "Door Ajar" indicator will flash, and a tone will sound every 60 seconds. Additionally, an "ALARM RESET" indicator will be displayed below the "On/Off" keypad. This alarm condition can be reset by closing the drawer or momentarily pressing the "On/Off" keypad, (i.e.-if you are cleaning the storage compartment, etc.). The alarm will recur in 5-minutes if the alarm condition persists.



- **Power failure** - If power to the appliance is interrupted the System Status indicator will turn-off and the "Power Failure" indicator will flash. Additionally, an "ALARM RESET" indicator will be displayed below the "On/Off" keypad. No audible tone will sound. This alarm condition can be reset by momentarily pressing the "On/Off" keypad. If this alarm occurs, it is recommended that you check the condition of any perishables, even if the appliance is operating normally and the temperature has recovered, as prolonged power outages could result in excessive temperature excursions which may spoil perishables.



- **Temperature alarm** - If the storage compartment temperature exceeds 10°F from set-point for more than a 1-hour duration, the System Status indicator will turn off, the "Temp" indicator will flash, and an audible tone will sound every 60-seconds. Additionally, an "ALARM RESET" indicator will be displayed below the "On/Off" keypad. This alarm condition can be reset by momentarily pressing the "On/Off" keypad. If this alarm occurs it is recommended that you check the condition of your stored contents, even though the appliance is operating normally and the temperature has recovered, as prolonged temperature excursions could spoil perishables.

NOTE



Multiple alarms are possible, i.e.- "Door Ajar" for a prolonged period may trigger a "Temp" alarm, in which case both "Door Ajar" and "Temp" indicators will activate.

Vacation mode:

This operating mode can be used to save energy during high cost energy periods, or when you won't be using your appliance for an extended period of time by disabling the lights, alarm tones, and keypad entry tones. Vacation mode also serves as a Sabbath mode, disabling functions and its controls in accordance with the weekly Sabbath and religious holidays observed within the Orthodox Jewish community. When used as Sabbath mode, you may open or close a drawer at any time to access contents without concern of directly turning on or off any lights, digital read-outs, solenoids, fans, valves, compressor, icons, tones, or alarms.

When activated, the display, alarm indicators and tones, keypad touch tones, interior lights, and all options are disabled. All keypad functions are disabled, with the exception of the "On/Off" keypad which is required to exit Vacation-mode. Storage compartment temperatures are monitored and controlled at the settings prior to entering Vacation mode.



To enter Vacation Mode (with the control out of sleep mode), press and hold the "On/Off" keypad until the display goes past "OFF" and reads "VAC". The display will flash "VAC" 3-times to acknowledge your request, then will display "VAC" continuously until Vacation mode is exited. A power outage will not exit Vacation mode, exiting can only be accomplished manually. To exit Vacation mode and return to normal operation, press and hold the "On/Off" keypad until the control displays the temperature.

5.5 User Interface Navigation – Beer Dispenser



Figure 13 Electronic single zone control



Power Failure



ALARM RESET

Starting your appliance:

Plug the appliance power cord into a 115 volt wall outlet. Your appliance is shipped from the factory in the "On" position and will begin start-up of cooling as soon as power is supplied. If the appliance does not start, confirm that the wall outlet has power, and that the control is in the "On" position, (See "Turning your appliance On and Off" below).

The control display is covered with a clear plastic film. This film may be removed by carefully lifting the film at a corner.

On initial power up, the control display will indicate a "Power Failure" alarm. This is a normal condition as the appliance was powered-up at the factory for quality inspection and then removed from power. A momentary press of the "On/Off" keypad will reset this alarm condition. (See Alarms section on page 43).

To wake the display press any keypad. A confirm tone will sound, and the current storage compartment temperature will be displayed.



The sleep mode can be disabled if you prefer to have the display on continuously. Press and hold the "Lock" keypad until the display goes past "Loc" and reads "nSL". To enable the sleep mode, repeat the instruction, again going past "Loc" until the display reads "SLP".



Sleep mode:

If no keypads are pressed for 60 seconds, the display will enter sleep mode to conserve power. The control panel will go dark with the exception of the system status "OK" indicator which will remain enabled. Alarm conditions will wake the display, (see alarms on page 43).

To make the following changes to the control settings (turning the appliance ON/OFF, adjusting the temperature, and activating vacation mode), the control must be awake.

Turning your appliance ON and OFF:

If the appliance is "On", (and out of sleep mode) the temperature will be shown in the display area of the control. To turn the appliance "Off", press and hold the "On/Off" keypad for 4-seconds. "OFF" will now be displayed on the control.



To turn the appliance "On", press and hold the "On/Off" keypad for 4-seconds.



Adjusting the temperature:

To set or check the set-point temperature (with the control out of sleep mode), press the "-" or "+" keypads. "SET" will be indicated on the user interface panel and the current set-point temperature will display and flash. Subsequent presses of the "-" or "+" keypads will adjust the temperature colder or warmer respectively. When you have reached your desired set-point temperature, press the "On/Off" keypad to accept, or do nothing and the "Set" mode will time-out in 10-seconds accepting the displayed temperature as the new set-point.

The available set-point temperature range for your appliance is 34°F (1.2°C) to 46°F (7.9°C). If you attempt to adjust the temperature outside of this range you will receive an audible notification.



If you are using the appliance as a refrigerator for perishable foods, the set-point temperature should be set between 34°F and 42°F (1.2°C and 5.7°C).

When initially loading your product with warm contents, it may take up to 48-hours for the storage compartment temperature to stabilize.

When making temperature set-point changes, it may take up to 24-hours for the stored contents to stabilize at your new set-point temperature.

Factors that affect the storage compartment stabilized temperature:

- Changes to temperature setting.
- Room temperature changes.
- Temperature of stored contents.
 - Loading warm contents.
 - Cold content load will delay the change to a warmer set-point temperature.
 - Warm content load will delay the change to a colder set-point temperature.
- Usage, (number and duration of the door openings).
- Installation of the appliance in direct sunlight or next to a heat source.



Temperature mode:

The temperature mode is preset from the factory in Fahrenheit (°F) but you have the option to change it to Centigrade (°C). To change the mode, press and hold the "-" keypad, while pressing the "+" keypad, then release the "-" keypad. The temperature will now be displayed in Centigrade (°C). Repeat the procedure to change the temperature mode back to Fahrenheit (°F).



Control lock:

The control panel can be locked to avoid unintentional changes. To lock the control, press and hold the "Lock" keypad until the display reads "Loc" then release your finger from the keypad. The lock icon will flash 3-times and then continuously illuminate. When the control panel is locked, only the Lock keypad, System Status OK indicator, and the Alarm indicator are active. To un-lock the control panel, repeat this instruction until the display reads "nLc".

Alarms:

The control will alert you to conditions that could adversely affect the performance of the appliance.



- **Door ajar** - If the door is open, or not closed properly, for more than 5-minutes the System Status OK indicator will turn-off, the "Door Ajar" indicator will flash, and a tone will sound every 60 seconds. Additionally, an "ALARM RESET" indicator will be displayed below the "On/Off" keypad. This alarm condition can be reset by closing the door or momentarily pressing the "On/Off" keypad, (i.e.-if you are cleaning the storage compartment, etc.). The alarm will recur in 5-minutes if the alarm condition persists.



- **Power failure** - If power to the appliance is interrupted the System Status indicator will turn-off and the "Power Failure" indicator will flash. Additionally, an "ALARM RESET" indicator will be displayed below the "On/Off" keypad. No audible tone will sound. This alarm condition can be reset by momentarily pressing the "On/Off" keypad. If this alarm occurs, it is recommended that you check the condition of any perishables, even if the appliance is operating normally and the temperature has recovered, as prolonged power outages could result in excessive temperature excursions which may spoil perishables.



- **Temperature alarm** - If the storage compartment temperature exceeds 10°F from set-point for more than a 1-hour duration, the System Status indicator will turn off, the "Temp" indicator will flash, and an audible tone will sound every 60-seconds. Additionally, an "ALARM RESET" indicator will be displayed below the "On/Off" keypad. This alarm condition can be reset by momentarily pressing the "On/Off" keypad. If this alarm occurs it is recommended that you check the condition of your stored contents, even though the appliance is operating normally and the temperature has recovered, as prolonged temperature excursions could spoil perishables.

NOTE



Multiple alarms are possible, i.e.- "Door Ajar" for a prolonged period may trigger a "Temp" alarm, in which case both "Door Ajar" and "Temp" indicators will activate.

Vacation mode:

This operating mode can be used to save energy during high cost energy periods, or when you won't be using your appliance for an extended period of time by disabling the lights, alarm tones, and keypad entry tones. Vacation mode also serves as a Sabbath mode, disabling functions and its controls in accordance with the weekly Sabbath and religious holidays observed within the Orthodox Jewish community. When used as Sabbath mode, you may open or close the door at any time to access contents without concern of directly turning on or off any lights, digital read-outs, solenoids, fans, valves, compressor, icons, tones, or alarms.

When activated, the display, alarm indicators and tones, keypad touch tones, interior lights, and all options are disabled. All keypad functions are disabled, with the exception of the "On/Off" keypad which is required to exit Vacation-mode. Storage compartment temperatures are monitored and controlled at the settings prior to entering Vacation mode.



To enter Vacation Mode (with the control out of sleep mode), press and hold the "On/Off" keypad until the display goes past "OFF" and reads "VAC". The display will flash "VAC" 3-times to acknowledge your request, then will display "VAC" continuously until Vacation mode is exited. A power outage will not exit Vacation mode, exiting can only be accomplished manually. To exit Vacation mode and return to normal operation, press and hold the "On/Off" keypad until the control displays the temperature.



SECTION 6: Control System

6.1 User Interface Display

The user interface display is mounted to the door top and connected to the main power board by means of a communication cable. The cable extends through the door and exits at the bottom hinge location.



6.1.1 Removing the User Interface Display

CAUTION

It is recommended that a grounding strap be used when working with any solid state control board application.

CAUTION

Care must be taken as a damaged wire or connector downstream from the display disconnect connector cannot be repaired or replaced. The Display receiver and wiring harness are foamed in place. Any damage will result in a door replacement.

1. Use the bottom edge of both thumb nails to gently pry up on the left hand side of the display. **(DO NOT use a sharp object such as a jack knife, putty knife, or screwdriver. Objects like these can destroy the appearance of the display or scratch the door).**
2. Once the display is unseated, turn over and locate the display connector.
3. Using your thumb or fore finger to unsnap the lock.
4. Separate the connector and set the display aside.



Place finger nails under left hand lip of user interface display.



Lift upwards.

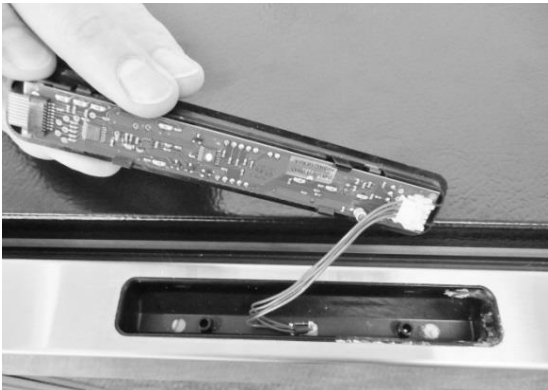

Lift user interface away from door receiver.



Release locking tab on display connector.



The user interface can now be removed.

User Interface PCA	
Terminal	Description
J1	Com Cable to Main Board
J2	ICON / Key Switch

6.1.2 Installing a new User Interface Display

1. Reverse the process used to remove the display board.
 2. Carefully place the display back into the door receiver.
- Apply a light downward pressure to the edge of the display to snap into place

EXPLODED VIEW of User Interface Assembly

ICON/Key Switch Assembly



UI Carrier

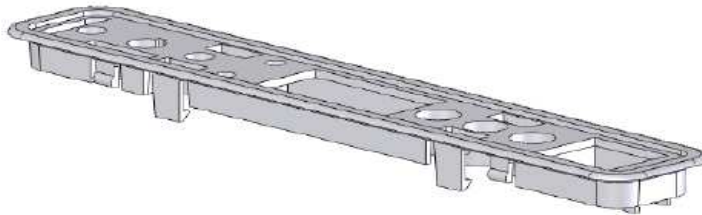

UI PCA

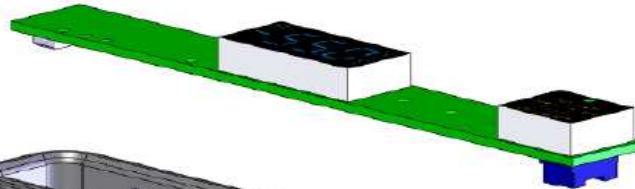

UI Receiver (foamed in)

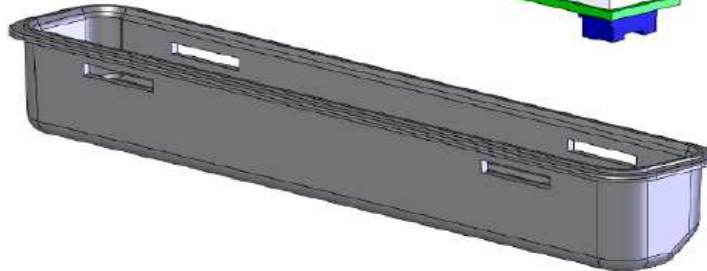

6.2: Main Control Board

WARNING

Prior to removing the access cover to the machine compartment, disconnect the supply voltage to the appliance; failure to do this could result in an electrical shock or possible death.

CAUTION

It is recommended that a grounding strap be used when working with any solid state control board application.

6.2.1: Control Board Replacement

1. The main power board is located at the bottom rear, left hand corner of the machine compartment.
2. To replace the board, remove the Phillips head screw securing the mounting bracket to the machine compartment.
3. For ease of access, lower the leveling leg so that the threaded section is lower than its threaded bushing.
4. Remove both large connectors on the bottom left hand side of the control board. Press the release and pull each connector off its terminal.
5. The board can now be lifted out of the machine compartment.
6. The main board mounting bracket and the machine compartment bottom are manufactured for a positive fit upon installation.
 - a. The control bracket has a notched recess on the bottom rear of the bracket.
 - b. The machine compartment bottom has a slotted tab to facilitate the recess of the control mounting bracket when installed.
7. Each wiring harness at the board is labeled as to its corresponding location on the board. Prior to removing any harness, double check to insure that the identification on each harness is legible for correct placement when repair is completed.
8. The control board terminals are also marked as to the correct harness locations.

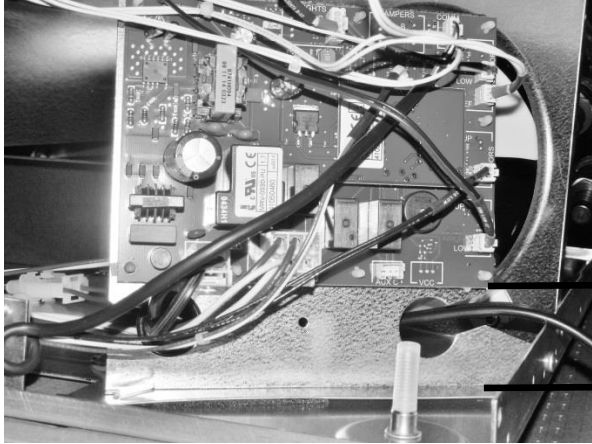

The photo to the left shows the new modified board bracket to extend the mounting height farther away from the cabinet base.

Location of the main power board.

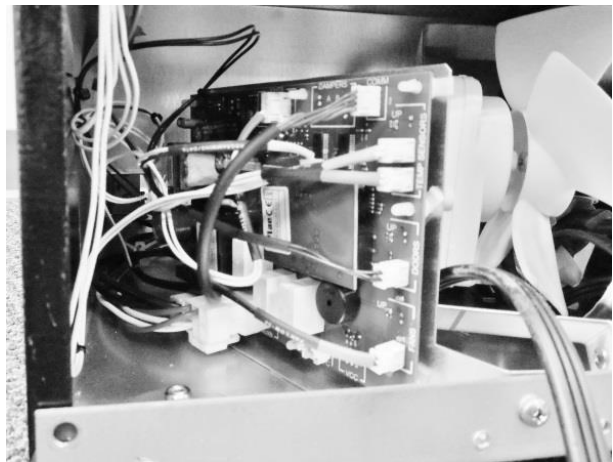

Remove screw holding the control board bracket in place.

Disconnecting the two large connectors.

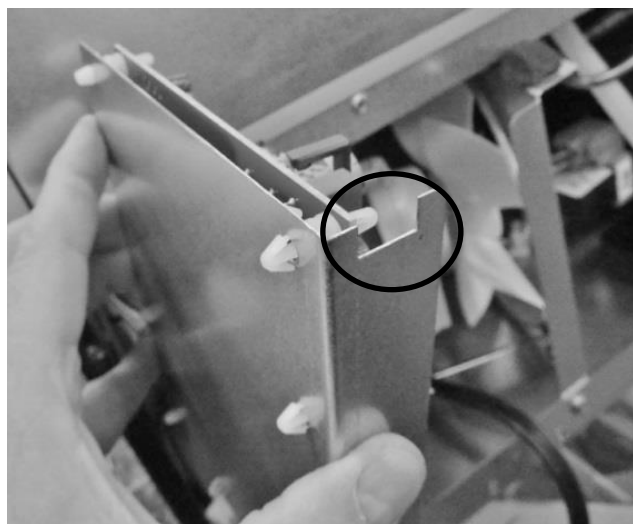
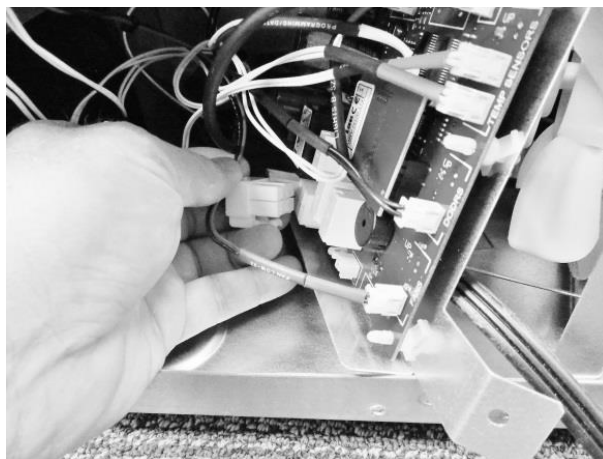

Recess on the bottom of the mounting bracket.

Slotted tab on the bottom of the machine compartment.

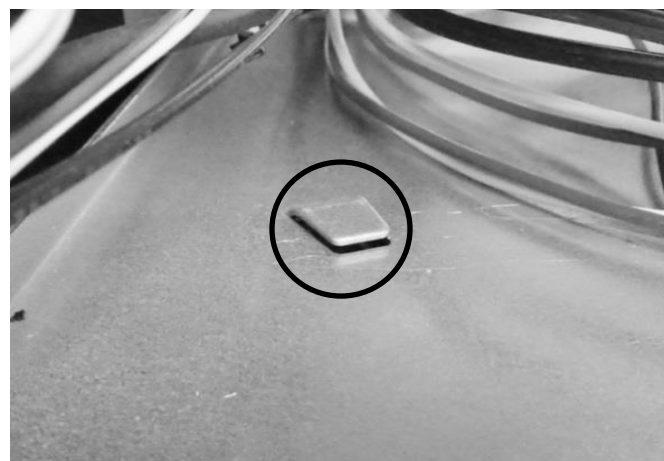

NOTE: For wiring diagrams please refer to: Section 9, Wiring Diagrams.

The following pictures represent terminal identification on a single zone main power board.

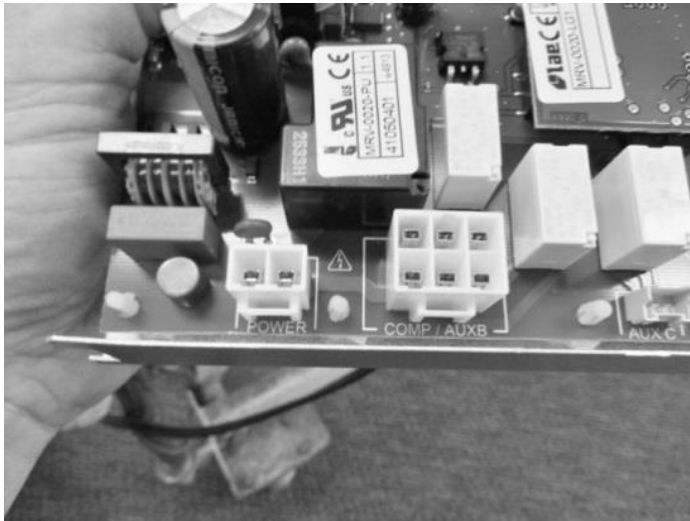

**Connectors J1 – J9: See Wiring,
Section 9.1**

**Connectors J4 – J14: See
Wiring, Section 9.1**

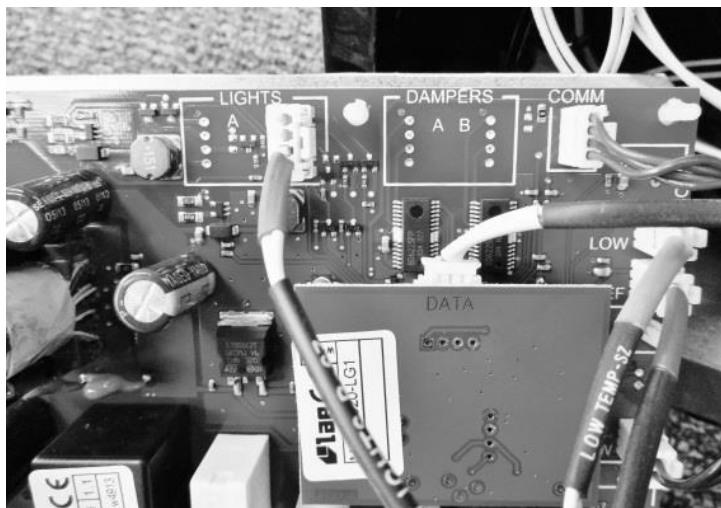
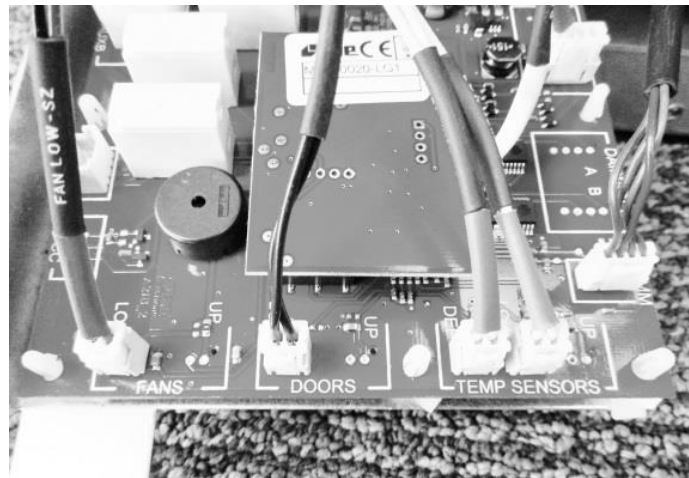

**Connectors J5 & J15b: See
Wiring, Section 9.1**

6.2.2: Removing the Programming / Data cable

Care must be taken when removing this cable. The cable is located between the main board and the small 2" x 2" programming board. It is not recommended to use a metal tool to unsnap the cable connector. Use of a metal tool could result in a static discharge or accidental damage to the board.

1. The program board is connected to the main board by a row of pins on each side of the board.
2. Grasp the program board on each side with your thumb and forefinger. Carefully pull the program board out and away from the main board.
3. The data / programming cable can now be unsnapped and disconnected.

6.2.3: Re-Installing the Programming / Data cable

1. Carefully replace the data / programming cable back into the connection on the program board.
2. Once again with care, align the pins on each side of the program board to re-adjoin with the connections on the main power board.

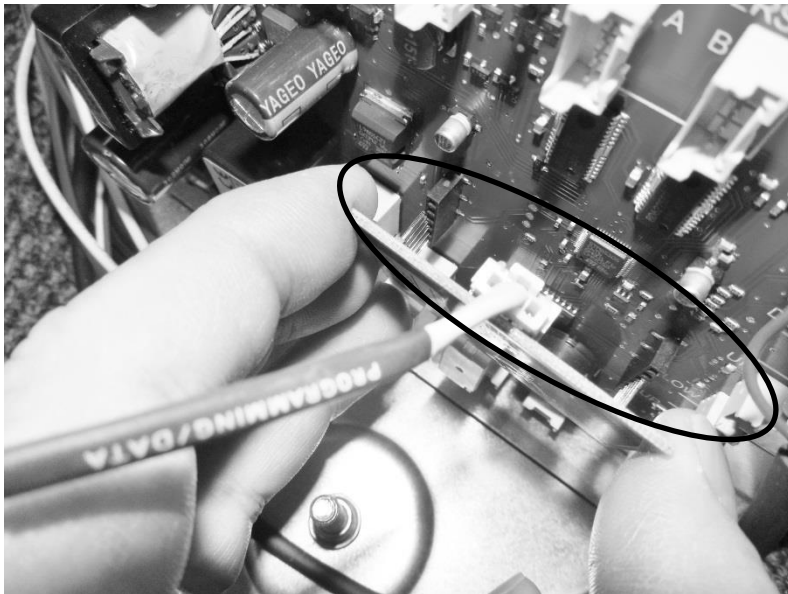

**Connector J16: See
Wiring, Section 9.1**

6.2.4: Control Board Installation

1. Replace the two connectors, previously removed, to the correct location on the main board.
2. Prior to reinstalling the power board locate the slotted tab on the bottom of the machine compartment.
3. Next locate the notched recess on the bottom of the control bracket.
4. Upon assembly, the notched recess on the control bottom needs to slide into the slotted tab on the machine compartment.
5. Reattach the assembly to the rear machine compartment flange with the screw previously removed.

Return the leveling leg to its correct position.

6.3: Cabinet and Defrost Thermistors



Prior to removing the access cover to the machine compartment, disconnect the supply voltage to the appliance; failure to do this could result in an electrical shock or possible death.

6.3.1 Thermistor (Sensor)

The control thermistor senses the interior temperature allowing the control to adjust and properly display the interior temperature. The thermistor is located at the mid, left hand wall. The thermistor is covered with a plastic shield to prevent accidental damage.

The thermistor can be checked by use of a multi-meter with the ability to read resistance. Refer to the resistance chart.

6.3.2: Check the Thermistor:

The main cabinet and defrost thermistor harnesses from the control board are foamed in place. The recommended method to ohm the thermistor is to remove the thermistor connector at the control board and take the reading.

For thermistor replacement; the cabinet thermistor connector is located in front of the evaporator cover, the defrost thermistor connector is located behind the cover.

6.3.3: Removing the Cabinet Thermistor

1. Remove interior shelving for ease of access.
2. Remove the decorative caps and screws from the thermistor shield.
3. Remove cantilever shelving brackets if applicable.
4. Disconnect the bad thermistor at the connector plug and remove.
5. For refrigerated drawers:
 - Remove both top and bottom drawers. See “section 7.4.1” regarding drawer removal.

6.3.4: Installing the Cabinet Thermistor

1. Snap the new thermistor into the other half of the connector.
2. Place the new thermistor into its protective shield. The underneath side of the shield is fitted to accommodate the grooves on the thermistor bulb.
3. Replace all components in the reverse order they were removed.

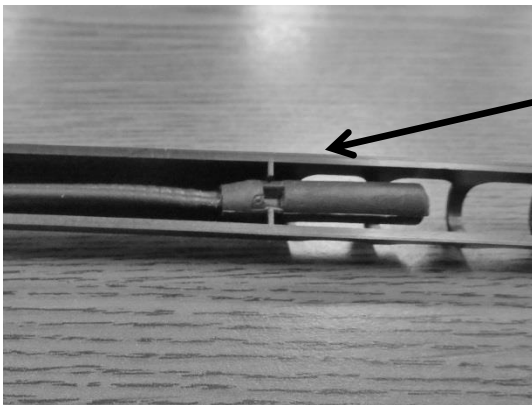

Cabinet Thermistor: Note the locator slot inside the thermistor shield. The grooved thermistor bulb fits firmly in the seat created inside the shield.

6.3.5: Removing the Defrost Thermistor

1. Remove all interior shelving.
2. Remove cantilever shelving brackets if applicable.
3. Remove decorative screw caps and screws from evaporator coil cover.
4. Disconnect fan.
5. Remove evaporator coil cover.
6. Cut the two nylon zip ties holding the thermistor to the evaporator plate.
7. Disconnect the bad thermistor at the connector plug and remove.

6.3.6: Installing the Defrost Thermistor

1. Snap the new thermistor into the other half of the connector.
2. Secure the thermistor on the evaporator plate using the two nylon zip ties included in the kit. Insure that the thermistor is mounted with the bulb facing the left hand side of the liner; pull the zip ties firmly for proper plate sense.
3. Replace all components in the reverse order they were removed.



Basic Evaporator
Configuration: All Models:
Evaporator cover removed.

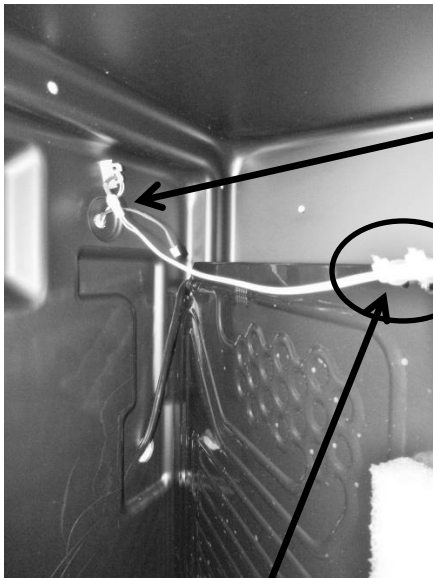

Defrost Sensor
Location.

Defrost Sensor Disconnect.

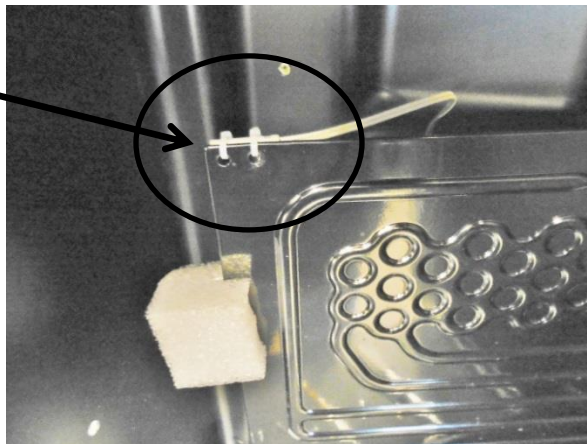
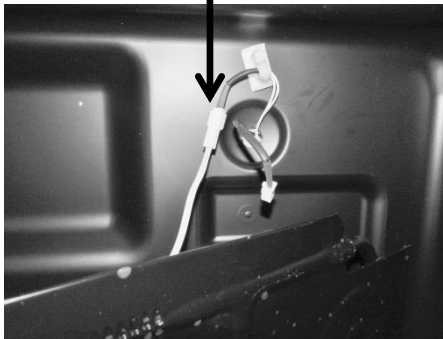

Cabinet Sensor Location:
Typical on all models.

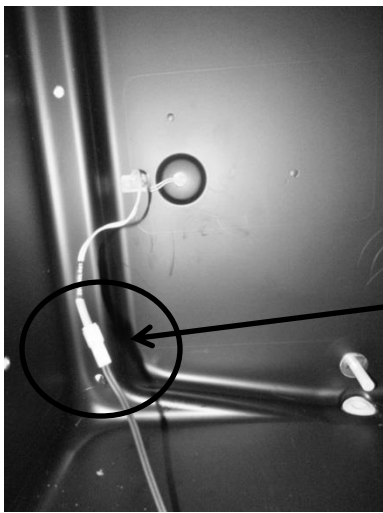

Cabinet sensor connector.

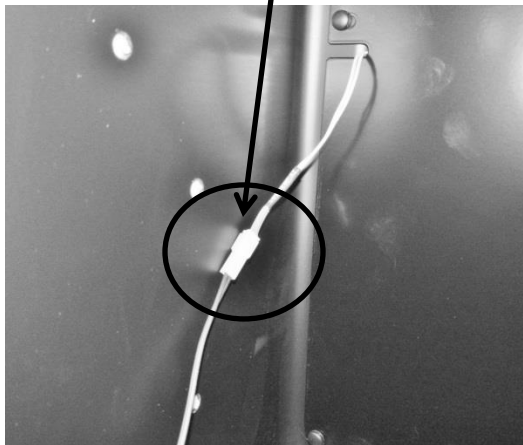

6.3.7: Thermistor Harness Identification:

1. Cabinet sensor, (orange) labeled: *"Low Temp"*.
2. Defrost sensor, (red) labeled: *"Defrost Evap"*.

6.4: Temperature Resistance Chart

TEMPERATURE		RESISTANCE	TEMPERATURE		RESISTANCE
C°	F°	k ohm	C°	F°	k ohm
-18	0	61.941	15	59	14.675
-17	1	59.032	18	64	13.05
-16	3	56.277	19	66	12.555
-15	5	53.667	20	68	12.081
-14	7	51.194	21	70	11.628
-13	9	48.85	22	72	11.195
-12	10	46.627	23	73	10.78
-11	12	44.519	24	75	10.382
-10	14	42.518	25	77	10
-9	16	40.611	26	79	9.634
-8	18	38.801	27	81	9.283
-7	19	37.082	28	82	8.947
-6	21	35.451	29	84	8.624
-5	23	33.9	30	86	8.314
-4	25	32.427	31	88	8.018
-3	27	31.027	32	90	7.733
-2	28	29.695	33	91	7.46
-1	30	28.429	34	93	71.99
0	32	27.224	35	95	6.947
1	34	26.081	36	97	6.706
2	36	24.992	37	99	6.475
3	37	23.955	38	100	6.252
4	39	22.967	39	102	6.038
5	41	22.025	40	104	5.833
6	43	21.126	41	106	5.635
7	45	20.269	42	108	5.445
8	46	19.452	43	109	5.262
9	48	18.672	44	111	5.086
10	50	17.928	45	113	4.916
11	52	17.216	46	115	4.753
12	54	16.536	47	117	4.596
13	55	15.887	48	118	4.445
14	57	15.267	49	120	4.3



6.5: Door Sensor

On beverage center and wine cooler models, the door sensor is located on the bottom cabinet flange; approximately one third of the distance away from the handle side of the cabinet. The refrigerated drawers do not use this technology, dual rocker switches are used for drawer models.

The door sensor is resistance activated by the pressure of the door gasket. Light functionality and the door alarm are directly related to this switch.

NOTE: Refer to Section 19 for a Service Bulletin regarding a door sensor "DO" alarm.

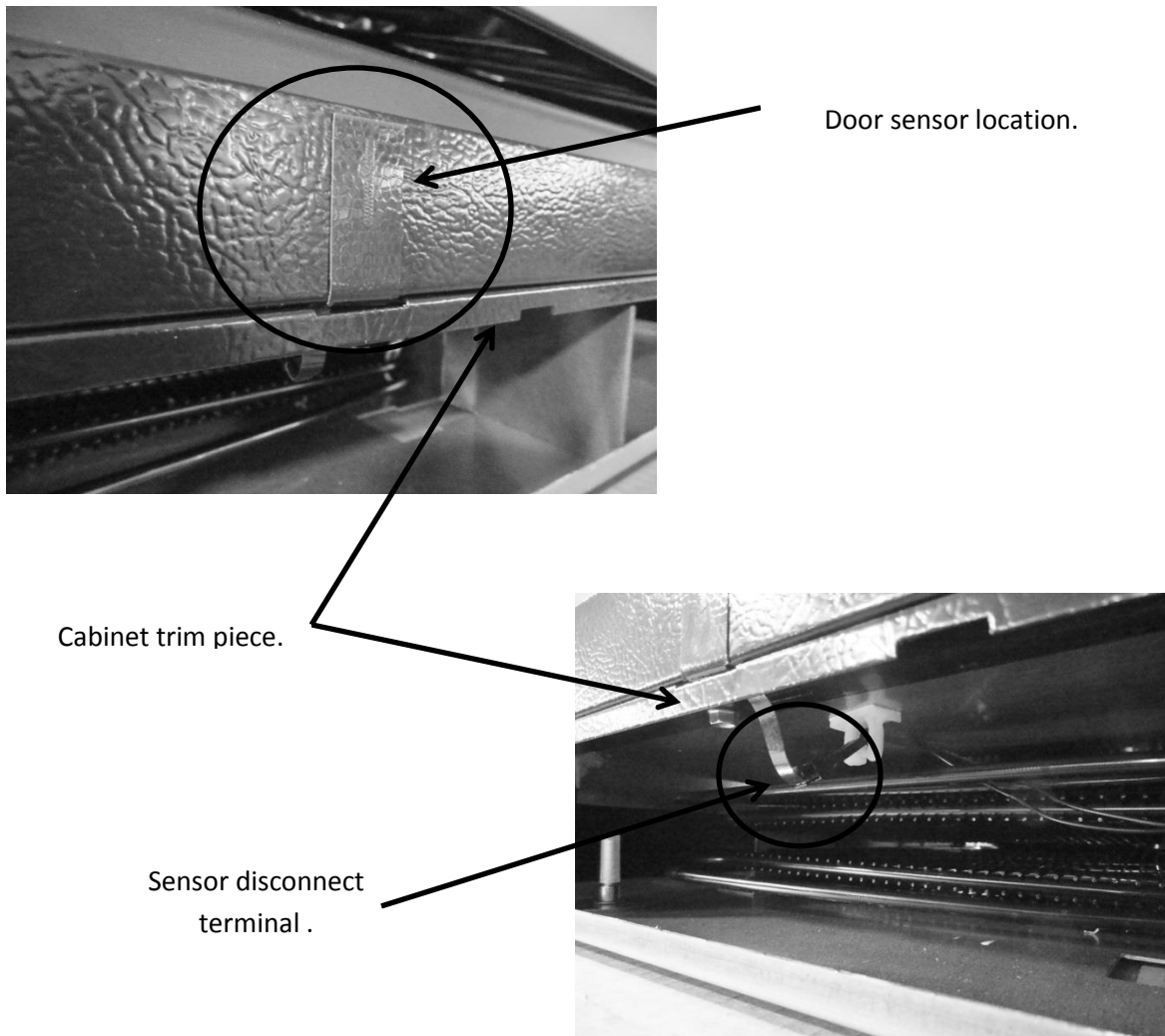

6.5.1: Door Sensor Removal

1. Remove the toe grill.
2. Disconnect the door sensor at the harness terminal behind the trim piece. See photo.
3. Remove the door sensor from the cabinet by starting in one of the upper corners and peeling in a downward motion.
4. Once the sensor has been removed from the flange area:
 - a. Grasp the sensor with the right hand using the thumb and forefinger.
 - b. Grasp the electrical strip portion of the sensor between the thumb and forefinger on the right hand.
5. Slowly work the sensor through the gap on the lower trim section to remove. The upper portion of the electrical strip has some adhesive backing so care is advised.

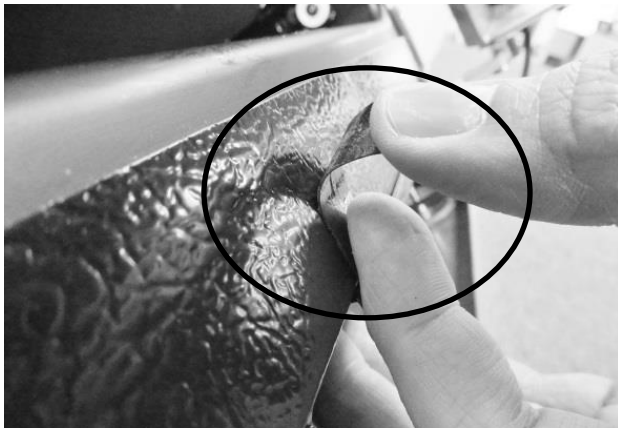

Peel away from cabinet flange.

SERVICE BULLETIN 41013995:

Addresses issues with poor door to switch contact. Available service kits are: S41050470-BLK, S41050470-WHT, and S41050470-SS.

Refer to “Service Bulletin Section” in this manual.



Sensor removed.

6.5.2: Door Sensor Replacement

1. Do not remove the adhesive backing from sensor until it is in place.
2. Slide the new sensor into the gap between the bottom flange and trim piece.
3. Once the sensor is in place:
 - a. Remove the adhesive backer from sensor.
 - b. Ensure the sensor is in position and carefully adhere to the cabinet. Apply carefully using thumb pressure to the outer perimeter of the door sensor.
 - c. **NOTE:** *Care should be taken not to apply unnecessary pressure directly on the raised vertical center of the sensor face. The switch is pressure sensitive; any undue pressure could damage the sensor.*

6.6: Defrost Modes

6.6.1: Defrost Characteristics

1. Defrost is achieved as the result of compressor off time. No electrical or mechanical alternatives are used.
2. Time defrost: Is initiated every 6 hours of compressor run time.
3. The evaporator fan is on for the entire defrost period.
4. Defrost is active for either a period up to 40 minutes of compressor off time or until the defrost thermistor senses 40°F at its evaporator location.
5. Drip time: The compressor will have an additional 2 minute lag time (30 minutes for a dual zone) prior to restarting after the conclusion of the defrost cycle. This allows remaining moisture to drip off the evaporator plate.
6. A manual defrost can be initiated with a two key operation explained in Section 6.6.3

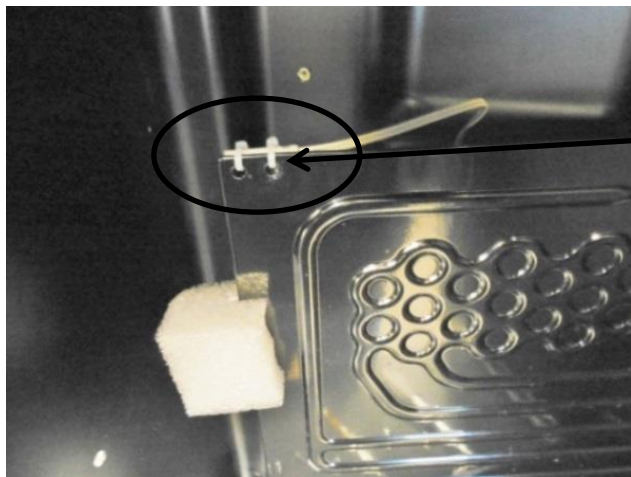

Location of the defrost thermistor: Top left hand corner of evaporator plate.

6.6.2 Auto Defrost

- **Drip Time Reference: Dual Zone has been extended to 30 minutes.**

Defrost is achieved as the result of compressor off time. NO electrical or mechanical alternatives are used.

Timed Defrost: is initiated every 6 hours of compressor run time.

The evaporator fan is on for the entire defrost cycle.

Defrost is active for a period up to 40 minutes of compressor off time.

The defrost thermistor will terminate defrost @ 40°F at its evaporator location.

The defrost will terminate when either condition is achieved prior to the other

Drip Time: The compressor will have an additional 2 minutes (30 for a dual zone) of lag time prior to restarting after the conclusion of the defrost cycle. This allows the moisture to drip off the evaporator plate.

Defrost Time Out periods edited on page 64



Defrost Time Out (DTO) is the total time of compressor off time; including both defrost and drip time cycles.

AS OF 8/1/15 THE FOLLOWING CHANGES WERE MADE TO THE DEFROST TIME OUT (DTO) ON THE FOLLOWING MODELS:

- **On all models except for the RF, RI, DZ and ML24WS; the DTO was expanded from 60 to 75 minutes.**
- **Model ML24WS was expanded from 40 to 75 minutes.**
- **RF, RI, and DZ models remain the same.**

6.6.3 Manual Defrost

A manual defrost can be activated by using the following sequence:

- Press the LOCK and MINUS key simultaneously and hold for 3 seconds.
- The display will flash dEF (defrost mode) three times before entering the defrost mode.
- dEF will be displayed for the duration of the defrost cycle.
- The defrost cycles will terminate when either of the following conditions are achieved first:
 - the defrost has been active for 40 minutes
 - the defrost thermistor reaches 40°F

6.7 Error Codes

With the Aurora control there are four error codes that could appear on the user interface display. They are as follows:

- EL : Compartment thermistor open or out of range
- Ed : Defrost thermistor open or out of range
- EL / Ed : Multiple thermistor errors, open or out of range
- CE : Communication cable error, broken connector pin or wire

Section 7: Lights, Doors, Drawers, and Hinges

7.1 LED Lighting

1. **Refrigerated Drawers:** are equipped with two LED lights. The upper LED is located on the ceiling of the cabinet, while the lower LED is located on the underside of the mullion assembly. These lights are controlled by the opening and closing of the associated drawer. Each light is controlled by an independent rocker switch, which is located behind each drawer on the back wall of the cabinet.
2. **Beverage Centers:** Have two LED lights and are located on the right hand and left hand front of the cabinet ceiling.
3. **Wine Coolers:**
 - **Single Zone:** Have two LED lights which are located on the right hand and left hand front of the cabinet ceiling.
 - **Dual Zone:** Same as the single zone with two additional LED lights on the center divider in like positions as the cabinet ceiling.

The LED lighting for beverage centers and wine coolers is controlled both by the light switch on the user interface display and also by the read switch mounted on the bottom flange of the cabinet. Pressure from the door gasket makes and breaks the read switch circuitry to control light function with door openings and closings.

Additional lighting features can be reviewed in the controls operation section in this manual.

7.1.1: Replacing the LED Light

1. Remove both Phillips screws in lens cover, the LED assembly can now be removed. (A refrigerated drawer mullion is used for reference in below photo).
2. Disconnect the connector plug to replace LED.
3. Reverse process to install.



**Refrigerated drawer mullion
shown in photo.**



**Refrigerated Drawer
Mullion.**

**Cabinet ceiling LED – all
models.**



7.2: Cabinet Door

7.2.1 Door Removal

- Remove both Phillips screws holding the toe grill in place; one on each end of the grill.
- Locate and disconnect the communication cable connector on the bottom of the door (hinge side).
- Remove the P-clamp securing the communication cable to the door bottom.

7.2.1.1 Marvel Models and non-Overlay door Models (Standard Hinge and Pin Assembly)

- Remove the upper door pin with a 1/8" Allen wrench.
- Lift the door off the bottom hinge pin.

7.2.1.2 Marvel Professional and Overlay Door Models (Articulating Hinge Assembly)

- Open the door and locate the 4 mounting screws holding the hinge to the cabinet flange face.
- Loosen both screws in the keyhole and slotted screw holes on the top and bottom hinges.
- Slide the door off the top and bottom hinges.
- **SEE SECTION 7.7 FOR ADDITIONAL INFORMATION**



Remove the toe grill.

NOTE: The communication cable is secured to the bottom of the door by the use of a p-clamp. It relieves in stress applied to the electrical disconnect.

Communication cable disconnect on the bottom of door. The p-clamp is mounted on a post to accommodate hinge clearance.



Disconnect communication connector and remove P-clamp and post.



Remove upper door pin.

7.2.2 Bottom Door Closer

The bottom door closer can be replaced by loosening the screws on both the lower cabinet flange and the underside of the door.

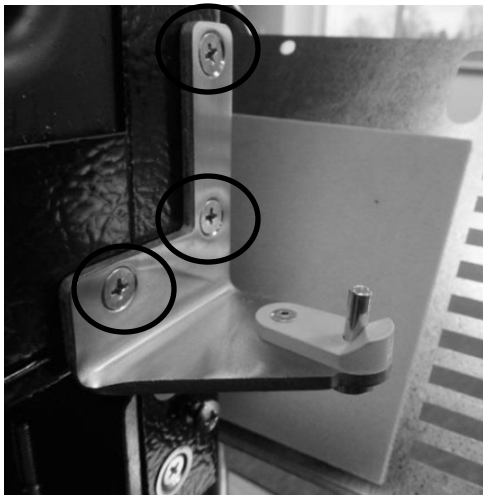

Remove screws to replace the door closer assembly.

7.3: Refrigerated Drawers

7.3.1: Drawer Removal

1. Disconnect user interface connection located at the top rear on the right hand side of the upper drawer. (No connections for bottom drawer).
2. Remove the screw on each on top front of each shelf rail (2 total).
3. Push the release rod forward; this will disengage the locking tab on the rear of each drawer rail.
4. The drawer can now be lifted and removed from the slide rails.

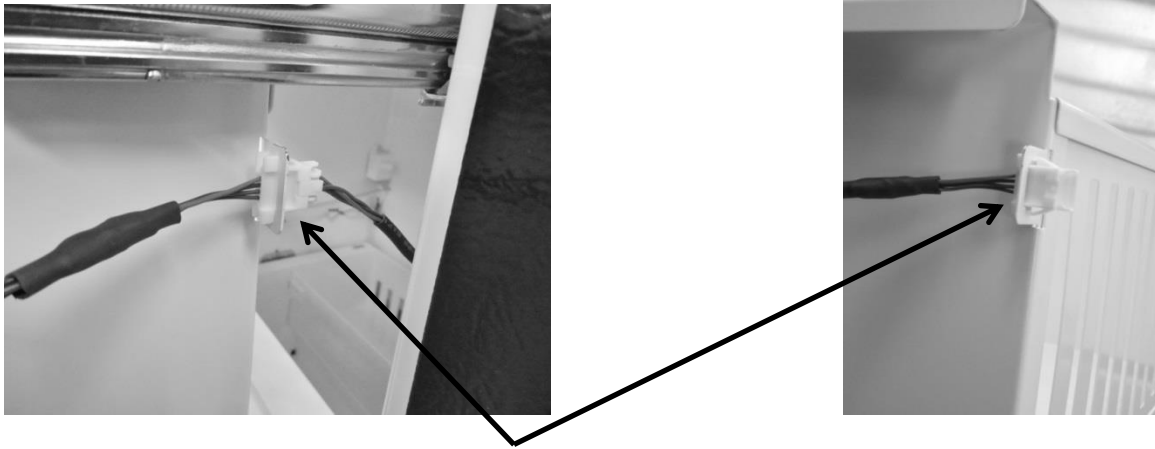

Disconnect communication cable at right rear of upper drawer.



Remove screw on each side of shelf rail.

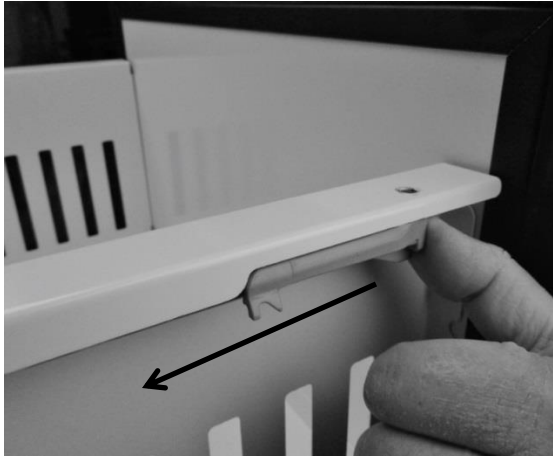

Push the gray drawer release, on each side, forward to unlock drawer tab.

Locking tab shown in secure position.



Drawer can now be lifted and removed.

7.4: Doors / Drawers Handle Adjustment



Both the door and drawer handles are secured with a 3/32" hex set screw, on the underside of each standoff.

3/32" hex head. Snug or loosen the set screw firm. Do not over tighten.

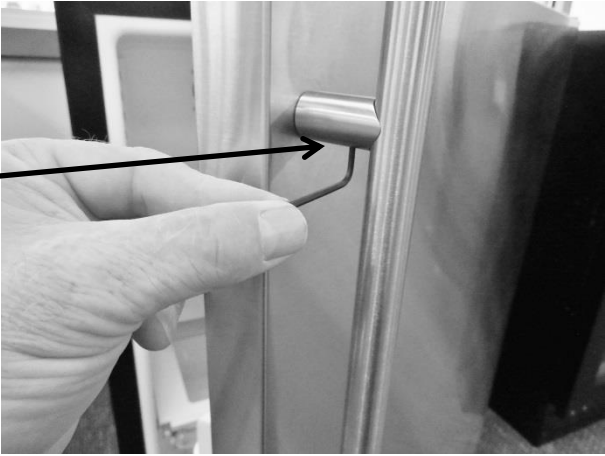

Once loosened, the handle can be pulled out of the standoff.





If the standoff is loose it can be tightened with a Phillips screwdriver.

The head of the Phillips screw inside the standoff. Turn the screw clockwise to tighten.



Replace handle stud into the standoff, turn clockwise with the Allen wrench, and snug hex screw finger tight.

7.5: Door Alignment /Adjustment:

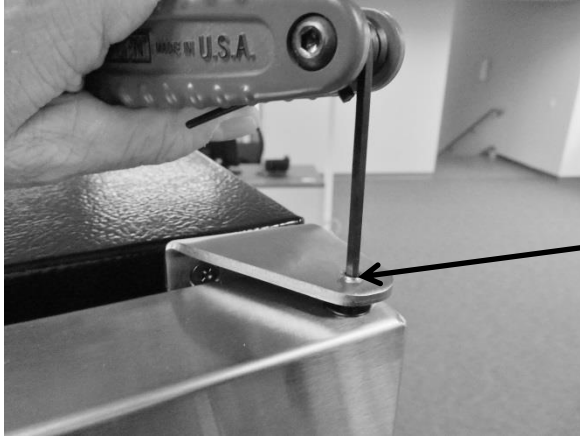

1/8" hex head. Turn the screw counterclockwise to remove.

5/32" hex head. To adjust, loosen both screws (counterclockwise) on the bottom of the door. Slide the bracket right, left or diagonally to some degree to adjust door alignment.



7.6: Gasket Adjust / Replace:



Press the gasket foot into the door channel to reseal. Use your thumb to work the gasket in place around the perimeter of the door.

NOTE: If adjustment, binding, rolling, or pinching occurs, use a hair dryer to restore the memory of the gasket to the cabinet flange.

7.7 Articulating Hinges:

Articulating hinges are standard on Marvel Professional and panel ready doors.

Professional and overlay door models cannot be installed free standing. Units with the **Articulating Hinge** must be installed as built-in due to safety constraints.



Panel ready door shown with articulating hinges.

NOTE: The top hinge is spring loaded and has the capability to suddenly close and severely pinching an appendage.



Open Top Hinge:
Outside View.

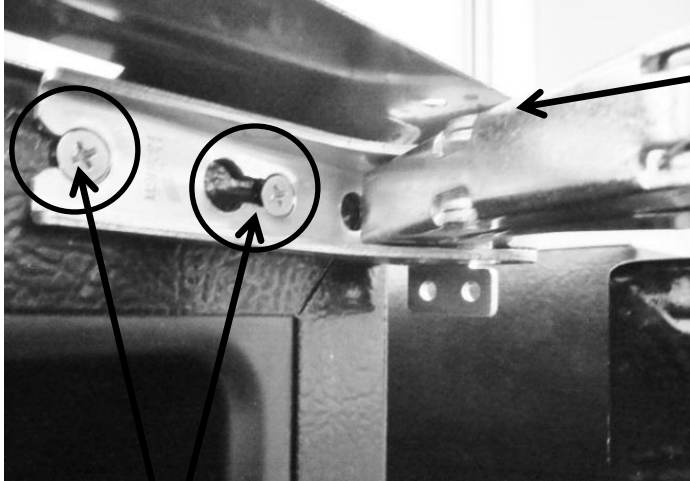

Open Top Hinge:
Inside View.

Loosen both screws, on top and bottom hinges to remove door.

NOTE: Use caution with both the top and bottom hinges as they have the capability of severely pinching an appendage.

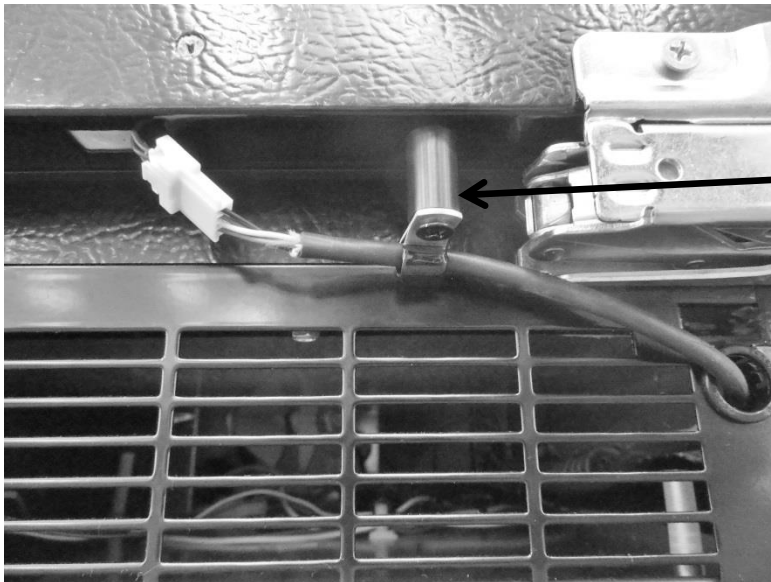

The cable post is used only on articulating hinge doors. Its purpose is to keep the communication cable from being pinched by the hinge. The p-clamp, post and harness connector must be detached from the door to accommodate door removal.

Section 8: Evaporator Compartment Access

To gain access to the evaporator compartment of the beverage center, wine cooler or refrigerated drawers are very similar but slightly unique.

After drawers or shelving have been removed, the decorative plastic snap caps will have to be removed to access screw removal for both the cantilever brackets, coil cover, and thermistor shield.

NOTE: Refrigerated Drawers: See Section 7.3.1: Drawer Removal for additional information.

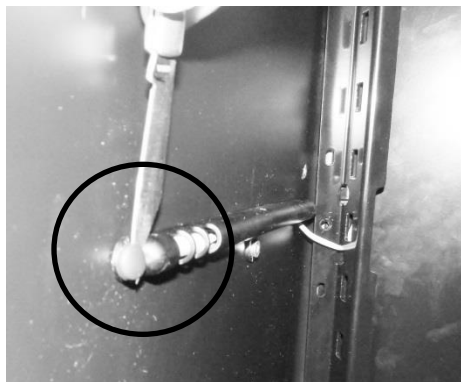

← A knife or small putty knife is used to pop each snap cap off the screw heads. Place the blade on the rear base of the cap and lightly pry upwards.

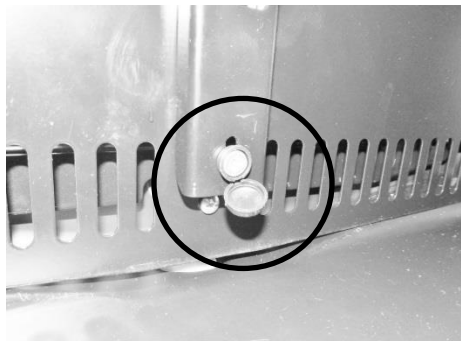

← Hinged screw cover. Location varies on Beverage Center and Wine Cooler.

8.1: Beverage Centers:

1. Remove all shelving
2. Remove both corner brackets and the center mounted bracket.
3. Remove decorative plastic snap caps.
4. The plastic cap located at the bottom of the center cantilever mounting rail is hinged on one side; it is slightly larger than the remaining plastic decorative snap caps. Remove screws around the perimeter of the coil cover.
5. Carefully remove the coil cover and disconnect the evaporator fan and thermistor wires as needed.

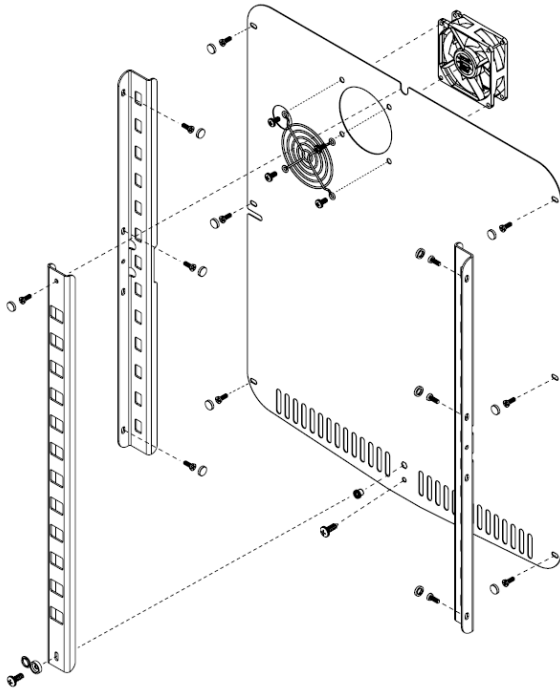

Beverage Center: Exploded view of interior and shelving

SEE Section 8.4 regarding the evaporator cover drip edge pertaining to all models

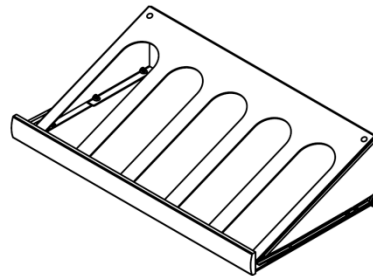
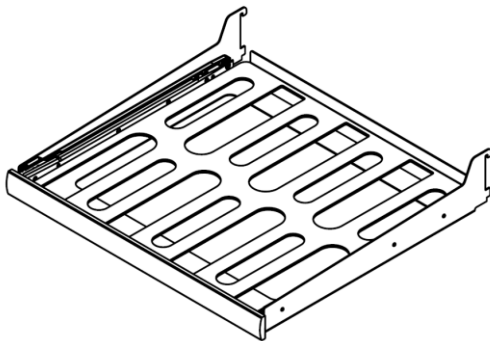

Beverage center only: The cabinet thermistor will have to be removed from its shield to allow it to pass through the removed cantilever bracket.

8.2: Wine Coolers:

Wine coolers have slide rail shelving with 7 pairs of slide rails on each side of the interior cabinet.

1. Remove all shelving.
2. Remove decorative plastic snap caps.
 - a. The plastic cap located at the top center of the coil cover is hinged on one side; it is slightly larger than the remaining plastic decorative snap caps.
3. Remove screws around the perimeter of the coil cover.
4. Carefully remove the coil cover and disconnect the evaporator fan and thermistor wires as needed.

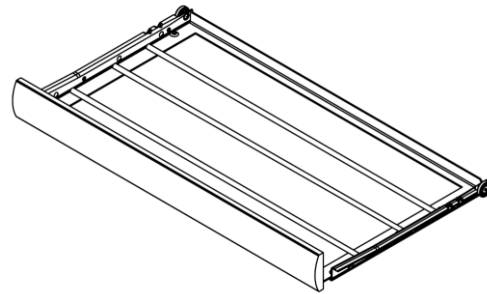

8.3: Refrigerated Drawers

NOTE: Refer to Section 19 for a Service Bulletin regarding a mullion heater kit.

To gain access of the evaporator and associated components located behind the coil cover.

1. Remove both top and bottom drawer (see section 7.4.1: Drawer Removal).
2. Disconnect the communication cable at the rear of the top drawer.
3. Remove the mullion bracket screws. (**see section 15: SERVICE KITS for additional information**).
 - a. Remove the two top sheet metal screws securing the right hand mullion bracket to the cabinet. Loosen the rear screw. The mullion bracket will stay with the mullion when it is removed.
 - b. Remove the sheet metal screws on the top and bottom of the left hand mullion bracket. The mullion bracket will stay attached to the cabinet.

4. The mullion trim strip has a small lip that rests under the cabinet flange. The fascia screw on each end of the mullion does not need to be removed.
5. To remove mullion:
 - a. Grasp the mullion with each hand.
 - b. Push mullion to the right to clear lip of flange on the left.
 - c. Rotate mullion forward to clear the mullion from brackets and liner.
 - d. Lift outward to remove.
6. Disconnect the LED harness on the right hand side of the mullion assembly.
7. Remove the decorative screw caps and screws that secure the coil cover.
8. Remove the P-clamp to the communication cable on the top right hand side of the coil cover. This will allow enough slack to pull the coil cover outward.
9. Remove the coil cover by pulling outward on the right hand side to clear the rocker switches on the left hand side of the cabinet.
10. Disconnect the fan harness; defrost thermistor, and cabinet thermistor as needed.



Remove top and bottom drawers.

Disconnect the communication before drawers are removed.

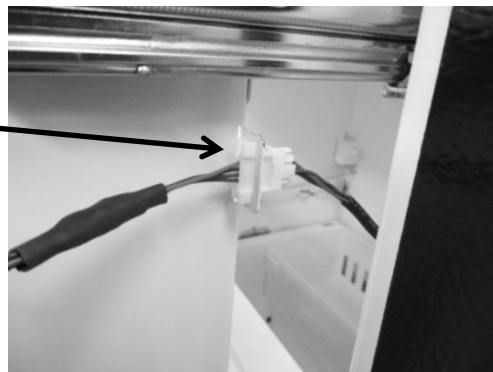



Remove two screws on the **top** of the mullion bracket, and one on the **bottom**.

Mullion fascia trim does not have to be removed.

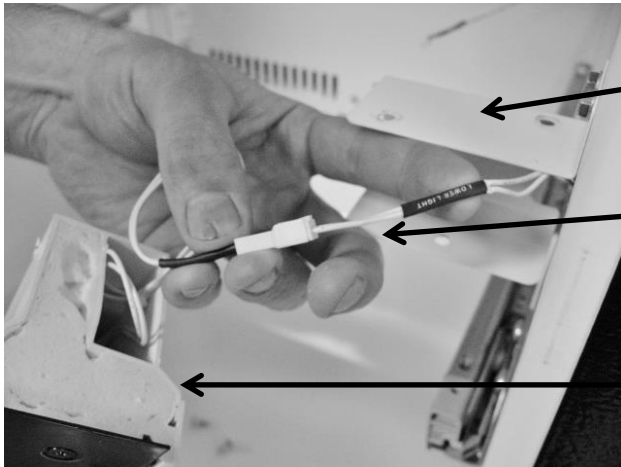

Bottom mullion bracket.

Wiring harness for the mullion LED. NOTE Disconnect.

Side View of Mullion Assembly.



Remove the decorative screw caps and screws.



Remove P-clamp



The coil cover can now be removed.

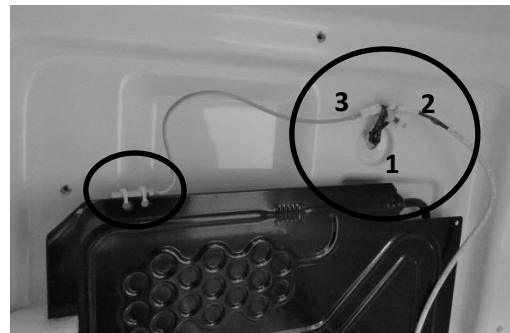

The defrost thermistor is shown in photo (left-red). Also shown are disconnects for the following: (1) fan cable (2) communication cable and (3) defrost thermistor.

8.4: Evaporator Cover Drip Edge

The bottom of the evaporator cover has two plastic drip edges to deflect water/condensation into the drain sump. These pieces need to remain on the cover for proper drainage.

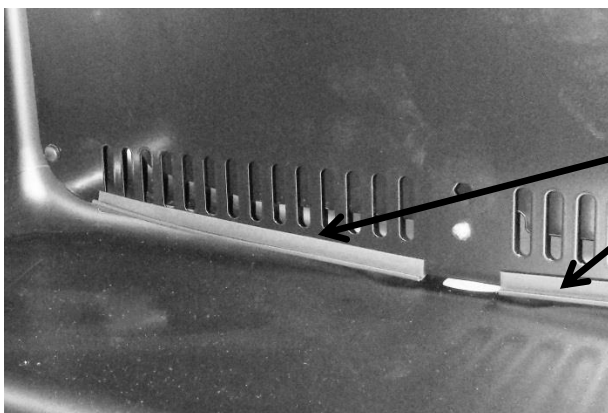

Drip edge on bottom of evaporator cover.

Section 9: Wiring Diagram

9.1 Block Diagram of Main Power Board

9.1.1 Single Zone

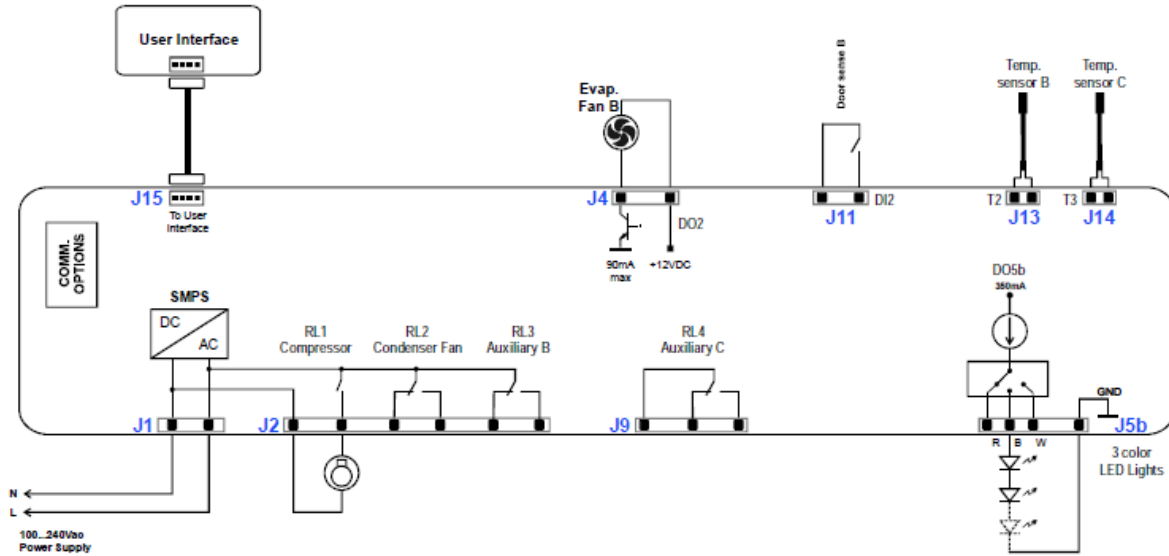

9.1.2 Dual Zone

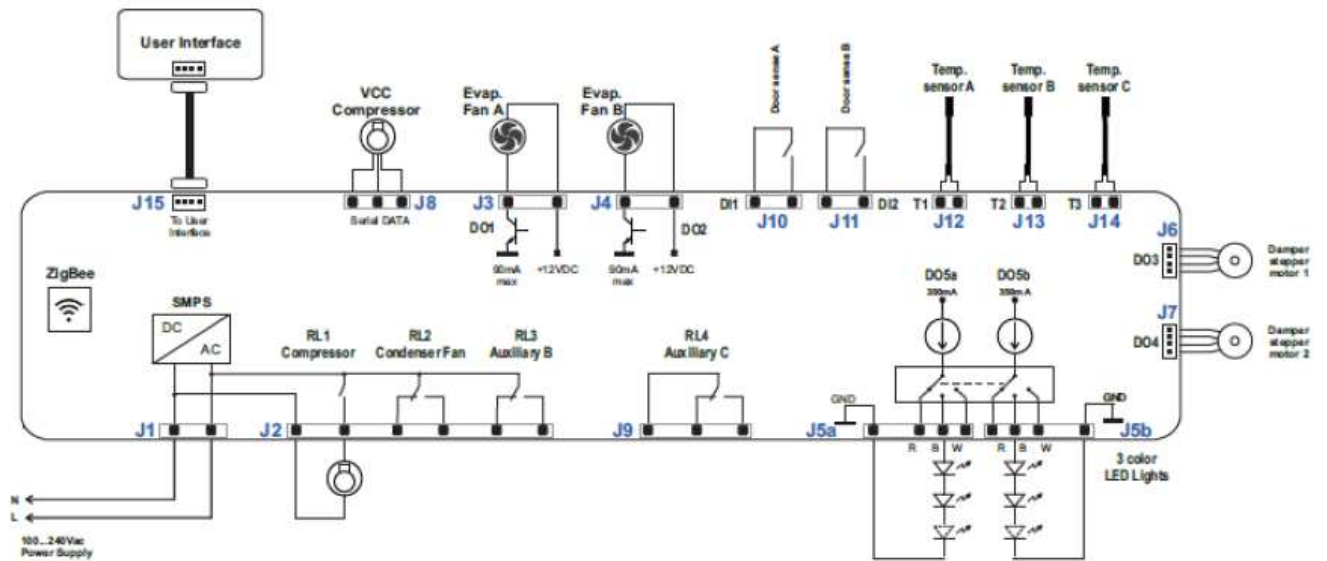

9.2 Schematic Diagram

9.2.1 Single Zone

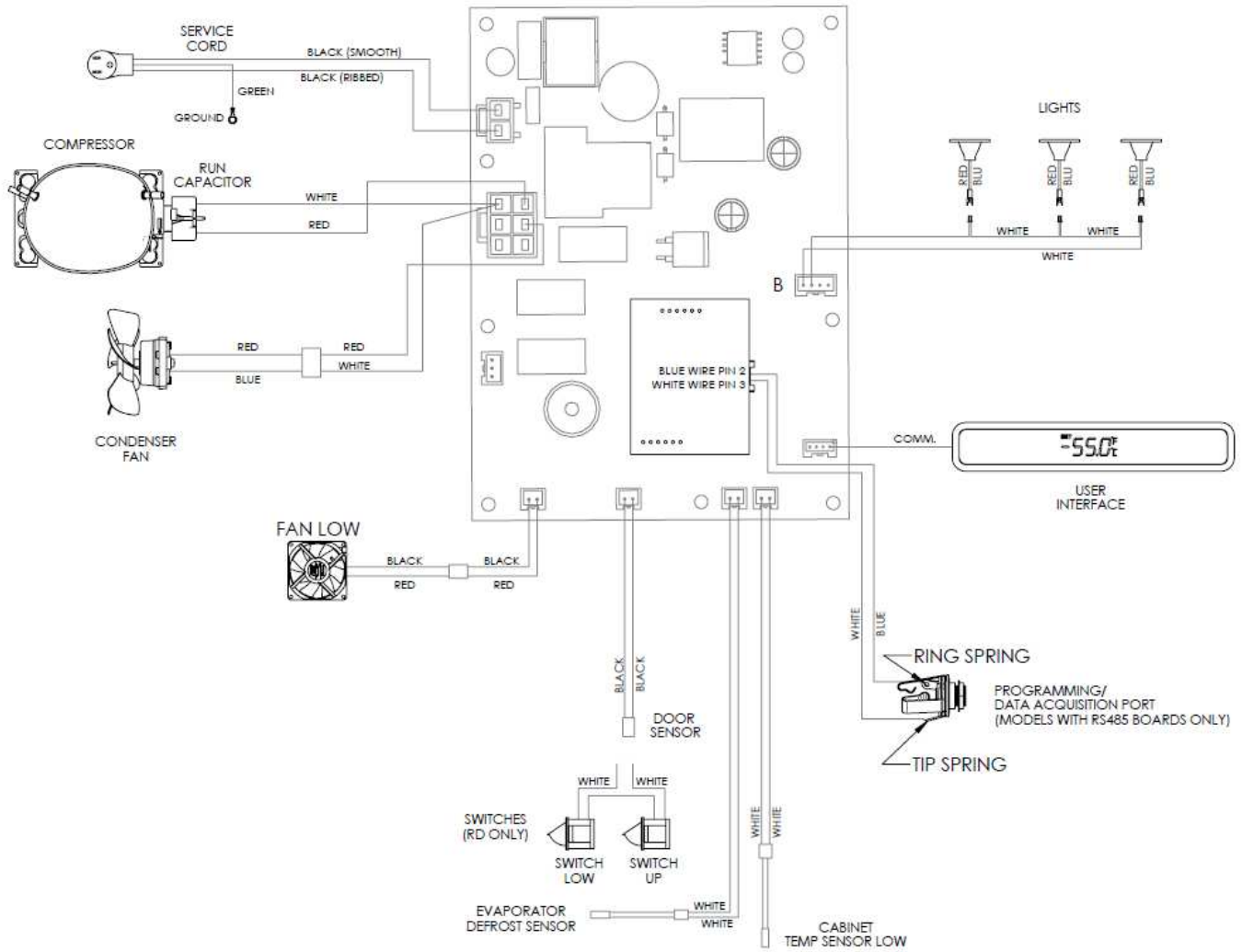

9.2.2 Single Zone – Beer Dispenser

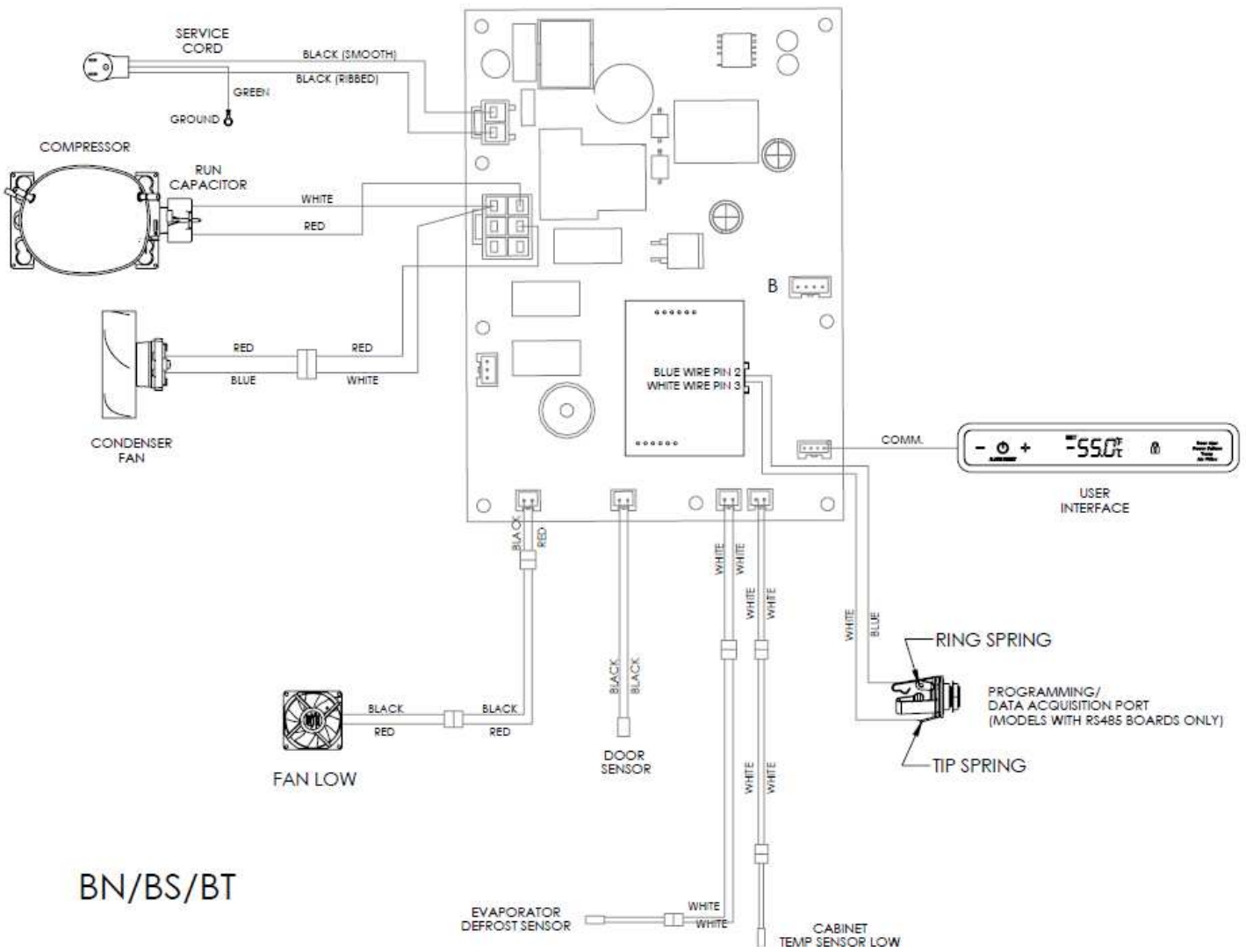

9.2.3 Dual Zone

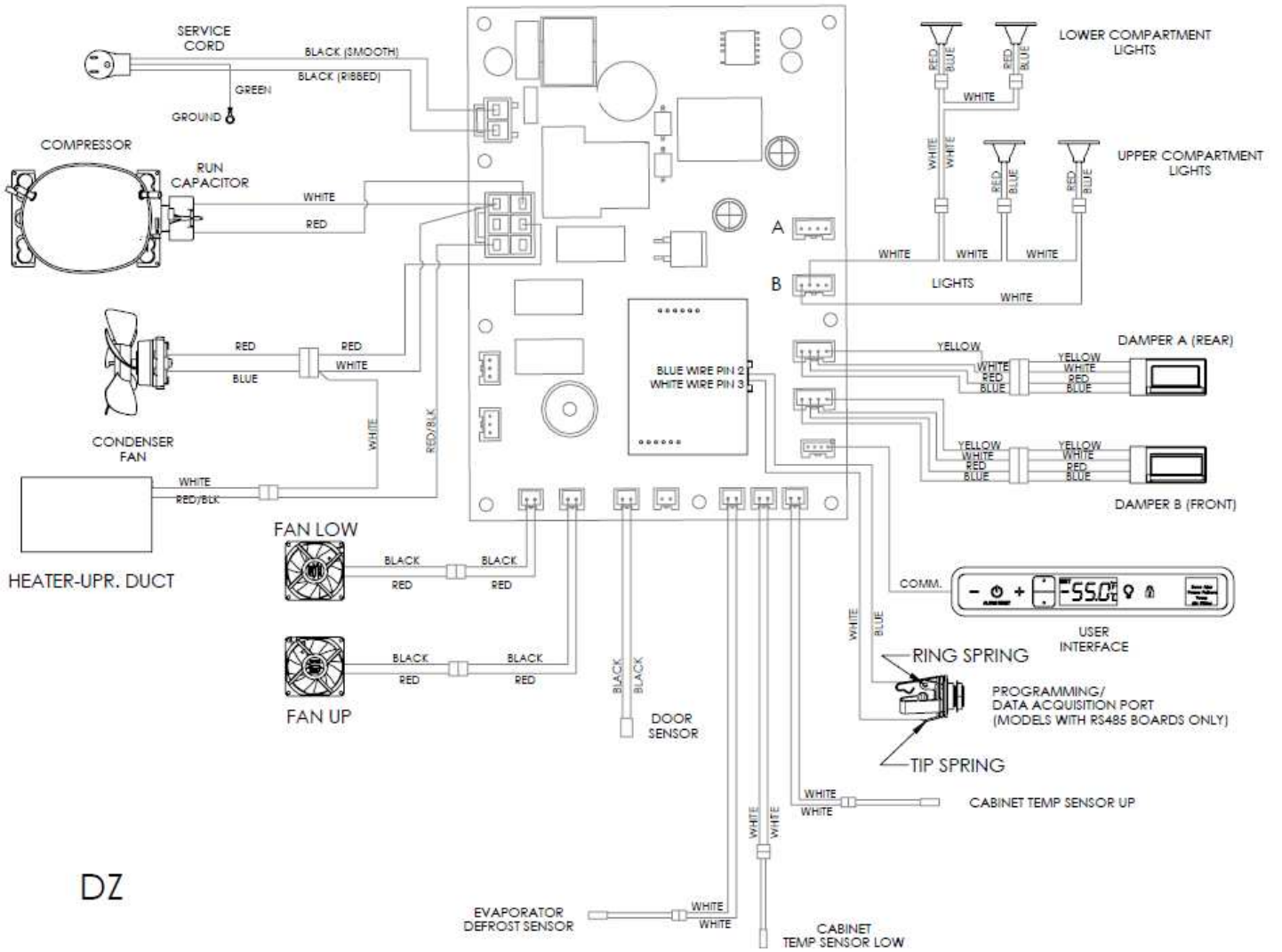

9.3 Main Power Board Identification

9.3.1 Single Zone

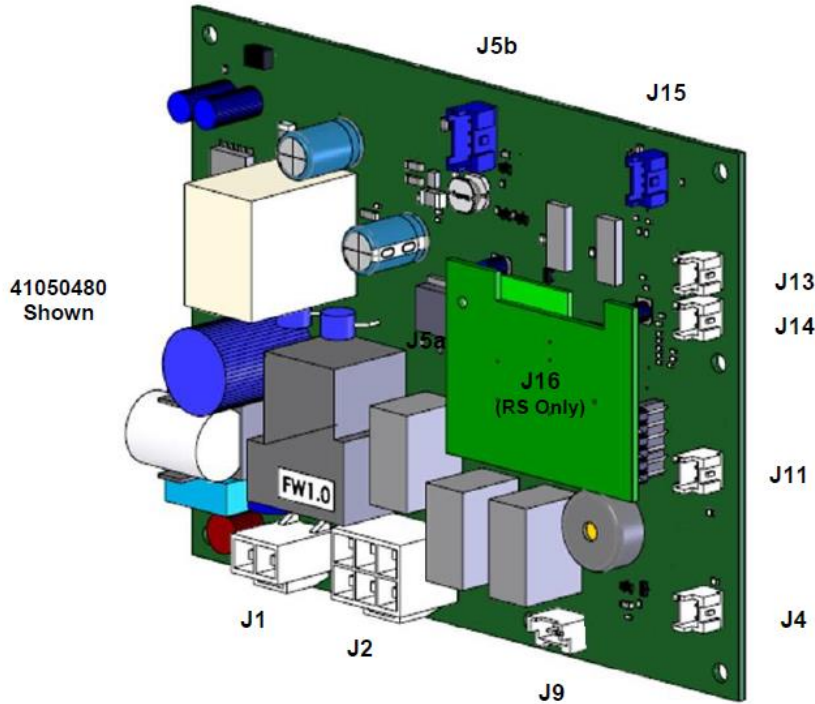

HEADERS, SINGLE ZONE

UI PCA

Ref Des	Manufacturer	PN	Circuit
J1	JST	SM04B-PASS-1-TBT	Communication to Main
J2	JST	09FMN-SMT-A-TF-LEFT	ICON/Key Switch

MAIN PCA

Ref Des	Manufacturer	PN	Circuit
J1	JST	B02P-VL	Power IN
J2	JST	B08P-VL	Comp / Cond / AUX B
J4	JST	B02B-XASK-1	Evaporator Fan B
J5b	JST	B04B-XASK-1	Lights
J9	JST	B03B-XASK-1	AUX C
J11	JST	B02B-XASK-1	Door Sensor B
J13	JST	B02B-XASK-1	Temp Lower
J14	JST	B02B-XASK-1	Temp Defrost
J15	JST	SM04B-PASS-1-TBT	Communication to UI

RS PCA

Ref Des	Manufacturer	PN	Circuit
J16	JST	SM04B-PASS-1-TBT	Programming / Data Logger

9.3.2 Dual Zone

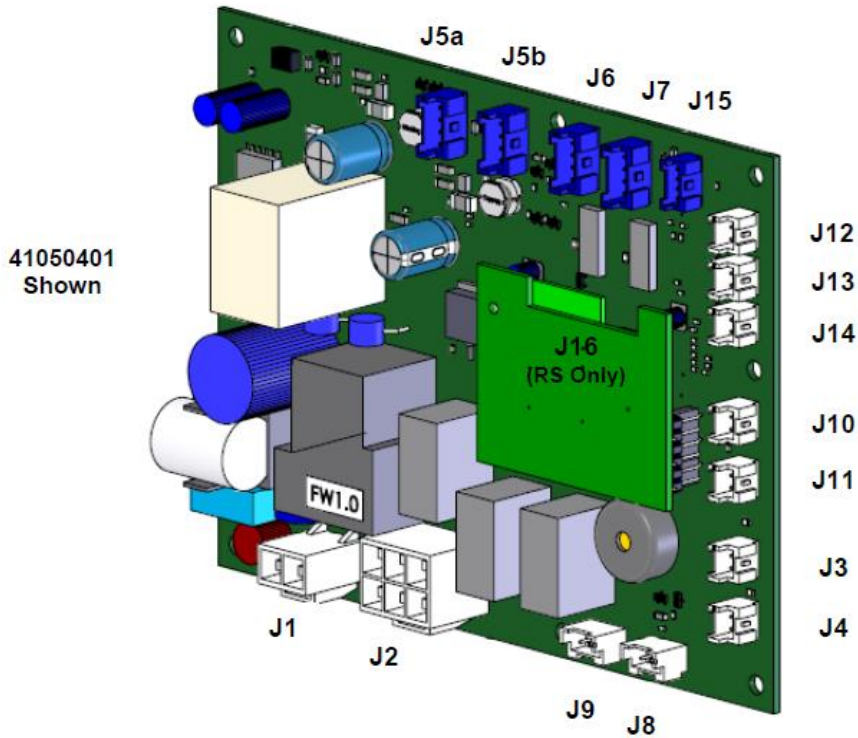

HEADERS, DUAL ZONE

UI PCA

Ref Des	Manufacturer	PN	Circuit
J1	JST	SM04B-PASS-1-TBT	Communication to Main
J2	JST	09FMN-SMT-A-TF-LEFT	ICON/Key Switch

MAIN PCA

Ref Des	Manufacturer	PN	Circuit
J1	JST	B02P-VL	Power IN
J2	JST	B08P-VL	Comp / Cond / AUX B
J3	JST	B02B-XASK-1	Evaporator Fan A
J4	JST	B02B-XASK-1	Evaporator Fan B
J5a	JST	B04B-XASK-1	Lights
J5b	JST	B04B-XASK-1	Lights
J6	JST	B04B-XASK-1	Damper 1
J7	JST	B04B-XASK-1	Damper 2
J8	JST	B03B-XASK-1	VCC Compressor
J9	JST	B03B-XASK-1	AUX C
J10	JST	B02B-XASK-1	Door Sensor A
J11	JST	B02B-XASK-1	Door Sensor B
J12	JST	B02B-XASK-1	Temp Upper
J13	JST	B02B-XASK-1	Temp Lower
J14	JST	B02B-XASK-1	Temp Defrost
J15	JST	SM04B-PASS-1-TBT	Communication to UI

RS PCA

Ref Des	Manufacturer	PN	Circuit
J16	JST	SM04B-PASS-1-TBT	Programming/Data Logger

SECTION 10: Power on Reset Mode

10.1: Auto Self-Test

Every “power on reset” (POR) will initiate an “auto self-test”. After each loss of power the control will do a self-check once power is restored. This sequence will not be noticeable to the owner.

During the auto self-test mode, the following conditions are evident:

- Current temperature is displayed.
- Lights work normally.
- User can adjust the temperature set-points.
- Lock function works normally.
- ON/OFF key works normally.
 - NOTE: If the unit is turned “OFF” during the auto-self test, the unit will not be disabled until the conclusion of the test.
- Green LED status indicator works normally.

In addition, during the auto self-test mode, the software version can be displayed by pressing and holding the ON/OFF key while simultaneously pressing the LOCK key. During the auto self-test the loads are sequentially enabled and then disabled.

10.2: Manual Auto Test Mode

An “auto test” can automatically be activated by the following key dance: Press and hold the LOCK and + (plus) keys simultaneously. During the manual test mode, the software version is automatically displayed until the test is complete.

Example: Display while in manual test mode: **4** (shows software version)

NOTE: The auto test sequence is identical in both POR and manual modes.

10.3: Control Types

- Single zone
- Dual zone

10.3.1 SINGLE ZONE:

AUTO TEST MODE	
LOAD	ENABLED
Condenser (AUX A)	On for 15 seconds then OFF. Pause 2 seconds
Evaporator	On for 15 seconds then OFF. Pause 2 seconds
AUX C	On for 15 seconds then OFF. Pause 2 seconds
Comp & Cond Fan ONLY	On for 5 minutes then exit AUTO-TEST and RETURN to NORMAL OPERATION. NOTE: If there is a "Call for Cooling", upon return to normal operation, the compressor and condenser fan will remain enabled.

10.3.2 DUAL ZONE:

AUTO TEST MODE	
LOAD	ENABLED
Condenser (AUX A)	On for 15 seconds then OFF. Pause 2 seconds
Evaporator Fan A	On for 15 seconds then OFF. Pause 2 seconds
Evaporator Fan B	On for 15 seconds then OFF. Pause 2 seconds
Damper A	Completes one CLOSE/OPEN/CLOSE cycle then OFF. Pause 2 seconds
Damper B	Completes one CLOSE/OPEN/CLOSE cycle then OFF. Pause 2 seconds
AUX B	On for 15 seconds then OFF. Pause 2 seconds
AUX C	On for 15 seconds then OFF. Pause 2 seconds
Comp & Cond Fan ONLY	On for 5 minutes then exit AUTO-TEST and RETURN to NORMAL OPERATION. NOTE: If there is a "Call for Cooling", upon return to normal operation, the compressor and condenser fan will remain enabled.
NOTE	No two loads can be on at the same time. The previous load must be completely "Off" before the next load is enabled.

SECTION 11: Quick Reference Troubleshooting Guide

COMPLAINT	CONDITION	CAUSE
<u>ERROR CODES</u>		
EL	Compartment Thermistor: Open or shorted (no audible tone).	Broken / Worn / Shorted thermistor: Check resistance (Ohm) and replace.
Ed	Defrost Thermistor: Open or shorted (no audible tone).	Broken / Worn / Shorted thermistor: Check resistance (Ohm) and replace.
EL / Ed	Multiple Thermistor Failures: Open or shorted (no audible tone).	Broken / Worn / Shorted thermistor: Check resistance (Ohm) and replace.
<u>ALARMS</u>		
Door Ajar	“Door Ajar” will flash on Display (with audible tone.)	Appliance door has been open or ajar for a period of 5 + minutes. Close door or press ON/OFF key to reset.
Power Failure	“Power Failure” will flash on Display (no audible tone).	Internal / External related supply power disturbance. Press ON/OFF key to reset.
Temperature	Compartment is 10 + degrees higher / lower than Set Point for longer than 1 hour.	Electrical / Mechanical / Installation related. Alarm will sound every 60 seconds>Press ON/OFF key to reset. Alarm will continue until cause is corrected.
<u>MISC</u>		
Unit does not operate.	Lack of power to the unit or display.	Check power to the appliance and power at the main power board.
Display Blank	Lack of power/ Display off/ Faulty display.	Attempt to turn on display/ Check for incoming power to appliance and display.
Compartment temperature to cold.	Faulty thermistor/ Compartment Fan Failure / System failure.	Check resistance (Ohm) and replace compartment thermistor.
Compartment temperature to warm.	Product not Stabilized/ Faulty Thermistor/ Electrical or Mechanical failure.	Stabilize 24 hours/ Check resistance (Ohm) and replace thermistor/ Check fan / Look for leak or restriction.
Compressor does not run.	No Power to compressor/ Faulty compressor or overload -relay/ Faulty main power board.	Bad main power board/Check compressor windings/Check overload and relay.
Compressor runs but doesn't cool.	Mechanical failure	System Leak
Compressor hot/ tripping.	Faulty compressor windings, overload, relay.	Shorted or grounded compressor windings, overload, and relay.
Excessive frost/ice build- up on evaporator.	Excessive door/drawer openings or Mechanical failure.	Customer education/ Restriction/ Overcharge.
Uneven frost pattern on evaporator.	Mechanical failure	System leak/ Restriction
Condensate on face of gaskets/mullion/doors.	High Humidity	Check repair / replace gaskets, Adjust doors/drawers.

Section 12: Flow Chart Diagnostics

12.1: Does Not Run

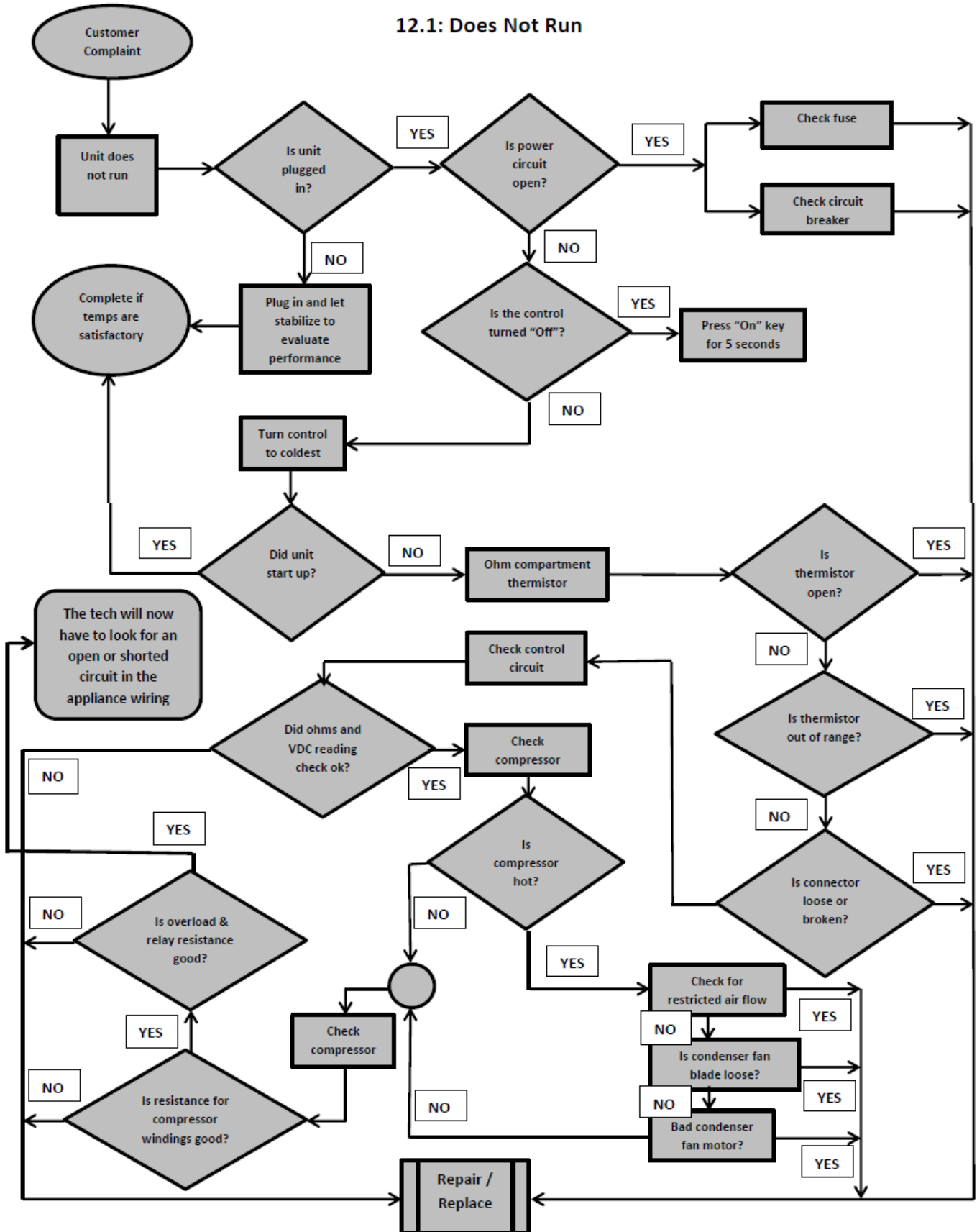

12.2: Too Cold

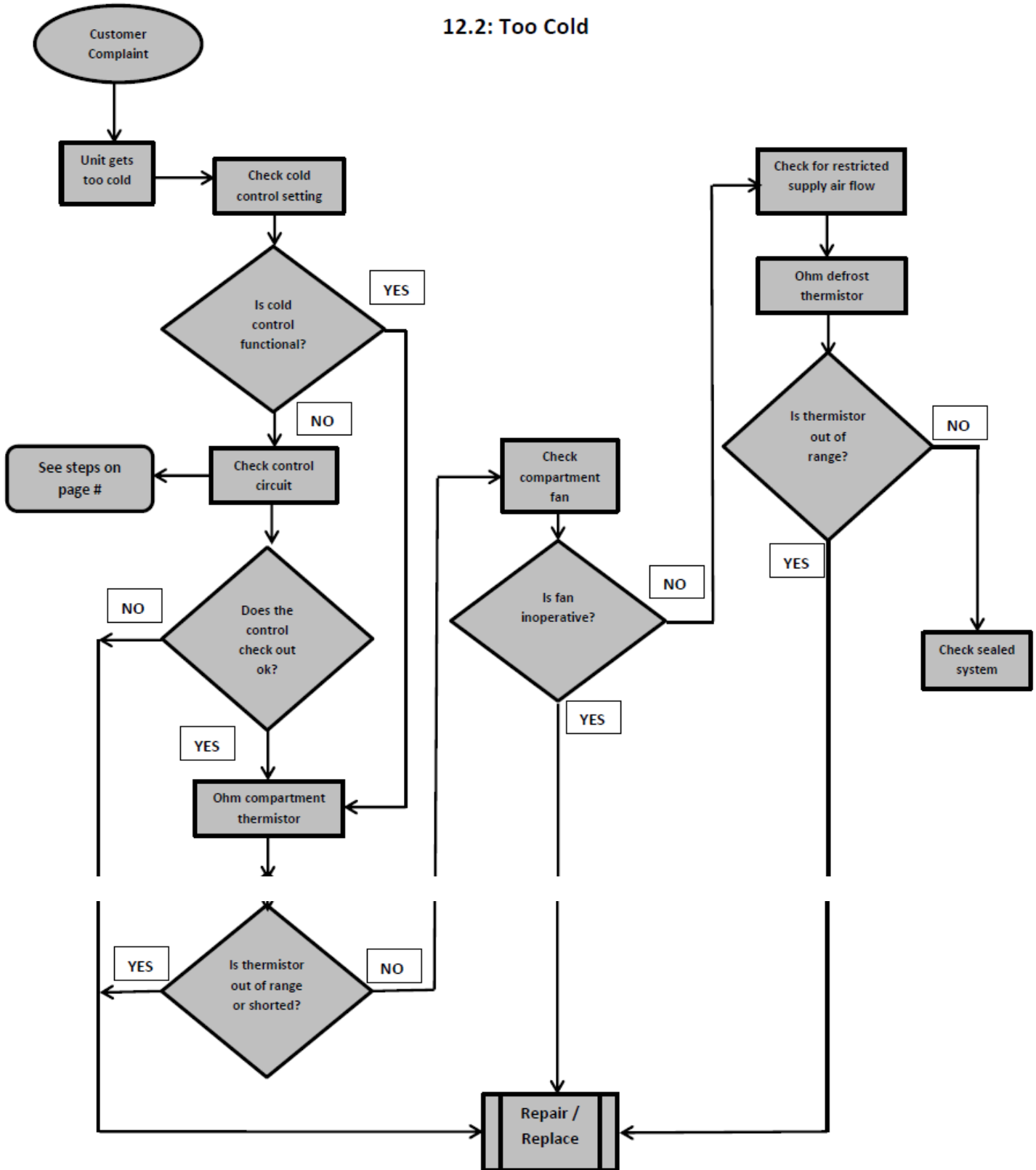

12.3: Not Cooling

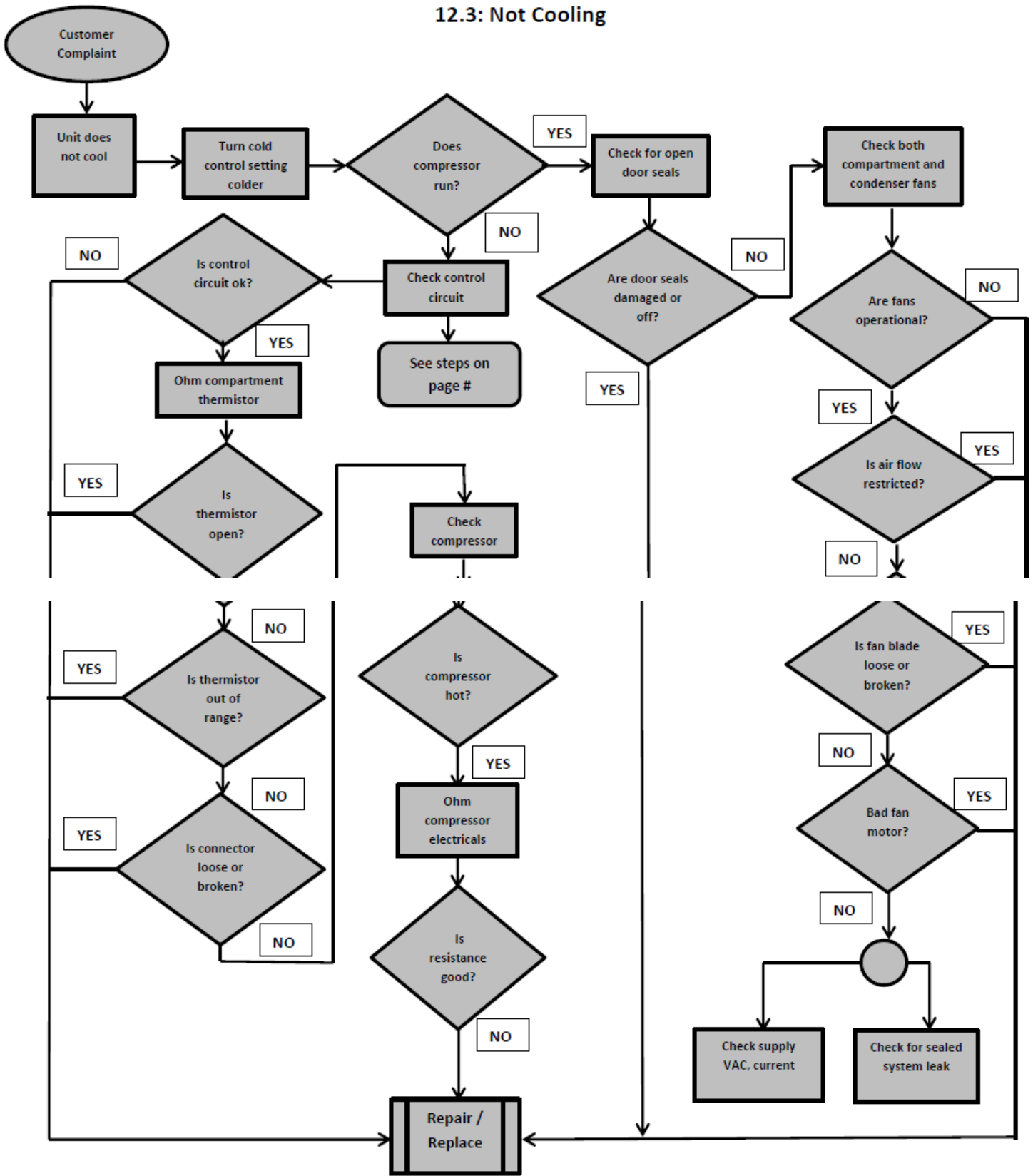

12.4: Runs Continuously

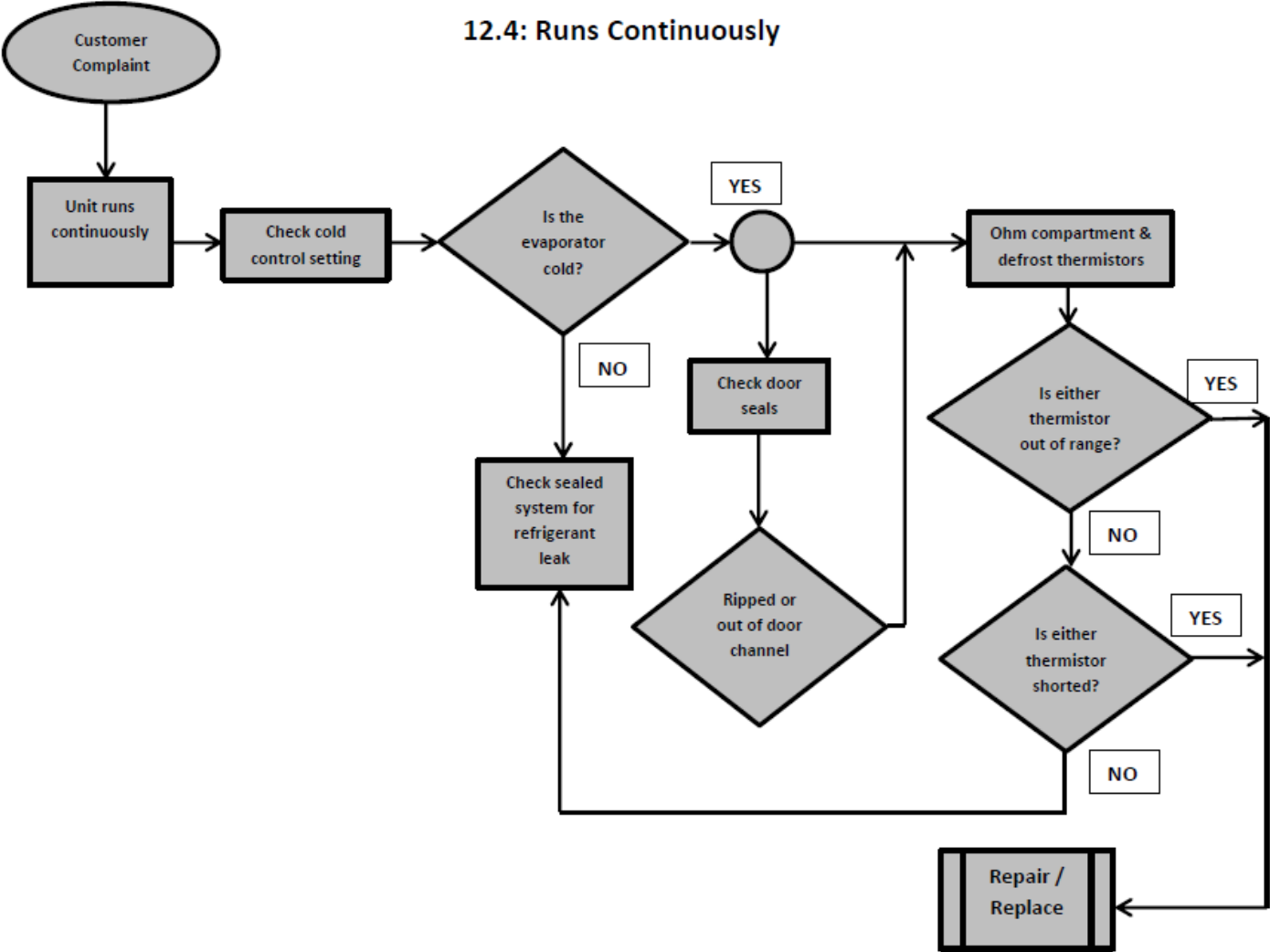

12.5: Excessive Noise

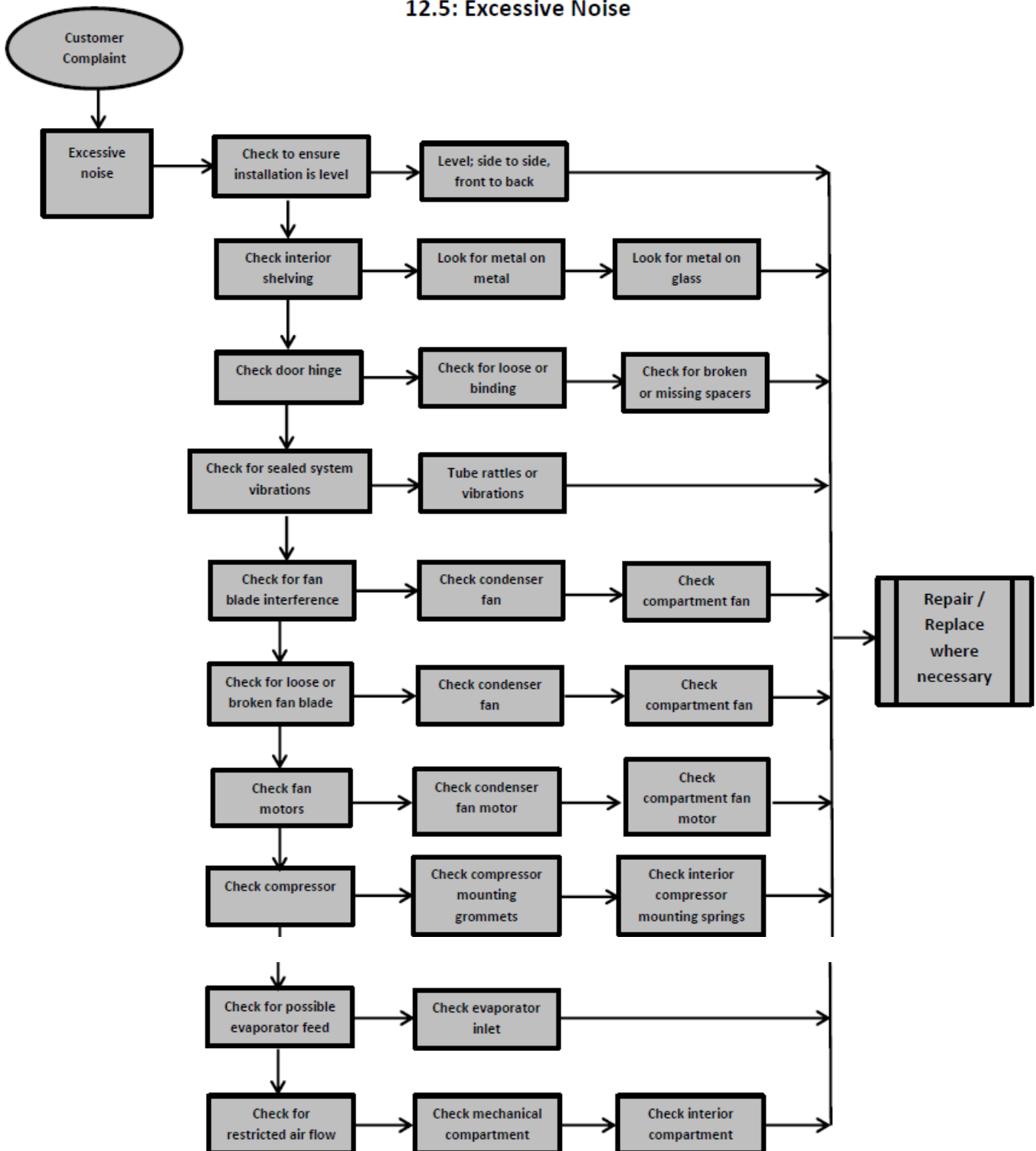

LED Interior Lighting Trouble Chart

Under-Counter Aurora Control System

1 to 4 Light Pod Systems

PAGE 1

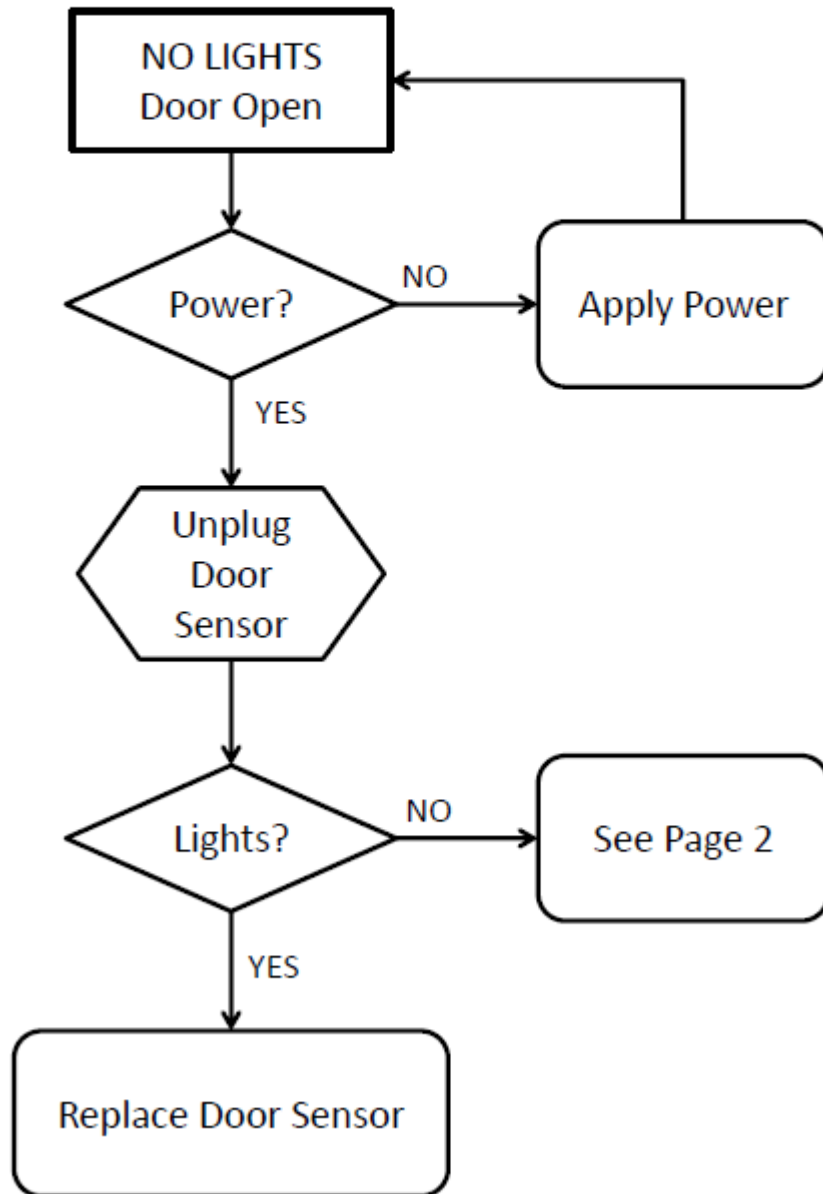

LED Interior Lighting Trouble Chart

Under-Counter Aurora Control System

1 to 4 Light Pod Systems

PAGE 2

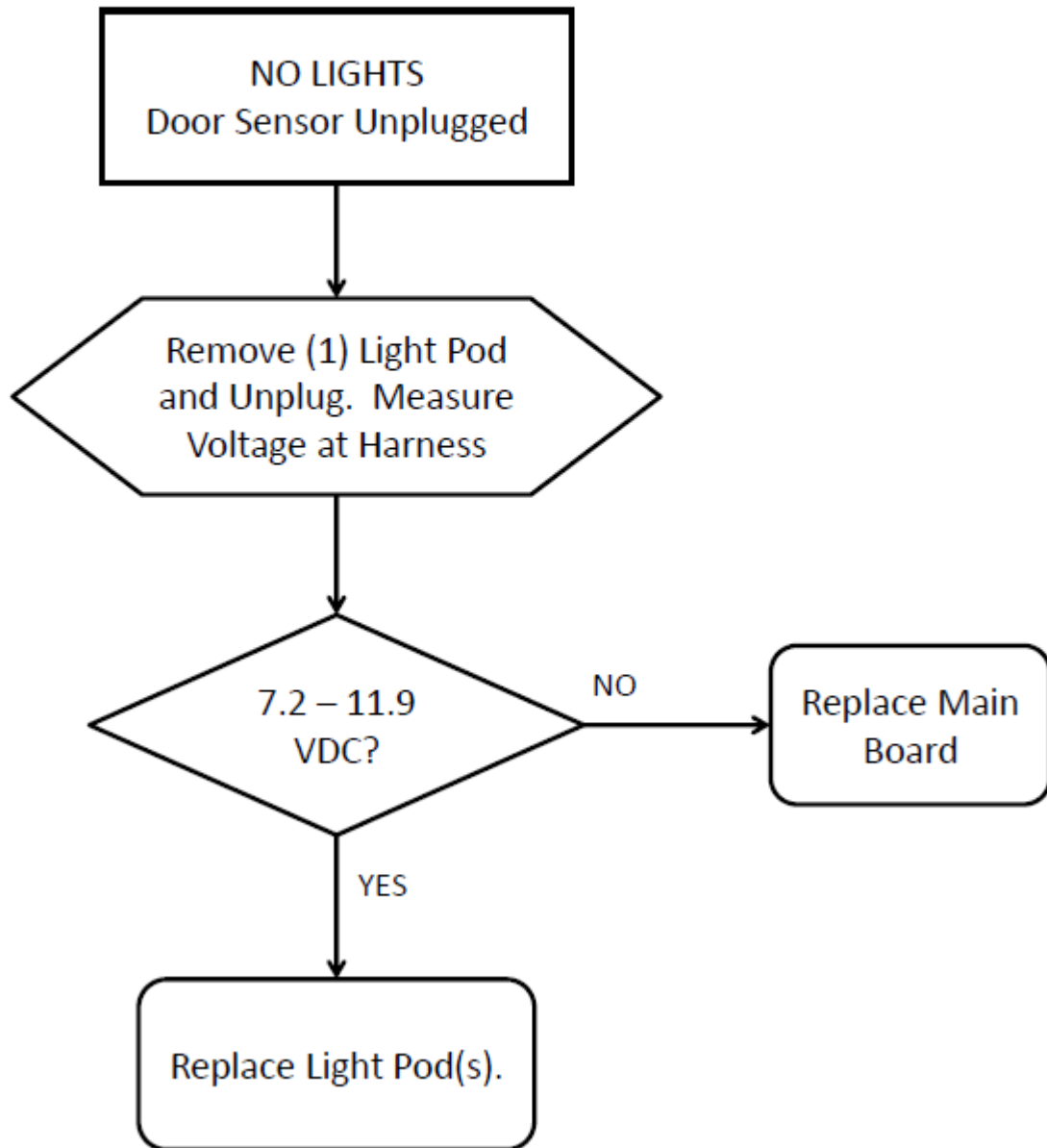

Section 13: Service Data

13.1: PROGRAM PORT



Programming or re-programming is accomplished through a port located behind the toe grill. Model specific, factory default settings cannot be modified or adjusted in the field. However, if a new software or firmware version becomes available it is possible to upload the latest version through this program port.

13.1.1: SERVICE DATA RETRIEVAL

Historical data can be downloaded in a file format compatible with Microsoft® Excel through a PC USB port. Historical data will record a running report of the past 72 hours.

The service data report will be formatted in a time sequence as follows:

EXAMPLE:

0	=	Current Time
-1	=	1 Hour Ago
-2	=	2 Hours Ago
-3	=	3 Hours Ago
		
-72	=	72 Hours Ago

Data available per report is

- Cabinet temperature set point
- Temperature sensor A (average)
- Temperature sensor B (average)
- Temperature sensor C (average)
- Number of door A Detections
- Number of door B Detections
- Number of compressor “ON” Cycles
- Number of defrosts
- Number of alarms

The data cable and application will be available upon request from AGA Marvel customer service (1-800-223-3900).

The retrieved data format will apply to a standard excel spreadsheet.

PROGRAM PORT

Model programming is accomplished through a port connection located behind the front grill of the unit.

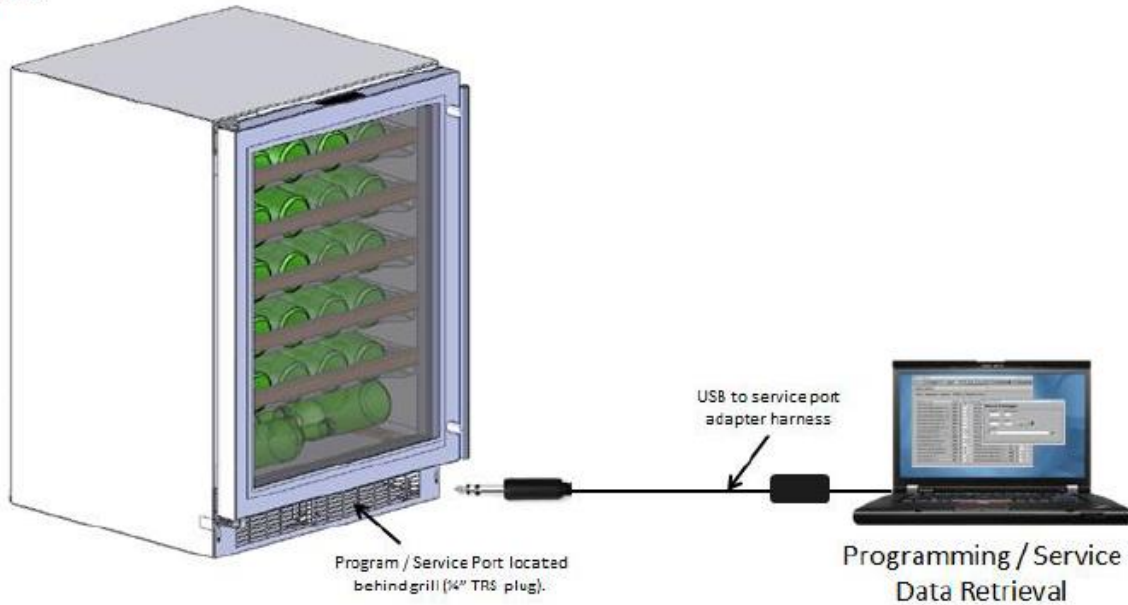

13.1.2: Service Data Port Location

The service data cord will connect to the technician's computer with a USB connection on one end and then into the appliance data port by means of a jack plug.

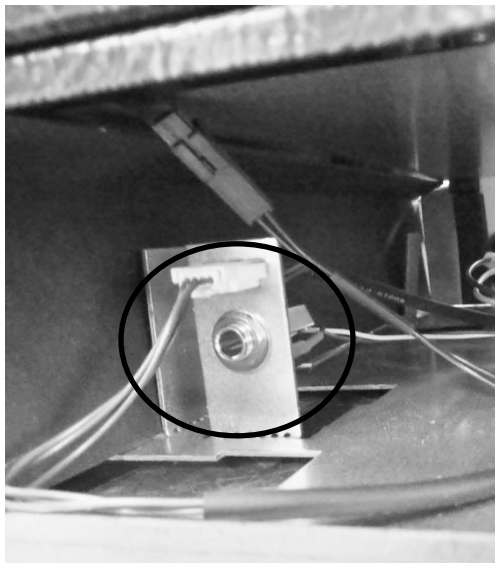

13.1.3: Onboard Diagnostics

POR Auto Test Mode

Every POR will initiate AUTO SELF TEST. The User Interface will simulate normal operating conditions during POR SELF TEST. In other words should there be a power loss the user must be unaware of AUTO TEST MODE when the power returns. During auto test:

1. Current temperature is displayed.
2. Lights work normally.
3. User can change the temperature set-points.
4. Lock function works normally.
5. ON/OFF key works normally.

NOTE: If the unit is turned OFF during POR SELF TEST, the unit is not actually disabled until the SELF TEST is complete.

6. Green LED status indicator works normally.

During the Auto-Test, the programmed software version (Aurora Settings Program Application) can be displayed by pressing and holding the ON/OFF key while pressing the LOCK key. During POR AUTO SELF TEST the loads are sequentially enabled then disabled. See Auto Test Mode table below. Initial factory programming sets POR Auto Test Mode to YES.

Manual Auto Test Mode

Auto Test can be activated manually by pressing and holding the LOCK and PLUS (+) keys. During manual test mode the software version is displayed until Auto Test is complete. NOTE: Auto Test sequence is identical in POR or Manual execution.

AUTO TEST MODE	
LOAD	ENABLED
Condenser (Aux A)	ON for 15 sec then OFF. Pause 2 sec.
Evaporator Fan A	ON for 15 sec then OFF. Pause 2 sec.
Evaporator Fan B	ON for 15 sec then OFF. Pause 2 sec.
Damper A	Completes one CLOSE / OPEN / CLOSE cycle then OFF. Pause 2 sec.
Damper B	Completes one CLOSE / OPEN / CLOSE cycle then OFF. Pause 2 sec.
Aux B	ON for 15 sec then OFF. Pause 2 sec.
Aux C	ON for 15 sec then OFF. Pause 2 sec.
Compressor & Condenser Fan ONLY	ON for 5 minutes then EXIT AUTO-TEST and RETURN TO NORMAL OPERATION. <i>NOTE: If there is a CFC upon returning to normal operation, the compressor & condenser fan will remain enabled.</i>
NOTE:	<i>No two loads are on at the same time. The previous is completely off before the next load is enabled.</i>

Sensor Error Detection

The temperature sensors are monitored continuously. Any OPEN or SHORTED circuit condition will initiate an ERROR CODE. Code will flash continuously at 1 sec intervals. Multiple sensor failures will share intervals. No audible alarm will sound. See table below.

SENSOR ERROR CODES	
SENSOR	CODE
Sensor A (Upper)	EU
Sensor B (Lower)	EL
Sensor C (Defrost)	Ed

Section 14: Beer Dispenser



Caution

Prior to proceeding with any of the following steps the main power to the appliance and/or the power cord should be disconnected from the power supply. Failure to do so could result in severe shock.

14.1: Interior mechanical / electrical components

The components are accessible as described in previous sections.

- Remove all interior beer dispenser accessories: keg, co2 tank, regulators, and lines.
- Remove shelving in lieu of keg equipment (depending on customers' installation).
- Remove plastic screw caps from freezer cover.
- Remove Phillips screws.
- Pull freezer cover away from back wall enough to disconnect the evaporator fan harness.
- The interior fan, both thermistors, and the evaporator plate is now exposed.
- **NOTE:** The evaporator fan for the beer dispenser has reversed air flow compared to the other Marvel models. The fan application is draw through. Interior cabinet air is pulled through the fan orifice, across the evaporator plate, and outwards from the louvers on the evaporator cover.



Note the two hole locations on the photo to the left.

The hole on the left hand side is used for ***factory test purposes only***; this is sealed with a white plastic cover.

The hole on the right hand side is used as a port to accommodate an optional field install kit for an externally mounted CO2 tank. This will also be sealed with a white plastic cover.

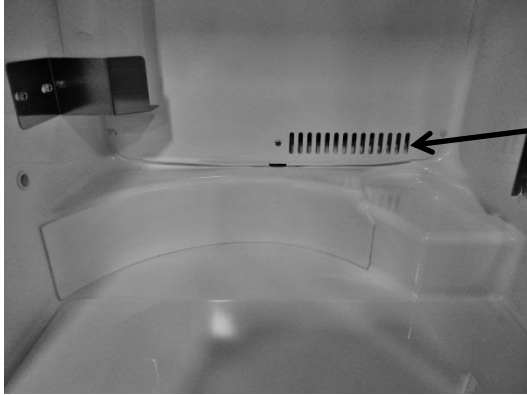

Supply air louvers on the evaporator cover.

Evaporator and thermistor location behind evaporator cover.

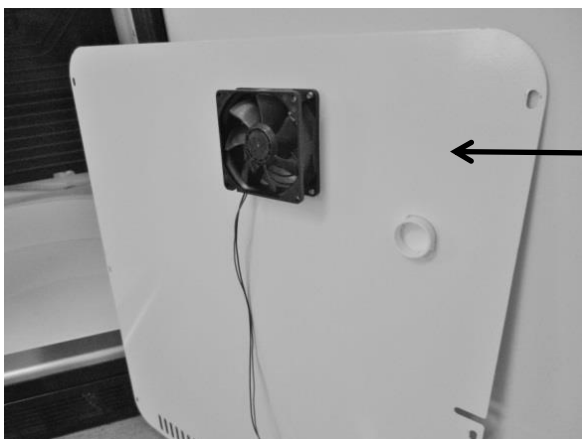
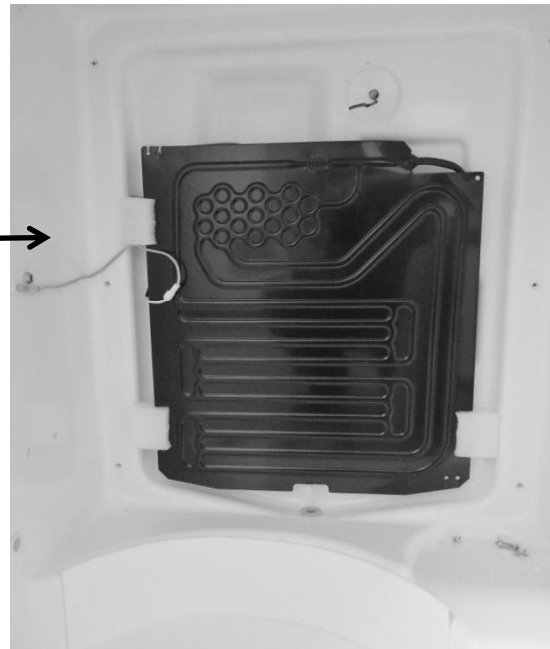

Evaporator fan is secured to the rear of the evaporator cover.

NOTE: Newer models made after 20150824xxxH also have a rear fan guard.

NOTE: As of mid-August 2015, a rear fan guard was added to the fan assemblies on beverage dispenser models. The fan guard is to eliminate the possibility of wires getting caught in the fan blade from behind the coil cover.

The approximate serial number range is 20150824xxxH. This is an approximate date and some variation may be seen in the field.

The following exploded view shows the assembly drawing of the coil cover components along with both the front and rear fan guards.

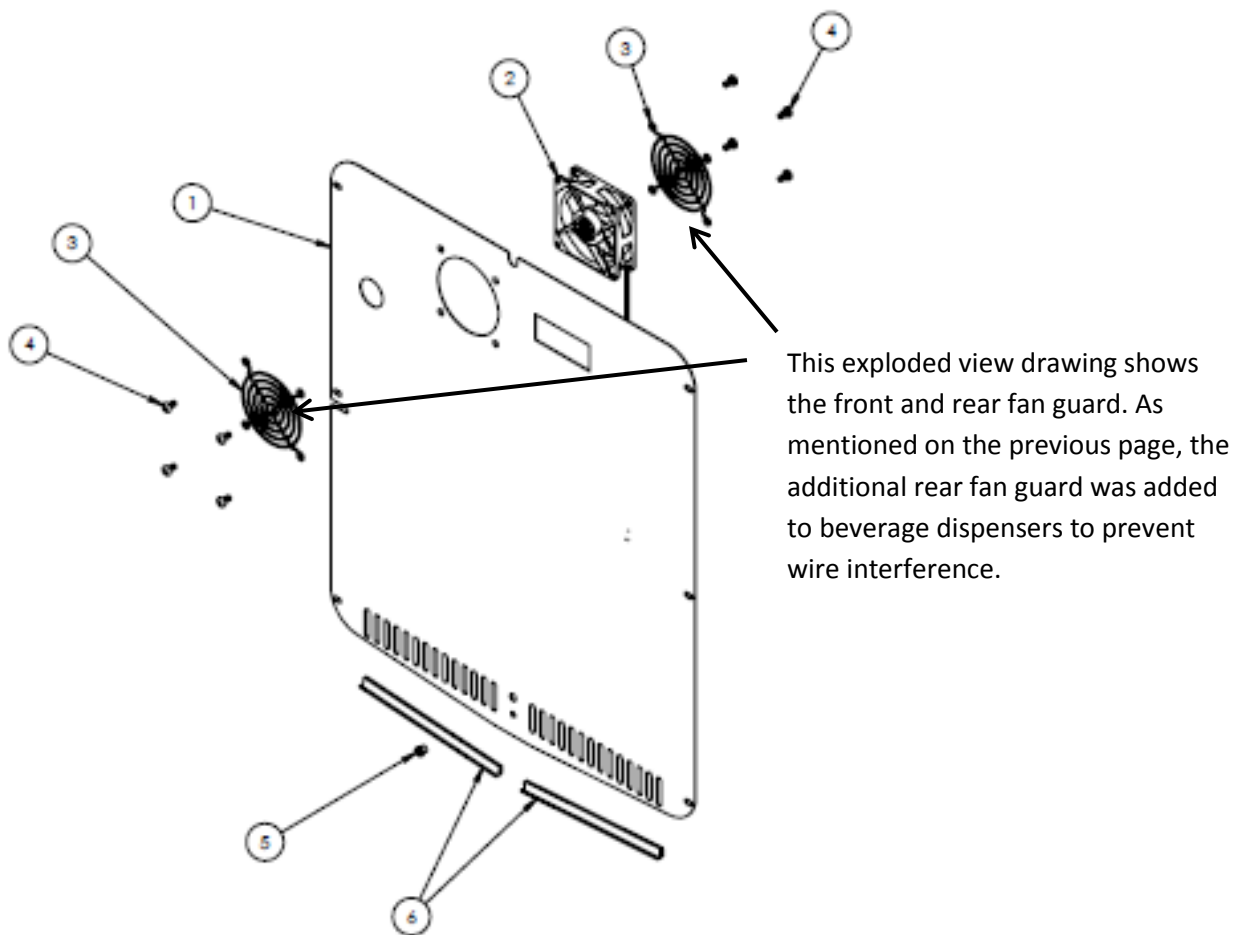

Air Flow on Beer Dispensers: The evaporator fan is a draw through design. Specification label will face towards the evaporator when installed correctly. The fan blades will rotate in a counter-clockwise direction as you face the hub.

Remove the four screws from the front of the coil cover to remove either fan.

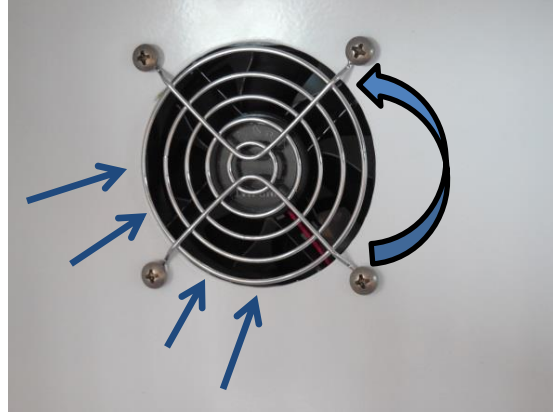

14.2: Main Control Board Access



Caution

Disconnect the main power supply to the appliance. Failure to do so could result in severe shock.

1. The main power board can be accessed as follows:
 - Remove the front toe grill.
 - Locate the control housing assembly. See below.
 - Use a Phillips screwdriver and remove the two screws securing the control housing assembly to the machine compartment base.
 - The control housing can now be slid outward away from the machine compartment.
 - **NOTE:** the rear of the control housing assembly is slotted to lock into a mounting tab on the cabinet base. When re-installing; care must be taken to ensure that the board is locked into place without pinching any wire harness.
 - Secure the control housing using the Phillips screws previously removed.
 - Replace the toe grill and secure.
2. The user interface functions the same as the other Aurora control systems.
 - See Sections 6 and 9 for reference.
3. Operating functions and navigation for the user interface can be reviewed in section 5.



To access the main power board; remove the toe grill.



Control housing assembly: The main power board is located in the front, right hand side, behind grill (beer dispensers only).

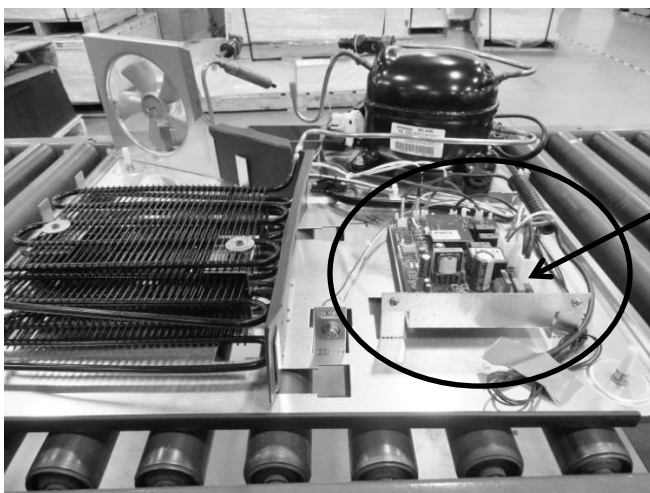

FOR REFERENCE: The bottom base assembly is shown to help identify component locations. The control housing assembly is circled in red.

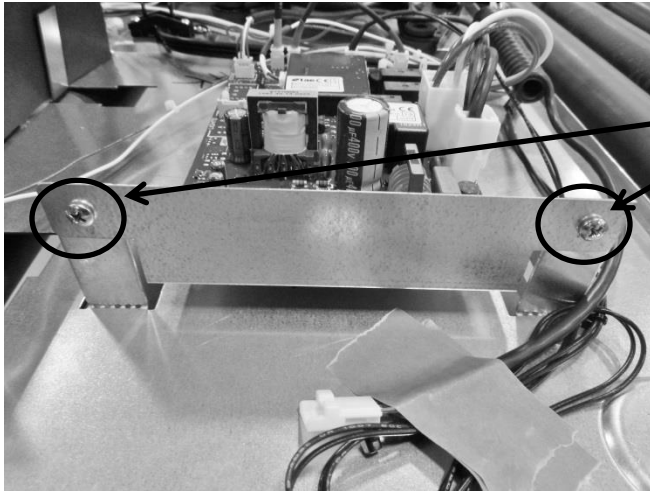

Note the two Phillips screws securing the front of control housing assembly.

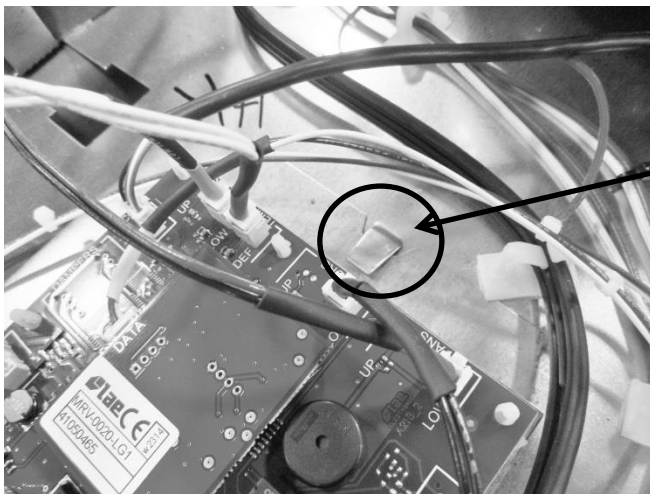

Note the slot and tab positioning.

14.3: Machine Compartment

Access to the machine compartment is standard on all Marvel models.

- The layout of the mechanical compartment is reconfigured due to the space constraints of maintaining the volume of the refrigerated space.
- See the Note below regarding the condenser fan.

14.3.1 Refrigeration and Mechanical

The basic refrigeration and mechanical operation and assembly are not unlike that discussed earlier in this manual. This information can be reviewed in chapters 3 and 4.

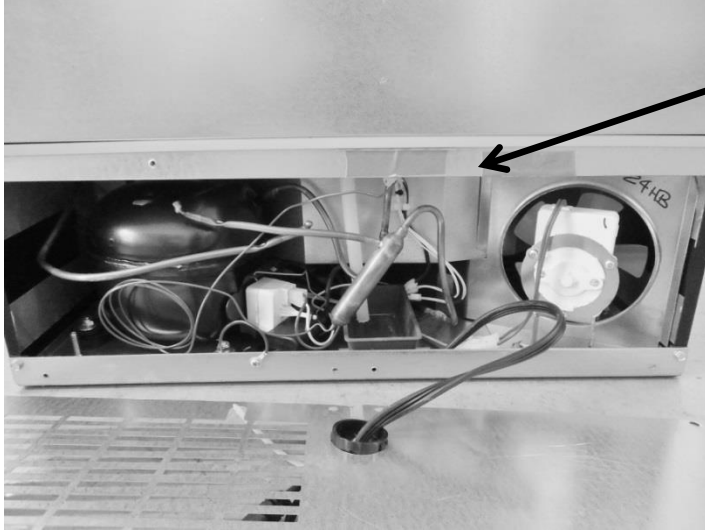

View of the machine compartment components with back panel removed. NOTE the location of the compressor, drain, condenser fan, and filter drier.

NOTE: The condenser fan blade used for the beer dispenser is 3/4" smaller in diameter than the blade used on the remaining Aurora control models.

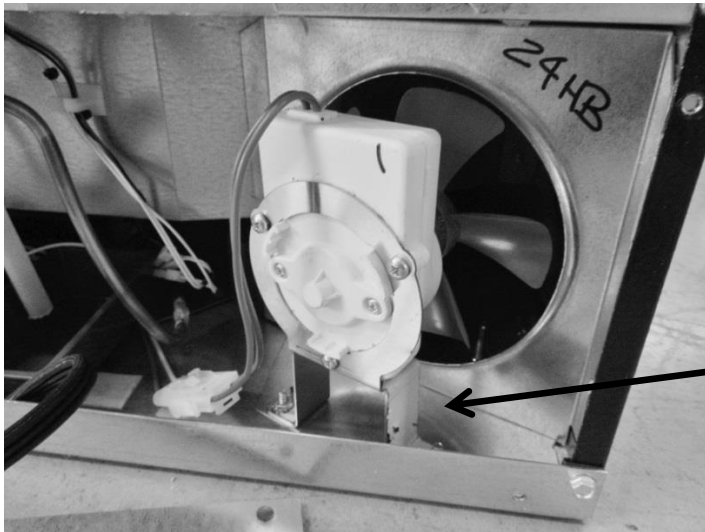

The condenser motor can be replaced by releasing the disconnect plug and removing the nuts holding the mounting bracket to the base assembly.

14.4: Excerpt from Owners / Maintenance Instruction Guide 41013400-Rev D

Shelving

The unit is shipped with the (2) shelves taped in place in the upper and the lower shelf positions. Remove them from the refrigerator and arrange them as follows when setting up your unit.

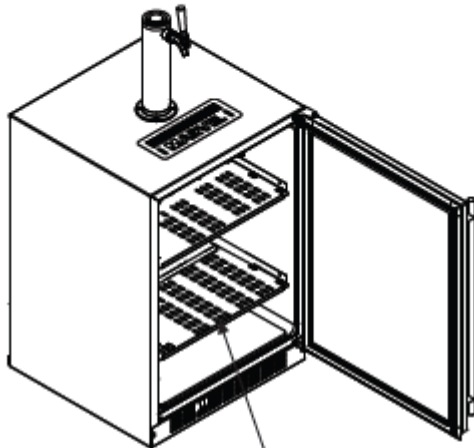

Figure 23 Two shelves

If you are not serving beer on tap, your keg dispenser can be used as a refrigerator by placing both shelves on the mounting brackets as shown in Figure 24. The shelves are marked upper and lower. The upper shelf should be placed in the top shelf position and the shelf marked lower should be placed in the bottom shelf position.



If you are using the appliance as a refrigerator for perishable foods, the set-point temperature should be set between 34°F and 42°F (1.2°C and 5.7°C).

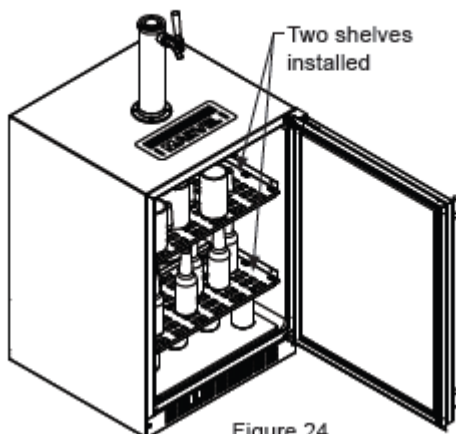
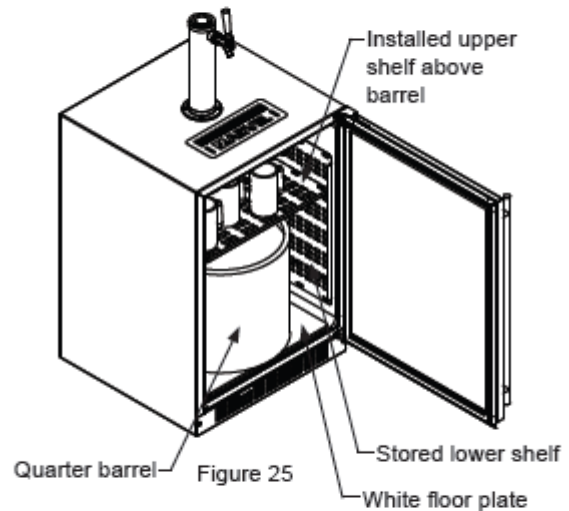

Figure 24

If you are using a quarter barrel of beer, you can add shelf space for keeping your mugs chilled. The quarter barrel must set on the floor, it cannot fit on the shelf, see Figure 25. Be sure the white floor plate is in the bottom of the interior compartment before positioning the barrel.



If you are using a half barrel (keg) or (2) 1/6 barrels, place the two shelves on the right side of the keg dispenser on the two mounting hooks for storage. (See Figure 26). Be sure the white floor plate is in the bottom of the interior compartment before positioning the barrel(s).

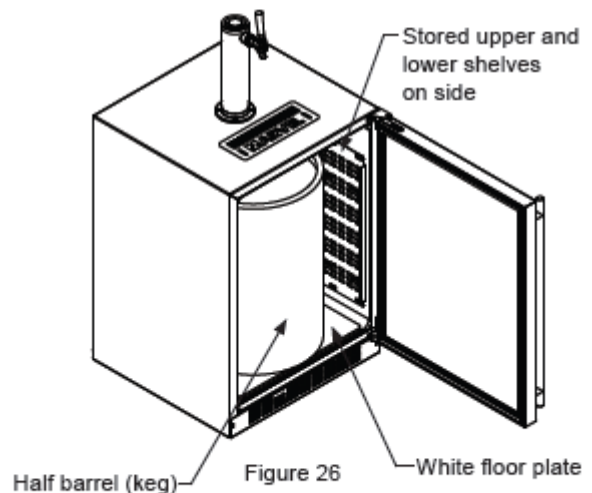

Figure 26

This beer dispensing unit will support one half (½) barrel or one quarter (¼) barrel. The double draft tower units can support two sixth (⅙) barrels of beer. See chart below for quantity of beer in each barrel size.

	Barrel Sizes		
	1/6 barrel	1/4 Barrel	1/2 Barrel
Height	23 ⁹ / ₁₆ " (59.2 cm)	14 ¹³ / ₁₆ " (37.6 cm)	23 ⁹ / ₁₆ " (59.2 cm)
Diameter	9 ¹ / ₄ " (23.5 cm)	17" (43.2 cm)	17" to 17 ¹ / ₄ " (43.2 to 43 cm)
Gallons	5.23	7.75	15.5
#12 ounce Glasses	53	82	163

Table C

Keg Size	#of kegs per 5 pound CO ₂ Tank
5 gallon Corny	15 to 22
1/6 barrel	14 to 21
1/4 Barrel	10 to 14
1/2 Barrel	5 to 7

Table D

Tap Equipment and Assembly

Your dispensing kit includes the following parts:

- Polished stainless steel tower with clear beer line (single or double dispense)
- Tower Gasket
- Phillips oval head screws
- Knob for Tower (Faucet Handle)
- Keg coupler(s)
- CO₂ regulator with red gas line(s) attached
- Empty 5 pound CO₂ tank
- Plastic clamp(s) large and small
- Faucet wrench



Tools required for installation:

Flat bladed screwdriver

Phillips screwdriver

Pliers

Adjustable wrench or a 1½" open end wrench

½" open end wrench



WARNING

CO₂ can be dangerous. If it becomes difficult to breathe and/or your head starts to ache, a high concentration of carbon dioxide may be present. Leave the area immediately.

- The CO₂ tank must always be connected to the regulator. Never connect the tank to the keg.
- The CO₂ tank must be securely mounted in the upright position. Secure it with the chain provided.
- Never drop or throw the CO₂ tank.
- Keep the CO₂ tank away from heat.
- Ventilate the area after a CO₂ leak.

1. Remove shelving and packaged components from the interior of the refrigerator before beginning the assembly process.
2. Take your empty 5 pound CO₂ tank to your local gas supply dealer to be filled. You can usually find them in your "yellow pages" under "Welding Supply" or "Fire Protection". One 5 pound tank can process many kegs (see table "D") Your dealer should supply you with a plastic washer every time the tank is filled.
3. Tower mounting (if you are installing the unit under a counter skip to step 4). If you are mounting the tower directly to the top of the refrigerator, first remove the four screws from the top of the refrigerator. Feed the clear beer line through the tower gasket and the large hole in the refrigerator top. Align the 4 holes in the tower with the 4 holes in the refrigerator top and secure the tower with the 4 screws removed previously. Skip to step 5.

Single Dispense Tower Kit

Connect **(A)** to **(A)**, etc.....

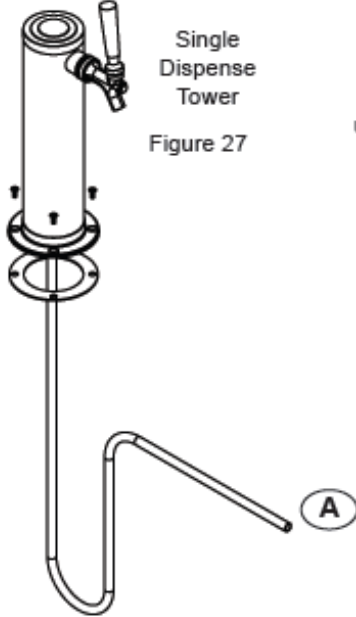

Single Dispense Tower
Figure 27

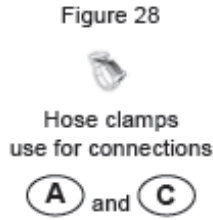

Figure 28

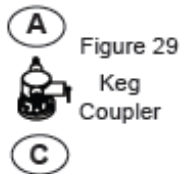
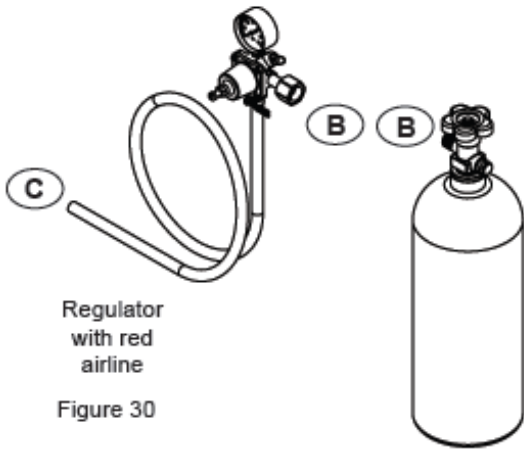

Figure 29
Keg Coupler



Regulator with red airline
Figure 30

5 Pound CO₂ Tank
Figure 31

Double Dispense Tower Kit

Connect **(A)** to **(A)**, etc.....

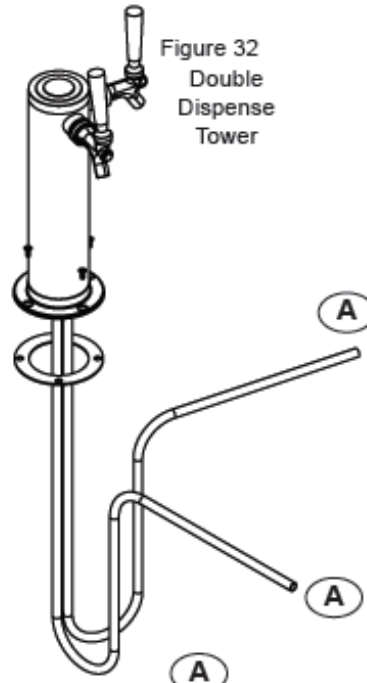

Figure 32
Double Dispense Tower

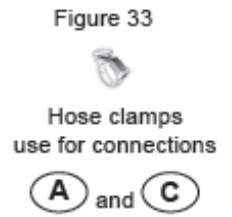

Figure 33

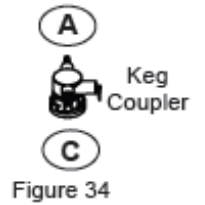

Figure 34

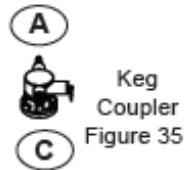
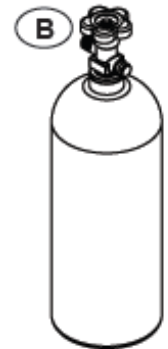
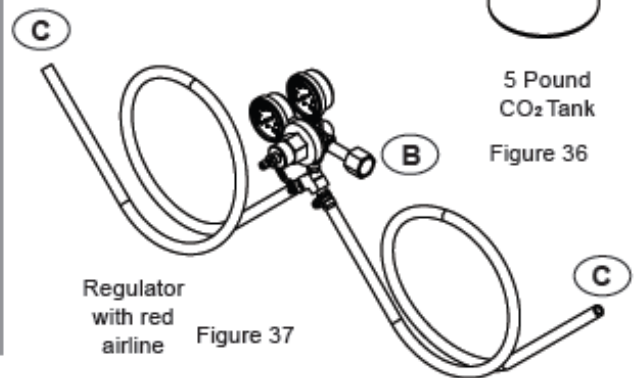

Figure 35
Keg Coupler



5 Pound CO₂ Tank

Figure 36



Regulator with red airline
Figure 37



CO₂ Regulator (Single Dispense Tower)

Your beer dispenser comes equipped with a 5 pound CO₂ tank and a single gauge regulator. The gauge reads the pressure being supplied to the beer keg. Follow the procedure below to adjust the pressure to 12 - 14 psi (0.8 to 1 bar) for lager beer or 9 - 12 psi (0.6 to 0.8 bar) for ale's.

To adjust the pressure (Single Gauge):

1. Close the shutoff valve at the bottom of the regulator.
2. Be sure the faucet handle is closed on the tower (see Figure 46).
3. Loosen the lock nut by turning \curvearrowright counterclockwise using the $\frac{1}{2}$ " open end wrench until loose, this will allow adjustment of the pressure adjustment screw.
4. With the flat bladed screwdriver turn the adjustment screw \curvearrowright clockwise to increase the pressure or \curvearrowleft counterclockwise to decrease the pressure.
5. Open the shutoff valve on the bottom of the regulator. The gauge reading may drop but will return very quickly.
6. Pull the ring on the keg coupler to allow the gas to flow momentarily.
7. Make any fine adjustments if necessary with the adjustment screw.
8. Tighten the locknut with the $\frac{1}{2}$ " open end wrench by turning clockwise \curvearrowright .

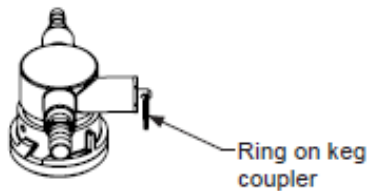

Figure 43

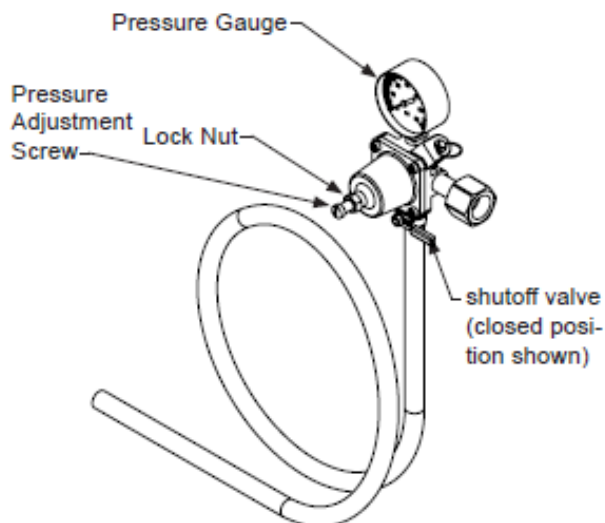

Figure 44 (Regulator for Single Dispense Tower)

CO₂ Regulator (Double Dispense Tower)

Your beer dispenser comes equipped with a 5 pound CO₂ tank and a dual gauge regulator. The lower gauge should be reading approximately 750 psi (52 bar) when the tank is properly filled and the tank is not in the refrigerator (at room temperature). The tank will read less when chilled. Use this lower gauge as an indicator of how much CO₂ you have left in the tank.

The upper gauge reads the pressure being supplied to the beer keg. Follow the procedure below to adjust the pressure to 12 - 14 psi (0.8 to 1 bar) for lager beer or 9 - 12 psi (0.6 to 0.8 bar) for ale's.

To adjust the pressure (Upper Gauge):

1. Close the shutoff valves at the bottom of the regulator.
2. Be sure the faucet handle is closed on the tower (see Figure 46).
3. Loosen the lock nut by turning \curvearrowright counterclockwise using the $\frac{1}{2}$ " open end wrench until loose, this will allow adjustment of the pressure adjustment screw.
4. With the flat bladed screwdriver turn the adjustment screw \curvearrowright clockwise to increase the pressure or \curvearrowleft counterclockwise to decrease the pressure.
5. Open the shutoff valve on the bottom of the regulator. The gauge reading may drop but will return very quickly.
6. Pull the ring on the keg coupler to allow the gas to flow momentarily.
7. Make any fine adjustments if necessary with the adjustment screw.
8. Tighten the locknut with the $\frac{1}{2}$ " open end wrench by turning clockwise \curvearrowright .

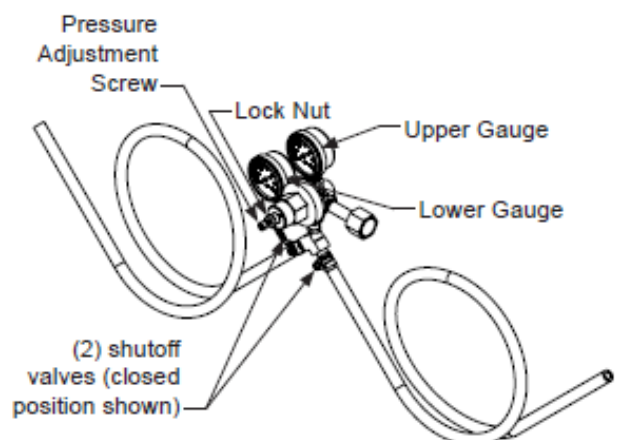
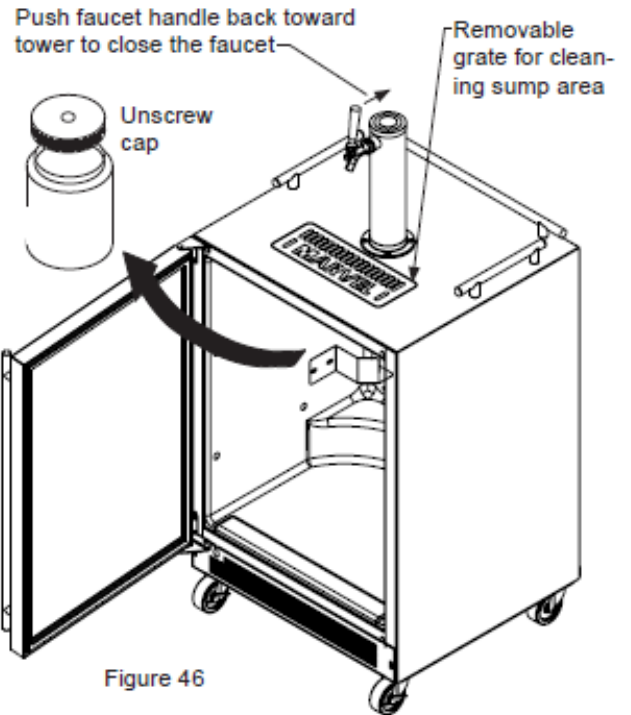

Figure 45 (Regulator for Double Dispense Tower)

Drain kit (All Models): The drain kit is shipped in place and ready to use. **To empty:** Pull drain hose out of bottle cap, remove bottle from unit, unscrew cap and discard waste and rinse bottle. Reinstall bottle in unit.



Cleaning the drain sump:

On a free standing beer dispenser remove the Marvel grate from in front of the tower, clean with soap and water and dry before reinstalling. Clean the sump area with soapy water and dry. (See figure 46).

On a built in beer dispenser remove the Marvel grate and counter top sump, clean with soap and water and dry before reinstalling. Clean the sump area with soapy water and dry. (See Figure 47).

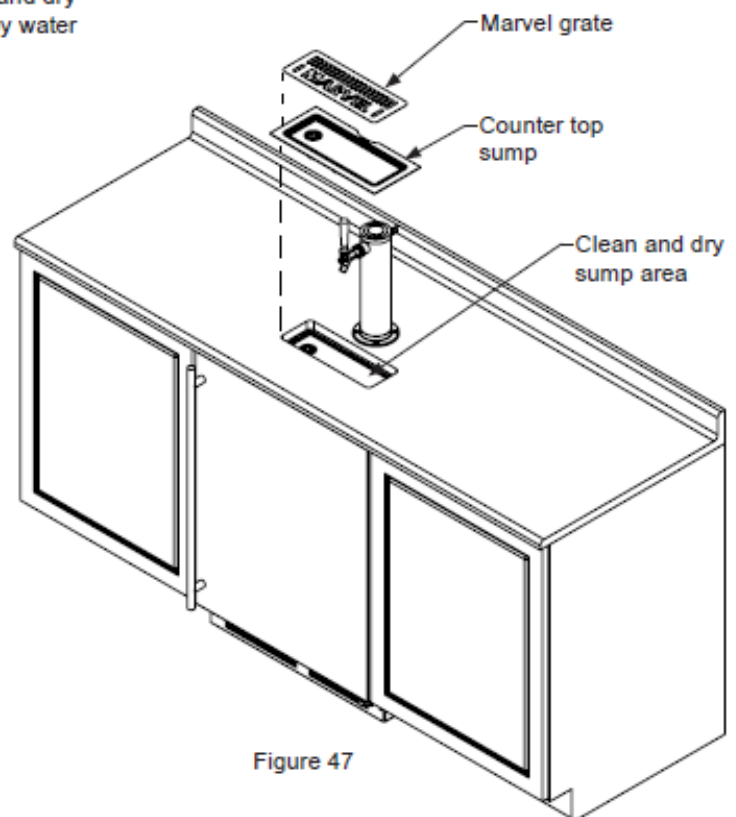

Cleaning and Maintaining Dispensing System

The dispensing system needs to be cleaned between usage to prevent spoilage and/or foul taste in your beer.

Tap Cleaning Kit

This is an optional item (part number 42242373) Kit includes everything to quickly clean tap. Includes cleaning solution, pump, mixing bottle, brush and wrench.

Faucet Cleaning

Turn off the gas supply with the shutoff valve(s) under the regulator (see Figure 44 or 45) and open the faucet to relieve the pressure. To remove the faucet from the tower use the spanner wrench provided. Place the pin on the wrench into the hole on the faucet collar and turn clockwise ~ to remove the faucet. (See Figure 49).

Remove the knurled cap from the faucet body just below the handle and pull the handle assembly from the faucet. This will allow the shaft to be removed from the back of the faucet, see Figure 48.

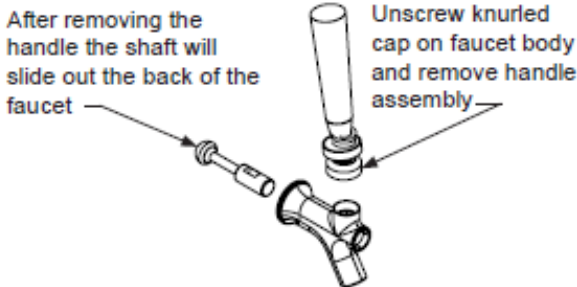

Figure 48

Soak all faucet parts in hot clear water or a solution of hot water and a sanitizing solution. Do not use soap.

Reassemble faucet, assemble faucet to tower (be sure faucet is in off position), and turn on gas valve.

Keg Coupler Cleaning

Remove the keg coupler from the keg if necessary. Close the gas valve(s) below the regulator, remove both the red gas line(s) and clear beer line(s) from the keg coupler(s) by removing the plastic hose clamps (See Figure 51). Soak and brush the keg coupler in hot water or a sanitizing solution. Dry all parts and reassemble.

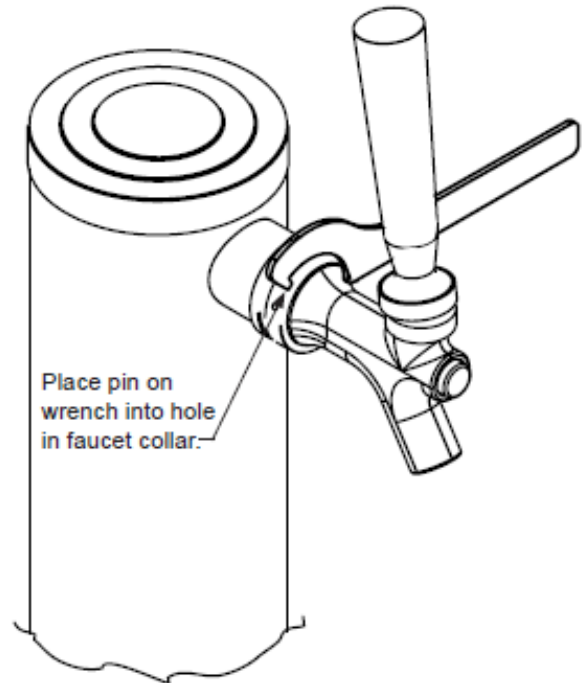

Figure 49

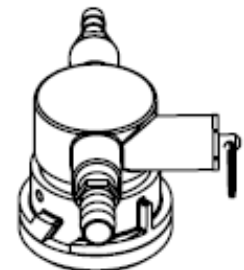

Figure 50

Hose clamps can be released by a lateral movement to the head.



Figure 51

Section 15: Dual Zone

15.1: User Interface Control

- Refer to Section 5.4 of this manual for more specific control reference



User Interface Display: Features dual compartment temperature set point option on display.



15.2: Operation

TEMPERATURE CONTROL OF THE DUAL ZONE COMPARTMENTS

Colder temperature is maintained per the SETPOINT for the lower compartment. Temperature is achieved and maintained by cycling the compressor on and off to reach the desired SETPOINT temperature.

Warmer (*upper zone*) temperature is maintained per the SETPOINT by opening and closing both damper doors along with the heat generated by the 20 watt AC heater located behind the upper compartment access cover.

A call for cooling will open up both compartment dampers for tempered cold air throughout the unit. **NOTE:** When the upper damper is open for cooling, the small air louvers in the upper compartment will be closed, as evidence of the grey foam tape sealing against the rear of the louver openings. The tempered air will be expelled through the circulation fan.

A call for heating in the upper compartment will close the upper damper into the lower compartment. **NOTE:** When the upper damper is closed for heat, the small air louvers in the upper compartment will open, as evidence of the grey foam tape opening away from the rear

louver openings. The warm air will be circulated throughout the upper cabinet through the upper circulation fan and return through the louvered opening at the bottom of the rear back panel.

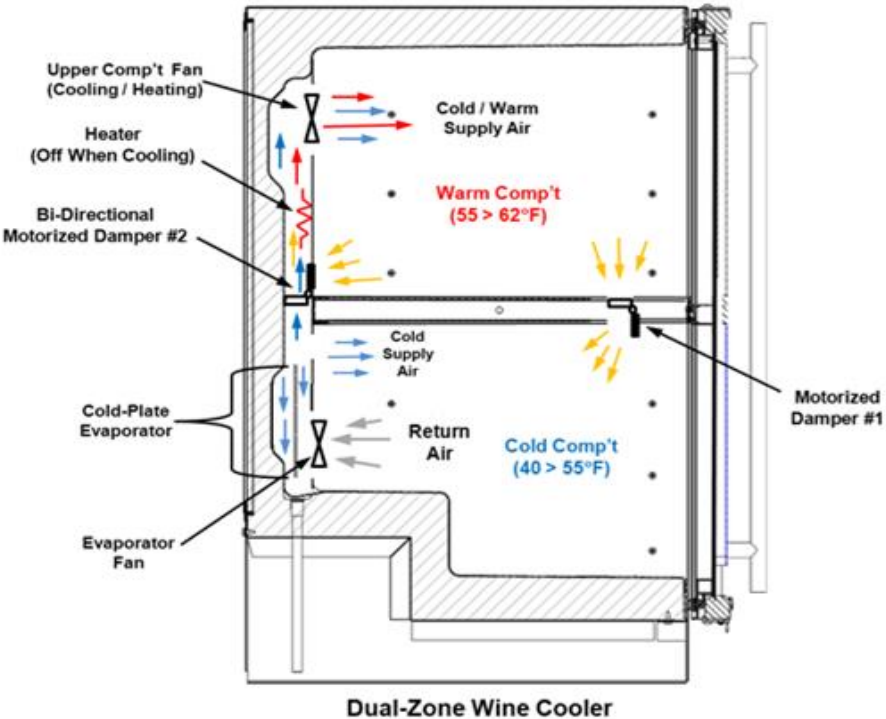

15.3: Characteristics



← **Upper Compartment:**
Temperature range is 55° to 62° F.

← **Lower Compartment:**
Temperature range is 45° to 55° F.



15.4: Dual Zone Compartment Air Flow

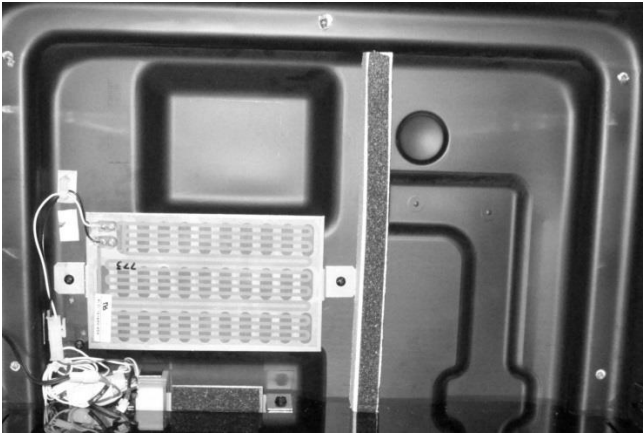

VIEW: Upper compartment with rear panel removed. *Center divider is in place.*

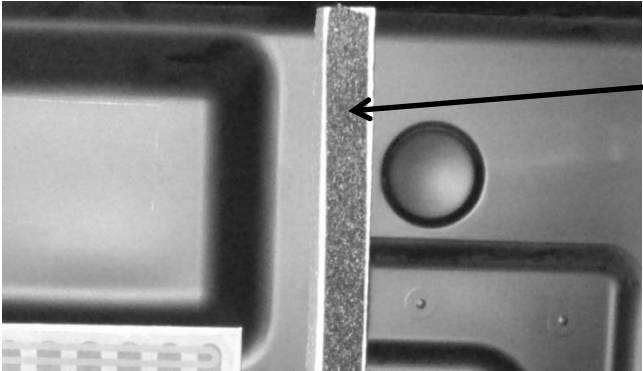

VIEW: Styrofoam air channel insert.



VIEW: Lower compartment with rear panel removed. *Center divider is in place.*



15.5: Divider Removal

- *This procedure would be required for an evaporator replacement.*

Prior to removing the center divider the back cover to the upper compartment must be removed, and the wire harnesses disconnected.

Mullion: Upper View



Mullion Bottom View

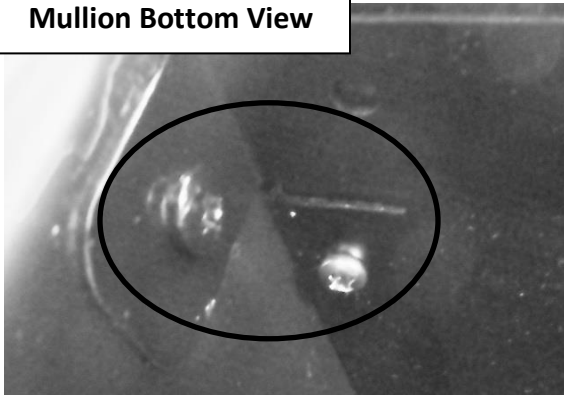

Remove both bottom and top screws on each side of mullion. The top screw must be removed so that the mullion face can be removed from the divider to obtain door clearance.



The dotted lines in the bottom photo show the point where the mullion edge and door will interfere if the divider is removed prior to mullion face removal.

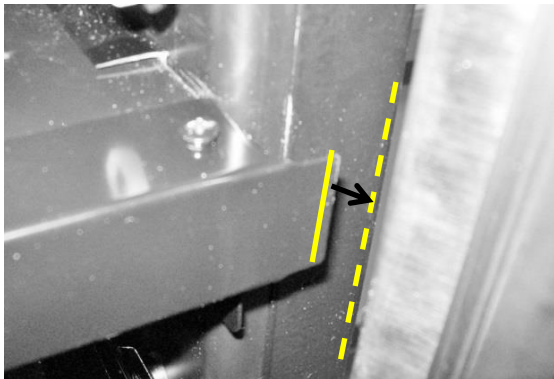

Once the mullion face is removed, the divider can be slid forward and out of the cabinet.



Remove the cover which isolates the electrical connectors.

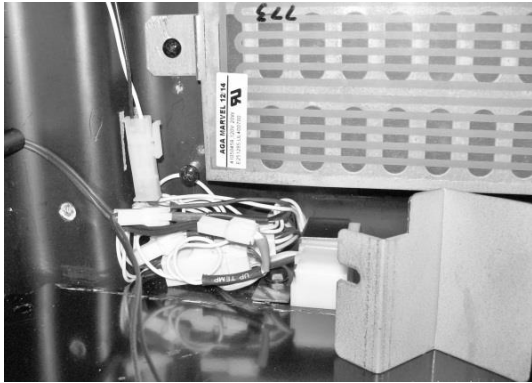

Disconnect wire

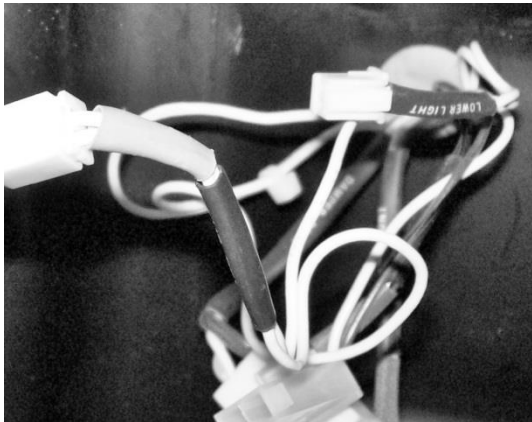

NOTE: Each wire with a connector is labeled with a piece of shrink wrap tubing in regards to its termination point.



Slide divider outward from cabinet.

15.6: Damper Operation

- The front damper is located in the front right hand side of the divider.
- The rear damper is located in the rear of the divider behind the back cover.
- Both damper positions are regulated by the need to cool or add heat into the upper (warmer) compartment.

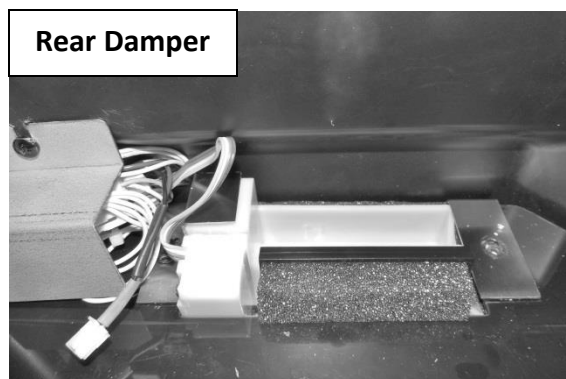
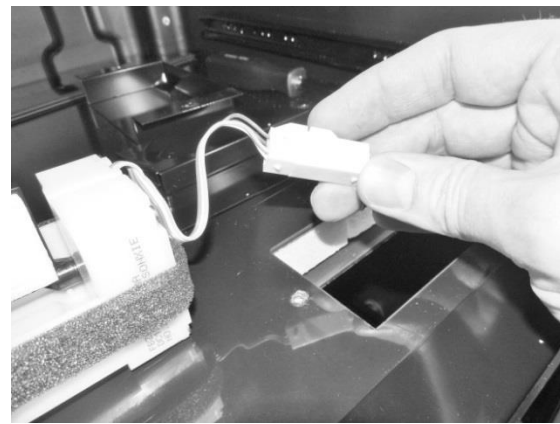
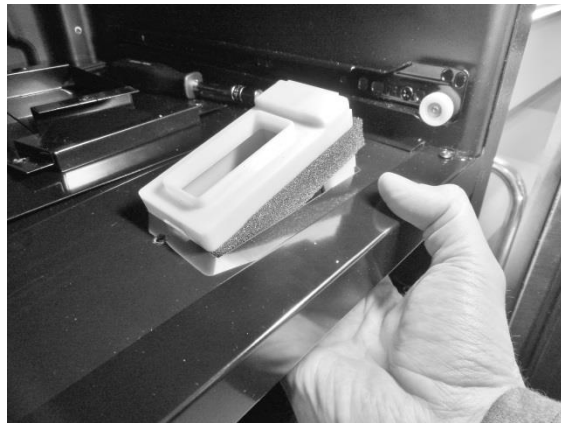
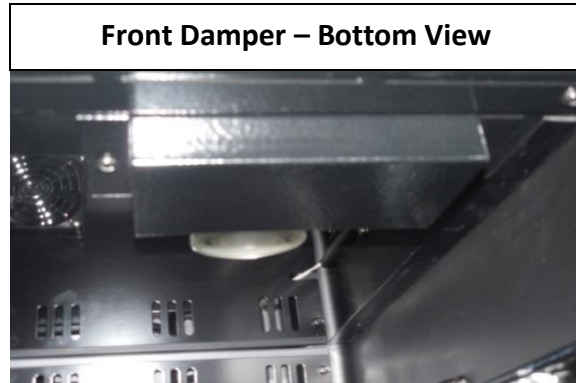

It is recommended to remove the divider to access the rear damper.

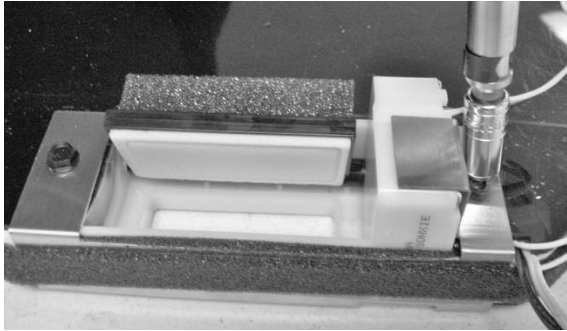

Remove screw on each side of damper bracket.



Cut the foam insulation on each side of damper bracket.

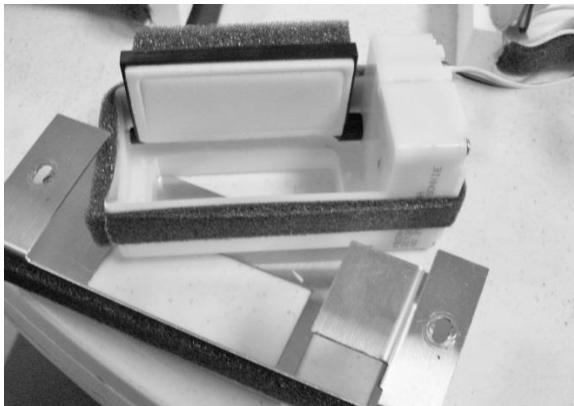

Remove damper from bracket.



Rear View: Rear damper in the open position.

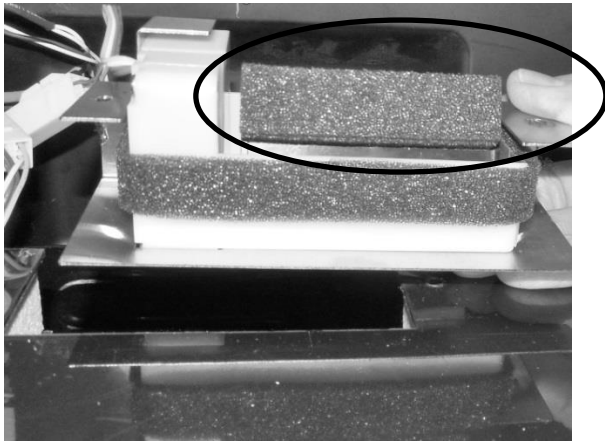

Front View: Rear damper in the open position: NOTE the insulation on the back of the damper door.

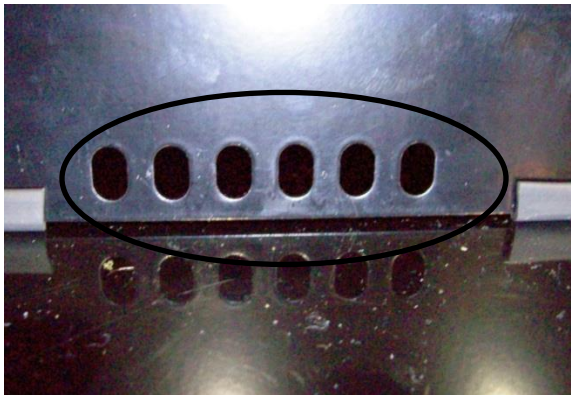

View from the Upper Compartment: The louvers on the back cover will be shut when the rear damper is in the open position. The insulation on the back of the damper door will close air from passing through.

The photo shows the upper damper closed to the lower zone. This is the orientation of the damper for the upper zone once it reaches its set point.

15.7: Compartment Fan Operation

- Upper compartment; blows air out into the compartment, circulates supply air into the compartment. The blade rotates in a clockwise rotation as you face the hub.
- Lower compartment; draws air out of the compartment, return air is brought back into the evaporator compartment to be reconditioned. The blade rotates in a counter-clockwise rotation as you face the hub.

Top Compartment

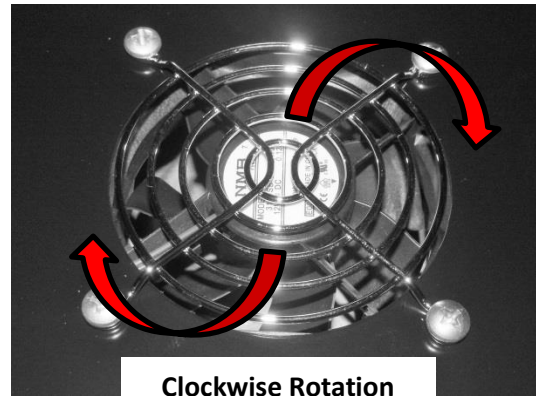

Bottom Compartment

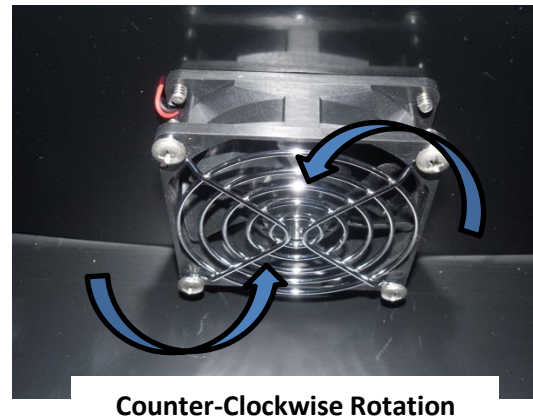

15.8: Heater Operation

- The heater controls return air to circulate into the upper compartment to maintain desired set point temperature.
- A call for cooling in the upper (warmer) compartment opens both damper doors and disables the heater.
- A call for heat in the upper (warmer) compartment closes both damper doors and enables the heater.
- The heater is disabled when the ambient thermistor senses a temperature excessive to 85°F.
 - This prevents excessive compartment temperatures.

To access the heater (upper compartment) remove the 5 screws securing the rear panel cover. Once this is done, remove the metal wire cover to access the fan connector. Once disconnected the rear panel can now be removed from the compartment.



Upper Compartment Heater: Used to control and maintain the temperature of the upper zone.



A replacement heater will appear as seen to the left. The heater will come attached to a replacement bracket.

15.9: Thermistors

All temperatures are monitored individually by 10K @ 25°C NTC sensors (thermistor).

The dual zone has three thermistors, one for each compartment and a third mounted outside the unit to sense ambient temperatures.

The **ambient thermistor** is located behind the toe grill and secured to the top of the machine compartment. It is centrally located in the condenser intake air. If the ambient thermistor senses a temperature above 85°F, the heater located in the upper compartment will be disabled.

Upper View – thermistor is located on left hand side.



Upper Thermistor Location

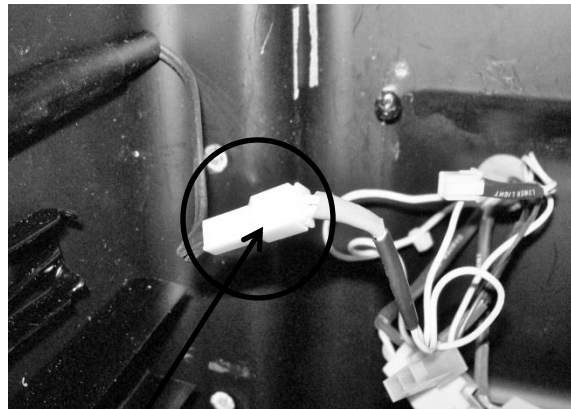

Upper Thermistor Disconnect

Bottom View – thermistor is located on right hand side.

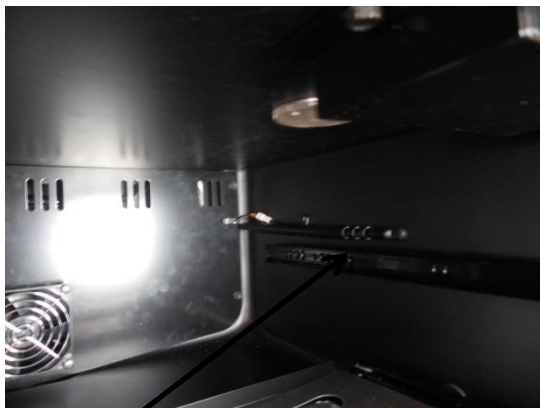

Lower Thermistor Location

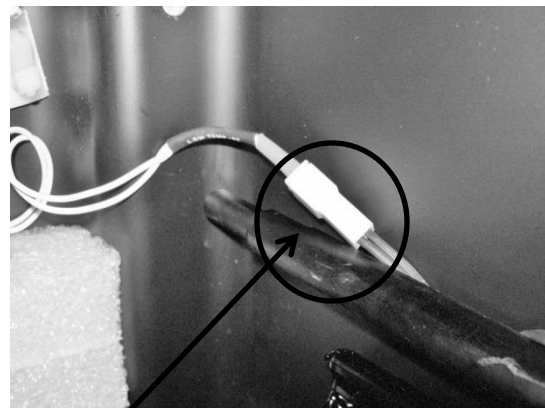

Lower Thermistor Disconnect

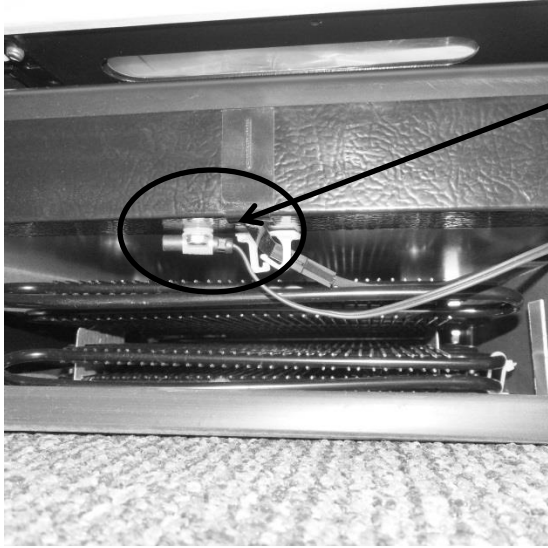

Location of ***ambient thermistor*** is located behind the toe grill and secured to the top of the machine compartment, centrally located in the condenser intake air.

15.10: Evaporator Access

- To access the evaporator (lower compartment) remove the 4 screws securing the evaporator cover. Once the cover is removed the top of the cover can be lowered. At this time, reach behind the cover and disconnect the evaporator fan. The cover can now be removed from the compartment.

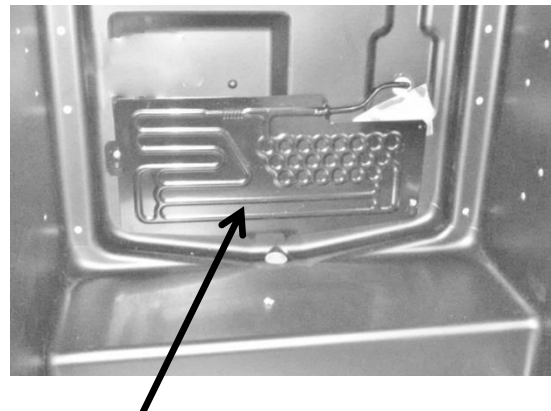
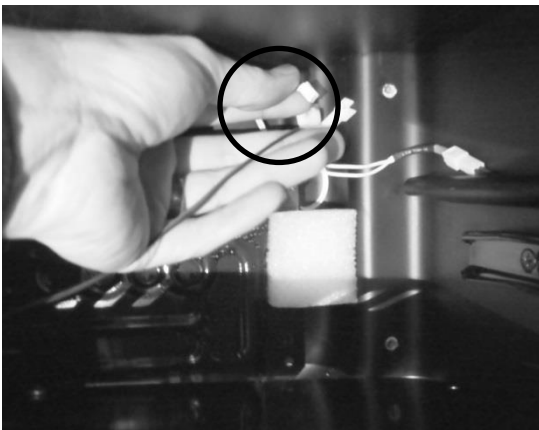

The evaporator is located behind the bottom back panel.

15.11: Interior LED's

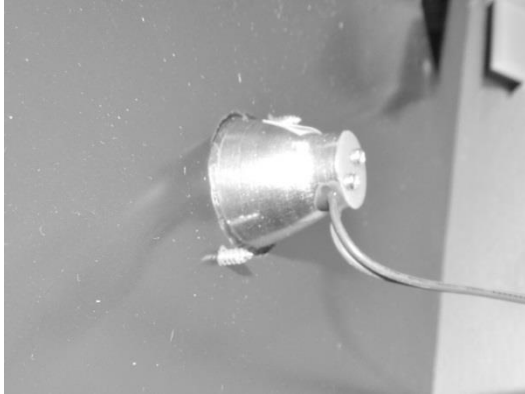

This is a photo of the bottom compartment LED. It was taken after the divider was disassembled. It references the need to carefully finger tighten the bulb when replacing. No clips or backers are used for assembly.

15.12: Defrost / Drip Time

When defrosting (dEF), the user interface display will appear as seen below:



Defrost can be achieved either automatically or manually. A manual defrost can be activated by holding the minus and lock keys simultaneously for a period of three seconds. Once defrost is activated the Use Interface will flash “dEF” three times before showing an uninterrupted “dEF”. More information is available in Section 5.

The Dual Zone does not have a true defrost time. Defrost is achieved by an extended compressor “Off” time. This compressor “Off” time is called “drip time”.

The dual zone does not have a termination thermistor attached to the evaporator plate to terminate defrost. The defrost time is programmed into the control board for a period of 30 minutes; this is called “**drip time**”.

Another difference between the dual zone and other Marvel under counter appliances is the length of “DRIP TIME” allowed. The drip time is associated with defrost “Off” time in that it allows the moisture to clear from the evaporator plate to eliminate refreezing once the compressor restarts.

The defrost cycle is pre-programmed into the main power board and is not adjustable. The factory default is 6 hours of accumulated run time and begins at the conclusion of the compressor on cycle. The beginning of the next defrost cycle starts after time expires from the previous defrost event.

15.12.1: Defrost Component Sequence

1. The **heater** cycles between on and off depending on the call for cooling load (unless ambient temperature exceeds 85°F).
 - a. A call for cooling in the upper (warmer) compartment opens both damper doors and disables the heater.
 - b. A call for heat in the upper (warmer) compartment closes both damper doors and enables the heater.
2. The **compressor** shuts off at the initiation of the defrost cycle.
3. Both **upper** (Photo A) **and lower** (Photo B) **compartment fans** will be operative.

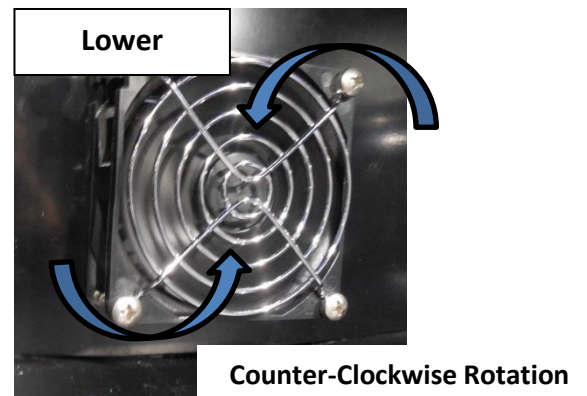
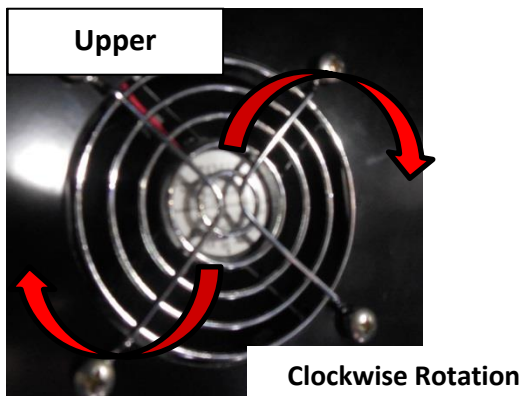

4. The **rear damper** is open from the heater section to the evaporator section (Photo C); but closed to the top compartment to the heater (Photo D).

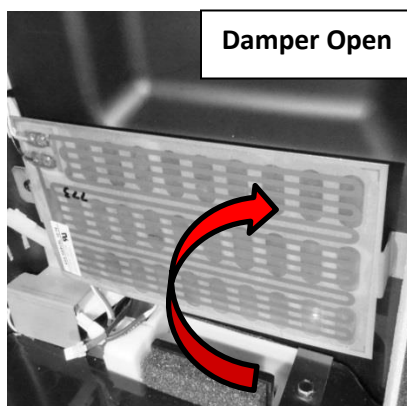

5. The **front damper** remains open, to circulate air from the lower compartment to the upper compartment (Photo E).

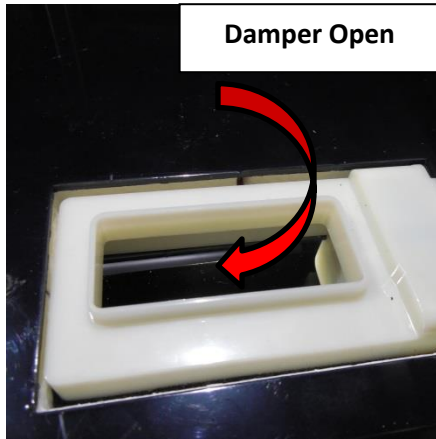

The photo below shows water droplets starting to build up on the evaporator plate.

NOTE: *This photo does not represent a failure condition as it appears.*

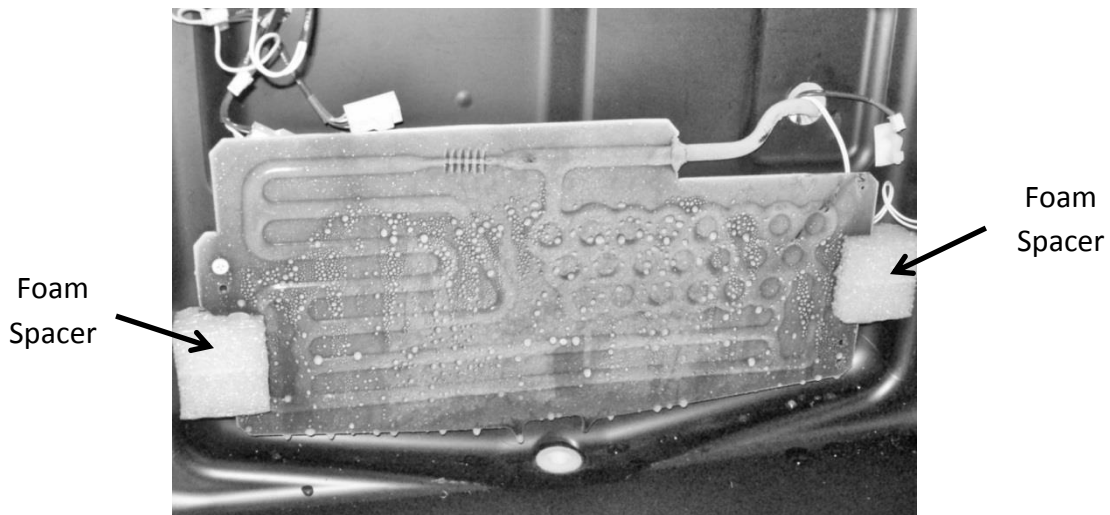

15.13: Refrigeration and Mechanical

The basic refrigeration and mechanical operation and assembly are not unlike that discussed earlier in this manual. This information can be reviewed in chapters 3 and 4.

Section 16: Refrigerator Freezers

16.1: User Interface Control



User Interface Display: Features dual compartment (refrigerator and freezer) temperature set point option on the display.



16.2: Operation

TEMPERATURE CONTROL OF THE REFRIGERATOR AND FREEZER COMPARTMENTS

The Aurora Intuit control regulates the refrigerator and freezer compartment temperatures separately.

Freezer temperatures are monitored by a thermistor located on the upper left hand side of the tempered compartment. The compressor will run until the thermistor senses the desired “Freezer Set Point” on the user interface, then shuts off.

The refrigerator temperature is also thermistor monitored; the thermistor is located mid-wall on the right hand side of the compartment. The thermistor works in conjunction with a

motorized damper; this damper is located on the bottom rear wall separating the freezer and refrigerator compartments. When the refrigerator compartment thermistor senses temperatures above the “Refrigerator Set Point” on the user interface, the damper will open. The open damper allows for cold air to be circulated from the evaporator, through the freezer door, into the refrigerator, and back through the damper to satisfy the need for cooling. Once the refrigerator thermistor is satisfied, the damper will close.

The top of the freezer compartment door has a narrow slot that is used to supply tempered air from the freezer compartment into the refrigerator compartment. The air is then circulated through the refrigerator compartment and returned through the open damper into the evaporator compartment to be recirculated after it passes through the evaporator.

Both the refrigerator and freezer fans run simultaneously when the compressor is running, both are inoperative during the compressor off cycles and also when the cabinet door is opened.

When running, the freezer fan pressurizes the freezer compartment and forces air into the refrigerator compartment through the slot located in the top of the freezer door. Then the fan is inoperative, very little air migrates from the freezer to the refrigerator compartment.

The refrigerator fan is located in the rear left hand corner, directly underneath the freezer compartment. Its purpose is to circulate air from underneath the freezer section, upwards and around the shelving and back through the return air damper.

16.3: Characteristics

All control functions are identical to those incorporating the ***Aurora Intuit Control***. Reference to section 5.4 of this manual will familiarize control navigation.

- Colder compartment temperature is maintained by cycling the compressor on and off. Internal cold compartment temperature is monitored by the compartment thermistor.
- Warmer compartment temperature is maintained by opening and closing a damper door. A 300 watt heater is used for auxiliary heat.

WARNING: Prior to any electrical repair the appliance must first be disconnected from its power source.

ACCESSING THE EVAPORATOR COMPARTMENT



To access to the freezer / evaporator compartment, first remove the freezer door and frame assembly. This will total 6 screws, 5 on the inside perimeter of the door frame, another on the inside upper left hand corner.

16.4: Damper Operation

- 12VDC / bi-polar stepper motor

16.4.1: Damper Access

- Warmer compartment temperature is maintained by opening and closing the damper in conjunction of the 300 watt heater.
- Colder compartment temperature is maintained by cycling the compressor on and off.
- The damper to the fresh food compartment will close during defrosts. This serves as a dual purpose; it will concentrate more heat for clearing the evaporator while also eliminating any residual heat transferring back to the fresh food compartment.



Damper shown in the open position.

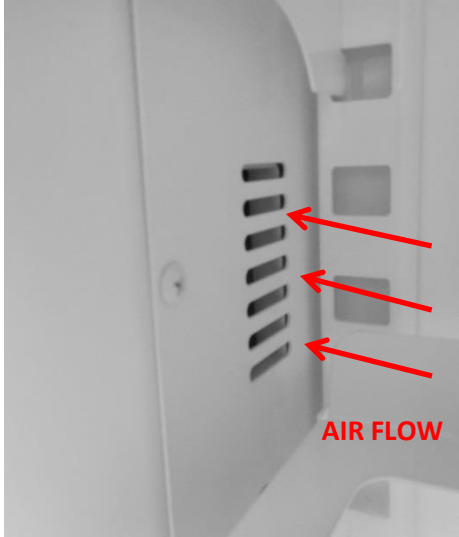

Air transfer damper is located behind this louver cover.



To access the damper, remove all three screws from the cover face.



The damper can be grasped and pulled out of the opening. Disconnect the wire connector to replace.

16.5: Fan Operation

16.5.1: Refrigerator Supply Fan

- 6-13.8 VDC

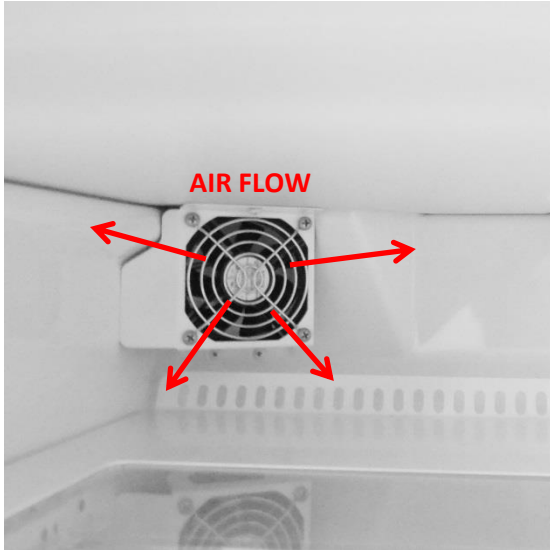

The refrigerator fan is located underneath the freezer compartment in the left rear corner.

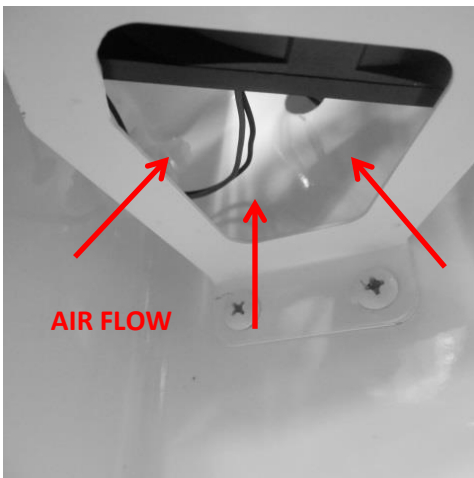

The bottom of the fan assembly is open to recirculated air from the compartment. The air is then pushed out into the compartment through the fan blade.

To replace the fan motor; the fan assembly must be removed and disassembled. Two screws are seen in the photo and one is in the upper flange (*not shown*).

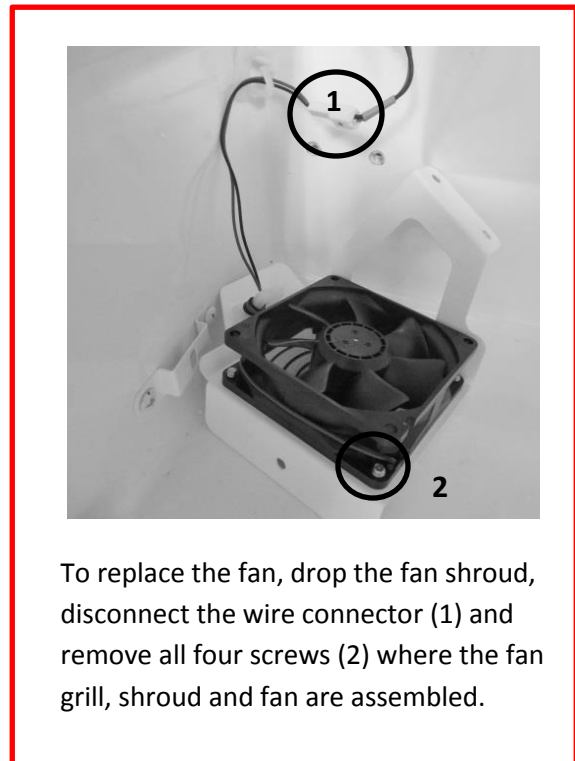

To replace the fan, drop the fan shroud, disconnect the wire connector (1) and remove all four screws (2) where the fan grill, shroud and fan are assembled.

16.5.2: Freezer Supply Fan

- 6-13.8 VDC

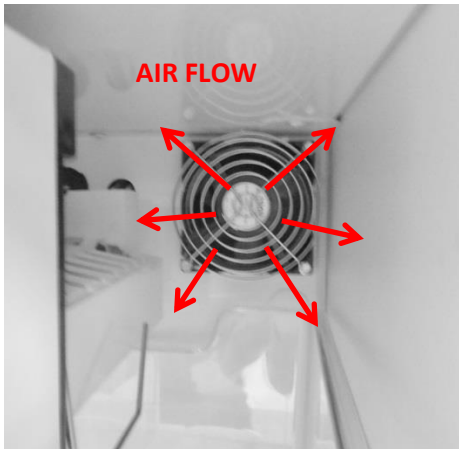

Supply Air Fan:
Circulates tempered
air into the freezer
compartment.

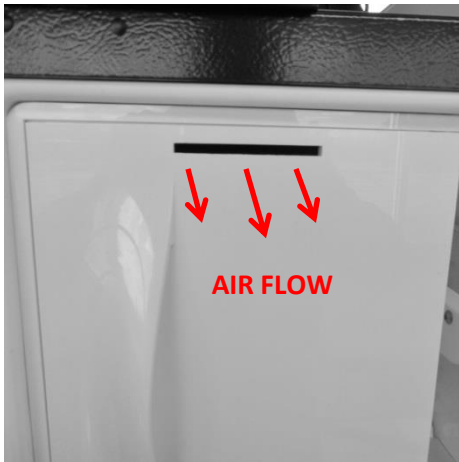

Supply air is
transferred from the
freezer into the
refrigerator section
through the slot in
the freezer door.

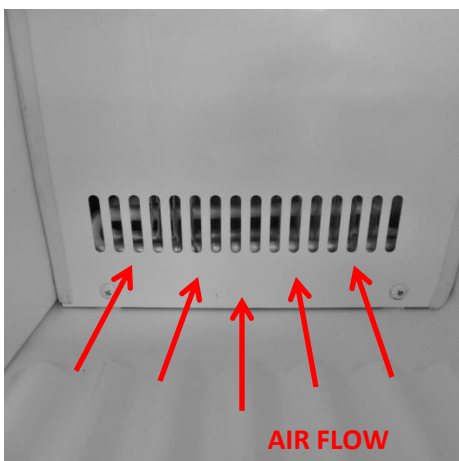

Louvers in the bottom of
the evaporator cover
accommodate return air
back to the evaporator
compartment.

16.6: Thermistors

16.6.1: Type

NTC, 10K @ 25°C, same as discussed in Section 6 of this manual; Use the same resistance charts located in Section 6.4.

16.6.2: Location

The freezer compartment thermistor is mounted on the upper left hand wall of the freezer side wall.

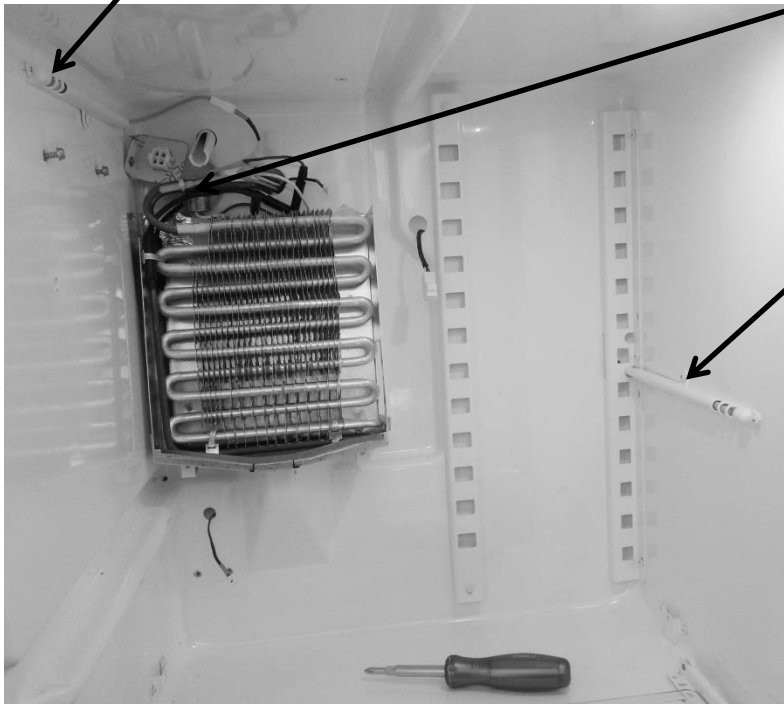

The defrost thermistor is mounted on the evaporator outlet. The evaporator is located behind the freezer compartment.

The refrigerator compartment thermistor is mounted on the mid wall on the right hand side of the refrigeration section.

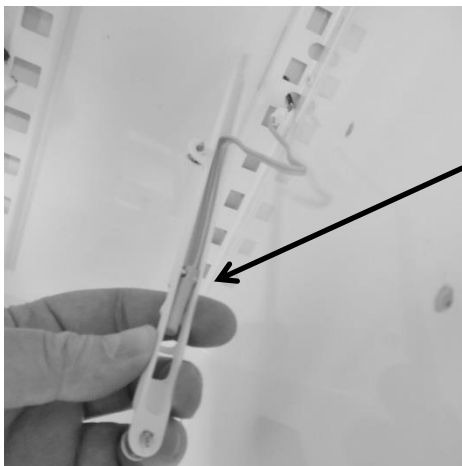

The thermistor bulb is located with the notch on the lower bulb which will nest inside the locating clip on the inside of the thermistor shield.

This view shows the thermistor bulb nested inside the shield.



16.7: Refrigeration and Mechanical

The basic refrigeration and mechanical operation and assembly are not unlike that discussed earlier in this manual. This information can be reviewed in Chapters 3 and 4.



The freezer partition can easily be removed for access to the evaporator section. Remove the three screws from the taps (2 on the top vertical and 1 on the left horizontal corner) where they are screwed into the cabinet.

NOTE: Refer to Section 19 for a Service Bulletin regarding replacement of the Evaporator / Heat Exchanger.

16.8: Evaporator

16.8.1: Type

- Fin and Tube.

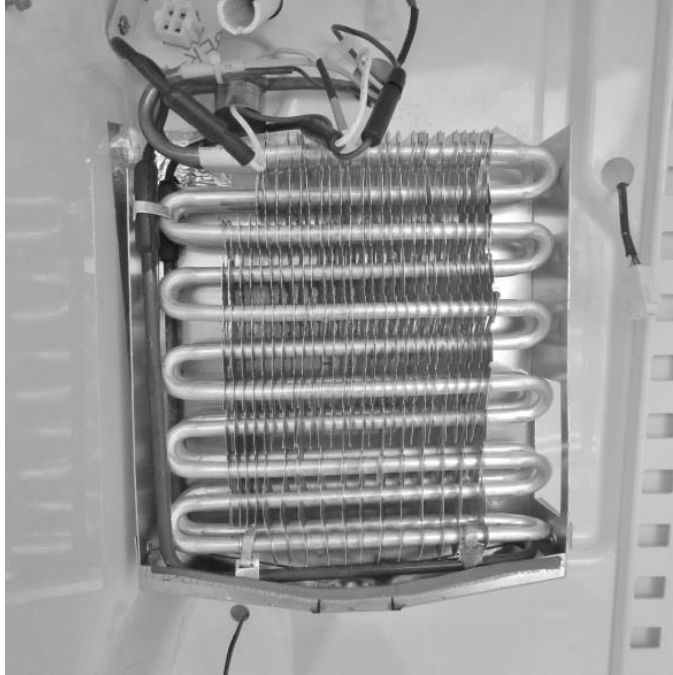

16.8.2: Location

- Located behind the freezer compartment.

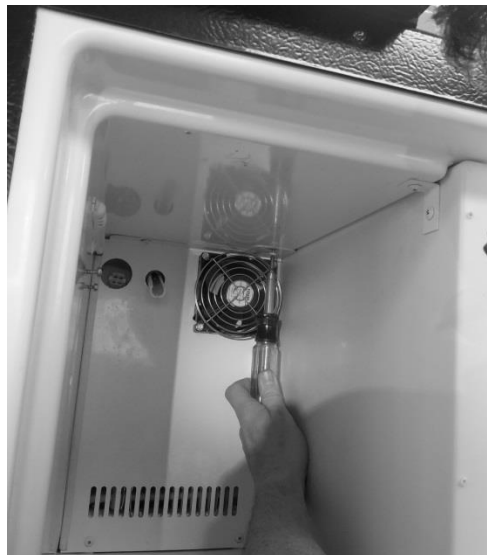

16.9: Defrost

When defrosting (dEF), the user interface display will appear as seen below:



Defrost can be achieved either automatically or manually. A manual defrost can be activated by holding the minus and lock keys simultaneously for a period of three seconds. Once defrost is activated the Use Interface will flash “dEF” three times before showing an uninterrupted “dEF”. More information is available in Section 5.

- **Defrosting** of the refrigerator freezer is unique from any of the Marvel and Marvel Under counter products. The components are very similar to those in a domestic full size refrigerator. The system includes a defrost heater, defrost thermistor, and a defrost termination thermostat.
- The damper to the fresh food compartment will close during defrosts. This serves as a dual purpose; it will concentrate more heat for clearing the evaporator while also eliminating any residual heat transferring back to the fresh food compartment.
- The timer function is programed into the main control board.
 - The defrost cycle is programmed to activate after 8 hours of compressor run time.
 - **NOTE:** In a 90°F ambient, a typical defrost time will average approximately 17 minutes from compressor off, to compressor on time.

16.9.1: Defrost Function

- The defrost cycle is activated by a timed event from the main control board. The programmed event will last for a 25 minute maximum defrost duration.

16.9.2: Defrost Heater

- The defrost heater has a 300 watt rating.
- The heater extends down the side and bottom of the fin and tube evaporator.
- The primary heater will cut out at 45°F.

16.9.3: Defrost Thermistor

- A defrost cut off thermistor acts as the primary method to terminate the defrost event.
- It is attached to the copper inlet tube of the evaporator.
- The thermistor will terminate defrost at 45°F.

16.9.4: Defrost Termination Thermostat

- The defrost termination thermostat acts as a secondary (safety) cut off for the termination of the heater at the conclusion of the defrost event.
- It is located at the copper outlet tube of the evaporator.
- The safety cut out of this termination thermostat is set at 47°F.

16.9.5: Defrost Drip Time

- Drip time is extended to the end of the defrost cycle to ensure that all water droplets are drained off the evaporator coil to prevent refreezing.
- The length of drip time is programmed at 10 minutes after the termination of the defrost thermistor.

16.10: ACCESS TO THE DEFROST COMPONENTS

WARNING: Prior to any electrical repair the appliance must first be disconnected from its power source.

16.10.1: Defrost Heater



Locate defrost heater connections.



To replace defrost heater, unplug the connections.

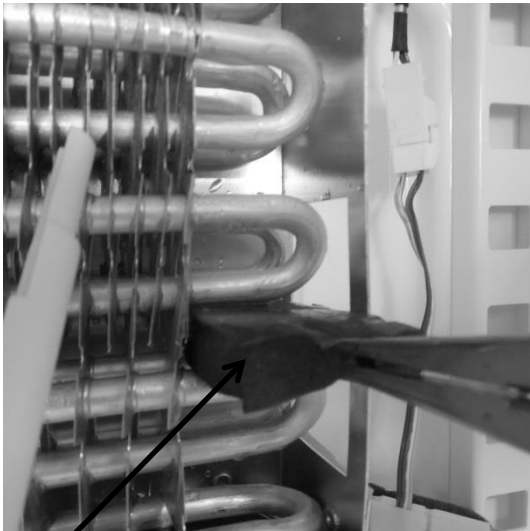

Remove the mastic evaporator spacers.

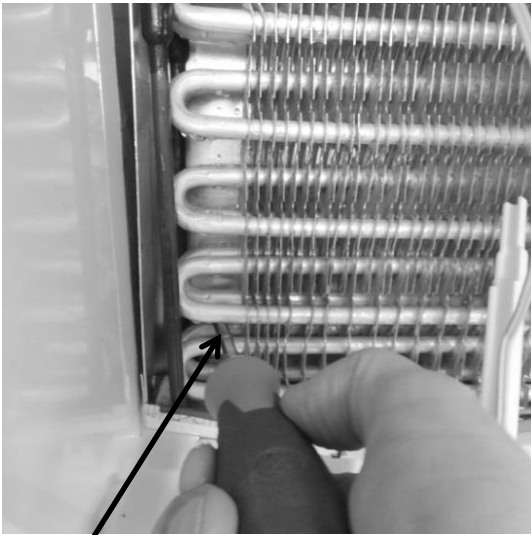

Remove the four screws that secure the drip pan to the liner wall



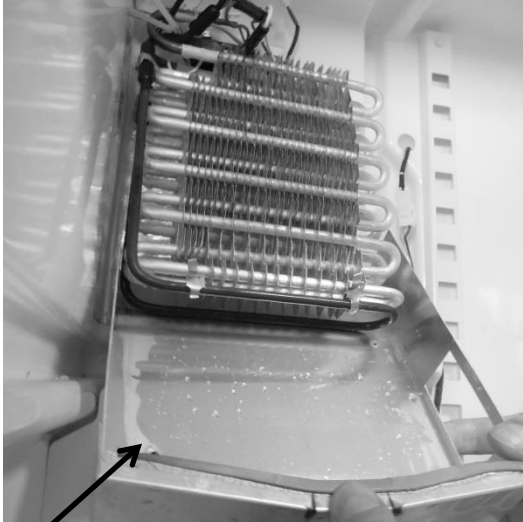

Slide the drip pan down away from the evaporator.

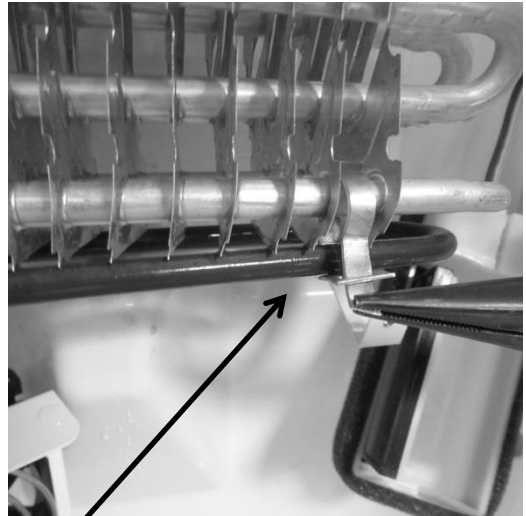

Remove the tin tie wraps that secure the heater next to the evaporator.

16.10.2: Defrost Termination Thermostat

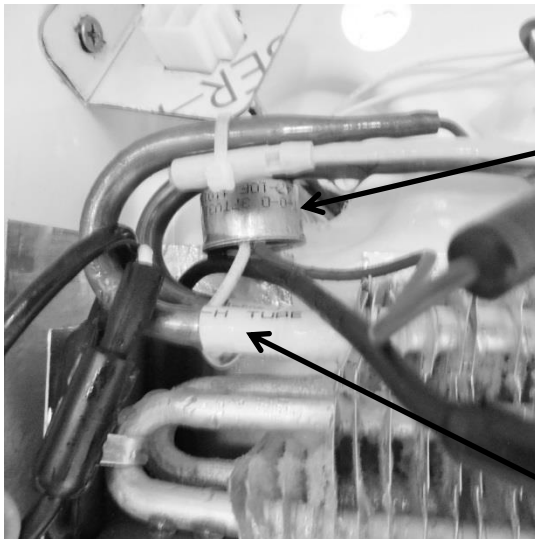

The Termination thermostat is located on the evaporator outlet.

The Defrost Thermistor is located on the evaporator inlet.

16.10.3: Defrost Thermistor

Also seen in the above picture; the thermistor is attached to the evaporator inlet and secured with a nylon zip tie.

To replace the defrost thermistor; disconnect the thermistor connector inside the evaporator compartment and replace.

16.11: RFI (Refrigerator Freezer- Ice Maker)



Freezer compartment: Includes an ice bucket and an ice maker with a fan in the upper rear corner.



This diagram represents the position of the ice machine level to turn the ice maker ON or OFF.

Lever Up: Ice Maker "OFF"

Lever Down: Ice Maker "ON"

16.11.1: Ice Maker

To remove the ice maker cover; insert a screwdriver into the bottom notch and lightly pry open.

16.11.1.1: Specs:

- 115 Volt/60 hertz
- Heater: 165 Watts / 80 Ohms
- Thermostat: Open @ 48°F (8.9°C) / Close @ 15°F (-9.4°C)
- Flow Rate: .34 GPM

WARNING: Prior to any electrical repair the appliance must first be disconnected from its power source.

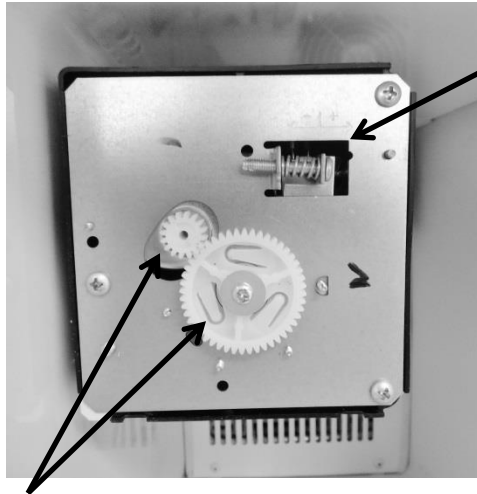

Ice maker with the cover removed.

The motor gear is the small gear on the top left.

The timing gear is the largest gear in the center.

Fill Adjustment

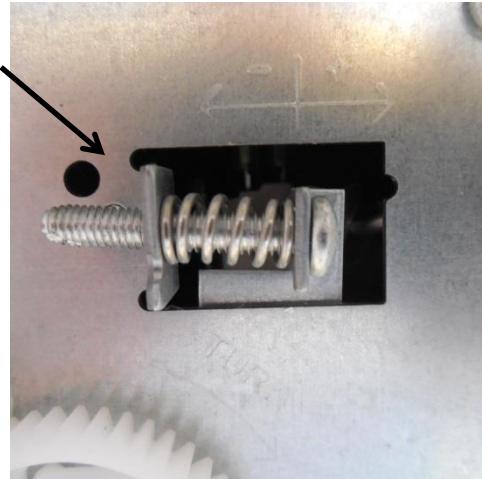

Adjusting the water fill can be accomplished by turning the adjustment screw clockwise (+) to increase or counter clockwise (-) to decrease.

16.11.1.2: Ice Maker Test Cycling

Test cycling of the ice maker can be achieved by turning the motor gear counter-clockwise until the holding switch circuit is complete. All components of the ice maker should function to complete the cycle.

The timing gear should not be turned as this will damage the ice maker.

16.11.1.3: Water Flow Volume

The water fill adjustment screw will change the fill volume by changing the fill time. One full turn is equal to 20cc (.68 oz.). The correct fill is between 90 and 120 cc (3.0 – 4.0 oz.).

When replacing a water valve, the fill volume must be checked.

These ice makers are factory preset for a flow rate of .34 gpm (gallons per minute).

PLEASE REFER TO THE SERVICE DATA SHEET INSIDE THE ICE MAKER COVER FOR ADDITIONAL INFORMATION.

16.11.2: Ice Maker Removal



To remove the crescent ice maker, the screws located inside the two upper mounting brackets need to be loosened. There is no need to remove these screws. A third screw on the bottom front of the ice maker body needs to be completely removed.

Lift the ice maker from the bottom and set the ice maker aside. This will expose the wire harness and water fill tube.



Remove the black wire grommet on the rear of the freezer cover. This will expose the connector for the ice maker harness.

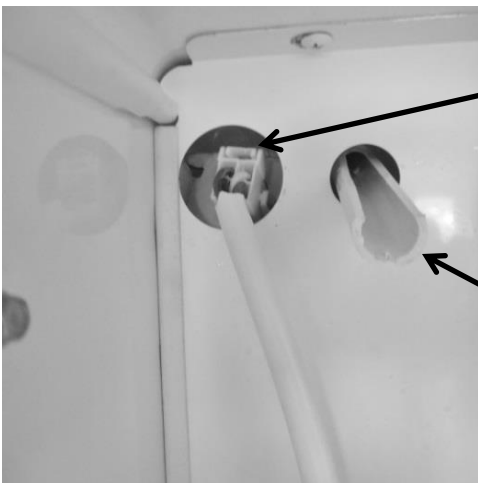

Grasp and squeeze the connector by the release until it disengages. Pull to disconnect.

The ice maker is now disconnected and can be removed.

Water fill tube.

16.11.3: Ice Maker Kit

Model RF (without icemaker) can have an AGA Marvel factory authorized Icemaker kit installed.

The part number for the AGA Marvel ice maker kit is S42418151-CLR.

This kit can be obtained through the AGA Marvel order desk. Call 1-800-223-3900 and follow the phone queue to the order department.

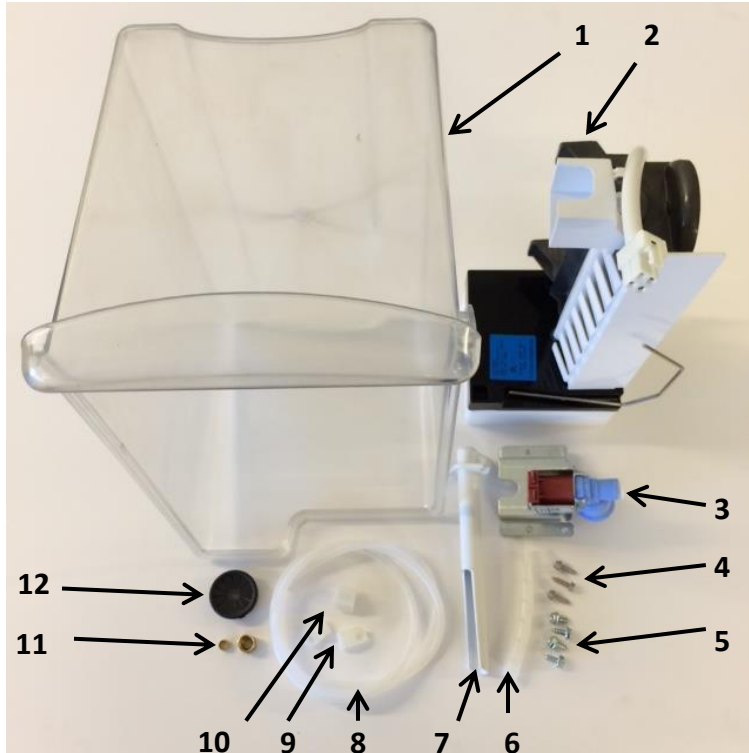

Kit Components

- 1) Ice Bucket
- 2) Ice Maker
- 3) Fill Valve
- 4) #8 x 5/8" HD SS Hex Screw
- 5) #10 x 1/2 AB Hex HD Screw
- 6) Tube Wrap
- 7) Fill Tube
- 8) 1/4" Plastic Water Line
- 9) P-Clamp
- 10) Fill Tube Nut
- 11) Nut and Ferrule
- 12) Plug Bushing
- 13) Installation Instructions

For installation the following tools will be required:

- 5/16" Nut Driver
- 1/4" Nut Driver
- 1/2" Open End Wrench
- 5/8" Open End Wrench
- Flat Blade Screwdriver

16.11.3.1: Ice Maker Kit Installation Instructions:

- Follow specific instructions included in kit.



Remove rear panel to machine compartment.

Connect wire harness inside of machine compartment to water valve.

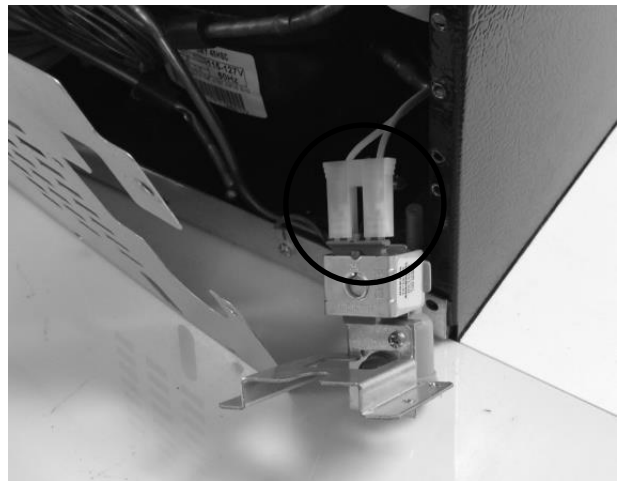

Attach water valve to rear cabinet flange. Replace cover to machine compartment.

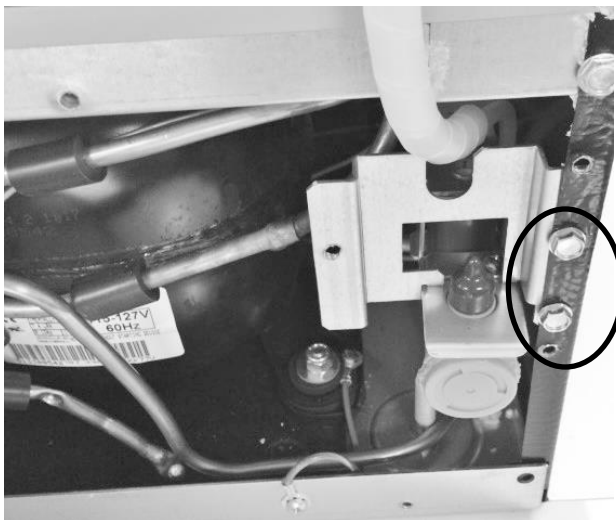

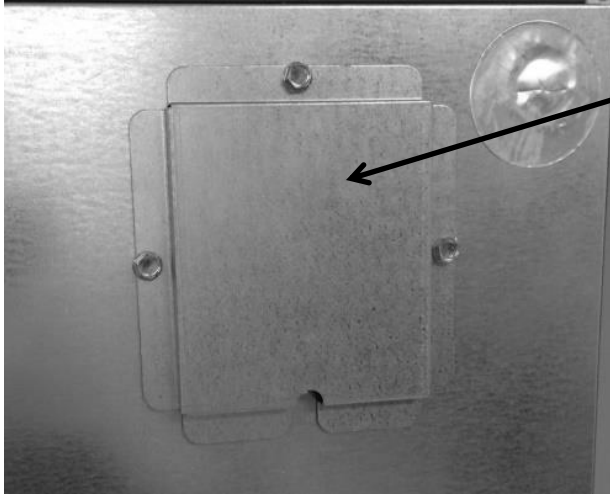

Remove access cover in top rear, right hand corner. Remove insulation under cover and keep for use later.

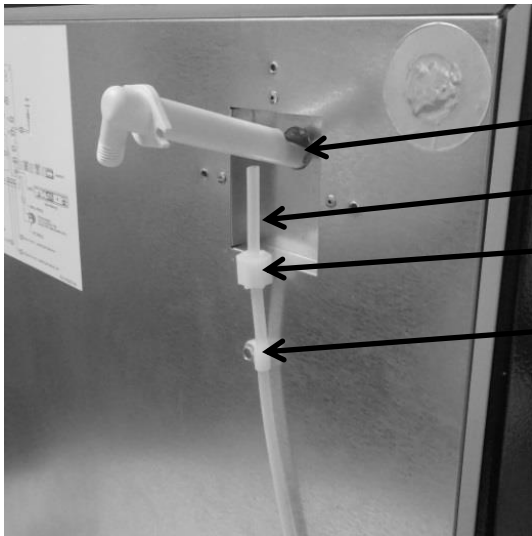

Water (fill) tube

Water line with compression fitting

Compression nut

P clamp

Insert fill tube; connect water line and compression nut. Secure fill tube with screws.

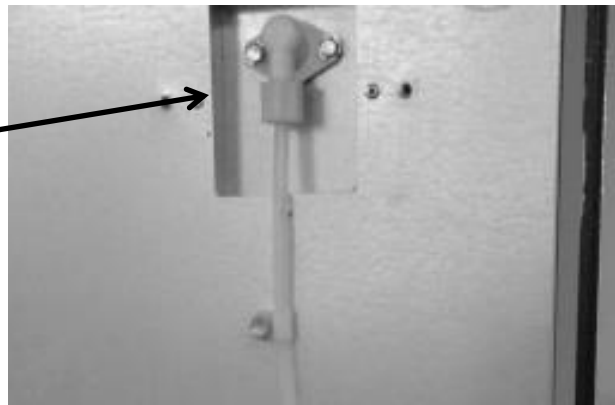

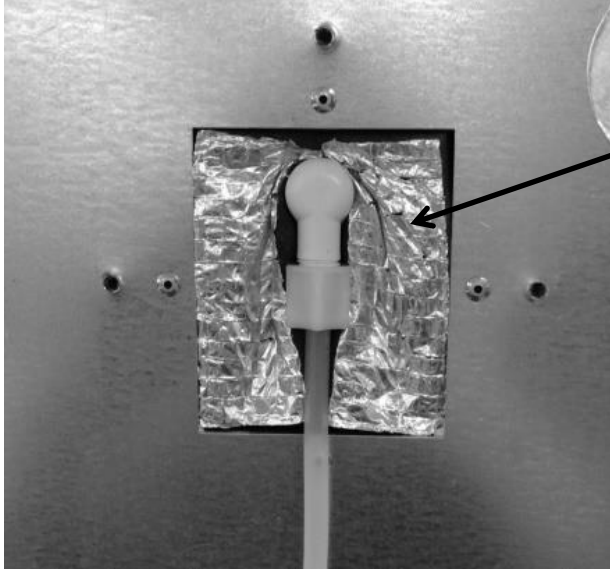

Replace insulation and access cover.

Remove three plastic screw plugs on left hand side wall in freezer compartment.

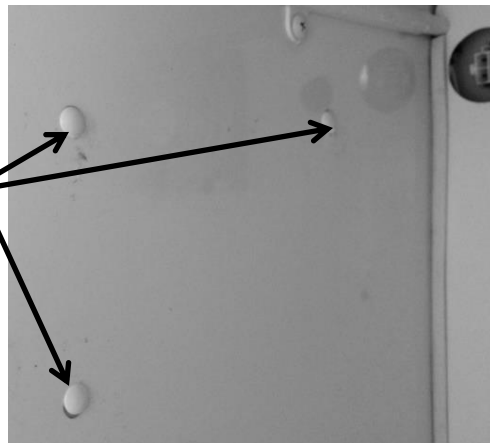

Install screws into the top two holes; leave room to set the ice maker into place on top of screws.

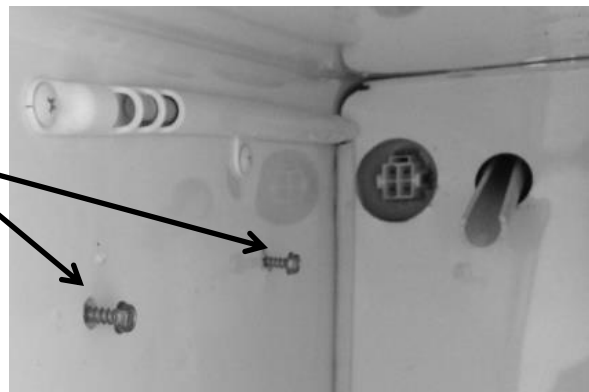

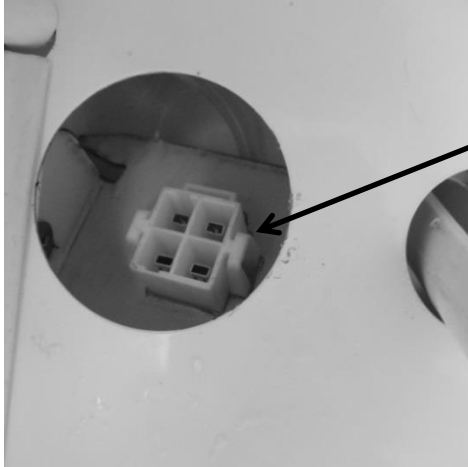

This photo shows the ice maker connection located in the evaporator compartment.

Place the plug bushing over the ice maker wire harness; smooth surface facing outward.



Push and snap the wire connector into place. Push the plug bushing into the rear cover panel.





Set the Ice maker on top of each of the (two) top screws and tighten.

Install the bottom screw into the bottom ice maker bracket and tighten.

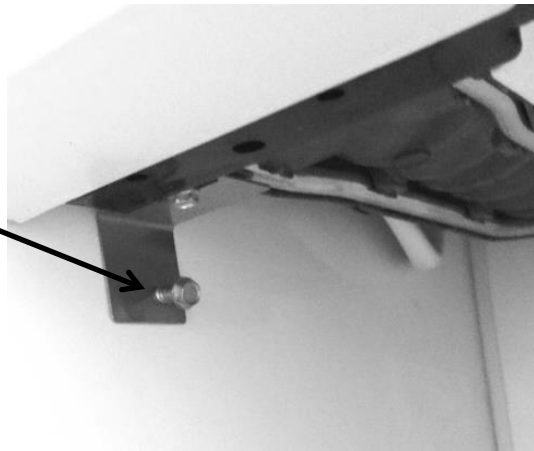

Access cover hiding the water fill tube

1/4" nylon water line with P-clamps

Water valve

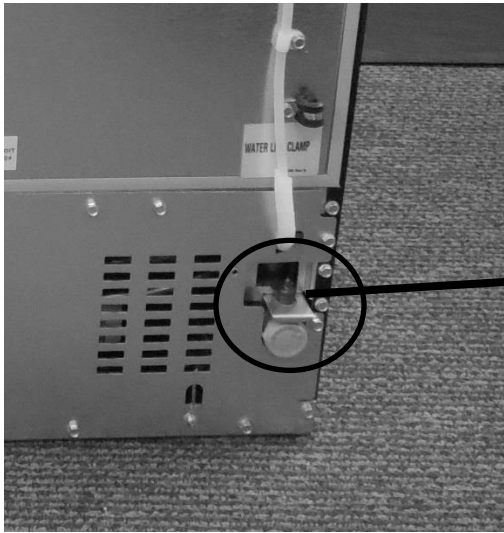

Supply water inlet: ¼" compression nut with coupling.

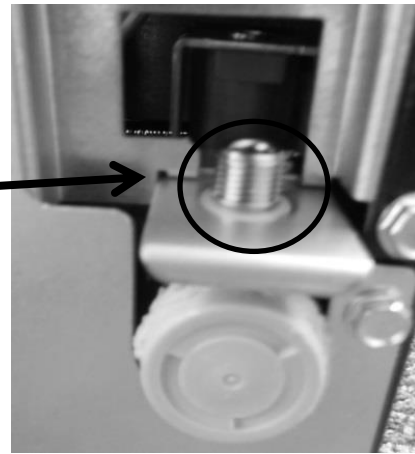

Install water supply line to the water valve, seat coupling and tighten the compression nut to the water valve.

Check for water leaks once supply water is reconnected.

16.11.3.2: Installation Schematic

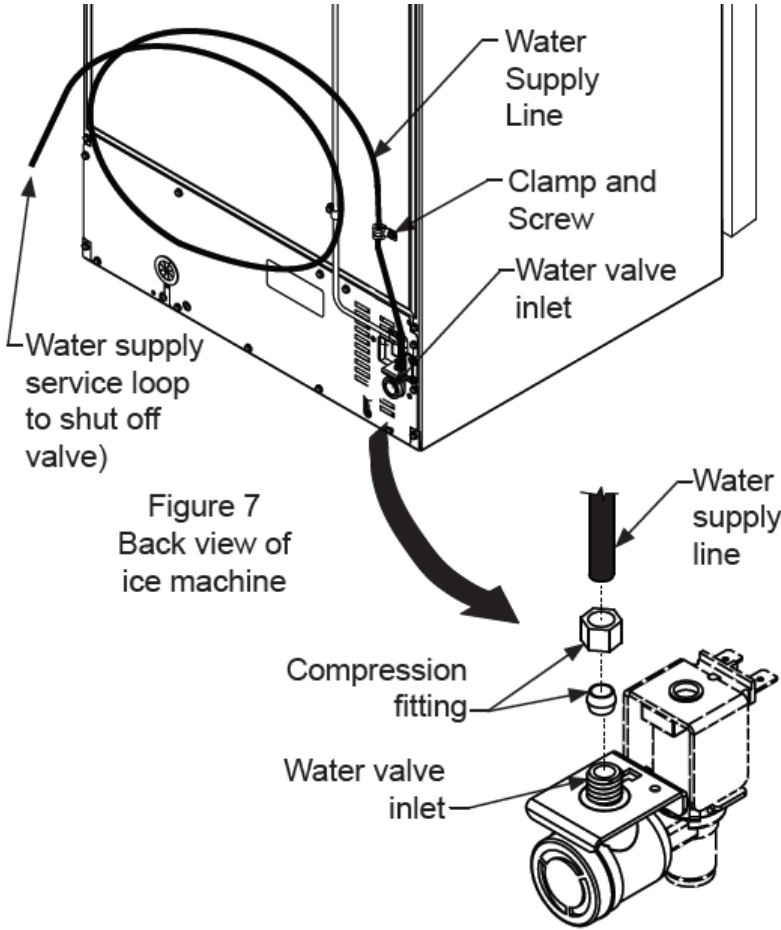

Section 17: Outdoor Models

17.1: Operation

Dynamic cooling utilizing a forced air condenser and interior circulation fans moves air effectively and efficiently. The **Prime** control system brings the *control interface display* inboard where it will not be affected by the elements of the outdoors. The *main control* board is located in the machine compartment. It is shielded by a *mylar* curtain behind the compartment access cover, this also protects from the elements of the outdoors. The entire cabinet and door are wrapped with a stainless finish.

17.2: Characteristics / Differences

Outdoor appliances are typically identified by the stainless steel wrapped cabinet and matching stainless door. The control is located in the interior of the appliance. In addition, the rear access panel in the machine compartment has a mylar curtain installed along the top edge to prevent water or moisture from entering.

17.3: Fans

Fan function and location is not unlike the indoor Marvel and Marvel Pro models. Air is drawn across the evaporator plate from the supply louvers and outward into the interior cabinet through the circulation fan. The blades rotate in a clockwise direction as you face the hub.



Evaporator Fan

NOTE: As of mid-August 2015, a rear fan guard was added to the fan assemblies on the outdoor beverage center and beverage dispenser models. The fan guard is to eliminate the possibility of wires getting caught in the fan blade from behind the coil cover.

The approximate serial number range is 20150824xxxH. This is an approximate date and some variation may be seen in the field.

An exploded view on the following page shows the assembly drawing of the coil cover components along with both the front and rear fan guards.

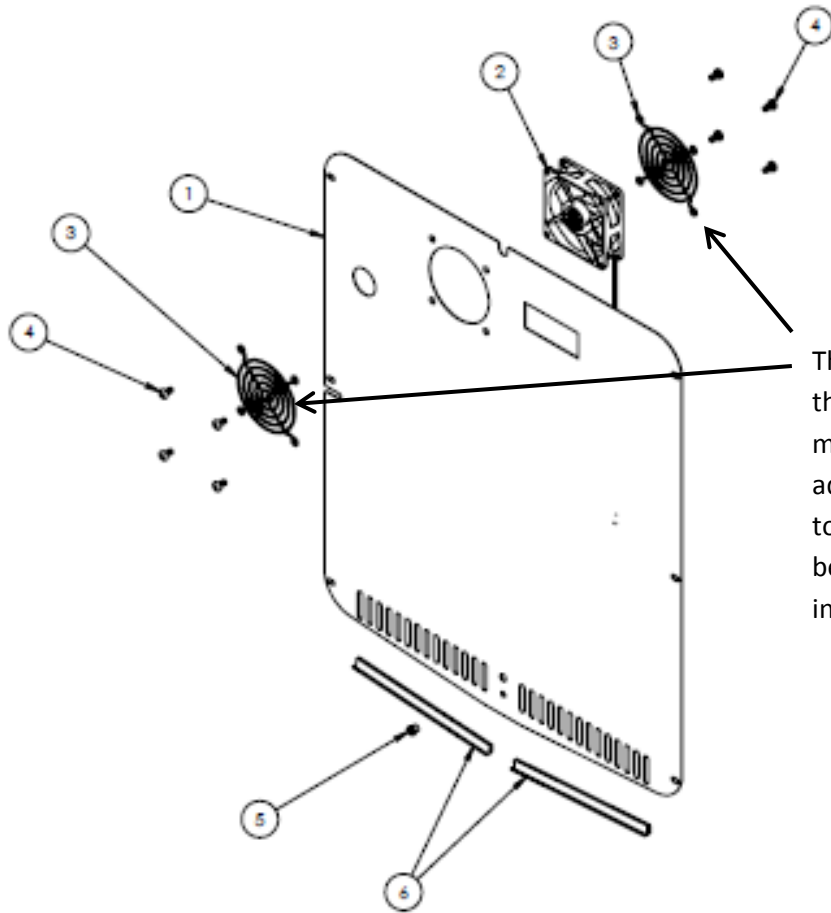

This exploded view drawing shows the front and rear fan guard. As mentioned on the previous page, the additional rear fan guard was added to outdoor beverage centers and beverage dispensers to prevent wire interference.

17.4: Thermistors

Thermistors are still NTC and located on the midway point of either the left or right hand side of the cabinet liner. A defrost thermistor is also attached to the upper left hand evaporator plate (Refer to Section 6).

Shielded Cabinet Air Thermistor

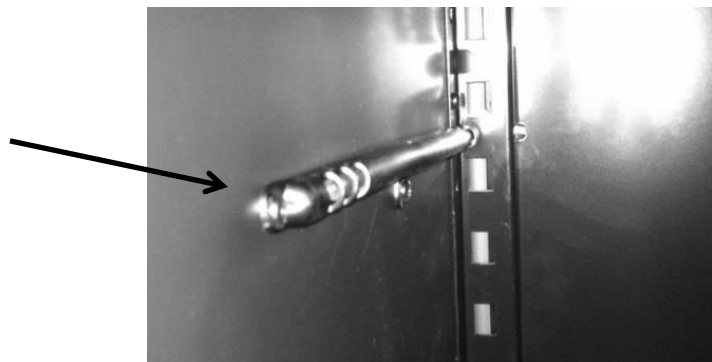

17.5: Control Type

The Prime control is used in all outdoor applications. It is the same basic control as the previously used Micro Sentry controls; however the control is reduced considerably in depth and appears identical to the control used in the previous door mounted versions in the Marvel Scientific models.

17.6 : Control Functions

The following is an excerpt from the customer Owners Guide regarding general control usage.

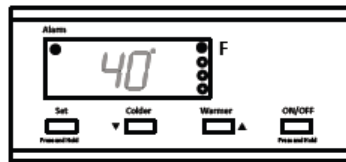

Figure 12
close-up of
control

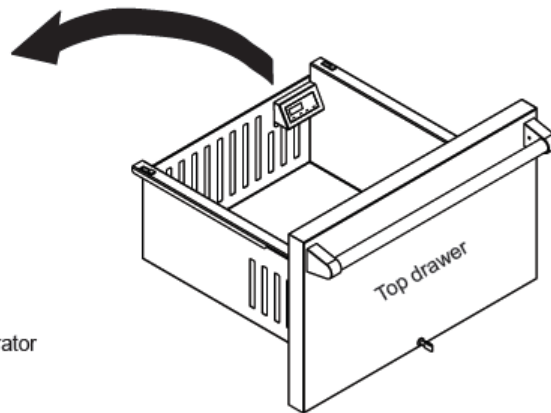

Figure 13

Starting your refrigerator

Plug the refrigerator power cord into a wall outlet. Your refrigerator will begin cooling after power is applied. If your refrigerator does not start, check that the refrigerator is turned on and the set temperature is cold enough.

Turning your refrigerator ON or OFF

If the refrigerator is on, the refrigerator temperature will be shown on the display. To turn the refrigerator off, press and hold the "ON/OFF" button for three (3) seconds. "OFF" will appear on the display.

If the refrigerator is not on, "OFF" will be shown on the display. To turn the refrigerator on, press and hold the "ON/OFF" button for three (3) seconds. The refrigerator temperature will be shown on the display.

Set temperature

To set the refrigerator temperature, press and hold the "SET" button. When the "SET" button is pressed, the display will show the set temperature. While holding the "SET" button, press the "WARMER" or "COLDER" buttons to adjust set temperature.

Refrigerator operation

The available temperature range of the refrigerator is 34° to 42°F (1° to 6° C).

It may take up to 24 hours for your refrigerator to reach desired temperature. This will depend on amount of content loaded and number of door opening and closings.

For best results allow refrigerator to "pull down" to desired set temperature before loading. Once contents are loaded, allow at least 48 hours for temperature to stabilize before making any adjustments to the set temperature.

Alarms

Your MARVEL Prime Controls™ will monitor refrigerator function and alert you with a series of audible and visual alarms.



- **Door Ajar Alarm:** If the door has been left open for over five (5) minutes, the alarm will sound in one (1) second intervals. The display panel will flash "do" and the Alarm LED located at the top left of the display below the word "Alarm" will be illuminated. This will stop as soon as the door is closed.



- **Temperature Sensor Fault:** If the controller detects that the temperature sensor is not properly functioning, a temperature sensor alarm will sound in one (1) second intervals. "E1" will flash on the display panel and the Alarm LED located at the top left of the display below the word "Alarm" will be illuminated. Please call AGA MARVEL Customer Service or your dealer if this error code is displayed.

Alarm Mute

Press any key to mute the audible portion of an alarm. NOTE-This action will only mute the alarm. If the condition that caused the alarm continues, the alarm code will continue to flash and will sound for 20 seconds every 60 minutes.

17.7: Control Locations per Model

17.7.1: Beverage Centers and Beverage Dispensers (6 cu. ft.)



17.7.2: Beverage Center (3 cu. ft.)



17.7.3: Refrigerator Drawer



Location: Upper Right Hand corner of the top drawer.

17.8: Machine Compartment

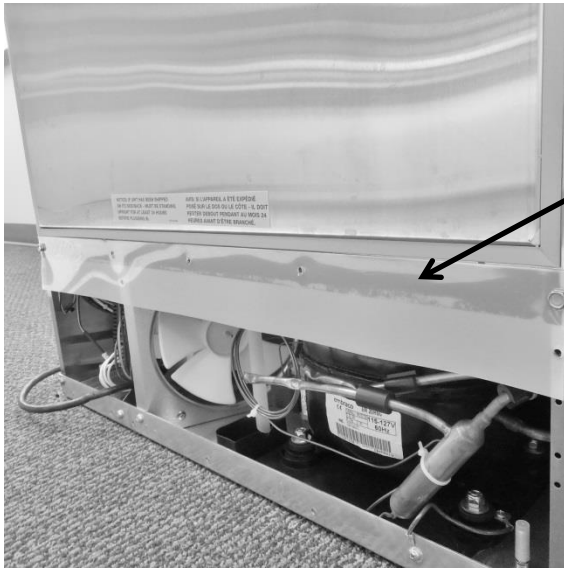

Mylar rain curtain on all outdoor under counter products.

The basic machine compartment and mechanical assembly is nearly identical as discussed in Section 3, seen earlier in this manual.

17.9: Main Power Board Access

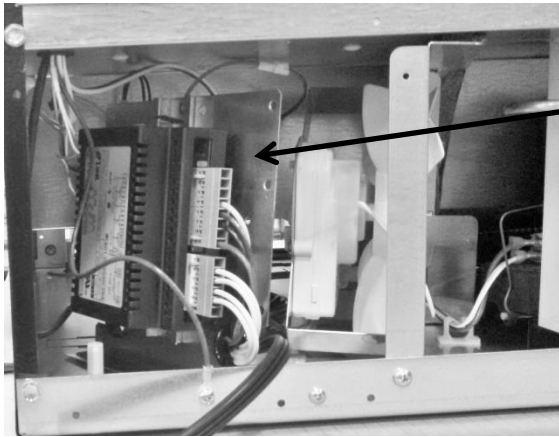

The main power board location is on the left hand side of the machine compartment.

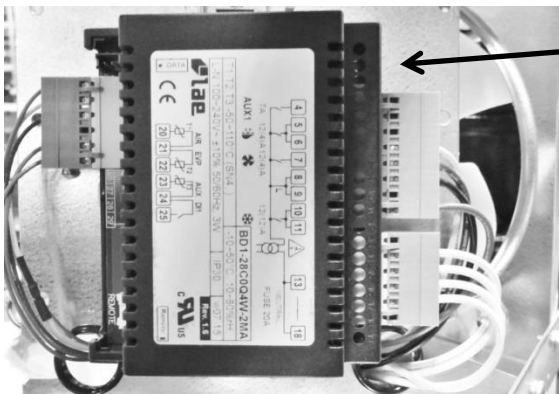

Visual of the main control board attached to its mounting bracket with all wire harnesses connected.



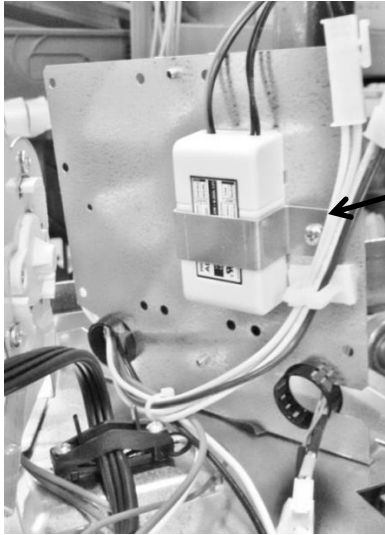

12 VDC Power Supply – *Serves the evaporator fan.* Located on rear side of the main power board bracket.

17.10: Display Access and Replacement

17.10.1: 3 Cubic Beverage Centers



To access the control, remove the two screws on the bottom housing flange. These screws also secure the fan grill and motor to the evaporator cover.



After removing the screws, grasp the control and pull away from the evaporator cover.

To disconnect, press the release tab on the side of the wire connector and remove the communication cable.



The control can be removed by depressing the four locking tabs (2 on each side) on the control body, with the end of a small screw driver.

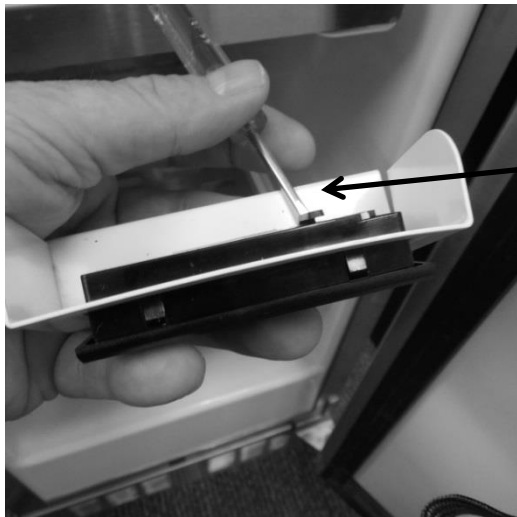

A small screw driver is used to release the locking tabs on the control from the control housing.



The control can now be removed through the front of the housing.

17.10.2: 6 Cubic Foot (Beverage Centers and Dispensers)



Tab release: Two tabs are located on the top and two on the bottom on the control.



To remove the control: Insert your fingers on the top of the control and press downward. This will release the two bottom tabs. Pull the top of the control outward from the evaporator cover.

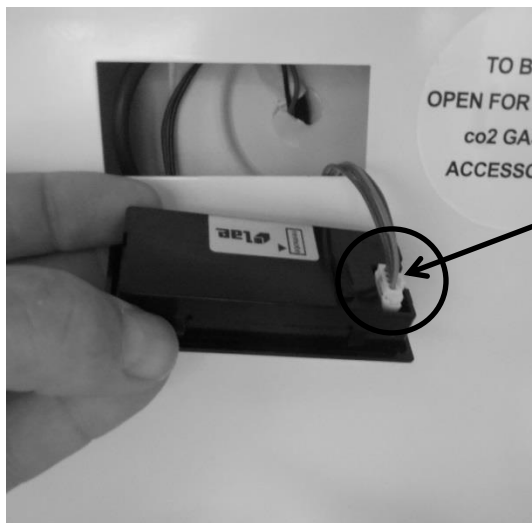

Disconnect the wire harness from the control by pressing the release tab on the outside of the connector.

Reverse the process above to re-install the control.

17.10.3: 6 Cubic Foot (Refrigerated Drawers)



On Refrigerated Drawers: Follow the steps below. Two mounting screws are located on the bottom flange of the control housing.

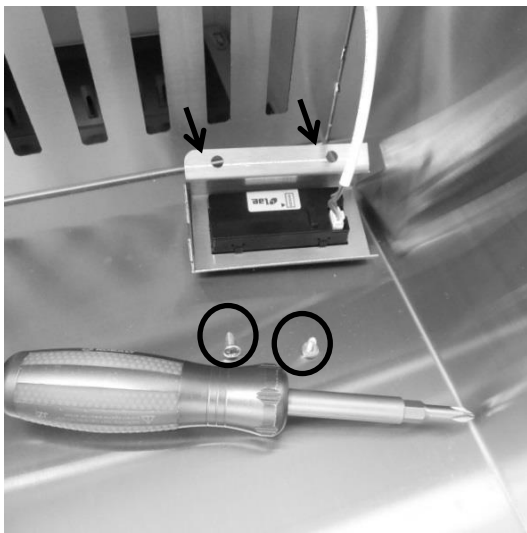

To access the control, remove the two screws on the bottom housing flange. Grasp the control and pull away from the drawer.

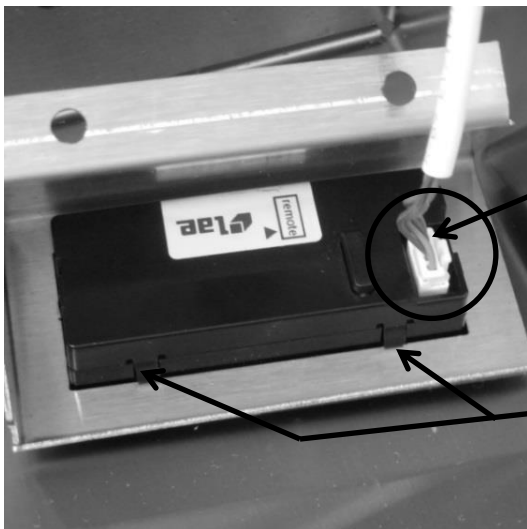

To disconnect, press the release tab on the side of the wire connector and remove the communication cable.

Locking tabs, push to release.

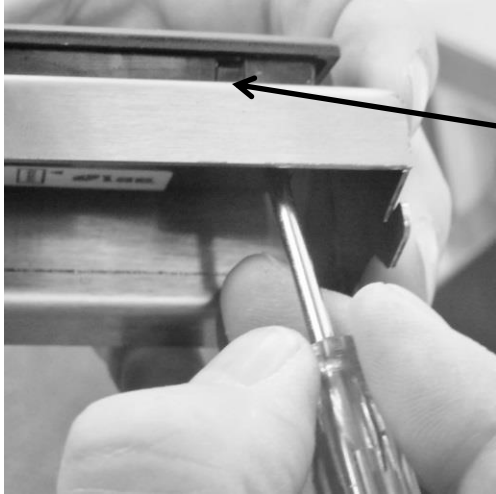

The control can be removed by depressing the four locking tabs (2 on each side) of the control body, with the end of a small screw driver. This will allow the control to be removed from the front of the housing.



Locking tabs, push to release.

17.11: Thermistor Resistance

- Temperatures are monitored individually by 10K @ 25°C NTC sensors.
- This is a reduced version of the resistance chart seen in Section 6.4

°C	°F	K- Ohms
-15	5	5.365
-10	14	4.251
-5	23	3.389
0	32	2.722
5	41	2.202
10	50	1.793
15	59	1.467
20	68	1.208
25	77	1
30	86	0.8315
35	95	0.6948
40	104	0.5834
45	113	0.4917

17.12: Wiring Diagram

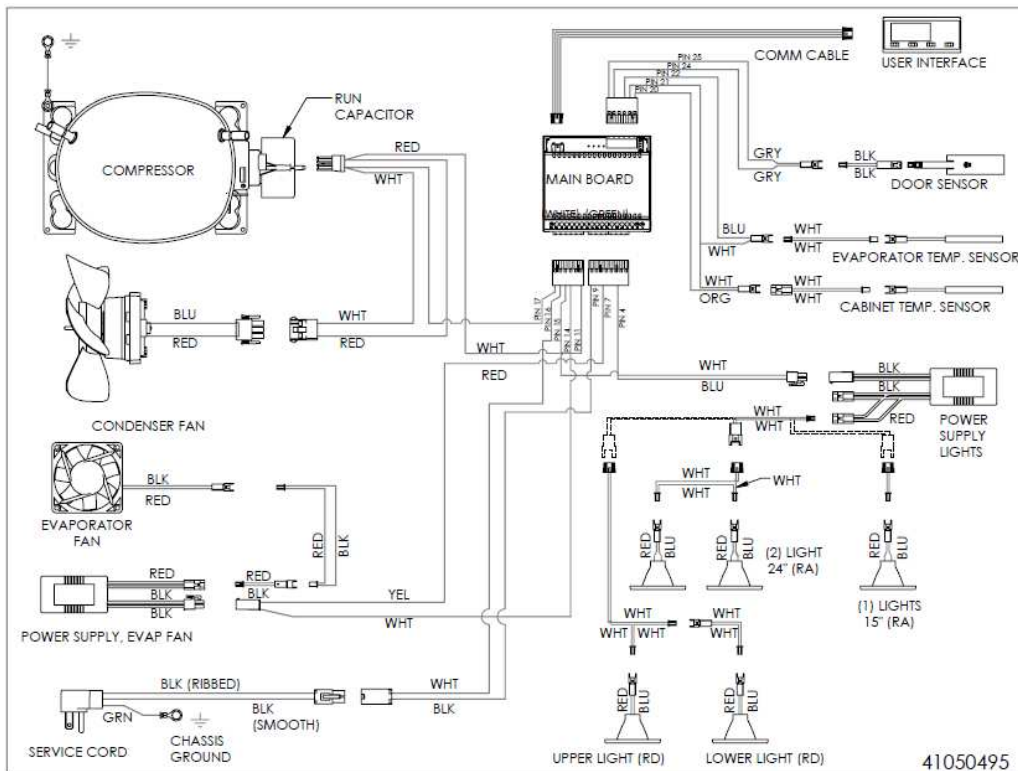

17.13: Generic Trouble shooting Charts

- The following charts are offered for reference only and are not comprehensive diagnostic charts.
- **NOTE:** Any page numbers referenced on these charts are referring to the Customers Owners Guide NOT this Service Manual.

17.13.1: Refrigerated Drawers

Problem	Possible Cause	Remedy
Appliance not cold enough (See "Adjusting the temperature" on page 10)	• Control set too warm	• Adjust temperature colder. Allow 24 hours for temperature to stabilize.
	• Content temperature not stabilized.	• Allow temperature to stabilize for at least 24 hours.
	• Excessive usage or prolonged drawer openings.	• Airflow must not be obstructed to front grille. See "clearances" on page 4.
	• Airflow to front grille blocked.	• Adjust or replace drawer gasket.
Appliance too cold (See "Adjusting the Temperature" on page 10)	• Drawer gasket not sealing properly.	• Adjust temperature warmer. Allow 24 hours for temperature to stabilize.
	• Control set too cold	• Adjust or replace drawer gasket.
No interior light.	• Failed LED light assembly or light switch.	• Contact a qualified service technician.
Light will not go out when drawer is closed	• Drawer not activating light switch.	• Appliance not level, level appliance, (See page 4, "leveling legs")
	• Failed light switch	• Contact a qualified service technician.
Noise or Vibration	• Appliance not level	• Level appliance, see "Leveling Legs" on page 4.
	• Fan hitting tube obstruction.	• Contact a qualified service technician.
Appliance will not run.	• Appliance turned off	• Turn appliance on. See "Starting your appliance" on page 10.
	• Power cord not plugged in.	• Plug in power cord.
	• No power at outlet.	• Check house circuit.

17.13.2: Beverage Centers

Problem	Possible Cause	Remedy
Appliance not cold enough (See "Adjusting the temperature" on page 10)	<ul style="list-style-type: none"> Control set too warm Content temperature not stabilized. 	<ul style="list-style-type: none"> Adjust temperature colder. Allow 24 hours for temperature to stabilize.
	<ul style="list-style-type: none"> Excessive usage or prolonged door openings. 	<ul style="list-style-type: none"> Allow temperature to stabilize for at least 24 hours.
	<ul style="list-style-type: none"> Airflow to front grille blocked. 	<ul style="list-style-type: none"> Airflow must not be obstructed to front grille. See "clearances" on page 4.
	<ul style="list-style-type: none"> Door gasket not sealing properly. 	<ul style="list-style-type: none"> Check door alignment and/or replace door gasket.
Appliance too cold (See "Adjusting the Temperature" on page 10)	<ul style="list-style-type: none"> Control set too cold 	<ul style="list-style-type: none"> Adjust temperature warmer. Allow 24 hours for temperature to stabilize.
	<ul style="list-style-type: none"> Door gasket not sealing properly. 	<ul style="list-style-type: none"> Check door alignment and/or replace door gasket.
No interior light.	<ul style="list-style-type: none"> Failed LED light assembly or light switch. 	<ul style="list-style-type: none"> Contact a qualified service technician.
Light will not go out when door is closed	<ul style="list-style-type: none"> Display light is turned on. (Glass door models only.) 	<ul style="list-style-type: none"> Turn off display light, shut door.
	<ul style="list-style-type: none"> Door not activating light switch. 	<ul style="list-style-type: none"> Appliance not level, level appliance, (See page 4, "leveling legs") Verify the door is aligned properly, refer to page 17 for instructions.
	<ul style="list-style-type: none"> Failed light switch 	<ul style="list-style-type: none"> Contact a qualified service technician.
Noise or Vibration	<ul style="list-style-type: none"> Appliance not level 	<ul style="list-style-type: none"> Level appliance, see "Leveling Legs" on page 4.
	<ul style="list-style-type: none"> Fan hitting tube obstruction. 	<ul style="list-style-type: none"> Contact a qualified service technician.
Appliance will not run.	<ul style="list-style-type: none"> Appliance turned off 	<ul style="list-style-type: none"> Turn appliance on. See "Starting your appliance" on page 10.
	<ul style="list-style-type: none"> Power cord not plugged in. 	<ul style="list-style-type: none"> Plug in power cord.
	<ul style="list-style-type: none"> No power at outlet. 	<ul style="list-style-type: none"> Check house circuit.

17.14: Refrigeration and Mechanical

The basic refrigeration and mechanical operation and assembly are not unlike that discussed earlier in this manual. This information can be reviewed in Chapters 3 and 4.

The basic machine compartment and mechanical layout is nearly identical as discussed in Section 3 seen earlier in this manual.

Section 18: Prime Control

18.1: Control Type

The prime control still utilizes the top mounted control housing as seen in the picture below. It is the same basic control as the previously used Micro Sentry controls; however the control is reduced considerably in depth and appears identical to the control used in the previous door mounted versions in the Marvel Scientific models and the current *Outdoor Models*.

The control system is driven by a NTC thermistor, located on the mid cabinet sidewall and defrosted by a similar thermistor attached to the upper left hand evaporator plate (Refer to section 6).

The control housing assembly consists of the control, display light button, and the door activated light rocker switch.

Excluding model options, the cabinet design, mechanical operation, and air flow are identical to that mentioned in section 3 of this manual. The main difference seen between the Prime and Aurora control systems is that of the control system itself. There is no variation cabinet and defrost thermistor function between the two control model types.



Light Rocker Switch – Door activated



Access the control housing by loosening the two recessed screws in the front edge of the housing and one screw in the rear flange of the housing. Slide the housing forward and let it carefully drop away.



Rocker Switch Closer

18.2: Control Functions

The following is an excerpt from the customer Owners Guide regarding general control usage.

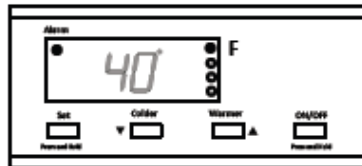

Figure 13
close-up of
control

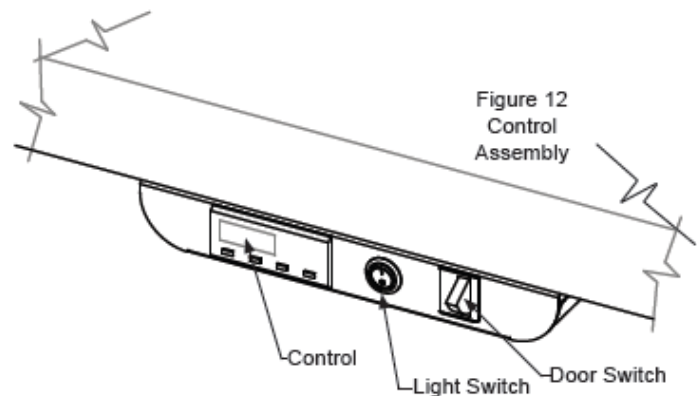

Figure 12
Control
Assembly

Starting your beverage center

Plug the beverage center power cord into a wall outlet. Your beverage center will begin cooling after power is applied. If your beverage center does not start, check that the beverage center is turned on and the set temperature is cold enough.

Turning your beverage center ON or OFF

If the beverage center is on, the beverage center temperature will be shown on the display. To turn the beverage center off, press and hold the "ON/OFF" button for three (3) seconds. "OFF" will appear on the display.

If the beverage center is not on, "OFF" will be shown on the display. To turn the beverage center on, press and hold the "ON/OFF" button for three (3) seconds. The beverage center temperature will be shown on the display.

Set temperature

To set the beverage center temperature, press and hold the "SET" button. When the "SET" button is pressed, the display will show the set temperature. While holding the "SET" button, press the "WARMER" or "COLDER" buttons to adjust set temperature.

Beverage center operation

The available temperature range of the beverage center is 34° to 42°F (1° to 6° C).

It may take up to 24 hours for your beverage center to reach desired temperature. This will depend on amount of content loaded and number of door opening and closings.

For best results allow beverage center to "pull down" to desired set temperature before loading. Once contents are loaded, allow at least 48 hours for temperature to stabilize before making any adjustments to the set temperature.

Alarms

Your MARVEL Prime Controls™ will monitor beverage center function and alert you with a series of audible and visual alarms.



- **Door Ajar Alarm:** If the door has been left open for over five (5) minutes, the alarm will sound in one (1) second intervals. The display panel will flash "do" and the Alarm LED located at the top left of the display below the word "Alarm" will be illuminated. This will stop as soon as the door is closed.



- **Temperature Sensor Fault:** If the controller detects that the temperature sensor is not properly functioning, a temperature sensor alarm will sound in one (1) second intervals. "E1" will flash on the display panel and the Alarm LED located at the top left of the display below the word "Alarm" will be illuminated. Please call AGA MARVEL Customer Service or your dealer if this error code is displayed.

Alarm Mute

Press any key to mute the audible portion of an alarm. NOTE-This action will only mute the alarm. If the condition that caused the alarm continues, the alarm code will continue to flash and will sound for 20 seconds every 60 minutes.

18.3: Fans

Fan function and location is not unlike the indoor Marvel and Marvel Pro models. Air is drawn across the evaporator plate from the supply louvers and outward into the interior cabinet through the circulation fan. The blades rotate in a clockwise direction as you face the hub.



18.4: Thermistors

Thermistors are still NTC and located on the midway point of either the left or right hand side of the cabinet liner. A defrost thermistor is also attached to the upper left hand evaporator plate (Refer to section 6).



Shielded Cabinet
Air Thermistor

18.5: Machine Compartment

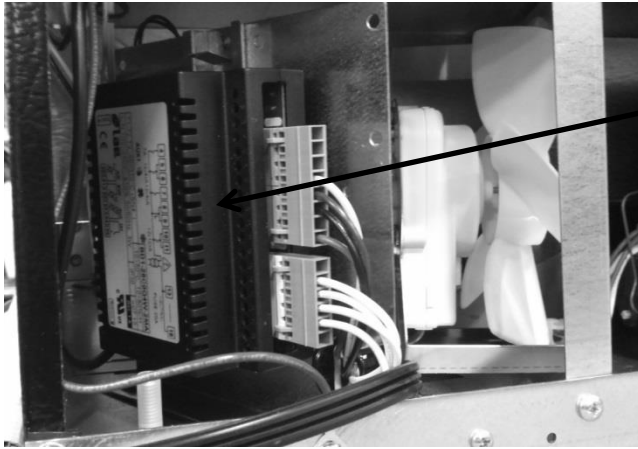

Main Power Board – Located in the left hand side of machine compartment.

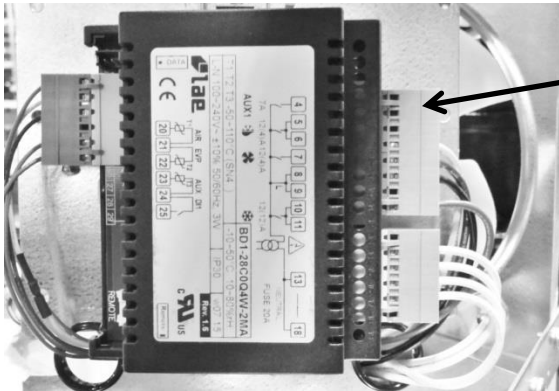

Visual of the main control board attached to its mounting bracket with all wire harnesses connected.

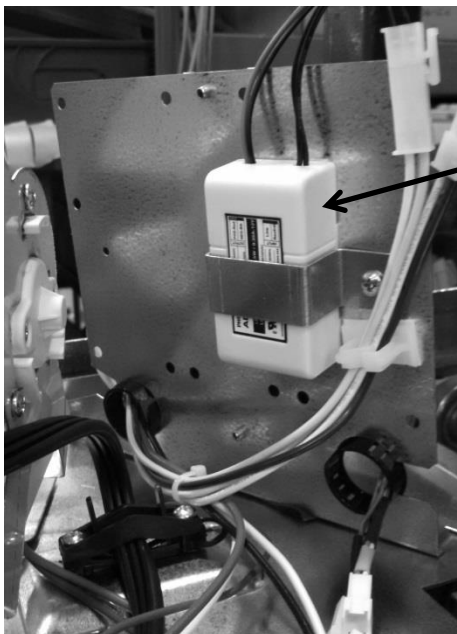

12 VDC Power Supply – Serves the *evaporator fan*. The power supply is located on the rear side of the main power board bracket.

18.6: Thermistor Resistance

- Temperatures are monitored individually by 10K @ 25°C NTC sensors.
- This is a reduced version of the resistance chart seen in Section 6.4.

°C	°F	K- Ohms
-15	5	5.365
-10	14	4.251
-5	23	3.389
0	32	2.722
5	41	2.202
10	50	1.793
15	59	1.467
20	68	1.208
25	77	1
30	86	0.8315
35	95	0.6948
40	104	0.5834
45	113	0.4917

18.7: Wiring Diagram

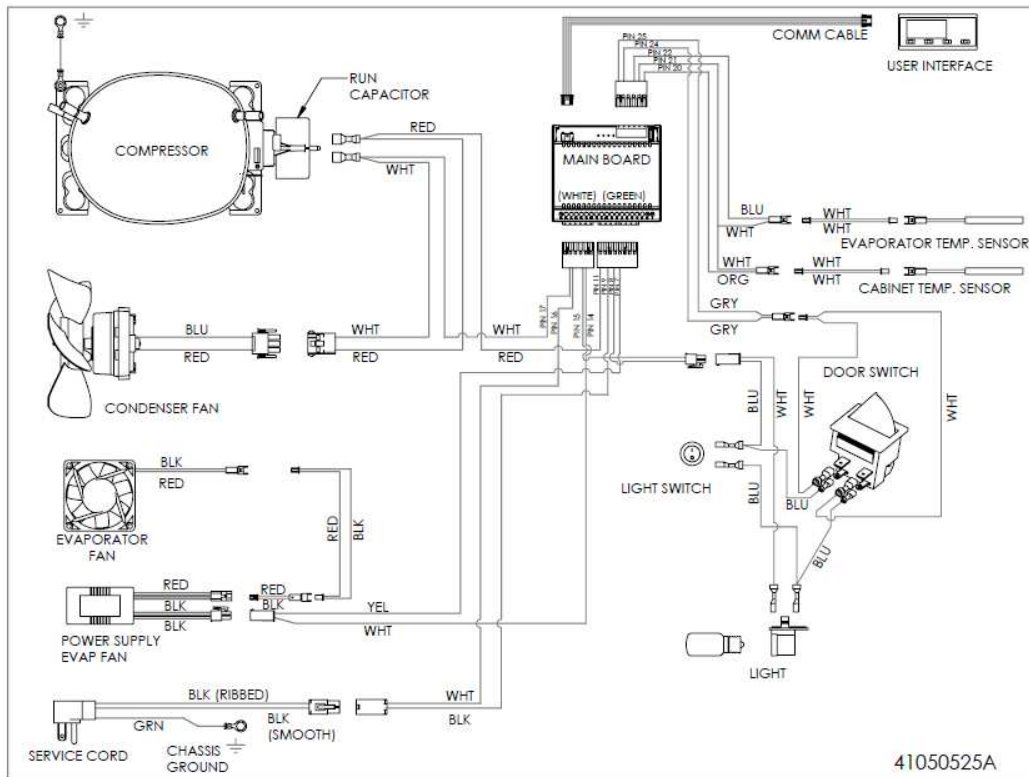

18.8: Generic Trouble shooting Chart

- The following charts are offered for reference only and are not comprehensive diagnostic charts.
- **NOTE:** Any page numbers referenced on these charts are referring to the Customers Owners Guide NOT this Service Manual.

Problem	Possible Cause	Remedy
Appliance not cold enough (See "Set temperature" on page 10)	• Control set too warm	• Adjust temperature colder. Allow 24 hours for temperature to stabilize.
	• Content temperature not stabilized.	• Allow temperature to stabilize for at least 24 hours.
	• Excessive usage or prolonged door openings.	• Airflow must not be obstructed to front grille. See "clearances" on page 4.
	• Airflow to front grille blocked.	• Check door alignment and/or replace door gasket.
Appliance too cold (See "Set temperature" on page 10)	• Door gasket not sealing properly.	• Adjust temperature warmer. Allow 24 hours for temperature to stabilize.
	• Control set too cold	• Check door alignment and/or replace door gasket.
No interior light.	• Light bulb is burned out	• Replace light bulb, see page 12.
Light will not go out when door is closed	• Display light is turned on. (Glass door models only).	• Turn off display light, shut door.
	• Door not activating light switch.	• Appliance not level, level appliance, (See page 4, "leveling legs")
	• Failed light switch	• Verify the door is aligned properly, refer to page 13 for instructions. • Contact a qualified service technician.
Noise or Vibration	• Appliance not level	• Level appliance, see "Leveling Legs" on page 4.
	• Fan hitting tube obstruction.	• Contact a qualified service technician.
Appliance will not run.	• Appliance turned off	• Turn appliance on. See "Starting your beverage center" on page 10.
	• Power cord not plugged in.	• Plug in power cord.
	• No power at outlet.	• Check house circuit.

18.9: Refrigeration and Mechanical

The basic refrigeration and mechanical operation and assembly are not unlike that discussed earlier in this manual. This information can be reviewed in Chapters 3 and 4.

The basic machine compartment and mechanical assembly is nearly identical as discussed in Section 3, seen earlier in this manual.

Section 19: Clear Ice Machines

19.1 Control Operation:

USING YOUR ELECTRONIC CONTROL



Figure 19
User interface display

Display icons:



"ON/OFF" icon : used for turning the appliance on and off.



"MENU" icon : used to access optional functions in the user interface.



"Clock" icon : used to enter the Delay start/vacation mode.



"LOCK" icon : used to lock out functions in the user interface.

NOTE

The control display is covered with a clear plastic film. This film may be removed by carefully lifting at a corner.

Starting your clear ice machine:

Plug the ice machine into a 115 volt wall outlet, (see page 5 for electrical information). Your appliance is shipped from the factory in the "ICE" mode and will begin start-up of ice production. If the appliance does not start, confirm the wall outlet has power, and the control is in the "ICE" mode, (see options section below). Do not start the ice machine in "ECO" mode. "ECO" mode should only be used after there is a full bin of ice.

ICE

Display area text:

ICE

Signifies the appliance is on and producing ice.

ECO

Signifies the appliance is in economical ice production mode.

OFF

Signifies the appliance is off

DOOR

Signifies a door ajar alarm condition.

CLEAN

Cleaning is recommended or the appliance is in the clean mode.



Signifies the appliance is in Sabbath mode



CAUTION

Turning the ice machine "OFF" will only terminate the ice production, it does not remove power from the appliance. Always unplug the power cord from the wall outlet before servicing the unit.

Delay start/Vacation mode:



hours
days

1

4

6

8

Hours or days timer is set for

Hours or days will be lit

When lit, this signifies the delay start/vacation mode is operational.

Turning your ice machine On and Off:

If your appliance is on, "ICE" will be displayed. To turn the appliance off, push and hold the "ON/OFF" icon for 3-seconds. The display will show "OFF". The drain pump (if equipped) and the interior light will still be functioning during the OFF mode. To turn the appliance back on, press and hold the "ON/OFF" icon for 3-seconds, the display will show "ICE". If the appliance is in Sabbath mode as indicated by the "Sabbath icon" on the display, Sabbath mode must be exited to enable the "ON/OFF" function, (see Sabbath section below).

ICE



OFF



ICE

USING YOUR ELECTRONIC CONTROL

Control Lock:

The user interface can be locked to avoid unintentional changes from things like cleaning. To lock the appliance, push and hold the "LOCK" icon for 5-seconds. The "LOCK" icon will flash 3 times, then change to steady back-lit. To unlock the user interface, press and hold the "LOCK" icon for 5-seconds, and the back-light will turn off.



NOTE

The "LOCK" icon is the only active key in this mode. If other icons are pressed while in the lock mode the "LOCK" icon will flash 3 times, and an audible tone will sound, to remind the user the appliance is in the lock mode.

Delay start/Vacation mode:

Your ice machine is equipped with a delay start function. This feature can be used to temporarily shut the appliance off for 1, 4, 6, or 8 hours or days. Upon completion of the selected delay period, the appliance will resume operation. This is ideal for temporarily stopping ice machine noises or to save water and electricity if you are away from home but want fresh ice upon your return.

To enter the delay start mode, press the "CLOCK" icon while the appliance is in "ICE" mode. This will delay the next harvest by the time displayed. Each additional press of the "CLOCK" icon will add time, from 1, 4, 6, or 8 hours, to 1, 4, 6, or 8 days. The next press after 8 days will leave delay set mode. After the desired time has been determined, press the "ON/OFF" icon for 2 seconds to accept, your unit will shut off and a clock icon and your selected time will be displayed. When the selected time has elapsed, normal ice production will resume.



To cancel the delayed start, press and hold the "ON/OFF" icon until the appliance enters OFF, then press and hold the "ON/OFF" icon again until the appliance enters "ICE" mode.



OFF



ICE

Clean reminder:

A "CLEAN" reminder will occur every 6 months to remind you that it may be time to clean your appliance. Over time mineral build up on the cold evaporator plate can occur which can adversely affect the quality of your ice. This build-up is dependent on your water source. Normal ice production will continue while the "CLEAN" reminder is displayed. You may clear the "CLEAN" reminder at any time by momentarily pressing the "ON/OFF" icon. When reset, the "CLEAN" reminder will reset and not occur for another 6 months. If you choose to clean the appliance at this time, see the options menu section below.

CLEAN



Door ajar alarm:

If the door is open, or not closed properly for 5 minutes the "DOOR" indicator will illuminate and flash and an audible tone will sound. This alarm condition can be reset by closing the door or momentarily pressing the "ON/OFF" icon, (i.e.-if you are cleaning the storage compartment, etc.). The alarm will recur in 5 minutes if the alarm condition persists.

DOOR



If the door is intentionally left open for long periods, the alarm can be disabled by turning the unit off.

Options menu:



Normal and ECO mode:

Your ice machine comes with an optional "ECO" mode. While in this mode ice production will slow and the appliance will use less water and electricity. "ECO" mode should only be used after there is a full bin of ice. To enter "ECO" mode do the following:

ECO

- Press the "MENU" icon twice and the green "ECO" will flash.
- Press and hold the "ON/OFF" icon until the green "ECO" stops flashing and remains illuminated.
- To return to the standard operating rate press the "MENU" icon twice, the ECO will turn off and the "ICE" will be flashing. Press and hold the "ON/OFF" icon until the "ICE" stops flashing and remains illuminated.



ICE

USING YOUR ELECTRONIC CONTROL

Clean mode:

To clean your ice machine you will need to purchase a "nickel safe" ice maker cleaner. Cleaner can be obtained by contacting AGA Marvel customer service at 800-223-3900 or are available at most appliance retailers or through the cleaners website. Several recommended cleaners are listed below:

- Kirby's Certified ice machine cleaner. 100% nickel safe.
- Nu-Calgon nickel safe ice machine cleaner.
- Franklin Machine Products Nickel safe ice machine cleaner.



Once you have your cleaner:

Turn the ice machine off by pressing and holding the "ON/OFF" icon for 3 seconds. "OFF" will be displayed on the control.

OFF

Remove the grid cutter cover (see Figure 22) by pulling the cover off of the three rubber isolation mounts.

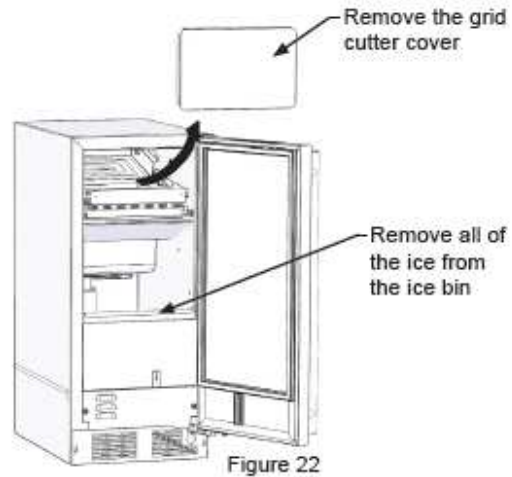

Figure 22

Remove all ice from the ice bin, (see Figure 22). Drain the water from the water reservoir, by removing the black plug from the bottom of the fresh water reservoir. (See Figure 23). After the water is drained replace the plug in the bottom of the reservoir.

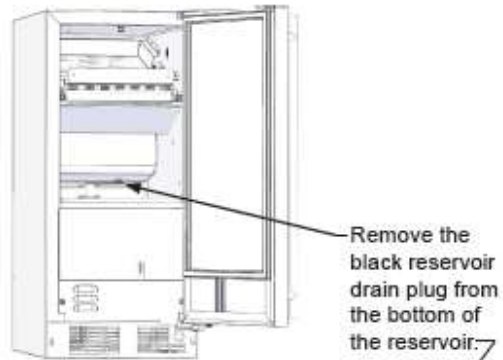

Figure 23

Allow all of the ice to fall from the evaporator plate and remove any ice from the grid cutter. If there is ice embedded in the grid cutter wires, wait for it to melt and fall out. Do not try to remove ice that is embedded in the grid cutter wires as that may break the wires. (See Figures 20 and 21).



CAUTION

Forcing ice through the grid cutter will break the grid cutter wires.

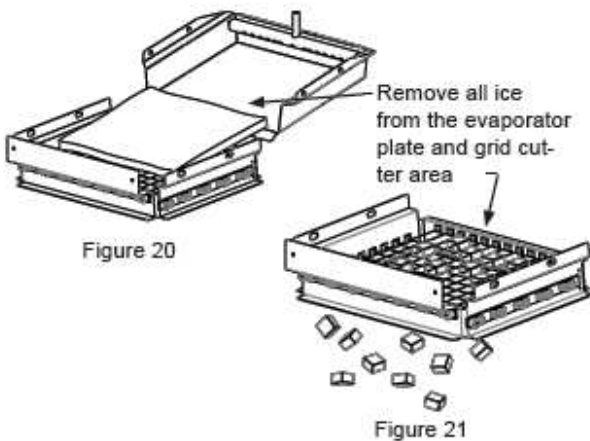

Figure 20

Figure 21

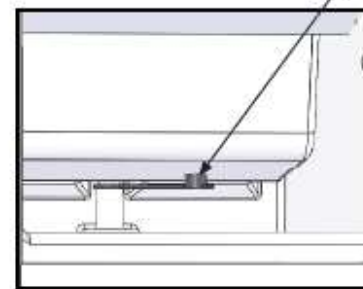

Figure 23b

USING YOUR ELECTRONIC CONTROL

Refer to your cleaning solution to determine the proper amount of cleaning solution to add based on 3 quarts (2.8 liters) of water. Pour the cleaning solution between the evaporator plate and the grid cutter so it flows down into the fresh water reservoir. (See Figure 25). The plastic splash shield can be removed to improve access. (See Figure 24).

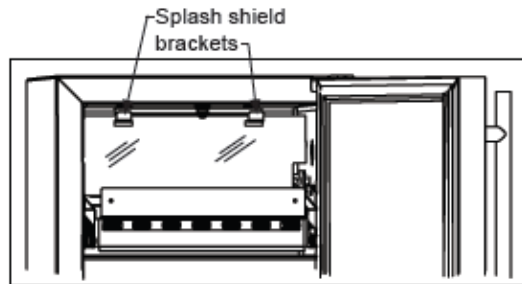

Figure 24

Turn the ice machine back on by pressing and holding the "ON/OFF" icon for 3 seconds. The display will indicate "ICE" mode. Press and hold the "MENU" icon until a flashing "CLEAN" is displayed. Press the "ON/OFF" icon until "CLEAN" stops flashing. Your ice machine will now enter the clean cycle.



ICE



CLEAN

OFF

The clean and rinse cycle will take about 49 minutes.

After the clean cycle is complete the ice machine will return to the "OFF" position.

After the cleaning cycle is completed, verify that all build-up has been removed. If not repeat the clean cycle procedure.

Optional: After the cleaning cycle has been completed, you may wash the interior with a mild detergent / dish soap or a solution of two tablespoons of baking soda and one quart of water. Rinse with clean water.

Replace the grid cutter cover.

Your ice machine is now ready to restart. Press and hold the "ON/OFF" icon for 3 seconds until "ICE" is displayed.



ICE

NOTE

After cleaning it is recommended you discard the ice after 3 hours of ice production.

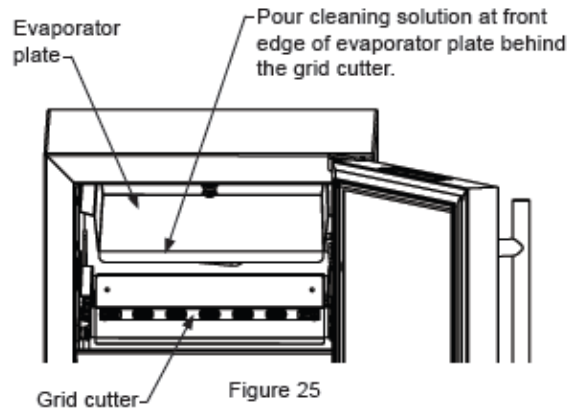

Figure 25

Sabbath mode:

Your ice machine comes with a Sabbath mode, which can be used as required to observe the religious holiday within the Orthodox Jewish Community. While in Sabbath mode the appliance will continue to operate, but no events or changes in state will occur as a result of direct human interaction. You can open or close the door to access the ice without concern of directly turning on or off any light, digital readings, solenoids, valves, compressor, tones or alarms.

When activated, the display, alarm indicators, keypad touch tones, interior lights and all options are disabled. All keypad functions are disabled, with the exception of the "ON/OFF" icon which can be used to exit the Sabbath mode function.



To enter Sabbath mode:

- Press and hold the "MENU" icon until the "CLEAN" text appears.
- Momentarily press the "MENU" icon again and the Sabbath indicator will appear and flash.
- Press and hold the "ON/OFF" icon until the Sabbath indicator stops flashing and remains illuminated.
- To exit the Sabbath mode, press and hold the "ON/OFF" icon until "ICE" is shown on the display.



CLEAN



ICE

19.2: Control System

19.2.1 The User Interface:

The User Interface display is mounted to the door top and connected to the main power board by means of a communication cable. The cable extends through the door and exits at the bottom hinge location.



19.2.1.1 Removing the User Interface Display

CAUTION

It is recommended that a grounding strap be used when working with any solid state control board application.

CAUTION

Care must be taken as a damaged wire or connector downstream from the display disconnect connector cannot be repaired or replaced. The display receiver and wiring harness are foamed in place. Any damage will result in a door replacement.

1. Use the bottom edge of both thumb nails to gently pry up on the left hand side of the display. **(DO NOT use a sharp object such as a jack knife, putty knife, or screwdriver. Objects like these can destroy the appearance of the display or scratch the door).**
2. Once the display is unseated, turn over and locate the display connector.
3. Using your thumb or forefinger to unsnap the lock.
4. Separate the connector and set the display aside.



Place finger nails under left hand lip of user interface display.



Lift upwards.

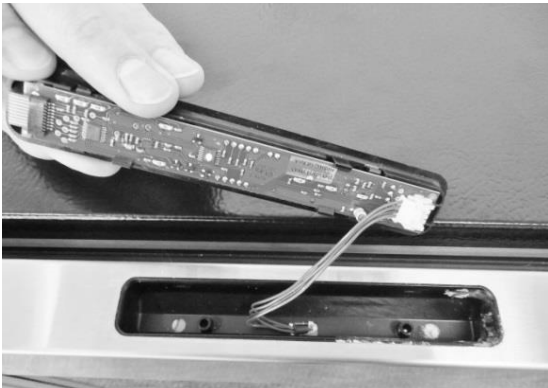

Lift user interface away from door receiver.



Release locking tab on display connector.



The user interface can now be removed.

User Interface PCA	
Terminal	Description
J1	Com Cable to Main Board
J2	ICON / Key Switch

19.2.1.2 Installing a new User Interface Display

1. Reverse the process used to remove the display board.
2. Carefully place the display back into the door receiver.
Apply a light downward pressure to the edge of the display to snap into place.

EXPLODED VIEW of User Interface Assembly

ICON/Key Switch Assembly



UI Carrier

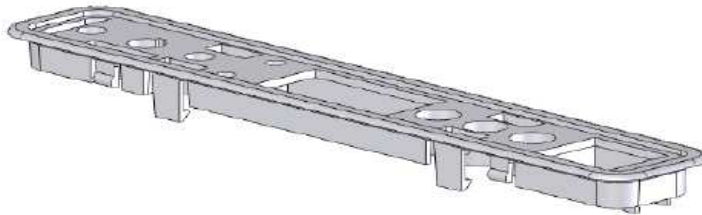

UI PCA

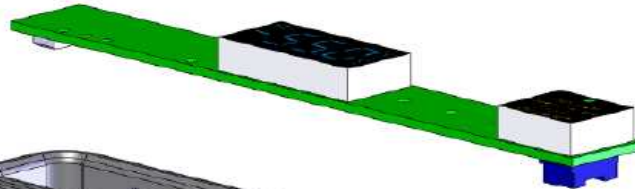

UI Receiver (foamed in)

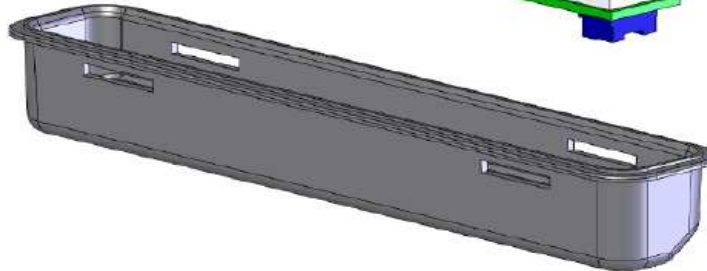

19.2.2 Main Control Board:

 **WARNING**

Prior to removing the access cover to the machine compartment, disconnect the supply voltage to the appliance. Failure to do this could result in an electrical shock or possible death.

 **CAUTION**

It is recommended that a grounding strap be used when working with any solid state control board application.

19.2.2.1 Control Board Replacement

1. The main power board is located at the bottom, right hand, front corner of the machine compartment.
2. To access the board, remove both the toe grill and access panel on the front of the machine. To remove the access panel, the door should also be removed for convenience.
3. The mullion bar separating the toe grill and the access panel should also be removed for convenience.
4. Remove the 5/16" sheet metal screw that secures the control board in place.
5. Remove both large connectors on the bottom left hand side of the control board. Press the release and pull each connector off its terminal.
6. The board can now be rotated into position to disconnect the remaining electrical connectors from the power board.
7. Once all wires are disconnected the board can then be maneuvered out of the appliance.
8. The main board mounting bracket and the control housing are manufactured for a positive fit upon installation.
 - a. The rear of the control bracket has two tabs to ensure a positive mounting position.
 - b. The rear of the control housing has two accommodating slots to accept the mounting tabs on the control board bracket.
 - c. Once the board is in position, it can be secured using the 5/16" sheet metal screw.
9. Each wiring harness at the board is labeled as to its corresponding location on the board. Prior to removing any harness, double check to insure that the identification on each harness is legible for correct placement when repair is completed.
10. The control board terminals are also marked as to the correct harness locations.

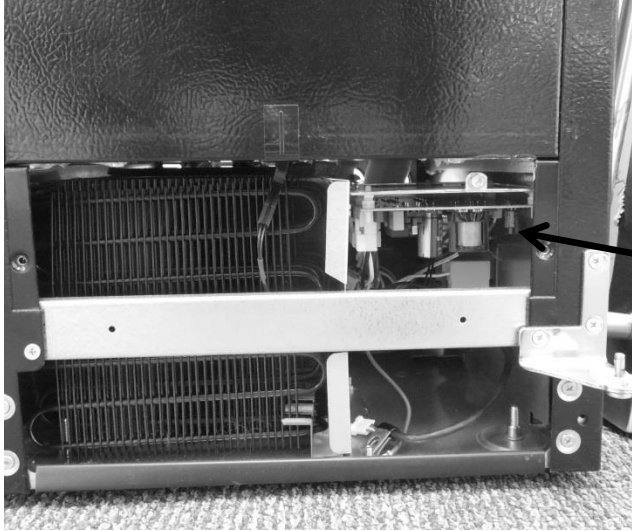

Location of the main power board.

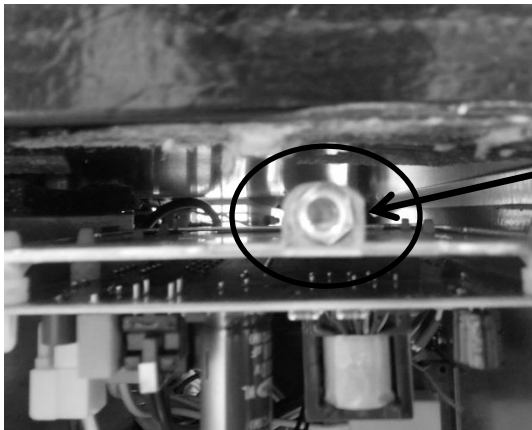

Remove screw holding the control board bracket in place.



Center mullion restricts ease of main power board access.

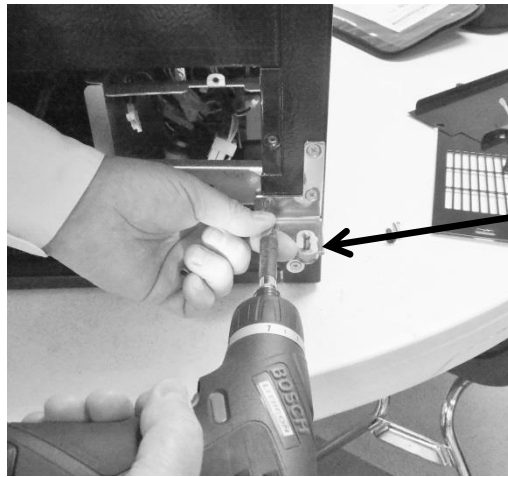

Remove bottom left hand screw from lower hinge.

Remove single screw on opposite end of mullion.

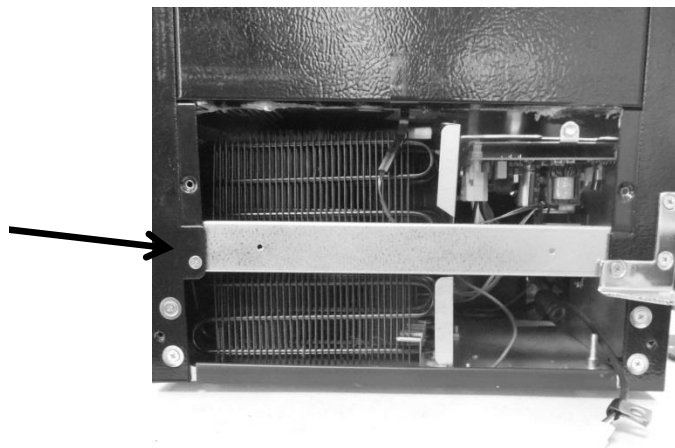

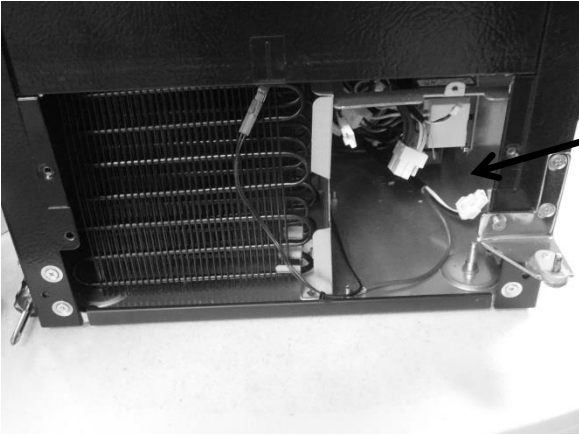

Mullion bar removed from the cabinet.

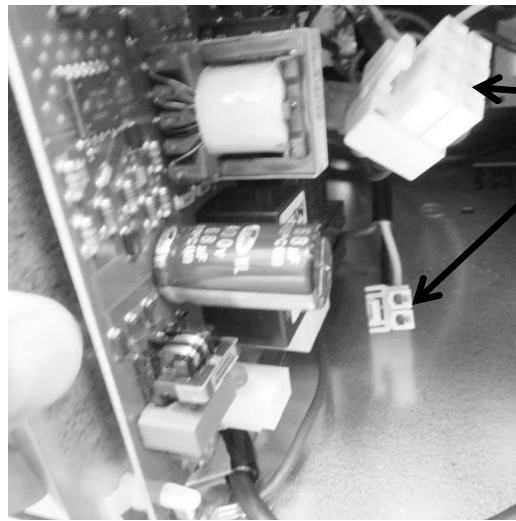

Tip board at a 90° angle and disconnect the two large white connectors from the power board.

Rotate the board as needed to disconnect the remaining cables from the control board. All disconnects have a quick release tab on the connector.

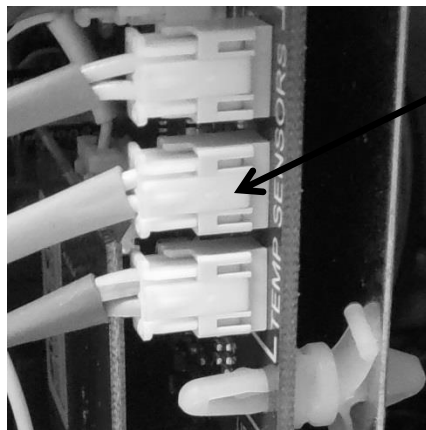

Example: Clip release on side of terminal disconnects. Press to release. A click will be heard when disengaged from control board.

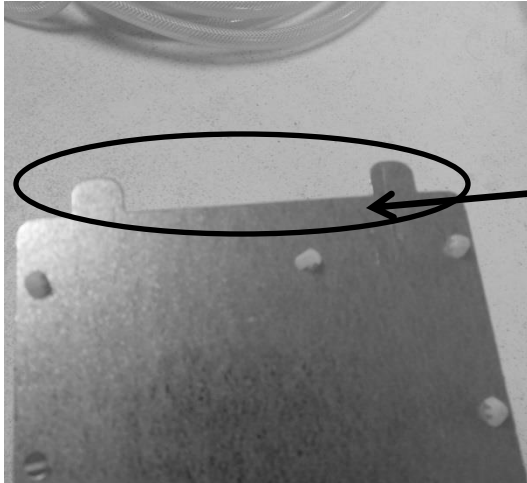

These two photos show both the mounting tabs on the bottom of the main control board bracket and the positioning slots on the adjoining mounting bracket inside the machine compartment.

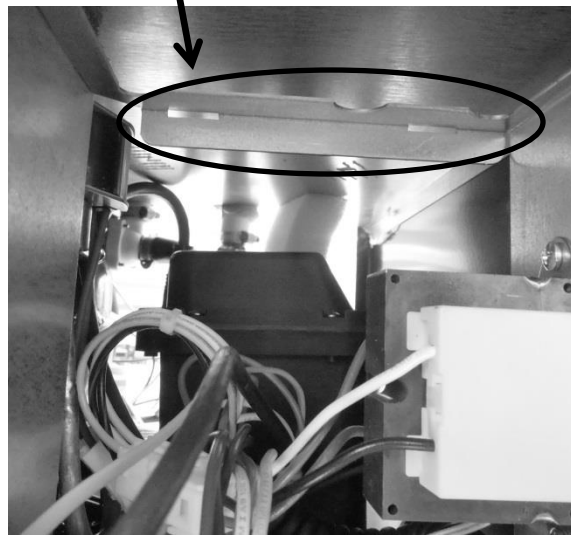

19.2.2.3 Control Board Terminal Identification

NOTE: For wiring diagram and schematic, please refer to section 19.8.

The following pictures represent terminal identification on a single zone main power board.

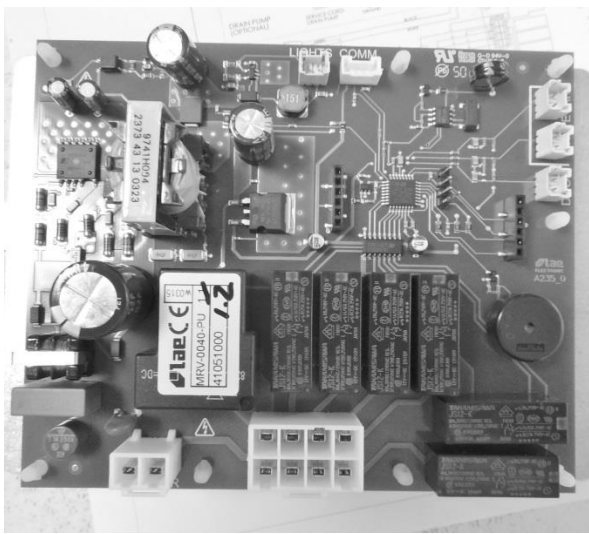

View of main power board. See wiring diagram and schematic included in this section.

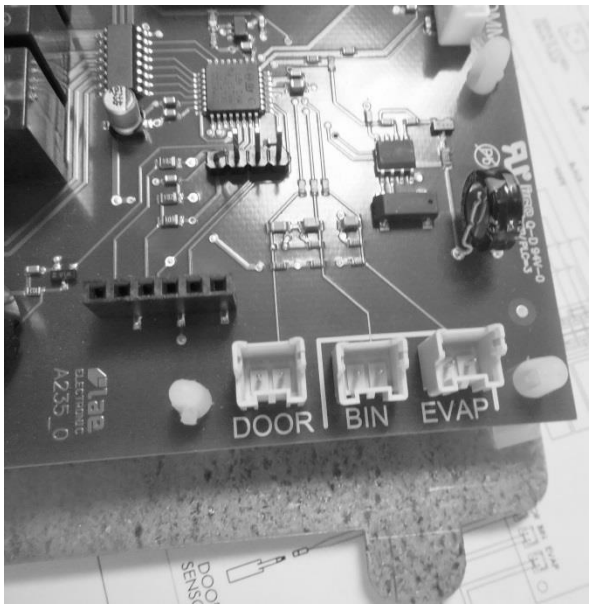

Connectors J3 – J5 (right to left): See wiring diagram and schematic included in this section.

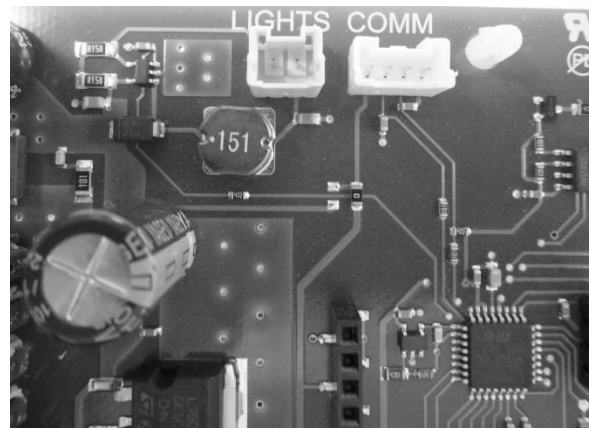

Connectors J6 & J7: (left to right): See wiring diagram and schematic included in this section.

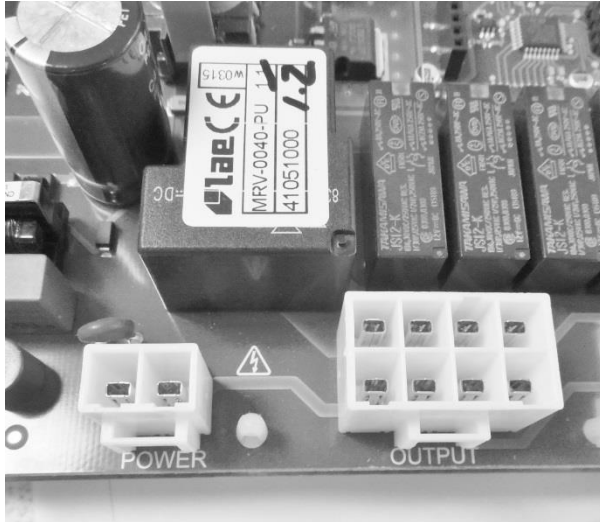

Connectors J1 and J7: See wiring diagram and schematic included in section 19.8.

EXPLODED VIEW: Of the control housing assembly.

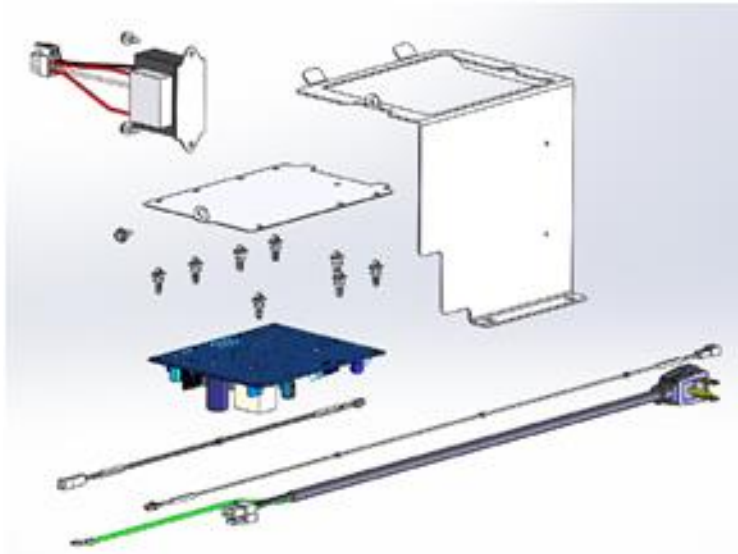

19.2.2.4 Control Board Installation

1. The main board mounting bracket and the control housing are manufactured for a positive fit upon installation.
 - a. The rear of the control bracket has two tabs to ensure a positive mounting position.
 - b. The rear of the control housing has two accommodating slots to accept the mounting tabs on the control board bracket.
 - c. Once the board is in position, it can be secured using the 5/16" sheet metal screw.

2. Replace all previously removed wiring connectors to the correct location on the main board.
3. Prior to reinstalling the control board, verify that the slotted tabs on the rear of the control mounting board glide into their adjoining locator slots on the control housing.
4. Slide the assembly into position and secure with the 5/16" sheet metal screw.
5. Replace the center mullion, lower access panel, toe grill, and door.



WARNING

Prior to removing the access cover to the machine compartment, disconnect the supply voltage to the appliance. Failure to do this could result in an electrical shock or possible death.

19.2.3 Thermistor (Sensor):

Thermistors can be checked by use of a multi-meter with the ability to read resistance. Refer to the resistance chart on page 191.

19.2.3.1 Bin Thermistor

The **bin thermistor** senses the interior temperature allowing the control to adjust and properly display the interior temperature. The thermistor is located at the mid, left hand wall. The thermistor is covered with a plastic shield to prevent accidental damage.

The bin thermistor looks to "Start" a production mode at 43°F and to "Stop" ice production at 37°F.

19.2.3.2 System Thermistor

The **high side (System) thermistor** senses the system temperature at the filter drier inlet (liquid line). Higher temperature variations will have a negative effect on ice production. Possible effects could be caused by a higher ambient temperature or possibly a condenser air restriction.

To account for these changes, the main control board is programmed to compensate by either adding or subtracting a factor to the compressor "On Time" for every 1°F change the system thermistor senses in temperature change. This adjustment will ensure that the ice maker continues to produce a suitable amount of ice.

19.2.3.3 Checking Thermistors

The bin and high side thermistor harnesses from the control board are foamed in place. The recommended method to ohm the thermistor is to remove the thermistor connector at the control board and take the reading.

19.2.3.4 Removing the Bin Thermistor

1. Remove both the upper and lower access covers on the rear of the ice machine.
2. The base assembly can be slid out 8-10" to help this conversion. (See Section 5 for guidance).
3. Remove the permagum and foam insulation out of the rear bun hole where the thermistor is routed inside to out.
4. Disconnect the bad thermistor at the main power board connector plug.
5. Remove the two screws holding the bin thermistor shield.
6. Remove the thermistor bulb from the shield.
7. Remove the following components:
 - Escutcheon cover
 - Ice deflector
 - Grid cutter
 - And if necessary, the water reservoir
8. Remove the old thermistor cable.

19.2.3.5 Installing the Bin Thermistor

1. Carefully route the new thermistor cable and ensure that there is enough length to connect thermistor at termination points on each end.
2. Repack the bun hole with the insulation products removed previously.
3. Carefully install all components removed in step 7 above.
4. Place the new thermistor into its protective shield. The underneath side of the shield is fitted to accommodate the grooves on the thermistor bulb. Reattach to the bin sidewall.
5. Connect the thermistor to the appropriate spot on the main power board.
6. Reassemble the remaining mechanical section to the main cabinet and secure rear access covers.

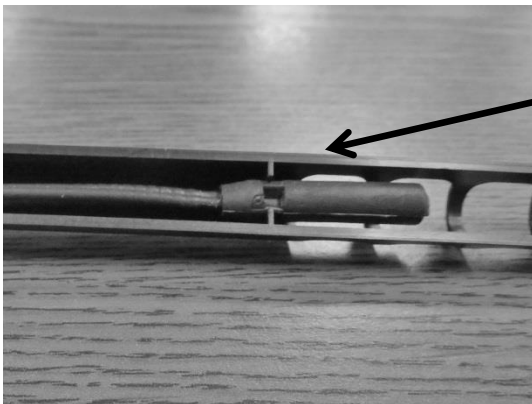

Bin Thermistor: NOTE the locator slot inside the thermistor shield. The grooved thermistor bulb fits firmly in place inside the shield.

Bin sensor
location.



19.2.3.6 Removing the High Side Thermistor

1. The base assembly can be slid out 8-10" to help this conversion. (see section 5 for guidance). Remove both the upper and lower access covers on the rear of the ice machine to gain access.
2. Locate the thermistor connected to the liquid line at the filter drier inlet.
3. Cut the nylon zip tie holding the thermistor to the evaporator plate.
4. Disconnect the bad thermistor at the main power board connector plug and remove.

At the time of this publication, the bin thermistor is a one piece assembly. Replacing the thermistor will require removing the upper and lower rear panels, the interior escutcheon panel, deflector panel, grid cutter, and the water reservoir.

Care in routing the thermistor wire is a concern to ensure that proper wire length is needed to make the connection on the main power board.

DO NOT pull on the thermistor wire, this could cause damage to the replacement thermistor.

19.2.3.7 Installing the High Side Thermistor

1. Attach the new thermistor onto the same liquid line position (filter/drier) and firmly secure with the zip tie.

2. Feed the thermistor through the machine compartment and attach the connector to the corresponding terminal on the main power board.
3. Reassemble the base and access covers in reverse order as they were removed.

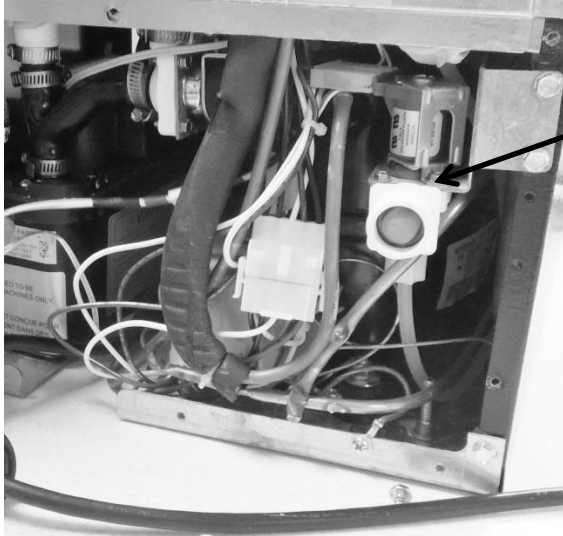

High side thermistor location: The thermistor is located on top of the filter drier inlet (located behind the fill valve). The water valve will have to be removed for access.

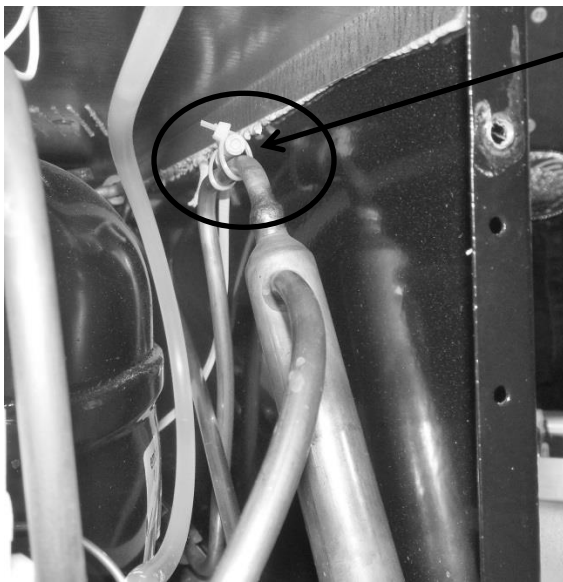

High side thermistor location: The thermistor is fastened to the liquid line at the filter drier with a nylon wire tie.

At the time of this publication; the thermistor is a one piece assembly. Replacing the thermistor will require rerouting the thermistor wire to the main control board in the machine compartment.

19.2.3.8 Thermistor Harness Identification

1. Bin sensor, (orange) labeled: "Low Temp"
2. High side sensor, (red) labeled: "Defrost Evap."

19.2.4 Temperature Resistance Chart:

C°	F°	Resistance Min.	Resistance Normal	Resistance Max.	C°	F°	Resistance Min.	Resistance Normal	Resistance Max.
-18	0	59.891	61.606	63.364	33	91	7.361	7.458	7.554
-17	1	57.14	58.748	60.396	34	93	7.1	7.195	7.291
-16	3	54.53	56.038	57.583	35	95	6.849	6.944	7.039
-15	5	52.053	53.468	54.916	36	97	6.609	6.702	6.796
-14	7	49.702	51.029	52.387	37	99	6.377	6.47	6.563
-13	9	47.47	48.715	49.987	38	100	6.156	6.247	6.339
-12	10	45.35	46.518	47.711	39	102	5.943	6.033	6.124
-11	12	43.336	44.432	45.55	40	104	5.738	5.827	5.918
-10	14	41.422	42.45	43.499	41	106	5.542	5.63	5.719
-9	16	39.603	40.567	41.551	42	108	5.353	5.44	5.528
-8	18	37.874	38.778	39.7	43	109	5.171	5.257	5.344
-7	19	36.229	37.077	37.942	44	111	4.997	5.082	5.167
-6	21	34.664	35.46	36.271	45	113	4.829	4.913	4.997
-5	23	33.175	33.922	34.683	46	115	4.668	4.75	4.834
-4	25	31.758	32.459	33.172	47	117	4.513	4.594	4.676
-3	27	30.409	31.067	31.735	48	118	4.364	4.444	4.525
-2	28	29.125	29.741	30.368	49	120	4.22	4.299	4.379
-1	30	27.901	28.48	29.067	50	122	4.082	4.16	4.239
0	32	26.736	27.278	27.829	51	124	3.95	4.026	4.103
1	34	25.625	26.133	26.65	52	126	3.822	3.897	3.973
2	36	24.566	25.043	25.527	53	127	3.699	3.773	3.848
3	37	23.556	24.004	24.457	54	129	3.58	3.653	3.727
4	39	22.594	23.013	23.437	55	131	3.466	3.537	3.61
5	41	21.675	22.068	22.466	56	133	3.356	3.426	3.498
6	43	20.799	21.167	21.54	57	135	3.25	3.319	3.389
7	45	19.963	20.308	20.657	58	136	3.148	3.216	3.285
8	46	19.164	19.488	19.814	59	138	3.049	3.116	3.184
9	48	18.402	18.705	19.011	60	140	2.954	3.02	3.087
10	50	17.674	17.958	18.244	61	142	2.863	2.928	2.994
11	52	16.979	17.244	17.512	62	144	2.775	2.838	2.903
12	54	16.315	16.563	16.813	63	145	2.69	2.752	2.816
13	55	15.68	15.912	16.146	64	147	2.608	2.669	2.732
14	57	15.073	15.29	15.508	65	149	2.529	2.589	2.65
15	59	14.492	14.695	14.899	66	151	2.452	2.511	2.572
16	61	13.937	14.127	14.317	67	153	2.379	2.437	2.496
17	63	13.406	13.583	13.761	68	154	2.307	2.365	2.423
18	64	12.898	13.064	13.23	69	156	2.239	2.295	2.352
19	66	12.412	12.566	12.721	70	158	2.172	2.228	2.284
20	68	11.947	12.091	12.235	71	160	2.108	2.163	2.218
21	70	11.502	11.635	11.77	72	162	2.047	2.1	2.154
22	72	11.075	11.2	11.324	73	163	1.987	2.039	2.093
23	73	10.666	10.782	10.898	74	165	1.929	1.98	2.033
24	75	10.275	10.383	10.491	75	167	1.873	1.924	1.975
25	77	9.9	10	10.1	76	169	1.82	1.869	1.92
26	79	9.533	9.633	9.733	77	171	1.767	1.816	1.866
27	81	9.182	9.282	9.382	78	172	1.717	1.765	1.814
28	82	8.846	8.945	9.045	79	174	1.668	1.715	1.763
29	84	8.523	8.622	8.721	80	176	1.621	1.667	1.714
30	86	8.214	8.313	8.411	81	178	1.576	1.621	1.667
31	88	7.918	8.016	8.114	82	180	1.532	1.576	1.622
32	90	7.634	7.731	7.828					

19.2.5 Door Sensor:

The door sensor is located on the bottom cabinet flange; approximately one third of the distance away from the handle side of the cabinet.

The door sensor is resistance activated by the pressure of the door gasket. Light functionality and the door alarm are directly related to this switch.

Door sensor location.

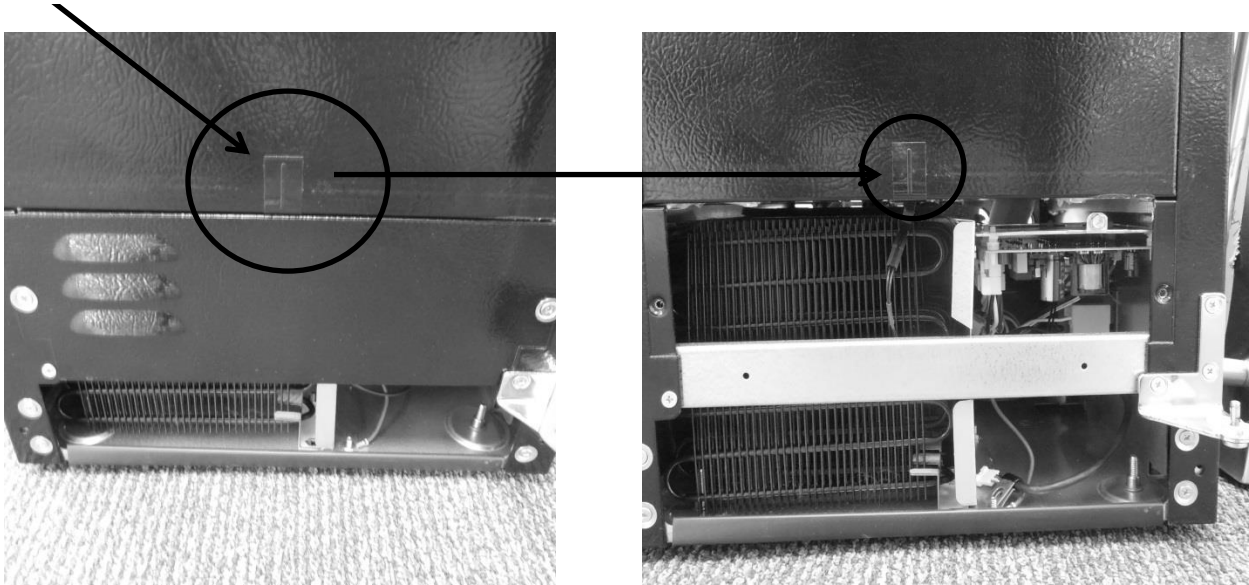

Sensor disconnect terminal.

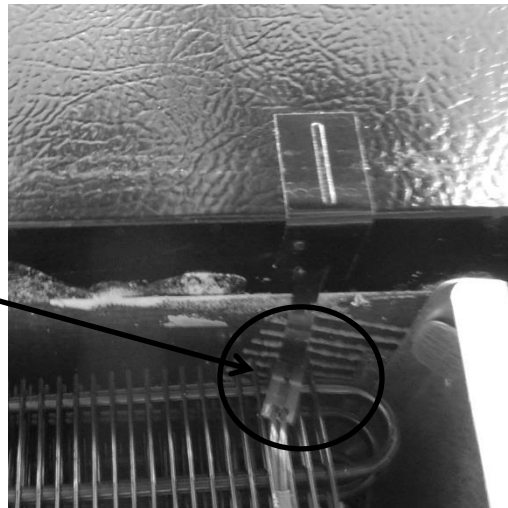

19.2.5.1 Door Sensor Removal

1. Remove the toe grill.
2. Disconnect the door sensor at the harness terminal behind the trim piece. See photo.
3. Remove the door sensor from the cabinet by starting in one of the upper corners and peeling in a downward motion.
4. Once the sensor has been removed from the flange area:
 - a. Grasp the sensor with the right hand using the thumb and forefinger.
 - b. Grasp the electrical strip portion of the sensor between the thumb and forefinger on the right hand.
5. Slowly work the sensor through the gap on the lower trim section to remove. The upper portion of the electrical strip has some adhesive backing so care is advised.



Peel away from cabinet flange.



Sensor removed.

19.2.5.2 Door Sensor Replacement

1. Do not remove the adhesive backing from sensor until it is in place.
2. Slide the new sensor into the gap between the bottom flange and trim piece.
3. Once the sensor is in place:
 - a. Remove the adhesive backer from sensor.
 - b. Ensure the sensor is in position and carefully adhere to the cabinet. Apply carefully using thumb pressure to the outer perimeter of the door sensor.
 - c. **NOTE: Care should be taken not to apply unnecessary pressure directly on the raised vertical center of the sensor face. The switch is pressure sensitive; any undue pressure could damage the sensor.**

19.2.6 Error Codes:

- **Thermistor (Sensor) Error Detection**

Temperature thermistors are monitored continuously by the main power board. Any “OPEN, SHORTED, or OUT of RANGE” thermistor circuit will initiate an alarm.

If an error is detected, the ice machine will immediately shut down and the display interface will flash the corresponding fault code continuously. No audible alarm will sound.

- **Communication Error**

Loss of communication between the main power board and the user interface will result in either a continually flashing “ON” or “OFF” on the display.

19.3: Interior Features

19.3.1 Escutcheon Cover:

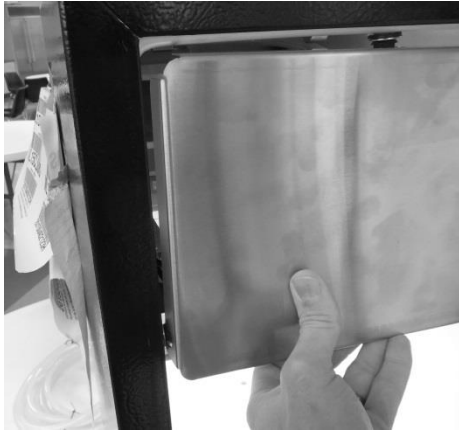

To Remove the Cover: Grasp the bottom of the cover with both hands and pull outward.

To Replace the Cover: Align the top of the cover to the top center mounting peg. Lightly tap with the side of your fist, or push firmly into place. The sides of the cover can now be pushed into place.

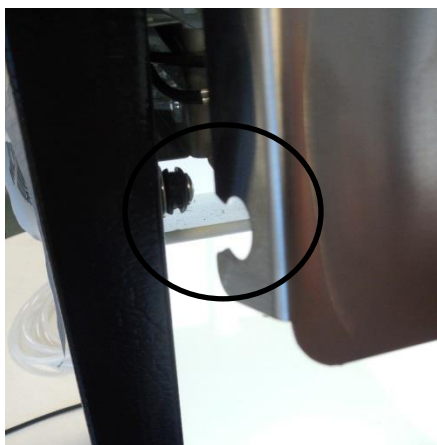
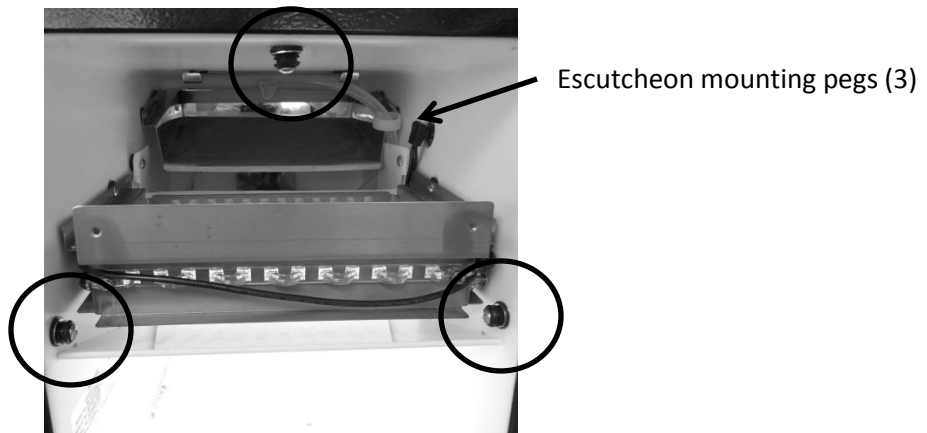

Note: The notched escutcheon cover and rubber mounting pegs.

The cover will be secured, once placed and pushed over the rubber mounting pegs.

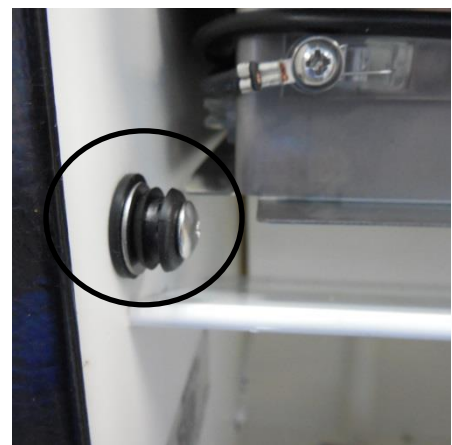

19.3.2 LED Lighting:

One LED light is located on the front side of the lower bin.

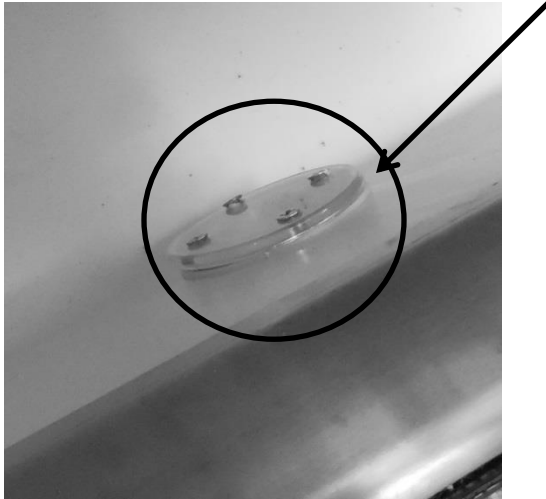

The LED lighting is controlled by the door switch mounted on the bottom flange of the cabinet. Pressure from the door gasket makes and breaks the door switch circuitry to control light function with door openings and closings.

INTERIOR LIGHTING

LED lighting is controlled by the door switch. Lighting ON (door switch OPEN) begins with a smooth ramp up effect whereas the lights come on from 0% to 100% within a 2 second period. Lighting OFF (door switch CLOSED) begins immediately after sensing the door switch.

Additional lighting features can be reviewed in the controls operation section in this manual.

19.3.2.1 Replacing the LED Light

1. Remove both Phillips screws in lens cover; the LED assembly can now be removed.
2. Disconnect the connector plug to replace LED.
3. Reverse process to install.

19.3.3 Grid Cutter:



The grid cutter installed.

NOTE: the water deflection shield over the rear and the ice deflector installed below the grid cutter.

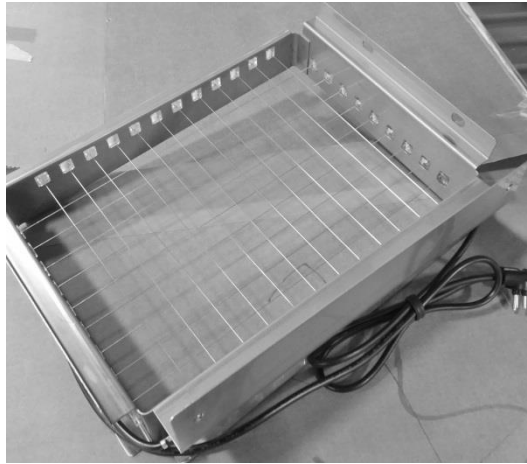

The grid cutter removed:

NOTE: Care must be taken when handling the grid cutter. One broken wire will disable the entire grid.

To enable the grid cutter the grounded power plug needs to be connected at the receptacle located on the mid side wall of the machine above the grid.



19.3.4 Water Deflection Shield:



The water shield is slotted and suspended by the two hooks mounted at the rear top of the ice machine.

The shield helps prevent spray from the distributor tube from extending outward.

19.3.5 Water Distributor Tube:

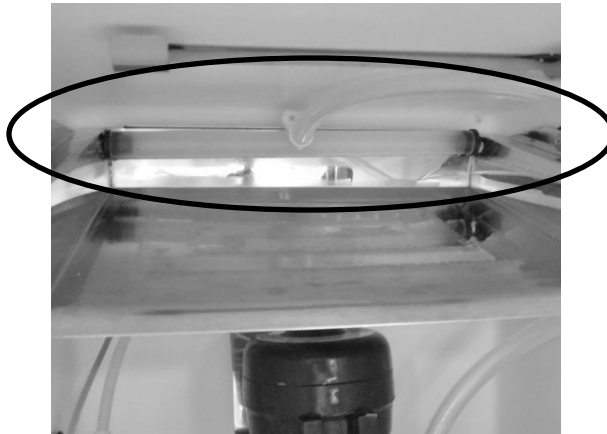

The distribution tube is located above the evaporator plate and is held in place with the two black rubber plugs that are inserted into each end and placed into the holes on each end of the evaporator plate.

NOTE: the proper installation of the distributor tube. The supply line is mounted towards the top of the cabinet and secured in place.

NOTE: The holes in the distributor tube need to be facing the evaporator plate to ensure proper water flow over the plate.

If the holes in the distributor tube are facing upward, the tube needs to be repositioned or the ice machine will not work properly.

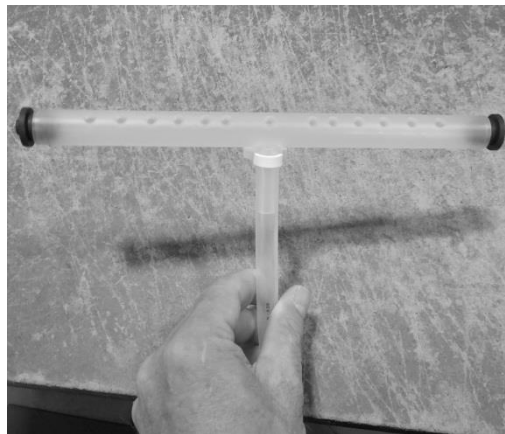

19.3.6 Water Fill Tube:

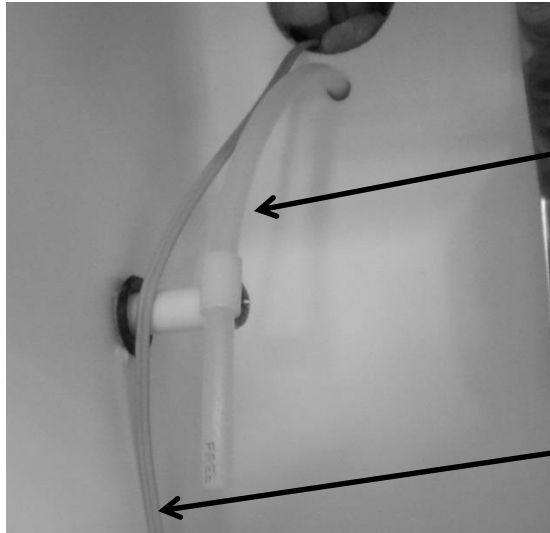

¼" nylon fill tube, from water valve

Bin thermistor cable

19.3.7 Ice Deflector:



Plastic deflector plate; has two tabs (see below) located on the front and rear of each end to secure into side walls of cabinet.

To remove the plate; press down on the center of the plate to disengage from the locator holes.

To reattach, insert the tabs in the holes on one side of the liner, lift the other end of the deflector until it locates itself into the like holes on the opposite side of the liner wall.

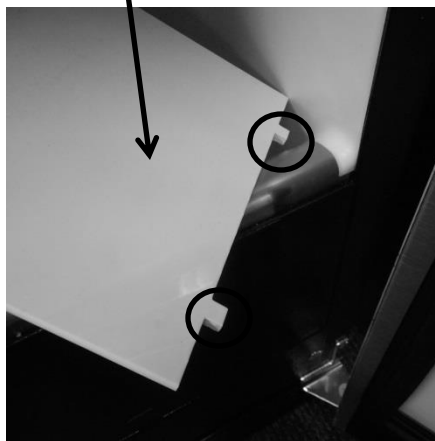

19.3.8 Circulation Pump and Water Reservoir:

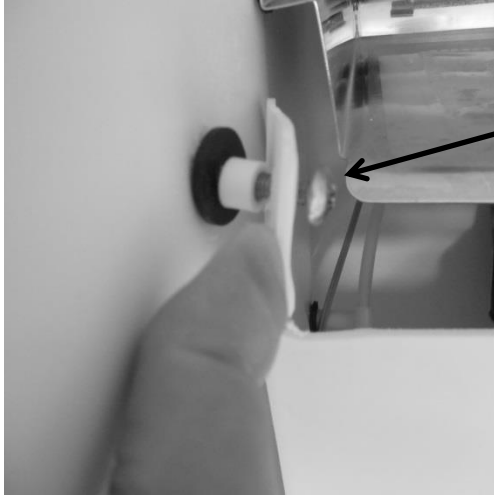

To access the circulation pump, fill tube, water line, water reservoir, or thermistor:

- Remove the two Philips screws securing the water reservoir to the side walls.

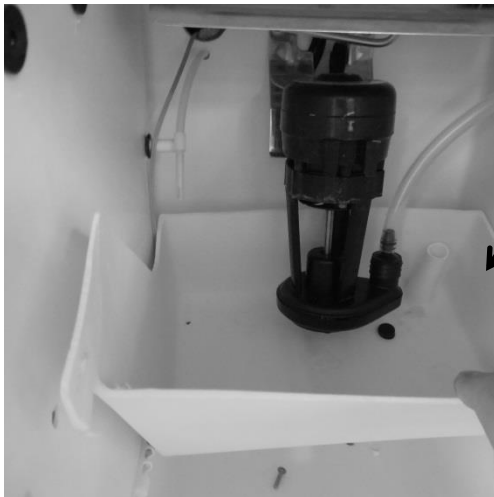

The reservoir can now be removed by lifting off the bottom drain extension.

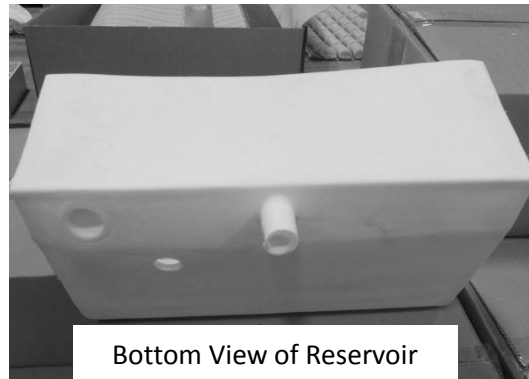

Bottom View of Reservoir



To replace the circulation pump:

- Unplug the pump from the back wall.
- Remove the two Philips screws securing the bracket to the back wall.

19.3.9 Recirculation Barrier:

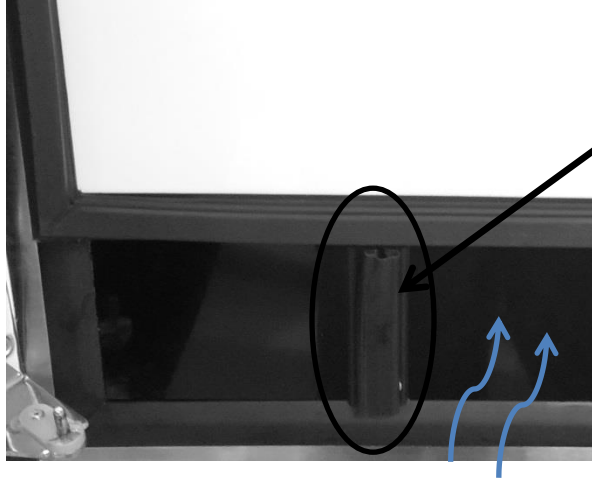

Air recirculation barrier mounted vertically on the bottom of the inside door panel. This allows additional intake air flow into the condenser.

Air louvers to supply additional intake air to the condenser.

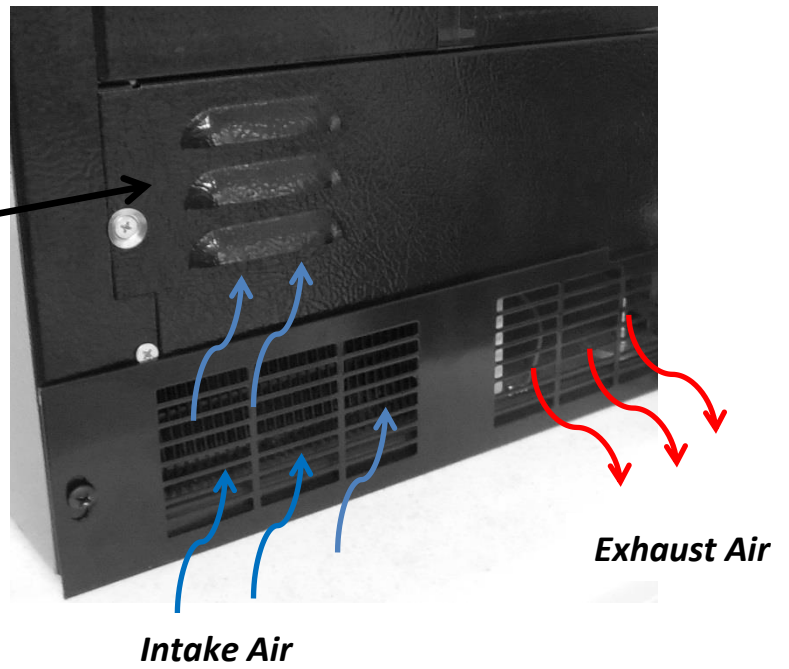

19.3.10 Interior Exploded View:

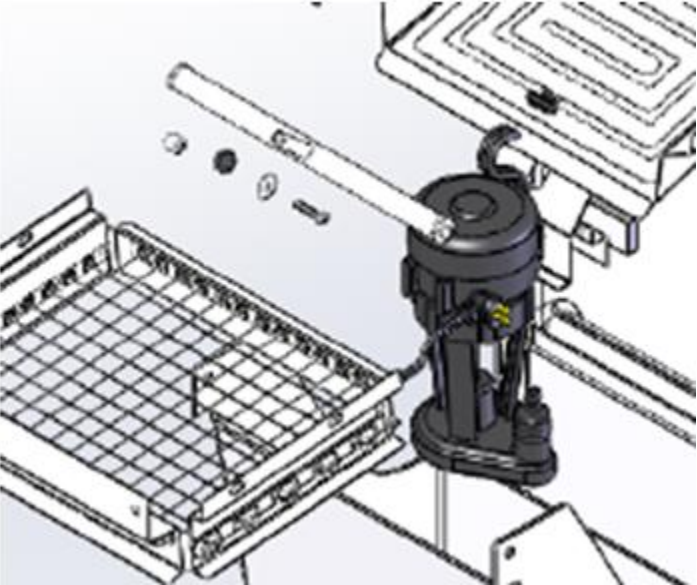
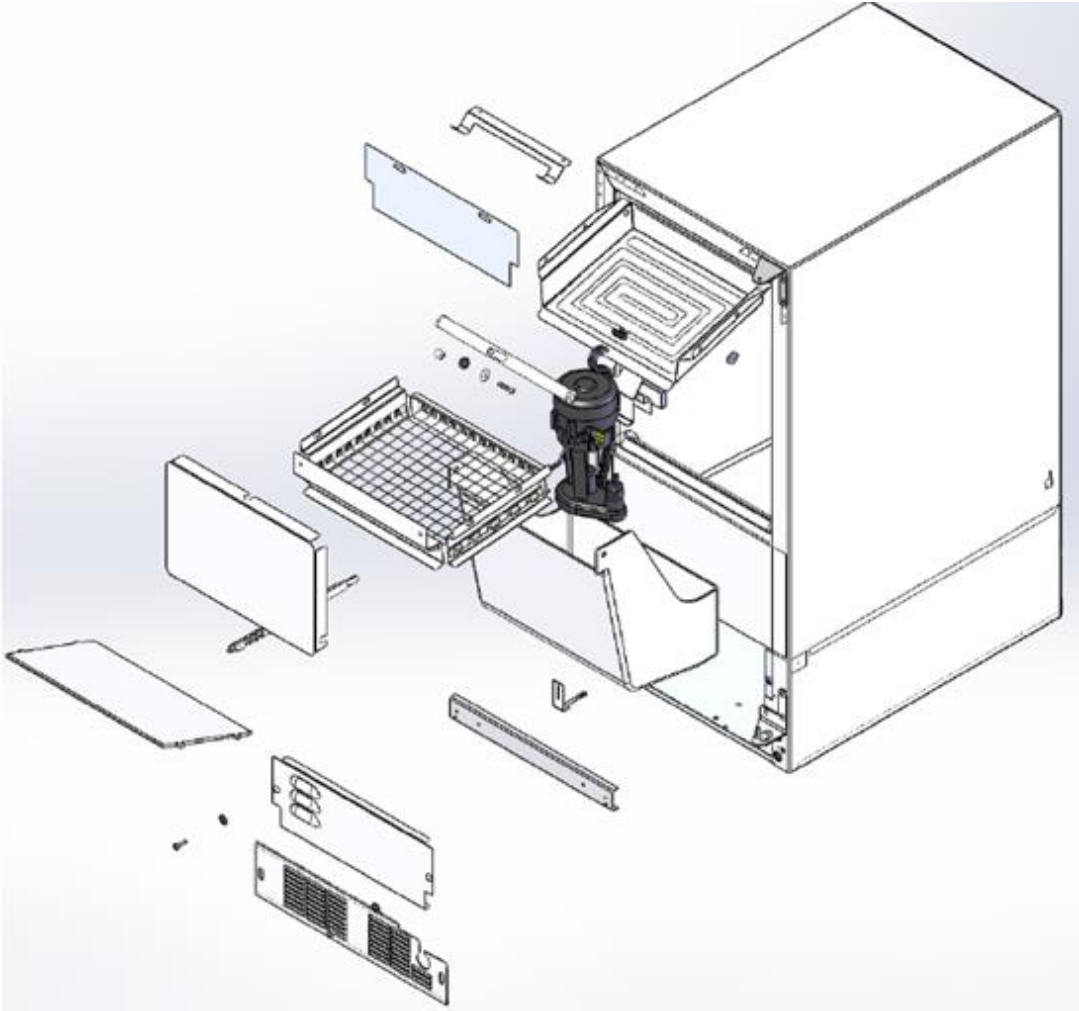

19.4: Machine Compartment Components

19.4.1 Toe Grill Removal:

- 1. Remove both Phillip screws on each end of the toe grill.
- 2. There is an oval spacer held in place by each screw, located behind the toe grill. This is to improve the aesthetic appearance once the grill is adjusted and tightened.



Remove each Phillip screw on both ends of the toe grill.



Right and left hand views of the toe grill, screw and spacer.

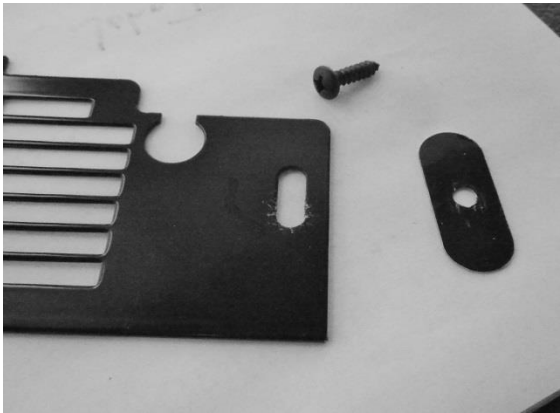



Remove each Phillip screw on each side of the louvered access panel to gain additional access.

NOTE: When reinstalling the toe grill care must be taken to be sure that the communication cable is routed through the correct area in the toe grill.

- The below left hand photo shows the correct routing of the communication cable, it must pass freely with clearance on all sides.
- The below right hand photo shows the incorrect routing of the communication cable. It is very easy for the cable to end up in this position if care is not taken when reinstalling the toe grill. This is a critical pinch spot and will create a service call in the future with either a frayed or cut cable.

➤ **NOTE:** Always ensure that the plastic cable grommet is installed correctly.



CORRECT Wire Position- Inside Grommet.



INCORRECT WIRE POSITION.

19.4.2 Warnings and Cautions:

WARNING

Prior to removing the access cover to the machine compartment, disconnect the supply voltage to the appliance. Failure to do this could result in an electrical shock or possible death.

CAUTION

All electrical parts and wiring must be shielded from torch flame. **DO NOT** allow torch to touch insulation; the insulation will char at 200°F and flash ignite (burn) at 500°F. Excessive heat will distort the plastic liner.

19.4.3 Mechanical Compartment:

 **WARNING:** The refrigeration system must be evacuated prior to unsoldering the compressor or any other system related component.

Access to the mechanical compartment is located at the rear of the unit. Most mechanical and electrical components on the unit mount directly to the slide out base.

To gain access to the mechanical section proceed as follows; be sure to reference the photos as called out.

1. For access to the machine compartment remove the screws securing the bottom compartment panel at the rear of the cabinet.
2. For additional service needs, it may be necessary to slide the machine compartment assembly out. Proceed with the following steps.
 - Remove the rear, upper access panel.
 - Back out the two Phillips screws (1 on each side) on the toe grill.
 - Once the toe grill is removed, it will be necessary to remove all four screws (two on each side) to loosen the mechanical assembly from the front.
 - At the rear bottom corner of the unit two (1 on each side) 5/16" hex head screws can be removed.
3. The mechanical section can now be slid out no more than 8 - 10" maximum until the suction line has been unsoldered from the compressor.
 -  **CAUTION:** To avoid kinking the suction line assembly - do not slide the mechanical base outward past the 8-10" maximum recommended above.
4. To change the HGV or condenser it is necessary to evacuate and reclaim the refrigerant from the system prior to this step.

FRONT OF ICE MACHINE

Remove both top and bottom screws on each side.

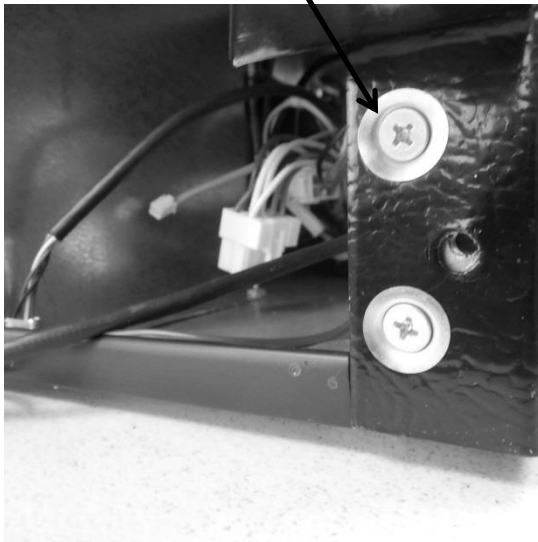
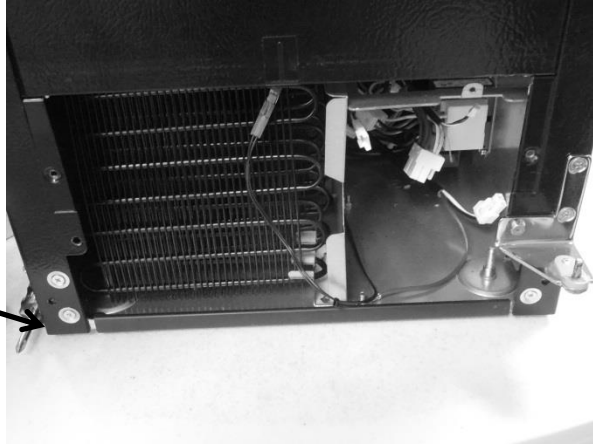

REAR OF ICE MACHINE

Remove all perimeter 5/16" screws from the access panel of the lower machine compartment.— DO NOT remove the 5/16" screws in the bottom left and right hand side corners, or the Philips head ground screws.

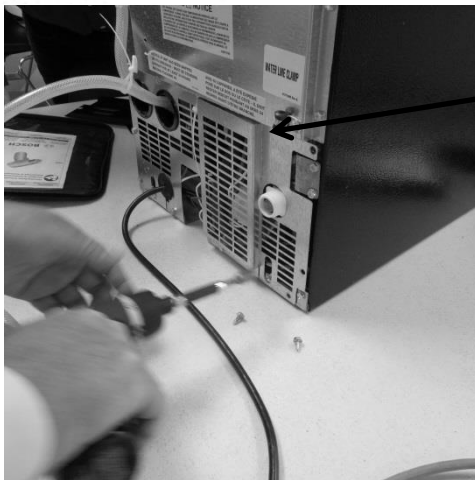



Remove corner screw on each side of rear cabinet.

Before the mechanical assembly can be slid outward the following components must be disconnected and removed.

- Water fill valve
- Drain valve
- Drain “Y” connector
- Drain pump

19.4.4 Water Fill Valve:

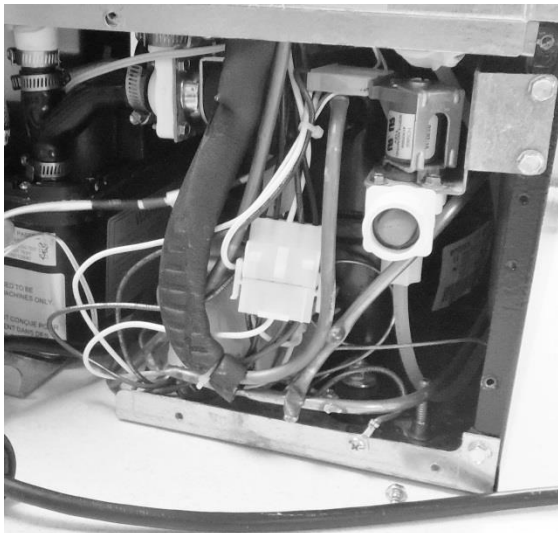

To remove the water valve, disconnect:

- Wiring harness on solenoid.
- Water connection on bottom of valve.
- Remove both 5/16” sheet metal screws securing the valve bracket to the side flange of the machine compartment.

19.4.5 Drain Valve:



To remove the drain valve, disconnect:

- Wiring harness on the solenoid.
- The two hose clamps. One on the top of the valve body and the second on the side of the valve body where it connects to the “Y” connector.
- Remove both Philips sheet metal screws securing the valve bracket to the top of the machine compartment.
- Remove the valve body from the two drain hose connections.

19.4.6 Drain “Y” Connector:



To remove the “Y” connector, disconnect:

- Loosen the two remaining hose clamps on the top and bottom of the “Y”.
- The “Y” is flexible so it will ease in the removal.
- Remove the “Y” from the upper nylon union and the connection at the drain pump.



Mechanical assembly completely unsoldered and removed from under the cabinet.

19.4.7 Rear View – Exploded Parts:

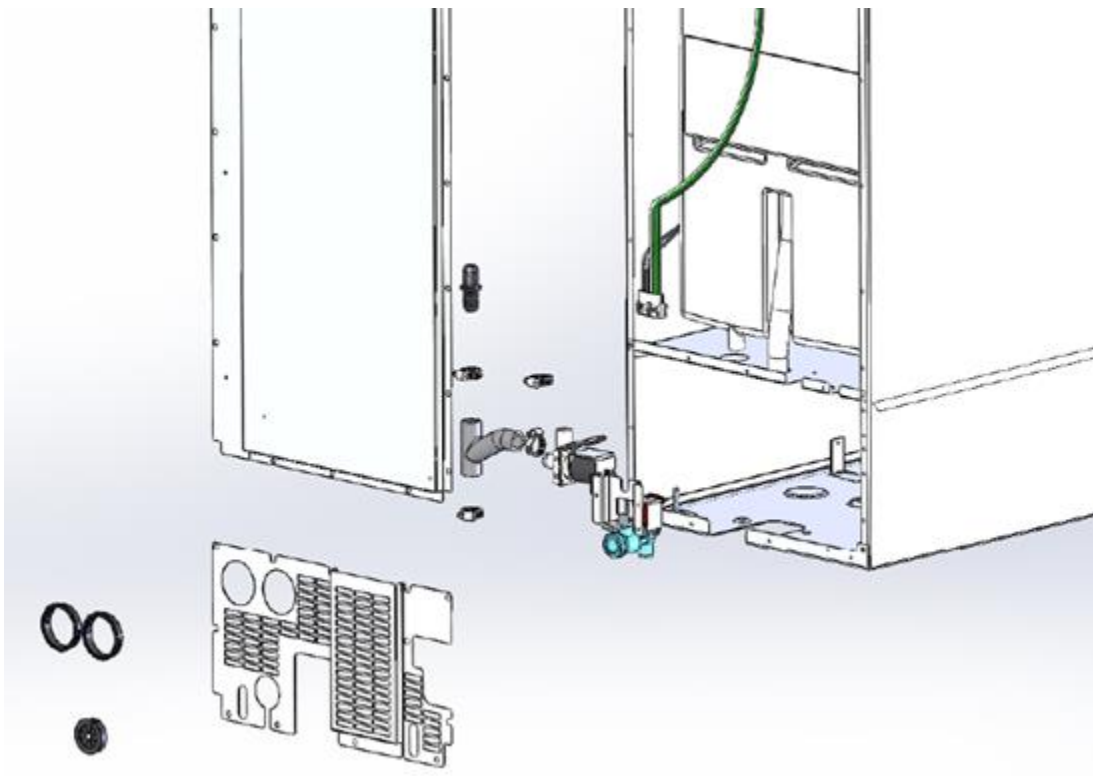

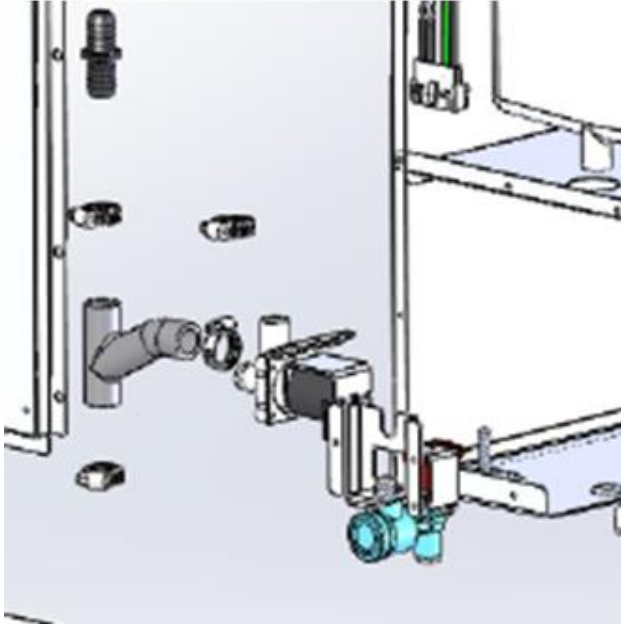

19.4.8 Compressor:

The following tests should be conducted before concluding the compressor is faulty.

1. Low and high side pressure, temperature of compressor, discharge and suction lines, temperature of air leaving the evaporator compartment, temperature of condenser coil, condenser fan operation, and amp draw at compressor.
2. Use a compressor start cord to isolate and test the compressor.
3. Use an ohmmeter to measure resistance / continuity at the compressor to check for shorted or grounded windings.
 - a. Resistance between the “Common” and “Run” terminals: this will be the lowest ohm reading obtained.
 - b. Resistance between the “Common” and the “Start” terminals: this will be the mid-range ohm reading obtained.
 - c. Resistance between the “Start” and “Run” terminals: this will be the highest ohm reading obtained (This should equal the combined total of the previous two readings).
 - d. No resistance between any two terminals signifies an open winding.
 - e. Check continuity between compressor terminals and the compressor itself (Scrape off a little paint on compressor to make sure that resistance can be measured). If continuity is obtained, the compressor is grounded and needs to be replaced.

19.4.8.1 Check Compressor Winding Resistance:

COLD WINDING RESISTANCE

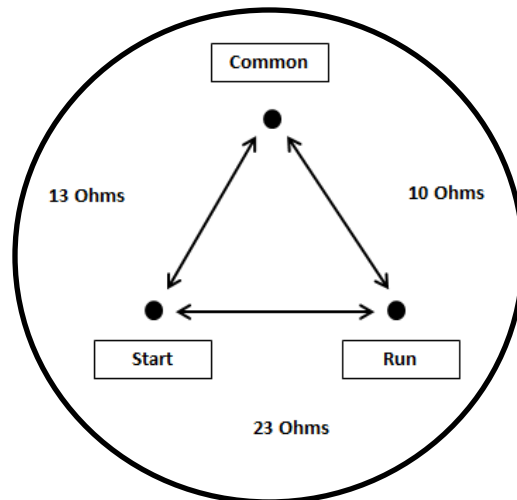

19.4.8.2 Compressor Removal

1. Disconnect power to the unit.
2. Follow the exact steps outlined in “Sealed System Components” to access the compressor.
3. Using the process tubes, install sealed system access valves and recover refrigerant.
4. Remove the TSD2 starter package from the compressor terminals.
5. Unsolder and remove the discharge and suction lines from the compressor.
6. Unsolder and remove the filter / drier.
7. **Cap all refrigeration lines:** It is advisable that all exposed refrigeration lines be capped if the system will be exposed to the atmosphere for any length of time.
8. Remove the three 7/16” nuts, washers and grounding screw(s) from compressor mounting bolts. There is no nut and washer at the back, left hand mounting position.
9. Lift the compressor off the mounting bolts.

19.4.8.3 Compressor Installation

1. Do not remove the rubber plugs from the compressor tubes at this time.
2. Install the four (4) rubber grommets onto the compressor base.
3. Install the three (3) sleeves where the carriage bolts are located.
4. Mount the compressor into position on the mechanical base.
5. Install the three (3) washers and lock nuts and tighten snugly into place. Do not over tighten.
6. Install and solder a new filter drier in the system.
7. Remove rubber plugs from compressor tubes.

8. Solder a new process tube to compressor.
9. Solder the discharge and suction lines back into compressor.
10. Re-install TSD2 starter package to compressor terminals.
11. Connect service ports to both the high and low sides of system.
12. Evacuate, charge to serial plate recommendation, and leak check the sealed system.
13. Push the mechanical base assembly back into place.
14. Secure base assembly to cabinet at rear and front locations.
15. Replace the front grill and back panel.

19.4.9 Condenser:

The condenser is of tube and wire construction. It is draw through; forced air technology used for heat transfer. The front grill facilitates both intake and exhaust air. Inlet air passes both through the toe grill and above the louvered section on the front access panel. The condenser sets in an enclosure that prevents air recirculation. Exhaust air passes over the main control board and out through the toe grill. A baffle on the appliance door also aids in preventing any air recirculation.

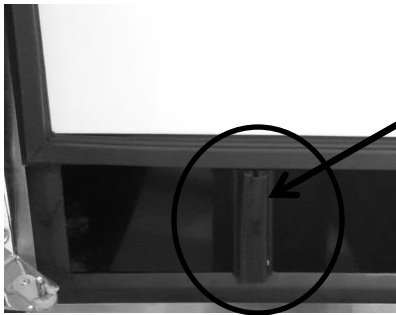

Baffle on the inside, lower door of the appliance helps prevent possible air recirculation.

A common problem with this system is restricted air flow caused by lint, dust, dirt, and pet hair. These particles become built up on the condenser and results in overheating due to the lack of sub-cooling across the coil.

NOTE: Another important factor is that the free air space on the toe grill cannot be altered to meet a certain design criteria. Any modifications could jeopardize the integrity of the appliance performance.

19.4.9.1 Condenser Removal

1. Disconnect power to the unit.
2. Shut off the supply water.
3. Disconnect the drain line and drain any remaining water from the line.
4. Follow these steps to ease in the removal of the base assembly from the machine compartment.

- Remove both upper and lower, rear access panels.
 - Disconnect the door sensor switch.
 - Remove the toe grill and access panel from the front of the machine.
 - Remove screws from all four corners that secure the cabinet assembly to the base assembly.
 - Remove these following components:
 - i. Fill valve, drain valve, “Y” drain connection, and door sensor switch.
5. Install sealed system access valves and recover refrigerant.
 6. Disconnect and cap the suction line from the compressor and the capillary tube from the drier.
 7. Slowly slide mechanical base assembly out from the rear of the appliance.
 8. Disconnect any electrical harness that restricts your progress.
 9. Unsolder and remove the discharge and liquid lines from the condenser.
 10. Using a 3/8” nut driver or socket, remove (1) 3/8” nut securing the outside condenser mounting bracket to the mechanical base. The inner mounting bracket can remain, as the condenser should slide in and out with the bracket remaining in its current position.
 11. The condenser assembly can now be removed from the base assembly.
 12. It is advisable that the un-soldered copper tubes be capped if the system will be exposed to the atmosphere for any length of time.

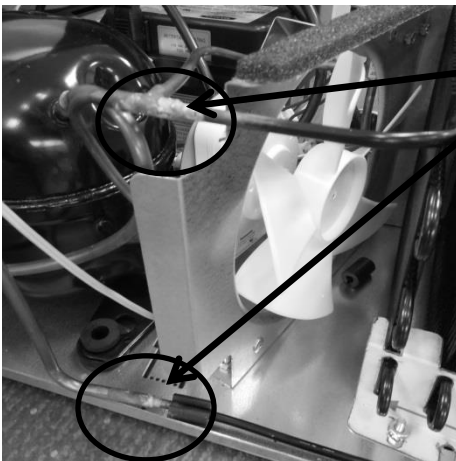

Unsolder the condenser at these two points.



Remove the 3/8" nut and star washer.

This 3/8" nut and star washer should not have to be removed. The condenser will slide in and out of this bracket.



19.4.9.2 Condenser Installation

1. Reattach the condenser to the two mounting brackets.
2. Ensure that the carriage bolts for mounting the condenser brackets are in place on the bottom of the machine compartment.
3. Install and solder the discharge and liquid lines to condenser.
4. Carefully slide the base assembly back in place.
5. Reconnect any electrical harnesses disconnected previously.
6. Install and solder a new filter drier in the system.
7. Evacuate, charge to serial plate recommendation, and leak check the sealed system.
8. Carefully reconnect all electrical terminals back on the terminal board.
9. Secure base assembly to cabinet at rear and front locations.
10. Reconnect the components that were disconnected earlier.
 - a. "Y" connector – secures and tightens all hose clamps.
 - b. Drain valve – secure and tighten all hose clamps.
 - c. Fill valve.
 - d. Door sensor switch and any other harnesses disconnected.

19.4.10 Evaporator:

The evaporator removes heat from water cascading over the plate, ultimately making a full bin of ice within 24 hours (undisturbed cycle). The evaporator plate is “U” shaped in appearance and is installed in the top section of the ice machine behind the escutcheon cover.

(4) Philips pan head screws, 2 on each side, front and rear of the evaporator flange.

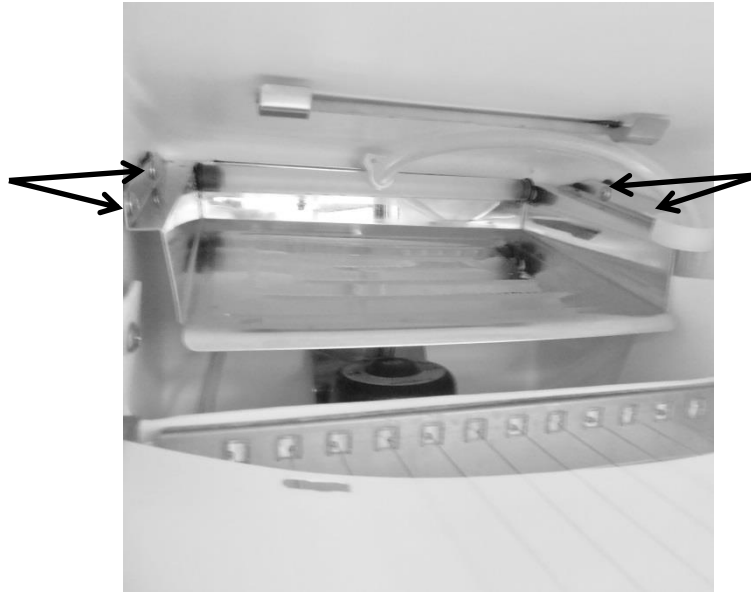

19.4.10.1 Evaporator Removal

1. Disconnect power to the unit.
2. Remove both rear top and bottom access panels.
3. Install sealed system access valves and evacuate and recover refrigerant.
4. Unsolder the suction line, hot gas line, and capillary tube from the filter drier.
5. Remove the appliance door to ease the removal process.
6. Remove the following components from inside the ice machine;
 - Escutcheon cover
 - Ice deflector
 - Water deflector
 - Grid cutter
 - Water distribution tube
7. Remove the four Philips pan head screws (See photo above).
8. Remove all the insulation from the bun hole.
9. Straighten out the disconnected tubing and pull the evaporator and tubing out from the inside and discard assembly.

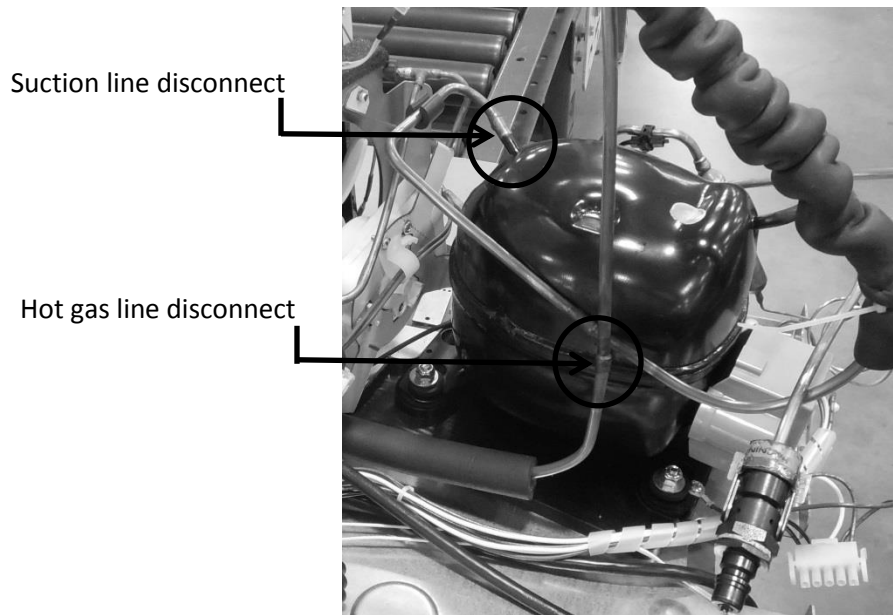

19.4.10.2 Evaporator Installation

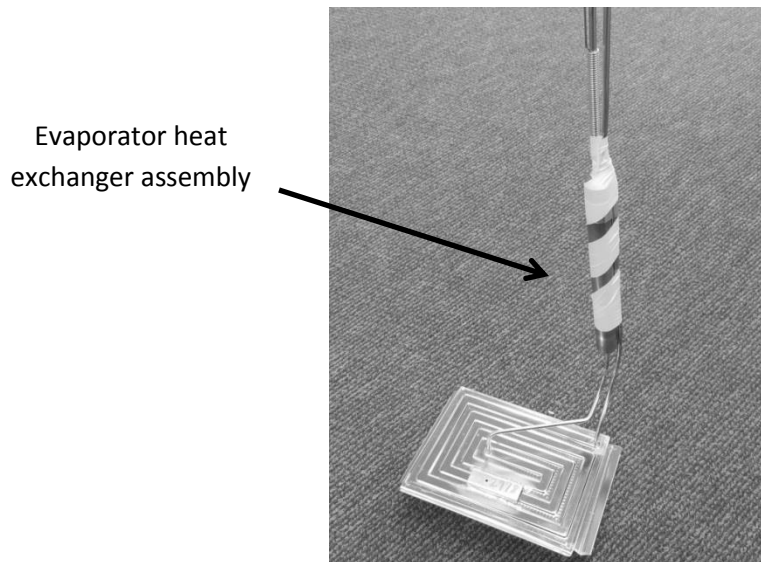

1. Straighten out the tubing on the new assembly so that it can be installed.
2. Slide the tubing inside the ice machine and outward through the bun hole.
3. Bend the suction tubing outside the machine by thumb, taking care not to kink the lines.
4. Carefully extend the tubing down the back of the machine and route tubing as was the previous assembly.
5. Install a new filter drier.
6. Remove caps from tubing and solder lines into place.
7. Place insulation back into bun holes.
8. Screw evaporator back into place using the 4 pan head screws.

9. Leak check, pull a satisfactory vacuum, and recharge with R134A according to the data on the serial plate.
10. Carefully slide the machine back into place and reconnect all components removed from the outside of the machine.
11. Carefully reassemble the interior components removed.
12. Check drain to ensure it is not compromised.
13. Turn on the water supply to make ice.

19.4.11 Interior Components - Exploded View:

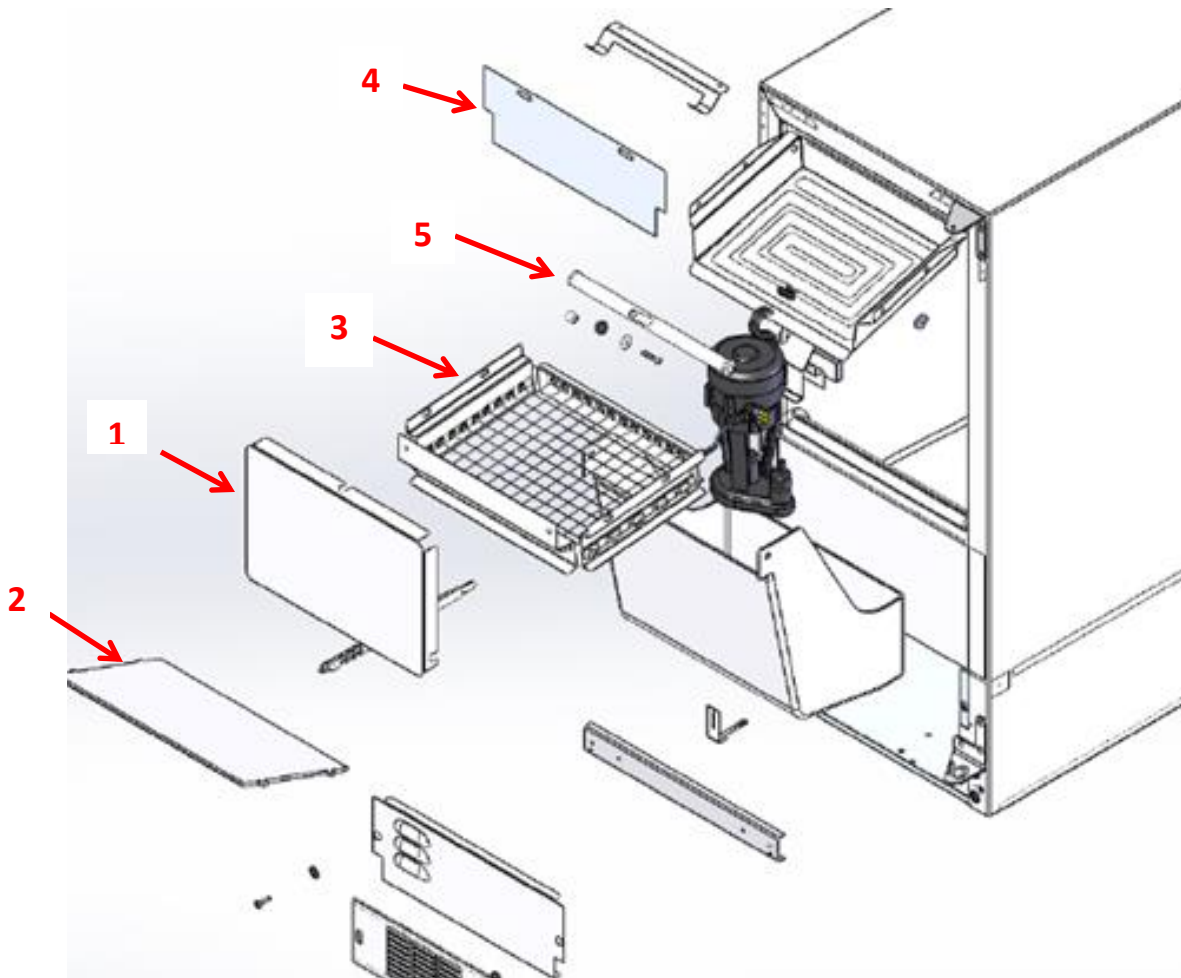

To access the evaporator plate, first remove the following:

1. Escutcheon cover
2. Ice deflector
3. Grid cutter
4. Water deflector
5. Distribution tube assembly

19.4.12 Hot Gas Valve (HGV):

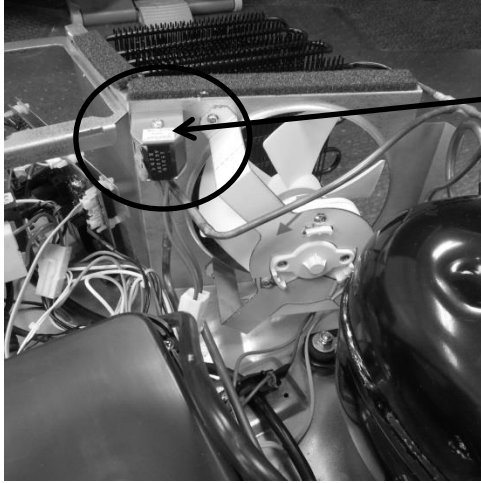

Hot gas valve is located on the rear of the condenser shroud.

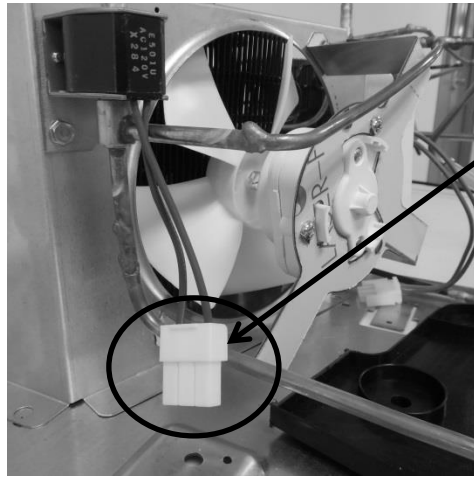

Hot gas valve disconnect is shown in photo.

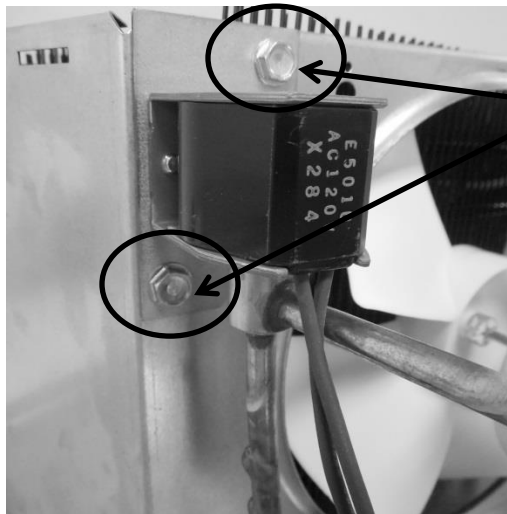

The hot gas valve is secured with two 5/16" sheet metal screws.

19.4.13 Mechanical View – Exploded:

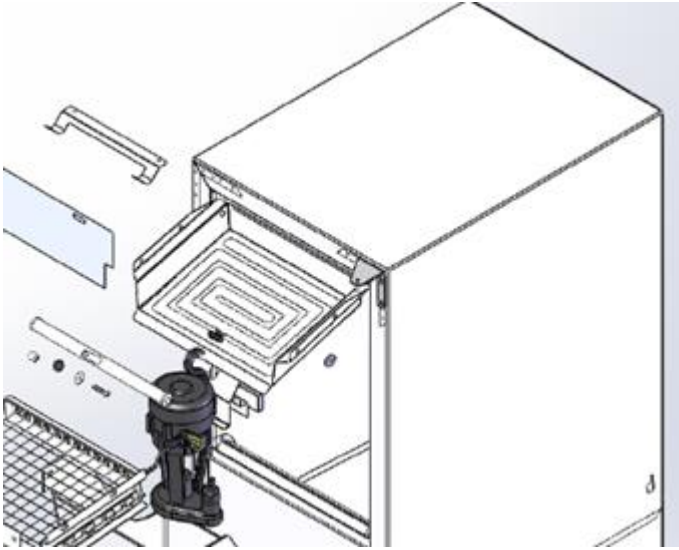
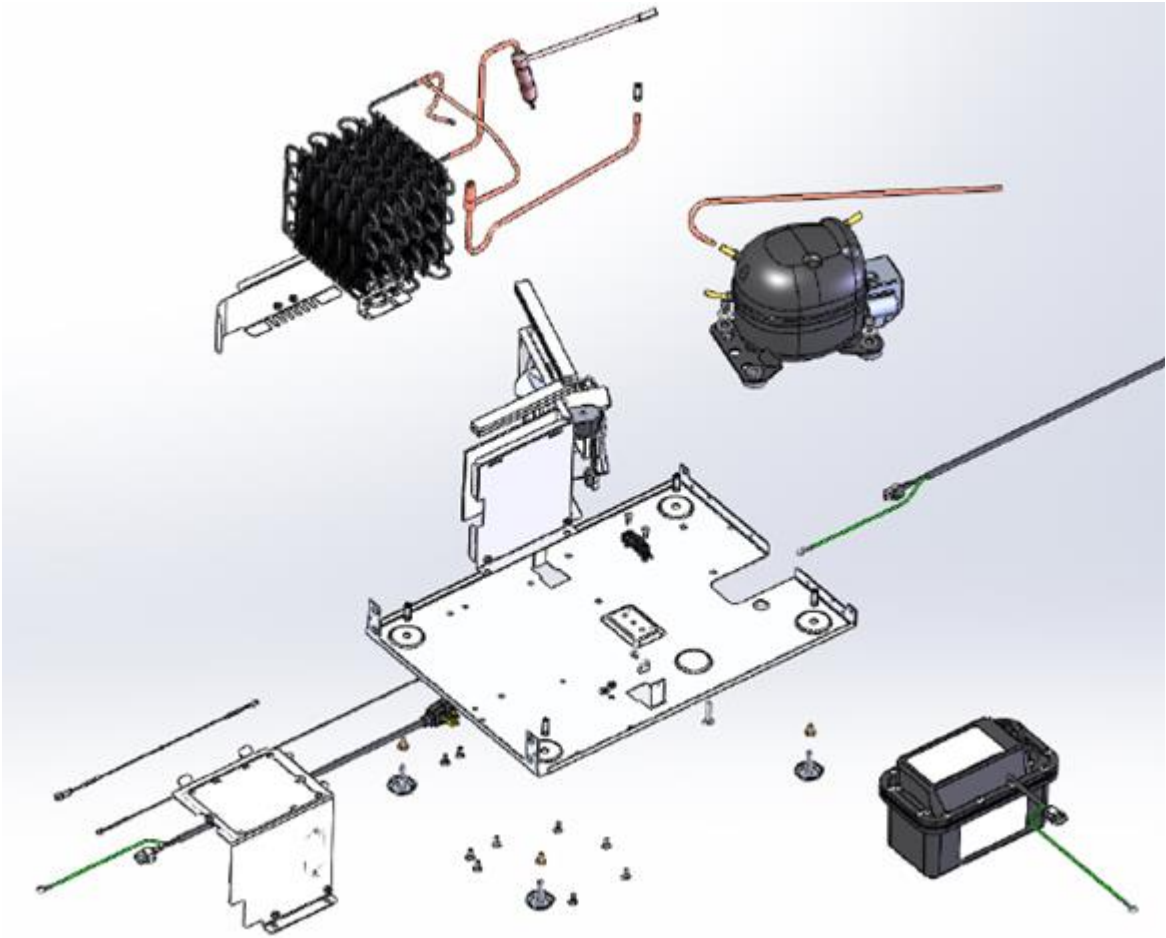

19.4.14 Condenser Fan:

The condenser fan is used to force air over the condenser coil. The condenser fan cycles on and off simultaneously at intervals during the production and harvest cycles.

1. Make sure that the motor shaft turns freely. The blade can be turned in either direction to verify that the shaft is not seized or the blade binding. Watch the blade and listen for any noise that might indicate a problem.
2. Check resistance between the terminals of the motor's power cord. Replace the motor if the windings are shorted (open).

19.4.14.1 Fan Assembly Removal

1. First, remove the fan blade from the motor shaft.
2. Remove the two Phillips screws securing the fan motor to the mounting bracket.
3. The fan assembly can now be lifted clear from the fan bracket and shroud.
4. Disconnect the fan assembly at the connector harness.

19.4.14.2 Exploded View of Condenser Fan assembly

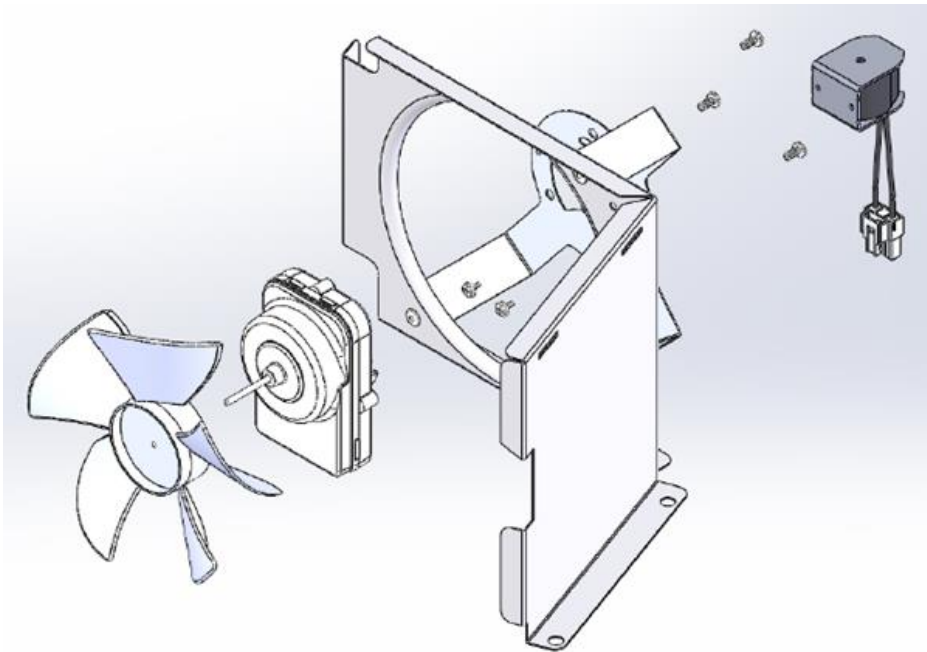

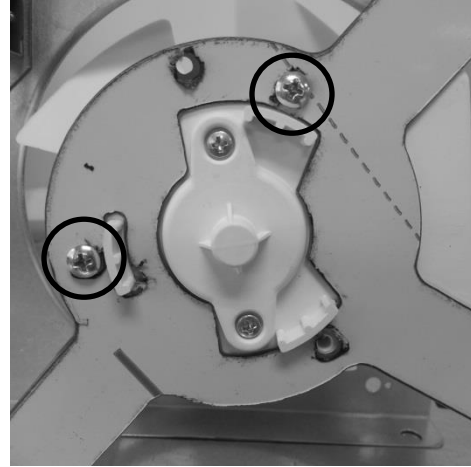
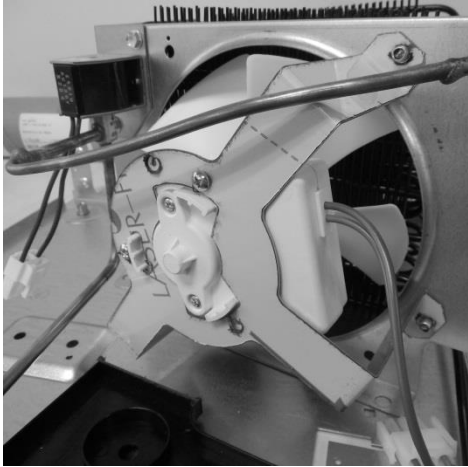

19.4.14.3 Fan Assembly Installation

1. Re-install the fan motor in reverse order that it was removed.

19.4.14.4 Condenser Fan Blade Spacing

If the condenser fan blade has been removed from the motor shaft the fan blade must be properly re-spaced to achieve the optimal performance from the condenser.

- The correct distance from the tip of the fan shaft to the top surface of the fan blade hub is 1/4" (.25")

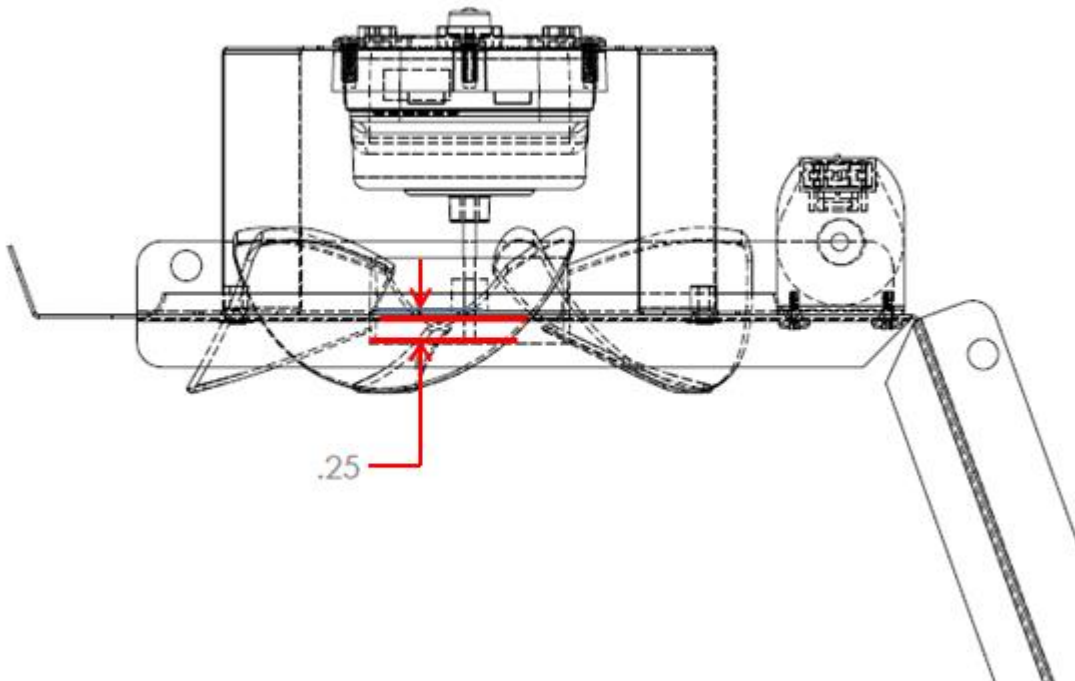

19.4.15 Drain Pump:

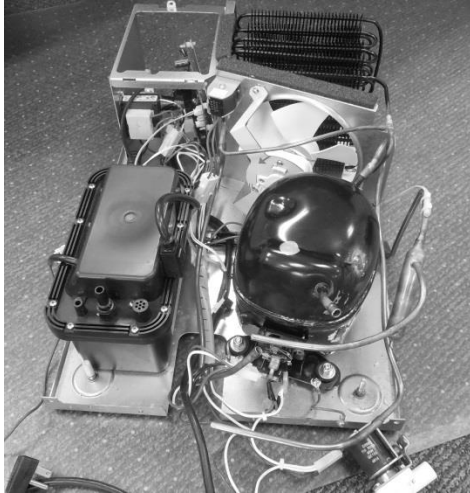

The drain pump sits at the rear, left hand side of the machine compartment base assembly.

Pumping capacity is rated at a maximum of: an 8' vertical lift and a 20' horizontal run.

Any use of a non-manufactures approved drain pump will void the consumer's warranty.



The white connector at the drain pump connects the appliance to the supply voltage receptacle.

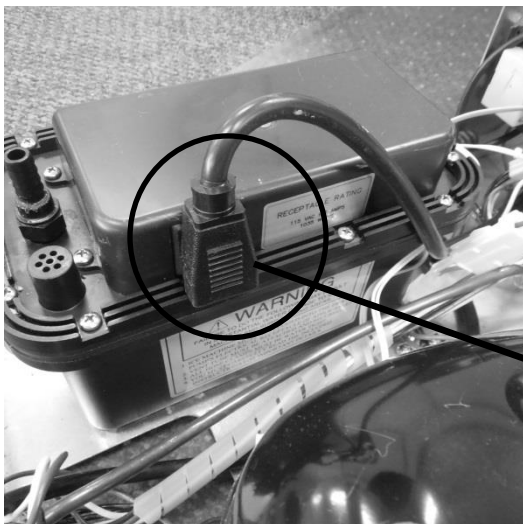
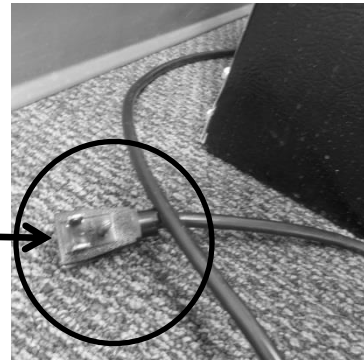

The black power plug on the pump connects to the main power board.

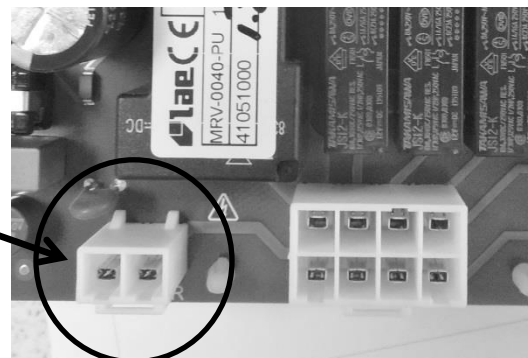

19.4.15.1 Drain Pump Tube Routing



- 1) Pump Inlet, from bin/reservoir.
- 2) Pump outlet, has a maximum limit of 8' vertical lift and 20' horizontal run.
- 3) Pump vent, must be attached vertically to the rear of the cabinet.

NOTE: The ice machine and drain pump need to be winterized once temperatures drop below 40°F to avoid damage caused by water freezing in the water system. Water needs to be drained and lines need to be blown out to preserve the appliance through the cold months.

19.4.15.2 Drain Pump Removal Instructions

The following instructions were taken from the Customers Owners Guide

Drain Pump Removal Instructions:

1. Unplug the ice machine from the electrical supply and remove the rear access cover from the ice machine. (See page 6 for instructions).
2. Unscrew the leveling leg in the back corner until the end of the threaded portion is flush with the threaded nut insert in the base. (see Figure 36).
3. Unscrew the 3 hose clamps and remove the 3 hoses from the front of the drain pump. (See Figure 36).
4. Rotate the drain pump and remove from the ice machine, (See Figure 35). It may be necessary to disconnect the ground wire connection in the back flange of the cabinet. (See Figure 36).
5. Disconnect the ice machine power cord from the drain pump (See Figure 37).
6. To drain water from the pump follow step 14 and 15 on page 26.
7. Installation of drain pump is reverse of this procedure.

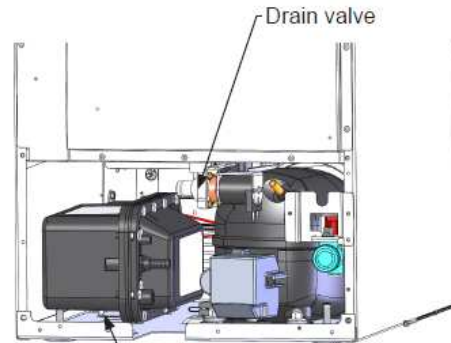

Figure 35

Rotate drain pump and remove from back of ice machine.

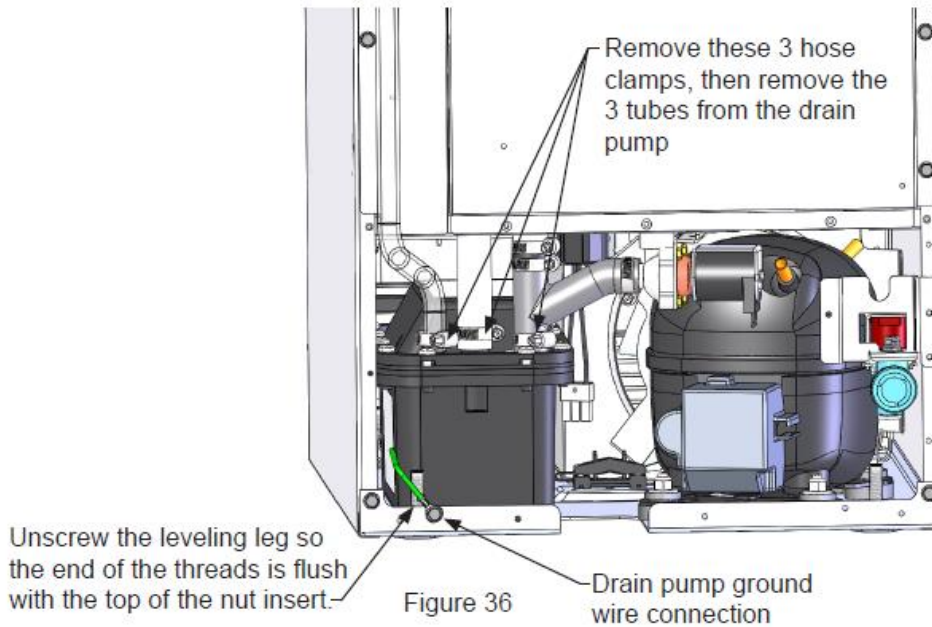

Figure 36

19.4.15.3 Additional Inspection Issues upon Replacement:

Additional issues to be inspected by the installer upon service replacement:

1. The drain pump must be level.
2. No pinched water lines.
3. No interference with electrical cords or wiring.
4. The drain pump should not set on any obstacles, wiring, etc.
5. Secure all hose clamps leading to and from the drain pump.
6. Insure that the vent tube height is adequate - 18 inch minimum.
7. Insure that drain height is adequate - maximum of 8 foot.
8. Insure that drain length is adequate - maximum of 20 foot.
9. Checked for water leaks after installation of the drain pump.
10. Check for vibrations caused by improper installation.
11. Insure that there is no interference with back access cover.
12. Insure that the hole grommets are in place at each location so that any vent or drain tubes do not rub on any sharp surfaces.

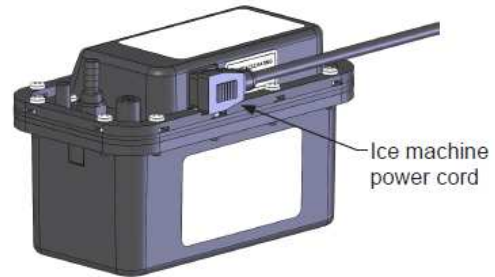

Figure 37

19.5: Diagnostic Test Modes

19.5.1 Power on Reset (POR) Auto Test Mode:

Every “power on reset” (POR) will initiate with an “auto self-test”. The user interface display will simulate normal operating conditions during the auto self-test.

This auto self-test mode will initiate at the beginning of the initial appliance start-up and after power is restored after every loss of power that might occur due to customer or supply voltage reasons. This function could result in a service call, so it’s possible that customer education could be applied.

During the POR auto self-test mode, the appliance will operate as follows:

- The display will show the last machine state.
- The interior lights will function normally.
- The “Lock” feature will function normally.
- The “ON/OFF” key works normally.
 - NOTE: if the appliance is turned “Off” during the POR self-test, the appliance will be disabled immediately.
- The “Delay Start” feature works normally.
 - NOTE: if “Delay Start” is selected during the POR self-test, the appliance will enter the selected delay start setting *after* the completion of the POR self-test.

19.5.2 Manual Auto Test Mode:

The manual auto test mode is activated manually by pressing and holding the “LOCK” key then pressing the “Delay Start” key (again still while manually pressing and holding the “Lock” key). The display will flash 5 times to indicate that the manual auto test mode has been enabled.

NOTE: The execution of the auto test sequence is identical in either the POR auto test or manual test mode.

19.5.3 Appliance Component Test Sequence while in Auto Test:

AUTO TEST MODE		
LOAD	ON	OFF (pause)
Condenser	0 – 15 sec.	16 – 17 sec.
Grid Cutter	18 – 33 sec.	34 – 35 sec.
Water Valve	36 – 51 sec.	52 – 53 sec.
Drain Valve	54 – 69 sec.	70 – 71 sec.
Circulation Pump	72 – 87 sec.	88 – 89 sec.
RGV	90 – 105 sec.	106 – 107 sec.
Compressor & Condenser.	108 – 245 sec.	
Compressor, Condenser & RGV.	245 – 380 sec.	381 sec.

This control operates on a timed cycle event. The control performs a “Power on Reset” test at the beginning of each power up event (initial startup, after loss of power, etc.). Each individual component is tested prior to the harvest cycle. The harvest cycle current timing is 5 minutes; production cycle is 45 minutes at a 55°F ambient. An additional 45 seconds are added for each degree the condenser outlet temperature rises over 55°F.

19.6: Diagnostic Charts

19.6.1 Operation Mode:

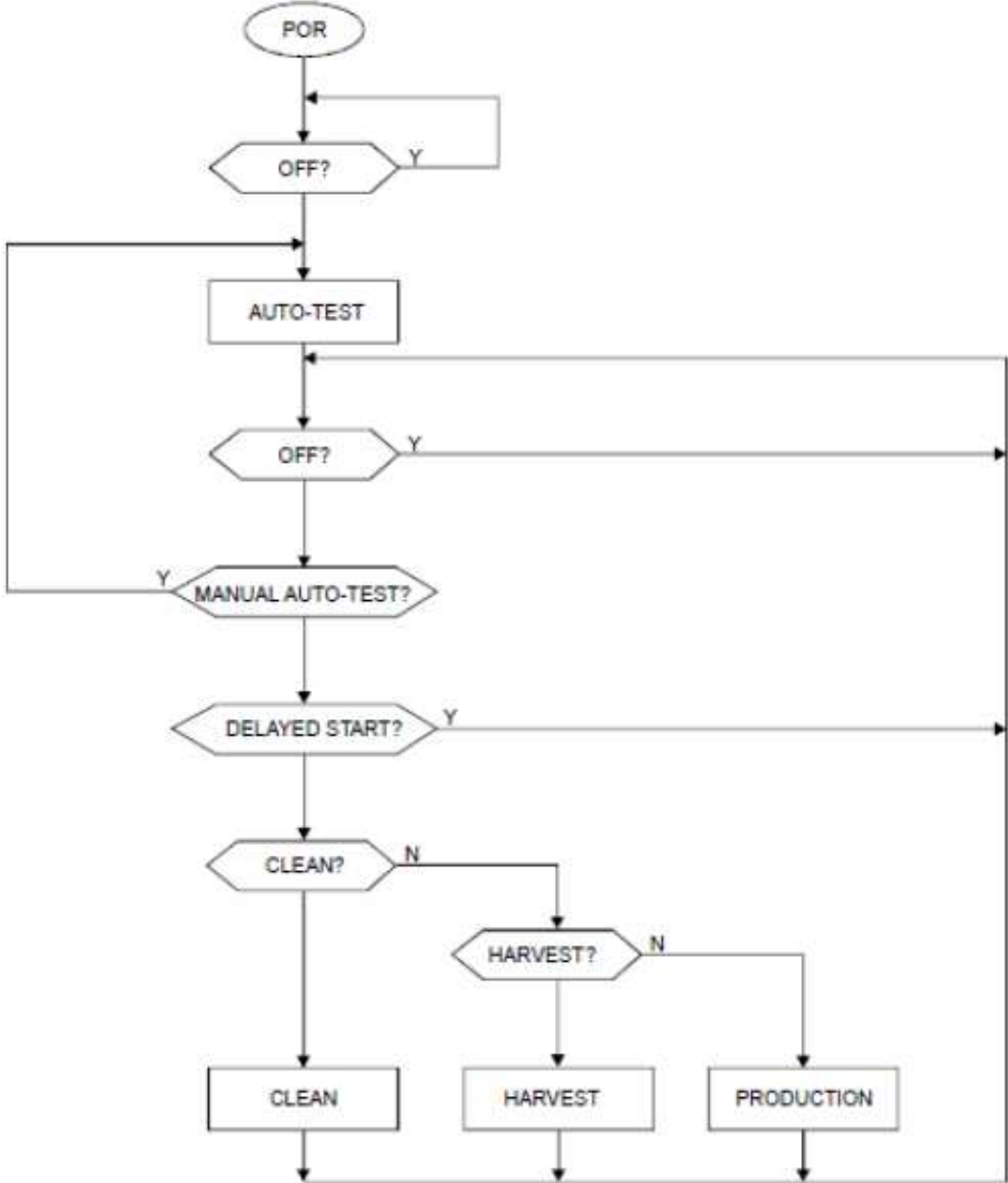

19.6.2 Harvest Mode:

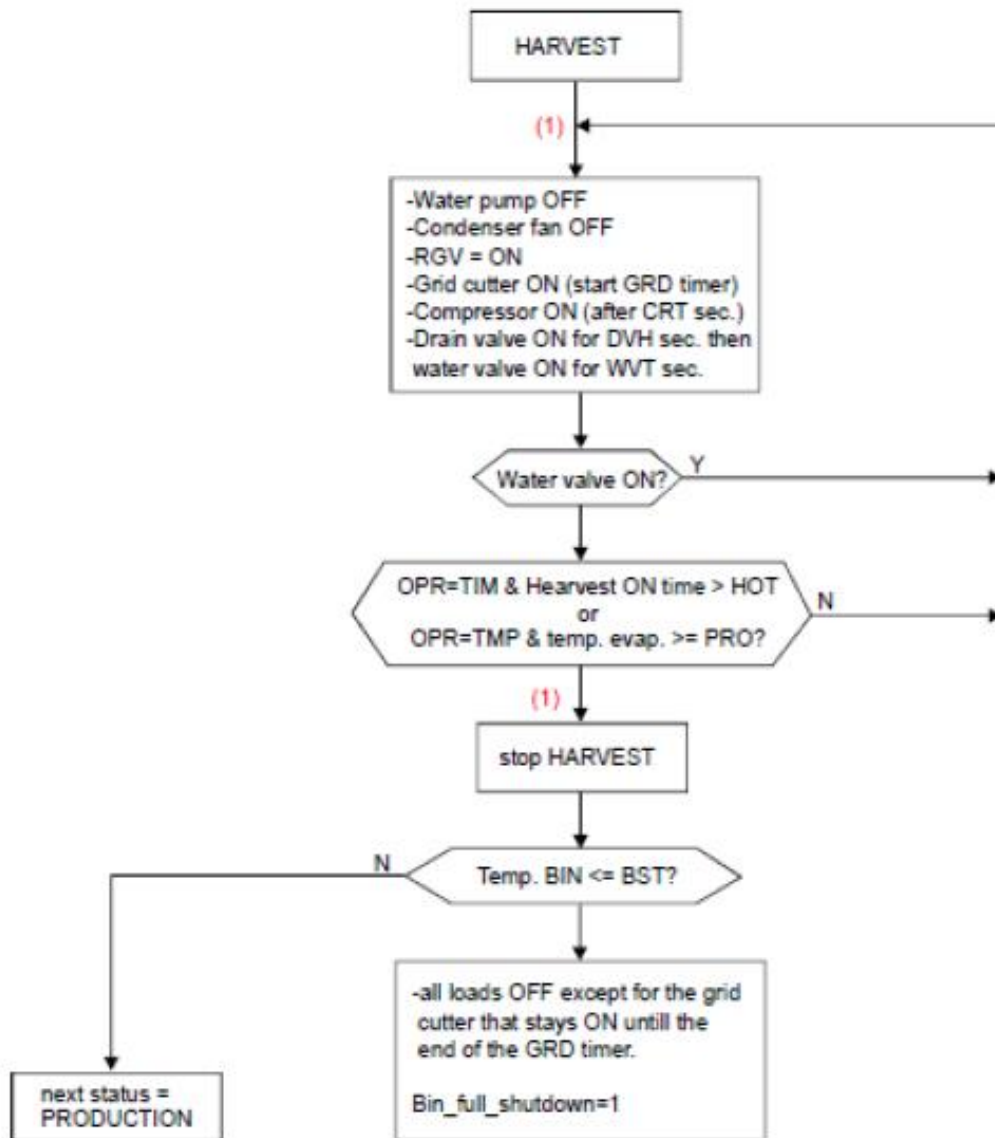

(1)
In SABBATH mode the harvest cycle starts and ends
with a random delay between 15 to 20 seconds.

19.6.3 Production Mode:

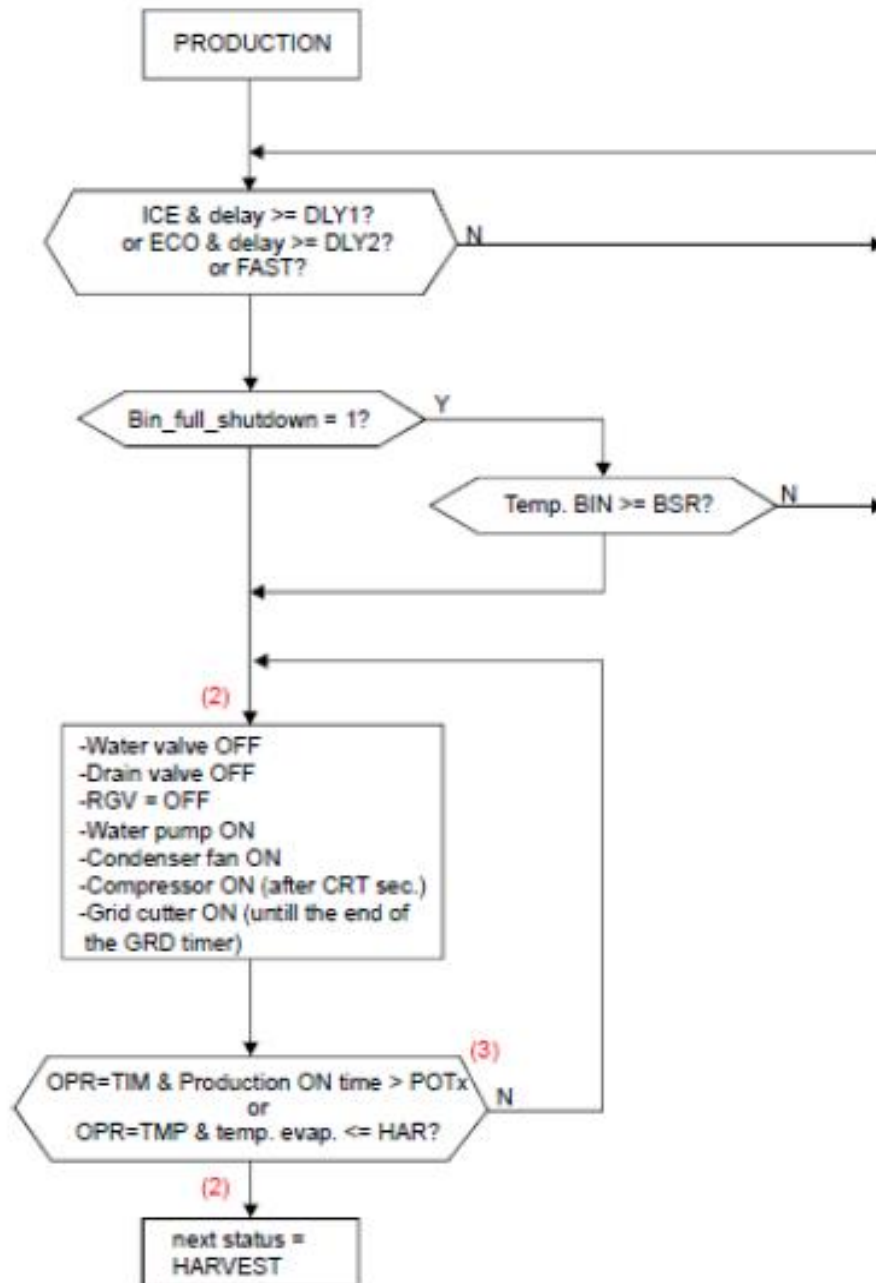

(2)
In SABBATH mode the production cycle starts and ends
with a random delay between 15 to 20 seconds.

(3)
if $T2 < 70^{\circ}\text{F}$ \rightarrow $POTx = POT$
if $70^{\circ}\text{F} \leq T2 \leq 110^{\circ}\text{F}$ \rightarrow $POTx = POT + PAC \cdot (T2 - 70^{\circ}\text{F})$
if $T2 > 110^{\circ}\text{F}$ \rightarrow $POTx = POT + PAC \cdot (110^{\circ}\text{F} - 70^{\circ}\text{F})$

$T2$ = ambient temp.

19.6.4 Clean Mode:

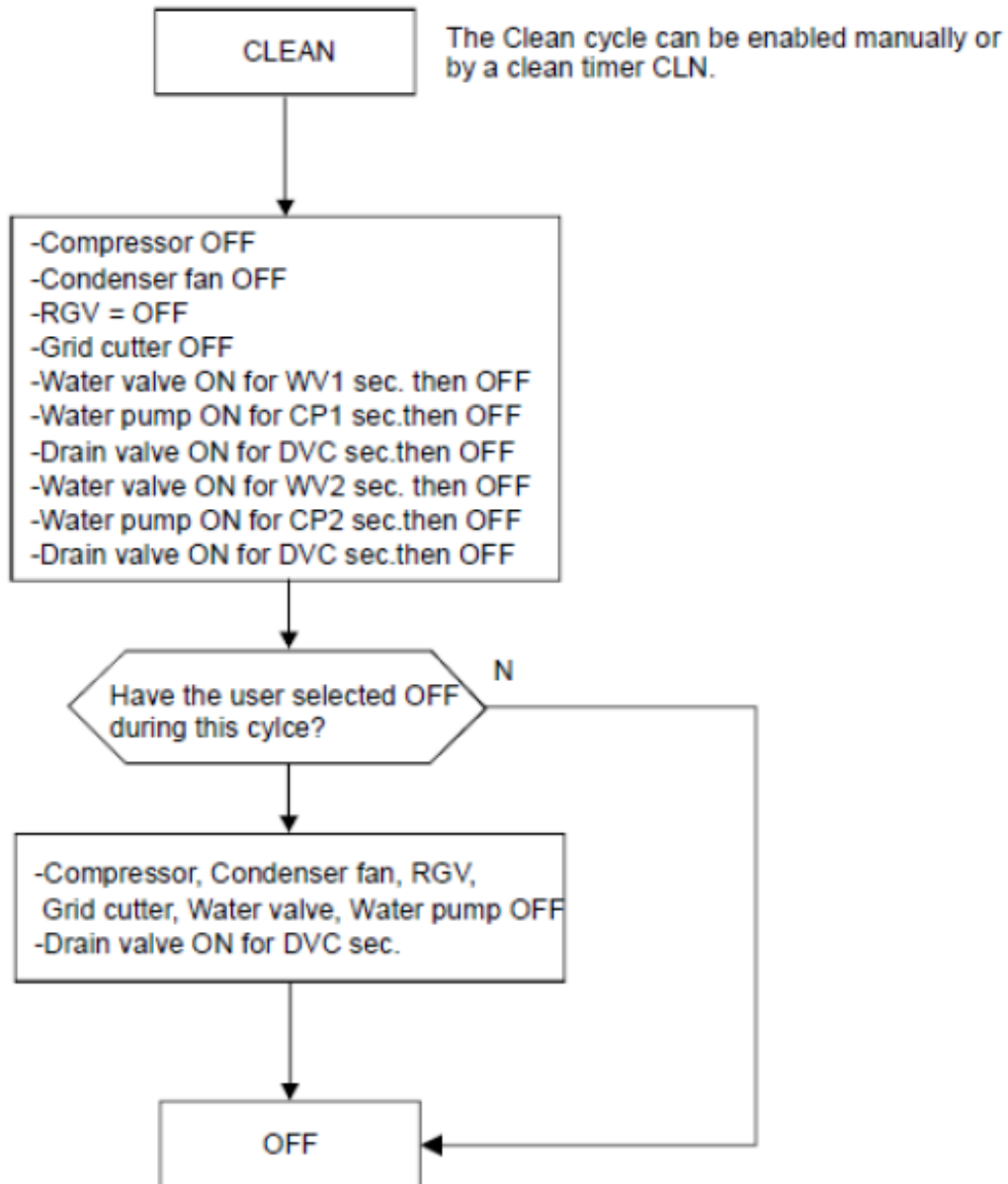

19.6.5 Production and Harvest Cycle Characteristics:

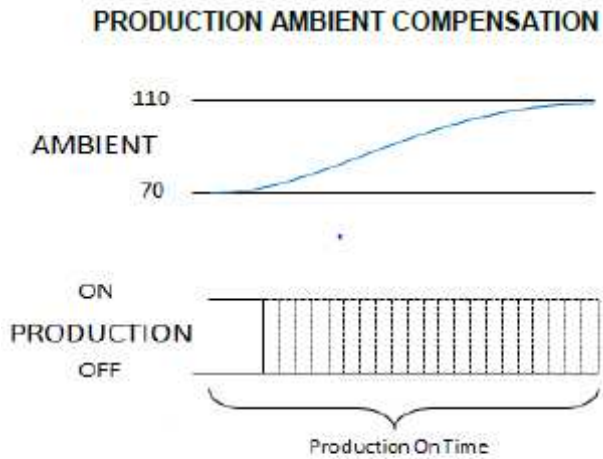
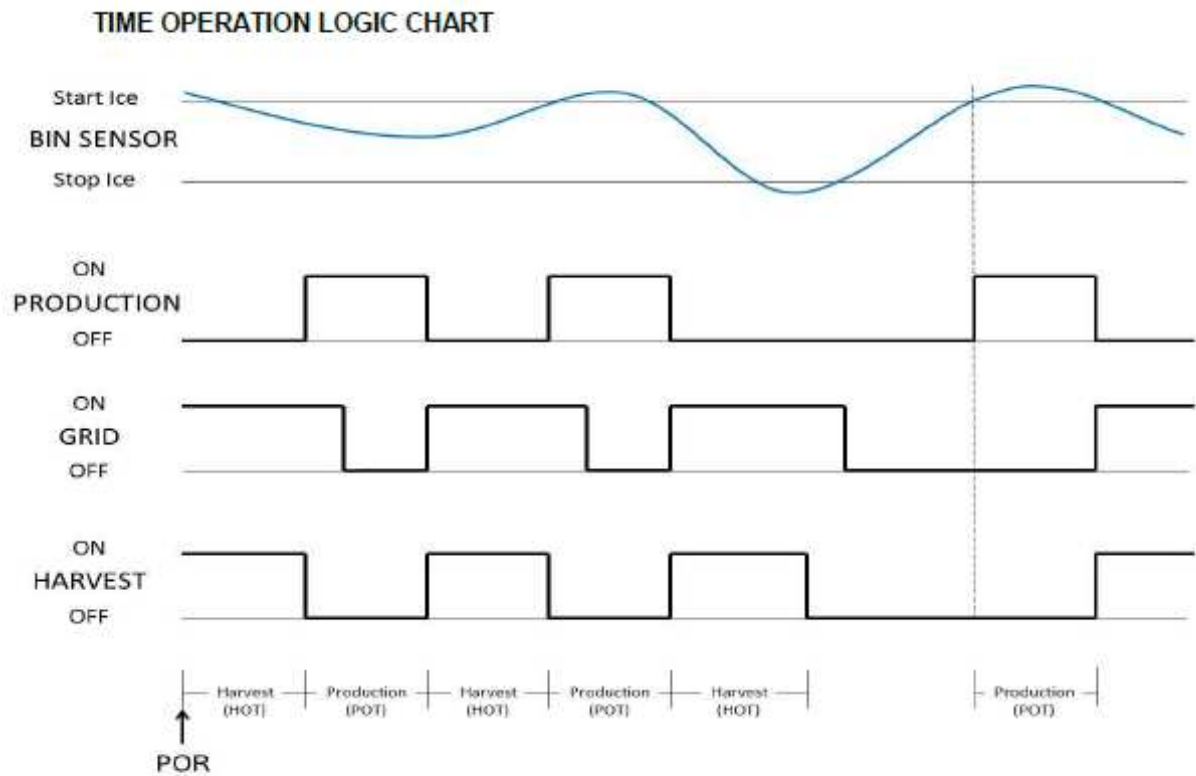

19.6.6 Clean Cycle:

Compressor, condenser fan and RGV are disabled for the duration of a CLEAN cycle.

Water valve ON for "WV1" seconds then OFF.
Circulation pump ON for "CP1" seconds then OFF.
Drain valve ON for "DVC" seconds.
Water valve ON for "WV2" seconds then OFF.
Circulation pump ON for "CP2" seconds then OFF.
Drain valve ON for "DVC" seconds.

All loads will remain off after a clean cycle. The User Interface displays OFF.
If OFF is selected during a clean cycle (press and hold ON/OFF key), all loads except the drain valve will be disabled. Only the drain solenoid will remain enabled for "DVC" seconds and then disabled. Machine remains in OFF state until the ON state is selected.

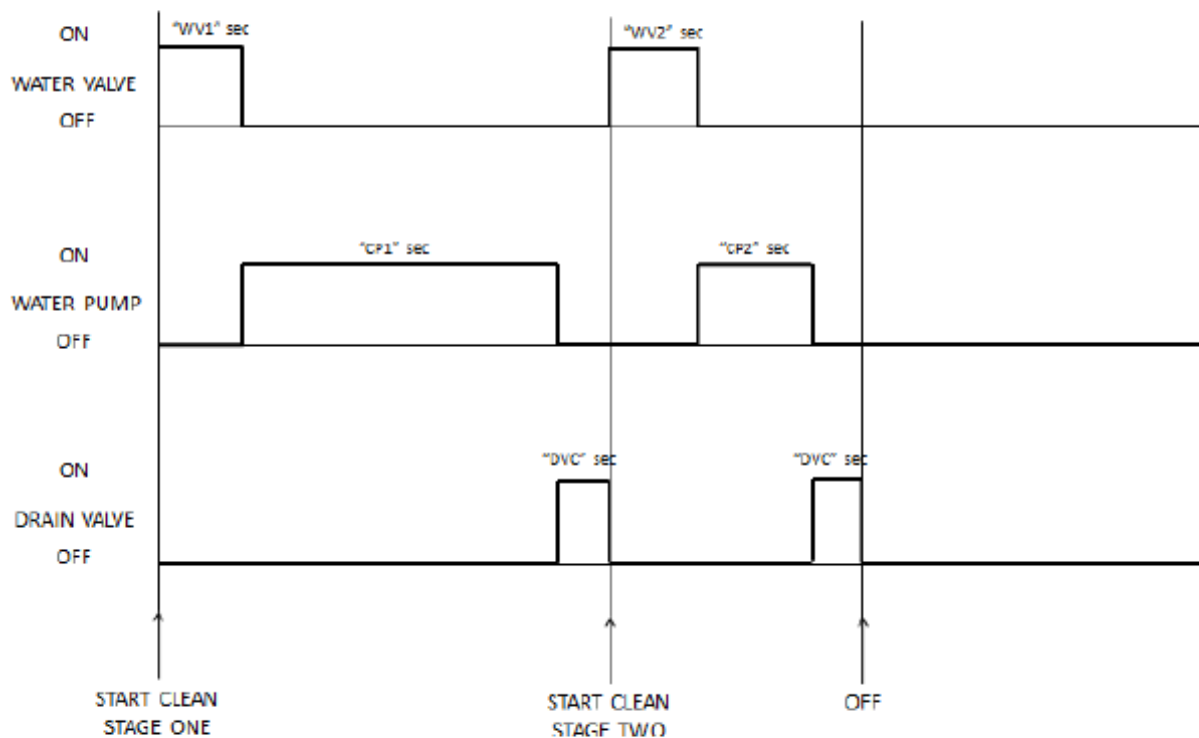

NOTE: It takes 26 weeks of total accumulated compressor run time to activate the next defrost period.

19.7: Trouble Shooting

19.7.1 Ice Machine Operation:

19.7.1.1 Ice Machine does not operate:

1. Is the machine power cord plugged in?
2. Is the electronic control showing the “ICE” position?
3. Is a fuse blown or breaker tripped?
4. Is the room temperature cooler than normal?
 - a. Minimum room temperature for an ice machine to operate efficiently is 55°F (13°C). The bin sensor may sense a full bin condition and prevent the ice machine from going into a production mode.
5. Does the appliance have a drain pump?
 - a. The drain pump may be removing water from the system.

19.7.1.2 Ice Machine is noisy:

1. Can water be heard circulating in the ice machine?
2. Customer education is a possibility: The process of making ice involves a refrigeration cycle, water circulation and a combination of solenoids, valves, and motors. It is not a quiet procedure.

19.7.2 Ice Production:

19.7.2.1 Little or no ice:

1. Is the control set to the “Ice” position?
2. Is the supply water present at the fill valve?
3. How long has the ice machine been running?
 - a. A typical production cycle can take up to 1 ½ hours. Start time is typically longer at the initial start-up. After 24 hours, the bin should be near capacity without any consumption.
4. Is the water reservoir drain plug in place?
5. Is water flowing out of the water distribution tube?
6. Is the condenser fan operating without restrictions in the air flow?
7. Is the room or water temperature too warm?
 - a. Maximum ice capacity is achieved in an ambient less than 90°F (32°C). It is also recommended that the ice machine not be placed in direct sunlight, next to a stove, range, space heater, hot air registers, hot water radiators, or any other type of direct heating source. Excessive heat will deter ice production and storage.
 - b. It is important to realize that the ice bin is not a refrigerated compartment. Cooling for ice storage is essentially created by the ice itself.
8. Is there scale built up in the ice machine?
 - a. Initiate a clean cycle with a recommended nickel-free cleaner.

19.7.3 Ice Quality:

19.7.3.1 Odor, greyish color, or off- tasting

1. Check for mineral scale build up on the evaporator plate.
 - a. Initiate a clean cycle with a recommended nickel-free cleaner.
2. Does the supply water have a high mineral content?
 - a. Installation of a water filter in the supply line is recommended.
3. Are any food types (or items) stored in the ice bin?
 - a. If so remove them.

19.7.3.2 Ice Clumps

1. Look for clumps of ice in the bin.
 - a. Ice machines with low consumption rates tend to have “fused” or clumped ice. This is caused by water refreezing and fusing cubes together.
 - b. In severe cases, the ice will become stale and frosty in appearance.

19.7.3.3 Small Cubes

1. How often is ice being consumed?
 - a. As mentioned above, low consumption rates affect ice quality. Unused ice will melt while inside the storage bin. This is often more noticeable when the bin is less than ¼ capacity.
2. Is the water supply adequate? Look for a restricted supply filter.
3. Look for loss of water in the reservoir. Is the drain or drain valve seeping?
4. Is the water distribution tube restricted?
 - a. Initiate a clean cycle with a recommended nickel-free cleaner.

19.7.4 Plumbing Issues:

1. Is the drain hose aligned properly with the drain?
2. Is the ice machine draining properly?
 - a. Avoid kinks and restrictions in the drain line.
 - b. Check for foreign objects blocking the inside of the drain system (inside and outside the machine).
 - c. Ensure that the drain pump is installed level.
 - d. **NOTE: It is recommended that external plumbing issues should be address by a licensed plumber.**

19.7.5 Drain Pump Troubleshooting:

19.7.5.1 Check the following if the ice machine isn't working

- Make sure there is voltage at the receptacle.
- Make sure the ice machine is turned “On”.
- Make sure the ice bin is not full.
- Confirm the operating status of the drain pump.

- Supply voltage to the ice machine will be interrupted if the drain pump becomes full.

19.7.6 The Drain Pump is Inoperative:

1. Verify that the power cord is connected at the pump (2 locations) and the main power board.
2. Look for possible restrictions in drain lines.
3. Ensure that the vent line is clear and able to breathe.
4. Not enough water to turn pump on.
 - a. At least 1 quart (.95 liters) of water is needed to activate the pump.

19.7.7 The Drain Pump runs but not pumping:

1. Look for possible restrictions in drain lines.
2. Ensure that the vent line is clear and able to breathe.
3. Check to see if the drain line is to specifications.
 - a. Maximum lift is 8 feet (2.44 meters).
 - b. Maximum run is not greater than 20 feet (6.1 meters).

19.7.8 The Drain Pump runs momentarily and shuts off:

1. Ensure that the drain and vent lines are free and unrestricted.
2. Verify that the drain pump is level.
3. Look for loose voltage connections; inspect the power cord where it is connected at the pump (2 locations) and the main power board.

19.7.9 Thermistor (Sensor) Error Detection:

Temperature thermistors are monitored continuously by the main power board. Any “OPEN, SHORTED, or OUT of RANGE” thermistor circuit will initiate an alarm.

If an error is detected, the ice machine will immediately shut down and the display interface will flash the corresponding fault code continuously. No audible alarm will sound.

19.7.10 Communication Error:

Loss of communication between the main power board and the user interface will result in either a continually flashing “ON” or “OFF” on the display.

19.8: VAC Wiring Diagram and Schematics

19.8.1 Block Diagram of Main Power Board:

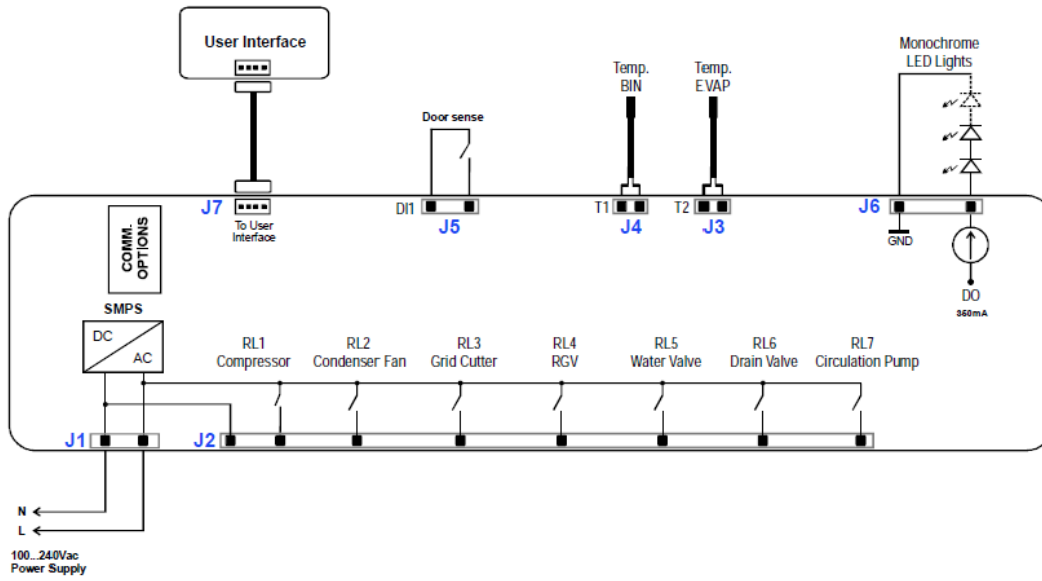

19.8.2 Wiring Diagram:

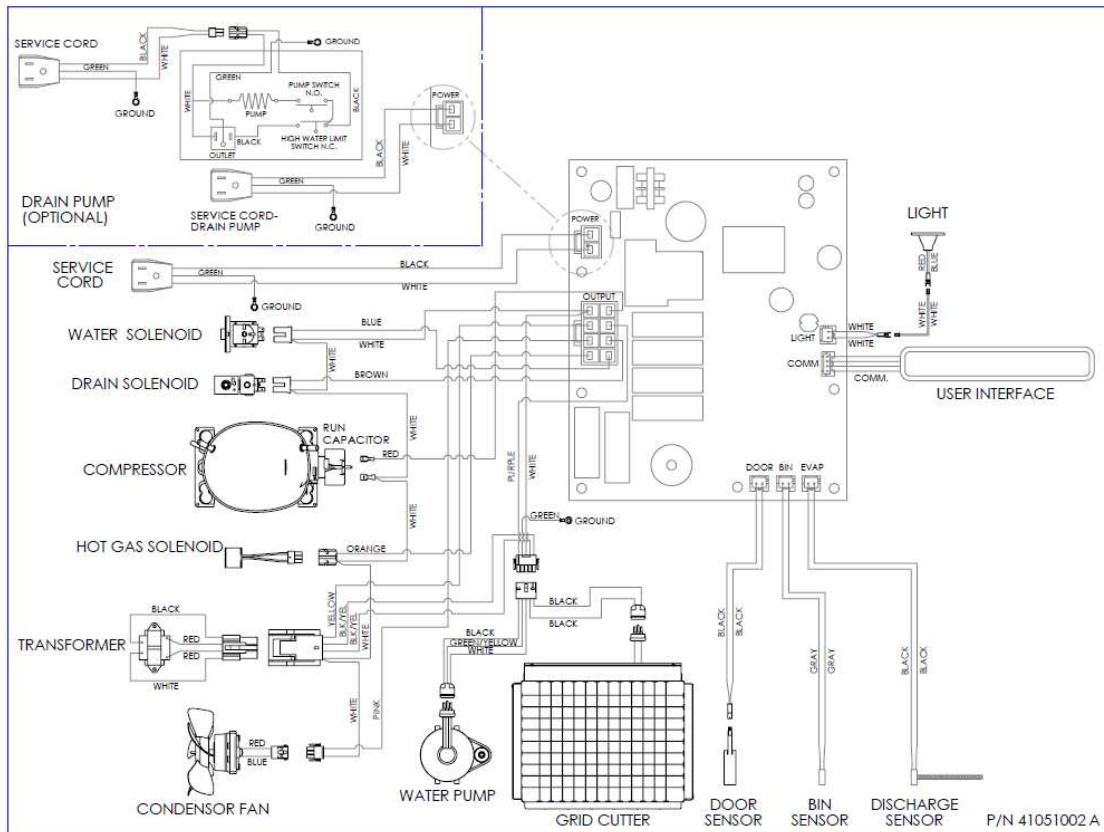

19.8.3 Main Power Board Identification:

USER INTERFACE ASSEMBLY

ICON/Key Switch Assembly

UI Carrier

UI PCA

UI Receiver (foamed in)

MAIN CONTROL ASSEMBLY

1 – Compressor / Condenser Fan output – 115VAC-230VAC

1 – Grid Cutter Output – 115VAC-230VAC.

1 – Circulation Pump – 115VAC – 230VAC.

1 – RGV (or Electric Harvest) Output – 115VAC-230VAC.

1 – Drain Valve Output – 115VAC-230VAC.

1 – Water Valve Output – 115VAC-230VAC.

1 - 12VDC LED Theater Lighting channel (up to three lights).

1 – Door Sensor Input.

Designed to accept Data Port 41050465 or RF Port 41050466.

International Power Supply (100 – 240VAC +/-10% 50-60 Hz)

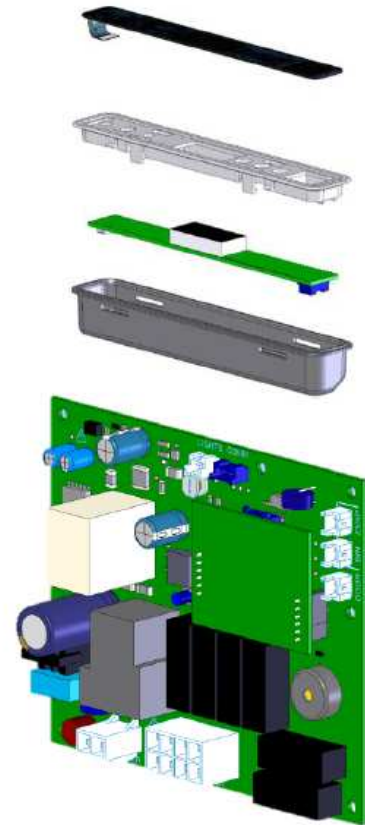

19.9: Specifications:

19.9.1 Ice Machine Components:

19.9.1.1 Output Loads (120V/60Hz)

Compressor:	Embraco EMY70
Condenser:	Panasonic FDQR107S2LNM
Transformer:	Basler 120V, 0.24A / 12V, 25VA
Water Valve:	Horton S30 120V, 12W
Drain Valve:	Horton S90 120V
Circulation Pump:	Beckett 120V, 220mA
LED Lights:	12VDC, 350mA, constant current LED driver

19.9.1.2 Input Loads

Bin Temperature Sensor (thermistor):	NTC/ 10K@25C
High Side Temperature Sensor (thermistor):	NTC/10K@25C

19.9.2 Ice Machine Specifications:

Voltage:	120 VDC
Frequency:	60 Hertz
Amperage:	3.0 Amps Start 1.73 Amps Running
Wattage:	121 Watts
Compressor:	450 BTU's
Condenser Fan Motor:	4.1 Watts 0.7 Amps
Refrigerant Charge:	5.0 oz.
System Pressures (Stabilized):	178 PSI High Side 25 PSI Low Side
Cabinet Dimensions	Width: 14.88" Height: 33.75-34.75" Depth: 23.62"

19.10: Production and Harvest Guidelines

19.10.1 Harvest Cycle:

1. During “*Harvest*” time; the circulation pump and condenser fan outputs are disabled.
2. The compressor, hot gas, and drain valves are enabled.
3. The drain valve will remain enabled for 60 seconds before becoming disabled.
4. The fill valve will be enabled for 150 seconds before becoming disabled.
5. The compressor remains enabled.
6. All loads will remain in this state until the end of the harvest time (beginning of next production time).
7. All harvest events will enable the grid cutter.

19.10.2 Production Cycle:

1. During the “*Production*” time; the circulation pump, condenser fan, and compressor are enabled.
2. The fill valve and the drain valves are disabled.

19.10.3 Timed Operation for Harvest and Production:

1. The high side thermistor senses the temperature of the liquid line at the filter drier inlet.
2. If the bin thermistor senses a temperature at or below the “**Stop Ice**” set point, any occurring *production* or *harvest* cycle will continue until the conclusion of the current *harvest* (if already in harvest) or the following *harvest* (if currently in production). Once either condition is met, the machine will go into the “**Stop Ice**” mode. Once this occurs all loads will be disabled except for the grid cutter (35 minutes only). All loads will remain disabled until the call for the next “**Start Ice**” set point is reached.
3. During a *harvest* event, a *production* event cannot start until the fill valve solenoid (while in the *harvest* mode) completes its fill cycle.
4. The grid gutter enables at the beginning of a *harvest* event.
5. If “**Clean**” is selected on the user interface display, any *production* or *harvest* event will immediately terminate and the clean event will begin.
6. If “**Off**” is selected on the user interface display, the event in progress will be stopped and all loads disabled.
7. A “**Power on Reset (POR)**” will initiate a compressor reset time (compressor inoperative).

19.10.4 Ambient Temperature Compensation:

A high ambient temperature or restricted condenser air flow will have a negative effect on ice production. The high side thermistor placed on the liquid line directly reacts to changes in system temperatures due to changing ambient conditions. To compensate, the main power board is programmed to add or subtract to the *production* time for every 1°F ambient temperature change sensed at the condenser location.

Section 20: Service Kits/Bulletins

20.1: Service Bulletin # 41013862 Mullion Condensation on Refrigerated Drawers

Mullion Heater Kits - Installation Instructions:

Part numbers: S42413105-BLK for Marvel models and S42418081-BLK for Marvel Professional models (with lock).



CAUTION:

The appliance must be disconnected from its power source prior to performing this repair.



Mullion Heater Kit components:
See page 107 for component details.

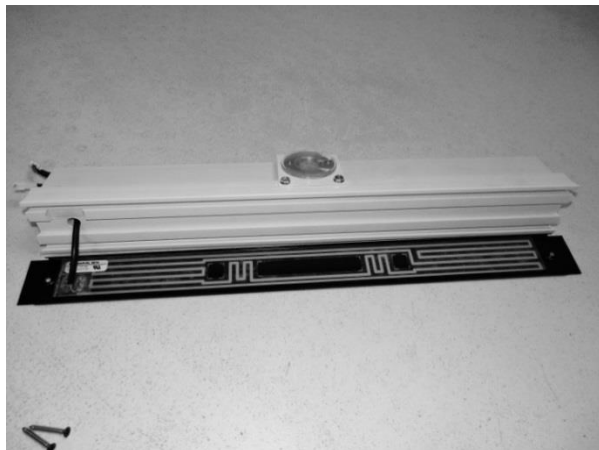

Note the adhesive heater on rear of painted mullion panel.

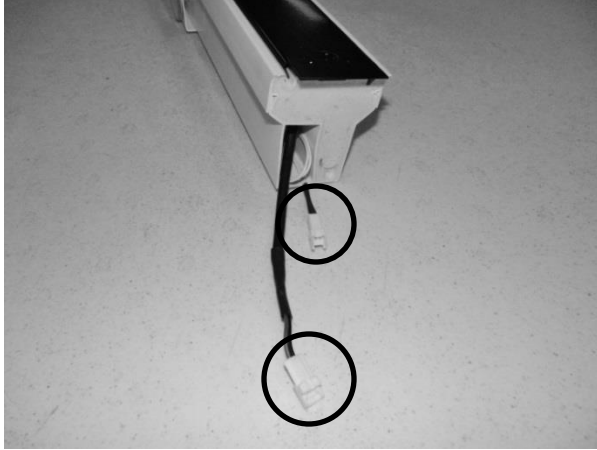

LED light and mullion heater harness connections.

Accessing the Mullion

- **Remove the Drawers (See Section 7.3)**
- **Remove the Mullion as follows:**



Remove the two top sheet metal screws securing the right hand mullion bracket to the cabinet. Loosen the rear screw. The mullion bracket will stay with the mullion when it is removed.



Remove the sheet metal screws on the top and bottom of the left hand mullion bracket. The mullion bracket will stay attached to the cabinet.



Pull mullion carefully away from cabinet. Disconnect the LED light connector (white wires extended from mullion to the cabinet liner).

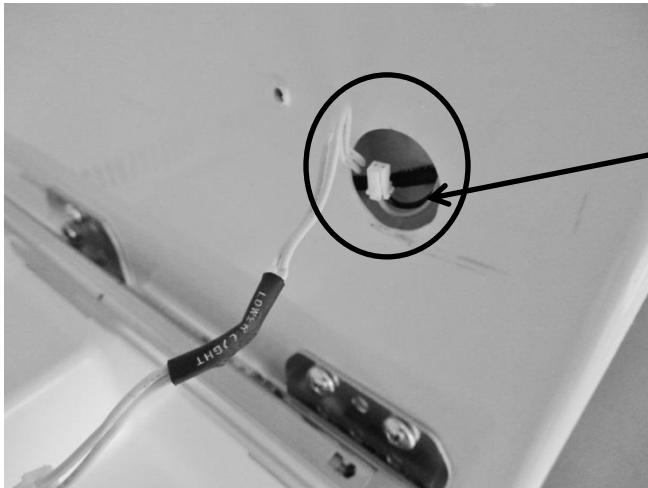

Pull the yellow and black mullion heater wire out from inside the cabinet liner.



Prior to installing the new mullion assembly, center the black painted strip over the plastic mullion. Use a piece of tape on each end to temporarily hold the assembly together.



Attach the right hand mounting bracket to the new mullion assembly.



Connect both the light and heater wires from the mullion assembly to the wires leading from the cabinet.

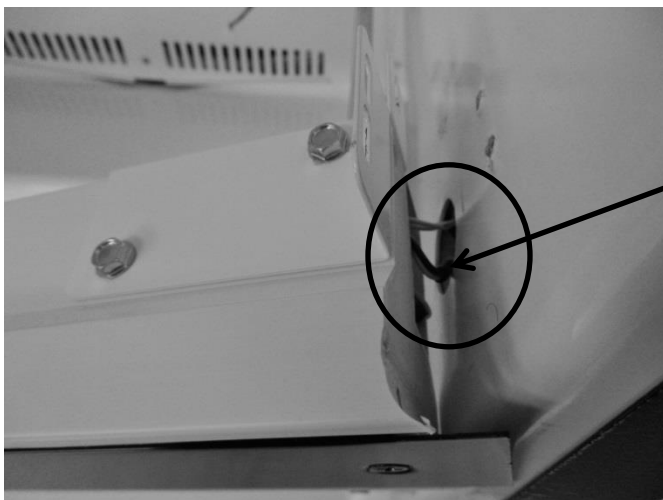

Feed the remaining light and heater harnesses into the mullion assembly.



Carefully align both ends of the assembly with the cabinet bracket locations. This will fit firm. Take care not to pinch the LED and heater wire harness, press both ends of the assembly into place.



Replace all screws on each end of the bracket and cabinet.



Secure the mullion assembly using the black head screws. Use one screw on each end of mullion, the screw will self-tap into the assembly.

Accessing the Machine Compartment

- Remove the lower back access panel (See Section 3.3)
- Disassemble the following components as noted.



Locate and remove the Phillip's head screw which secures the control board bracket to the cabinet frame.

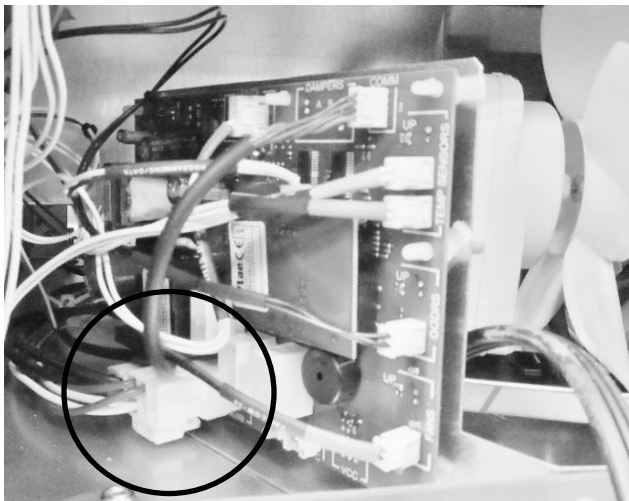

Disconnect the power connector at the bottom, left rear of the control board. See below photo for reference.

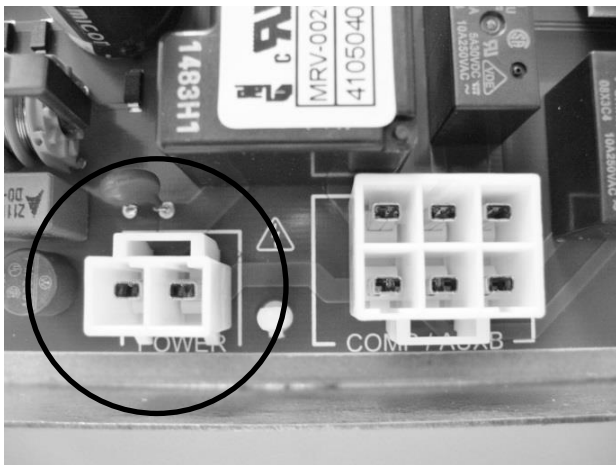

FOR REFERENCE: Top View of power connector on main board.

Kit Components

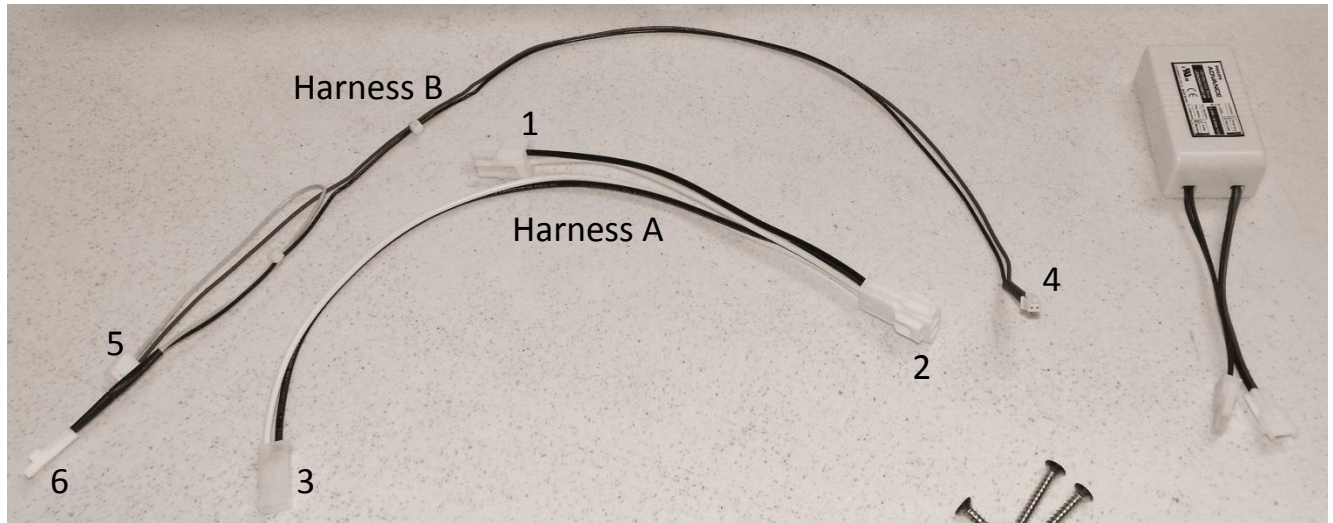

Harness A

- Connector 1 (Black and White Wires)
- Connector 2 (Black and White Wires)
- Connector 3 (Black and White Wires)

Harness B

- Connector 4 (Red and Black) power supply
- Connector 5 (Yellow and Red)
- Connector 6 (Black and Yellow) mullion heater

Installing the wiring harness

NOTE: Use the photo on page 8 to reference wire harness and connectors below.

NOTE: See the following photos for reference.

Wiring Harness A

1. Locate and remove the Phillip's head screw which secures the main power board mounting bracket to the cabinet frame.
2. Remove the power connector at the bottom, left rear of the main power board (see above photo).
3. Plug connector "1" on harness A into the POWER terminal on the main power board.
4. Attach the original connector previously removed from the POWER terminal to connector "2" on harness A.
5. Plug the remaining connector "3" into the adjoining terminal on the power supply from the kit.

Wiring Harness B

1. Locate connector "4" on harness B. The wire will be identified as "Power Supply". Plug this connector into the remaining terminal on the power supply from the kit.
2. Locate the yellow and black harness extending through the upper, left hand corner of the machine compartment. The connector will be marked as "Mullion Heater". The wire will be coiled and unplugged as seen in picture above.
3. Plug the coiled connector (step 2) into the matching yellow and black wire on harness B, connector "6". It is also marked as "Mullion Heater".
4. The remaining connector "5" will be plugged into the "Aux C" terminal on the main power board.
5. At this time, the paper can be peeled off the adhesive tape on the bottom of the power supply. With the power supply in one hand, reach between the main power board and the condenser fan and place the power supply in a position where it will be out of the way. Press down on the power supply to adhere into place. The wires can be routed over the top of the main power board.
6. Place the main power board mounting bracket back into position. Confirm that the rear slot on the mounting bracket is secured by the positioning tab on the bottom of the machine compartment. Take care not to pinch any wires during this step.
7. The main power board mounting bracket can now be re-secured to the cabinet frame using the Phillip's screw.
8. If necessary the wires can be secured together with a nylon wire tie.

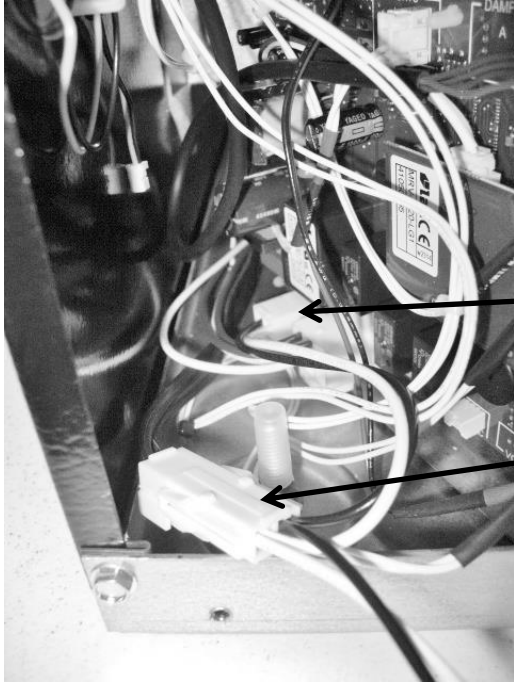

View of wiring harness A with connectors "1" and "2"

Connector "1"

Connector "2"

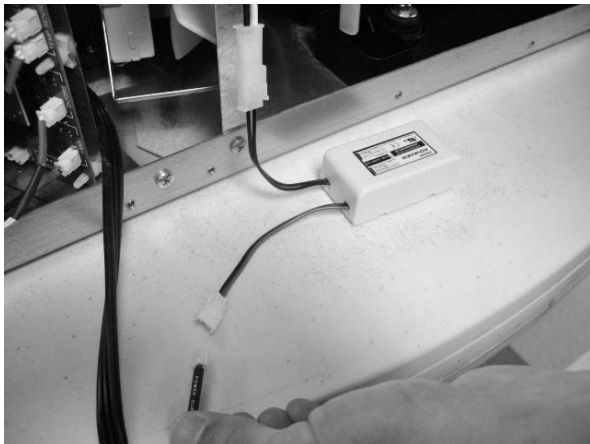

Connect the black and white wires from connector 3 (harness A) and the black and red wires from connector 4 (harness B) to the appropriate terminals on the power supply.



Place the power supply between the main power board and condenser fan as far forward as possible.

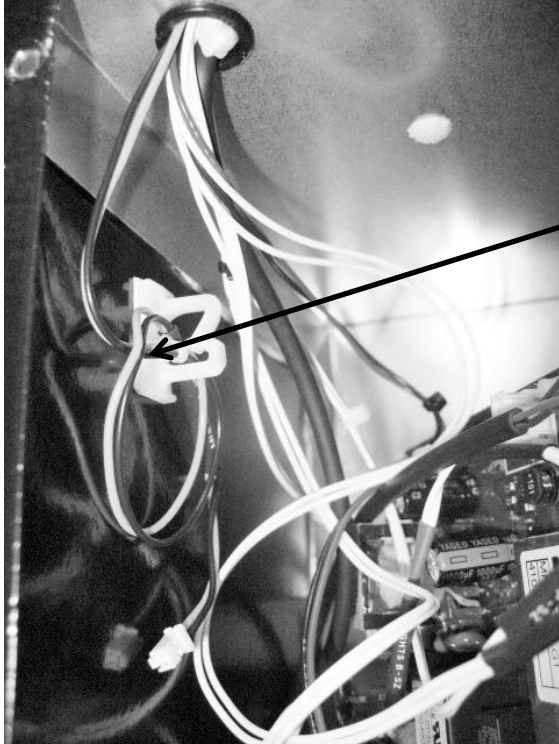

Note the location of the black and yellow mullion heater harness in the machine compartment.

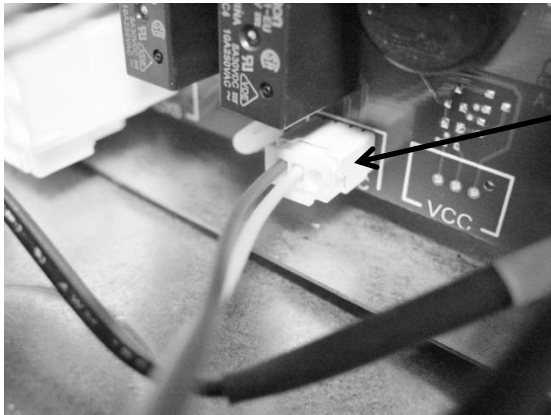

The red and yellow wires at connector 5 (harness B) will plug into the "Aux C" terminal on the main power board.

The rear panel and drawers can now be replaced. The unit can now be reinstalled back into position and voltage reconnected to the unit. The mullion heater is active 100% of the time.

20.2: SERVICE BULLETIN # 41013861 EVAPORATOR REPLACEMENT KIT*

***THIS KIT DOES NOT FIT THE RF / RFI MODELS, SEE THAT BULLETIN LATER
IN THIS SECTION**

Part number: 42249115, Evaporator Kit with Installation Instructions

REFER TO SECTION 3.6 FOR ADDITIONAL DISASSEMBLY INFORMATION

Reclaim Refrigerant from Sealed System

- **Reclaim the refrigerant in the sealed system per EPA regulations**

Evaporator Removal

The evaporator heat exchanger is foamed in place in the back cabinet wall.

1. Cut the heat exchanger at the point it enters the foamed cabinet (behind evaporator plate).
2. The suction line will also have to be cut at the point where it enters the foamed cabinet from the machine compartment.
3. Remove the white foam evaporator spacers. Save as they will be used for the new evaporator assembly.
4. Remove the evaporator and discard, caution of sharp edges from the cut tubing.
5. Unsolder suction line from compressor and discard, again use caution of sharp edges surrounding cut heat exchanger.
6. Unsolder the liquid and capillary lines from the filter drier.
7. Drill a ½" hole in the left hand corner of the drain sump as close to the side wall as possible. The hole must extend into the machine compartment.
8. Remove any sharp burrs on the top of the machine compartment created by the drill bit.

Top of machine compartment

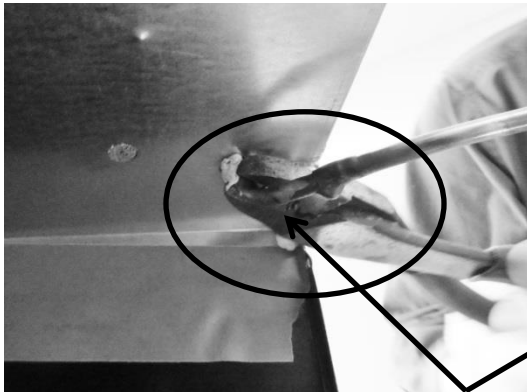

Interior back wall

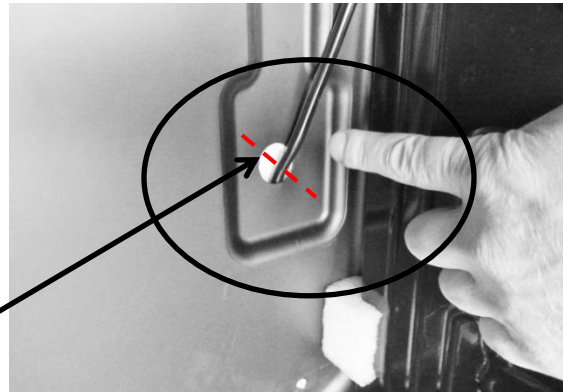

Cut away suction line at the above locations.



Drill a ½" hole downward into machine compartment.



Extend new assembly through the hole. Make sure ends are capped.

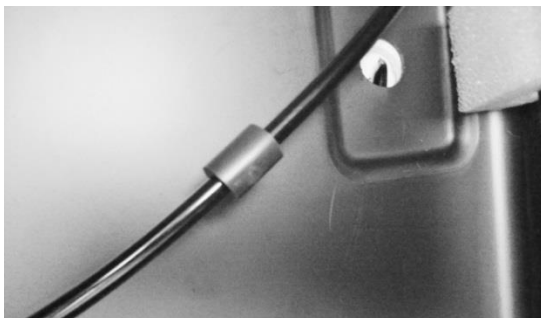

Install vibration isolator on heat exchanger assembly behind evaporator.



Size and cut the suction tube extension to connect the compressor to the suction line.

Evaporator Installation

A replacement evaporator assembly (42249115) will include the following components:

- (1) Evaporator heat exchanger assembly
 - (1) Filter drier
 - (1) Pre bent suction tube extension
 - (1) Vibration isolator
 - (2) Nylon zip tie fasteners
 - (2) Pieces of permagum
1. Take the replacement evaporator and unroll the capillary tube on the heat exchanger.
 2. Absolutely make sure that the ends of the capillary tube and suction line are well capped. Wrap both ends with tape to insure that no foam enters the tubing when passing through the ½" drilled hole. Any foam that is allowed in the tubing will compromise the sealed system.
 3. Once the new evaporator is in place, the suction line in the machine compartment will have to be bent (thumbs and forefingers) at an angle towards the compressor.
 4. Carefully recoil the capillary tube.
 5. Install a new filter drier and solder the capillary and liquid line in place.
 6. The kit will include a section of pre-bent suction line. The bent end will be soldered into the compressor.
 7. Use a 3/8" swedging tool to expand the opposite end of the suction extension. This will fit over the new suction line extending into the machine compartment. This connection can now be soldered.
 8. The kit also includes a rubber vibration isolator, place this onto the heat exchanger behind the evaporator to protect against tube rattles between the evaporator and cabinet liner.
 9. Replace the defrost thermistor and attach with the two zip lock fasteners in the kit.
 10. Place one piece of permagum around the newly drilled hole for the suction line assembly inside the interior of the cabinet. Make sure that it is worked into and around the hole to seal off any moisture or heat.
 11. Use the second piece of permagum and also work that into and around the hole in the machine compartment where the new suction line assembly exits the liner.
 12. Re-install the white foam spacers. The spacers have an off center cut on one side, place the fat side of the spacer (with the thickest foam) towards the back wall of the liner.
 13. Reassemble the coil cover and interior components in reverse order as removed.
 14. Prior to reassembling the machine compartment, a thorough leak check should be performed to verify that all joints have been soldered or brazed correctly.
 15. Proceed to pull a minimum 50 Micro vacuum.
 16. Recharge system with weighted charge per specification on serial plate.
 17. Leak check.

20.3: SERVICE BULLETIN # 41013995 Rev C Contact between the Door and Door Sensor

Complaint: An audible door alarm sounds every 60 seconds and “Door Ajar” will continually flash on the User Interface display pad.

Diagnosis: The door sensor and / or spacer are not closing the alarm circuit. Both components should be replaced.

Models Impacted: Most ML and MP models built within the serial number range listed below. *Ice Machines (no door sensor) and Refrigerated Drawers are exempt. Drawer models use a rocker style door switch.*

Serial Number Range: ML and MP (Ice machines and Drawer Models not included) models built prior to 20150109008H.

Repair: Service Kits:

- S41050470-ss (stainless)
- S41050470-wht (white)
- S41050470-blk (black)

Service Kit:



PARTS INCLUDED:

- Door sensor
- Door spacer
- Alcohol wipes (2)
- Installation Instructions

This service kit includes the following components:

- Door sensor
- Door sensor spacer
- Alcohol wipes (2)
- Assembly Instructions 41013996-ins

These instructions consist of 5 steps. Please follow all steps in sequence.

- Door sensor removal
- Door sensor location
- Door sensor replacement
- Door spacer location
- Door spacer replacement

The Door Sensor

The door sensor is located on the bottom cabinet flange; approximately 5 ¼” away from the inside flange of the cabinet; on the handle side of the cabinet (Exact measurement location attached). ***The Refrigerated Drawers do not use this technology, dual rocker switches are used for drawer models.***

The door sensor is resistance activated by the pressure from the door gasket. Light functionality and the door alarm are directly related to this switch.

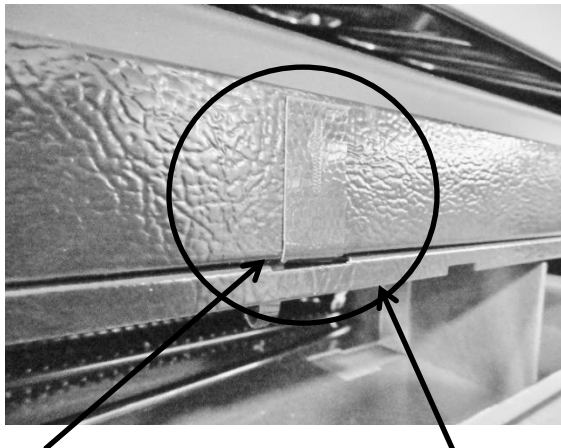

Door Sensor location

Cabinet trim

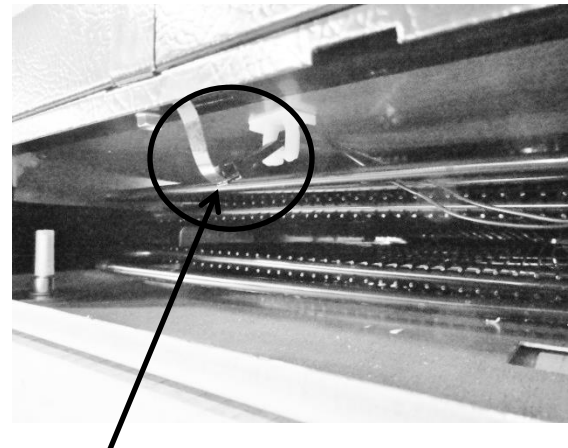

Sensor disconnect terminal

Door Sensor Removal

1. Remove the toe grill.
2. Disconnect the door sensor at the harness terminal behind the trim piece. See photo on page 1.
3. Remove the door sensor from the cabinet by starting in one of the upper corners and peeling in a downward motion.
4. Once the sensor has been removed from the flange area:
 - a. Grasp the sensor with the right hand using the thumb and forefinger.
 - b. Grasp the electrical strip portion of the sensor between the thumb and forefinger on the right hand.
5. Slowly work the sensor through the gap on the lower trim section to remove. The upper portion of the electrical strip has some adhesive backing so care is advised.



Peel away from cabinet flange



Sensor removed

Prior to proceeding with the next step, please refer to the following pages on proper placement for both the door sensor and the door spacer.

Door Sensor Location

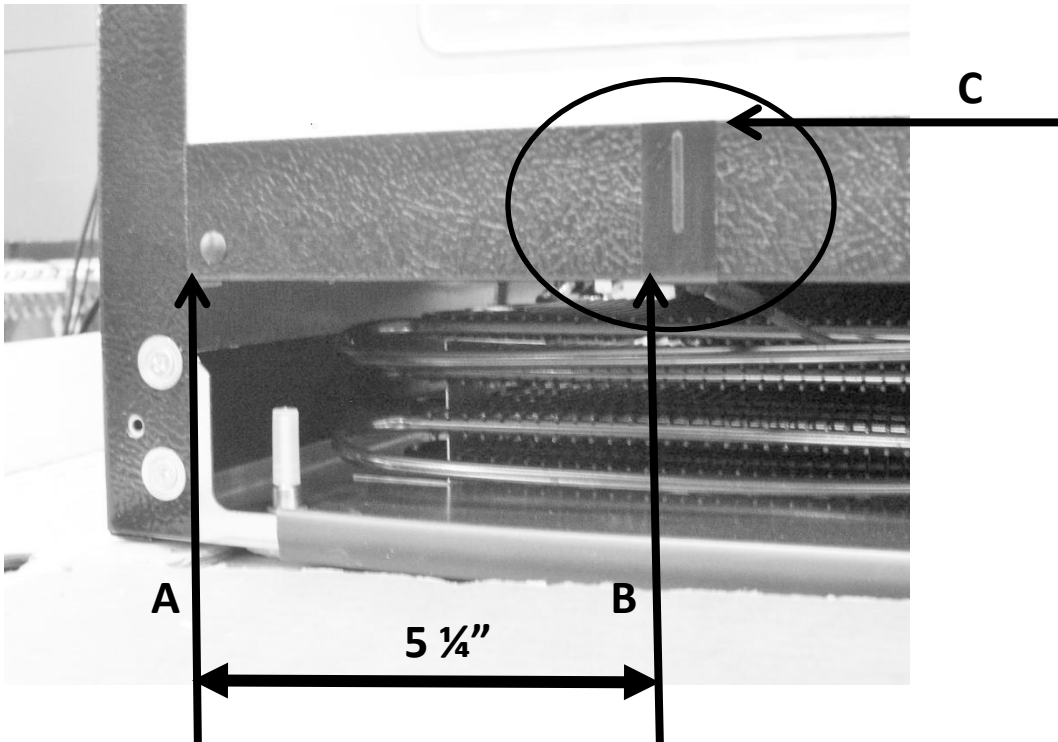

ALWAYS LOCATE AND POSITION THE SENSOR FROM THE HANDLE SIDE OF THE CABINET.

NOTE: Prior to removing the backing from the sensor, the surface of the cabinet flange needs to be prepared using an alcohol wipe to remove any dirt or residue.

- 1) The front vertical edge of the sensor (B) is located 5 ¼" (5.25") from the inside of the cabinet flange (A).
- 2) Locate the top of the sensor along the top edge of the bottom cabinet flange (C).

Door Sensor Replacement

1. Prepare the metal surface of the cabinet flange, use the first alcohol cloth to remove any dirt or residue from the previous sensor.
2. Do not remove the adhesive backing from sensor until it is in place.
3. Slide the new sensor into the gap between the bottom flange and trim piece.
4. Once the sensor is in place:
 - a. Remove the adhesive backer from sensor.
 - b. Ensure the sensor is in position and carefully adhere to the cabinet. Apply carefully using thumb pressure to the outer perimeter of the door sensor.
 - c. ***NOTE: Care should be taken not to apply unnecessary pressure directly on the raised vertical center of the sensor face. The switch is pressure sensitive; any undue pressure could damage the sensor.***
5. Replace the toe grill.

NOTE: A new door gasket with a stronger magnet was introduced into production at the end of April 2015.

The starting Serial Number for this change was 20150421xxxH. All units produced after this date will incorporate the new door gasket.

Anytime the above service kits (S41050470-varient) are ordered for a serial number built prior to 20150421xxxH, a new door gasket, with stronger magnet should also be ordered.

20.4: SERVICE BULLETIN # 41014167 Slotted Condenser Shroud

Complaint:

- The condenser fan motor cannot be replaced without disconnecting all the existing wiring passing through the hole in the fan shroud.

Correction:

- The new fan shroud is slotted from the bottom of the hole in the fan shroud to the bottom edge of the shroud surface.
- To replace the fan motor, simply remove the fan shroud assembly as mentioned in Section 4, remove the protective plastic grommet inside the diameter of the hole, tip the shroud assembly and remove the wires from the slot.

Models Impacted: Most ML and MP models (excludes ice machines).

Serial Number Range: Production prior to 20150505033H

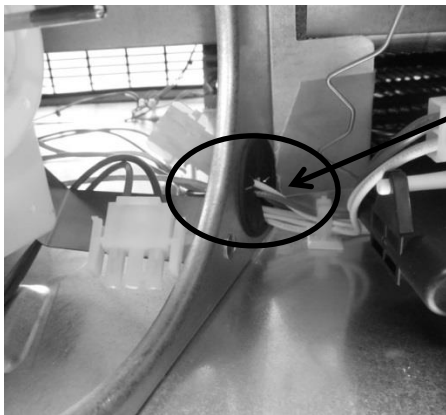

Original Fan Shroud

Wire bundle passing through the plastic grommet inserted into the condenser shroud.

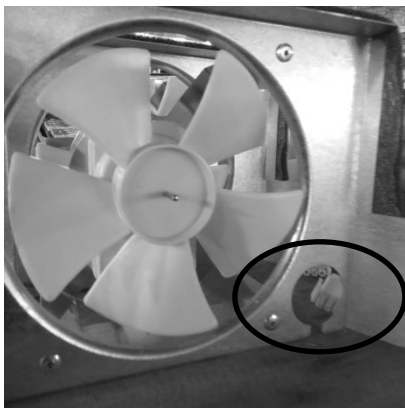
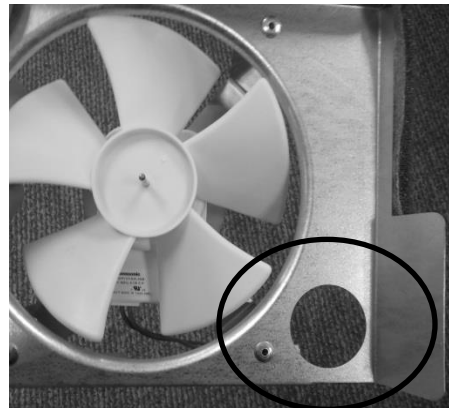

Revised Fan Shroud



20.5: SERVICE BULLETIN # 41014168

Showroom Mode Alarm

Complaint:

- Appliance sounds an audible alarm when in the showroom mode.

Diagnosis:

- An audible alarm sounds every 45 seconds after an “undetermined” amount of time once the appliance is placed in the showroom mode.
- No error code will be displayed on the user interface display.
- The firmware installed on the main power board has an alarm feature installed that sounds once the appliance is placed in the showroom mode.
- The firmware is not detrimental to the operation or performance of the appliance. This alarm will not activate unless left in the showroom mode. During normal usage, the alarm will not sound.
- The error is not the fault of the user interface display. The main power board located in the machine compartment must be replaced.
- The main power board is not adjustable or reprogrammable; it must be replaced.

Models Impacted:

- ML and MP (excludes ice machine) models built within the serial number range listed below.

Serial Number Range:

- All models built prior to the manufacturing date of May 18, 2015 (20150518xxxH).

Repair:

- Replace the main power board (located in machine compartment). The user interface board does not come into play with this error.

Service Kit:

Provide complete model and serial numbers to ensure that the main power boards are programmed to the specific model. These boards are not field adjustable or interchangeable between models. They are programmed model specific.

- **Part Numbers**

- **S41050480 Single Zone Appliance***
- **S41050401 Dual Zone Appliance***

***Available per model type, contact customer service at 1-800-223-3900**

Service Procedure:

- Disconnect the appliance from the power supply.
- Gain access to the machine compartment.
- Disconnect wiring from the main power board.
- Remove old main power board and replace with new.
- Discard old board.
- Return the appliance back into operation.

20.6: SERVICE BULLETIN # 41014169

Evaporator / Heat Exchanger Replacement

(RF and RFI Models ONLY)

Complaint:

- Not getting cold
- Not cold enough
- Long run time

Diagnosis:

- Evaporator Leak
- Welded aluminum / copper seam leak
- Restriction

Correction:

- The evaporator heat exchanger assembly must be replaced. Refer to **Section 16** for access to the evaporator assembly.
- The heat exchanger is foamed in place from the inside of the machine compartment to the inside of the freezer compartment.
- Since the original evaporator heat exchanger assembly cannot be removed, the replacement assembly must be routed out the back of the cabinet and down into the machine compartment to the compressor.

Models Impacted:

- ML and MP models built within the serial number range listed below.

Serial Number Range:

- Serial number range: All

Service Kit Number:

- 42249121*
- *** THIS KIT IS ONLY FOR RF AND RFI MODELS.**

This replacement is performed similar to that described earlier in this section with the following exception.

- **The heat exchanger will be run through the back wall of the cabinet (not down through the drain section and out into the machine compartment).**

Kit Components:

- Evaporator
- Heat exchanger
- Filter drier
- Suction line insulation
- Permagum
- Suction line cover panel
- 3 p-clamps
- 12 sheet metal screws
- 2 aluminum defrost heater straps

Procedure:

- Disconnect power to appliance.
- Access evaporator compartment per **Section 16**.
- Reclaim refrigerant.
- Cut away and discard exposed evaporator and heat exchanger assemblies.
- Install new evaporator assembly per the kit instructions.
- Charge and leak check seal system.
- Reassemble all components.

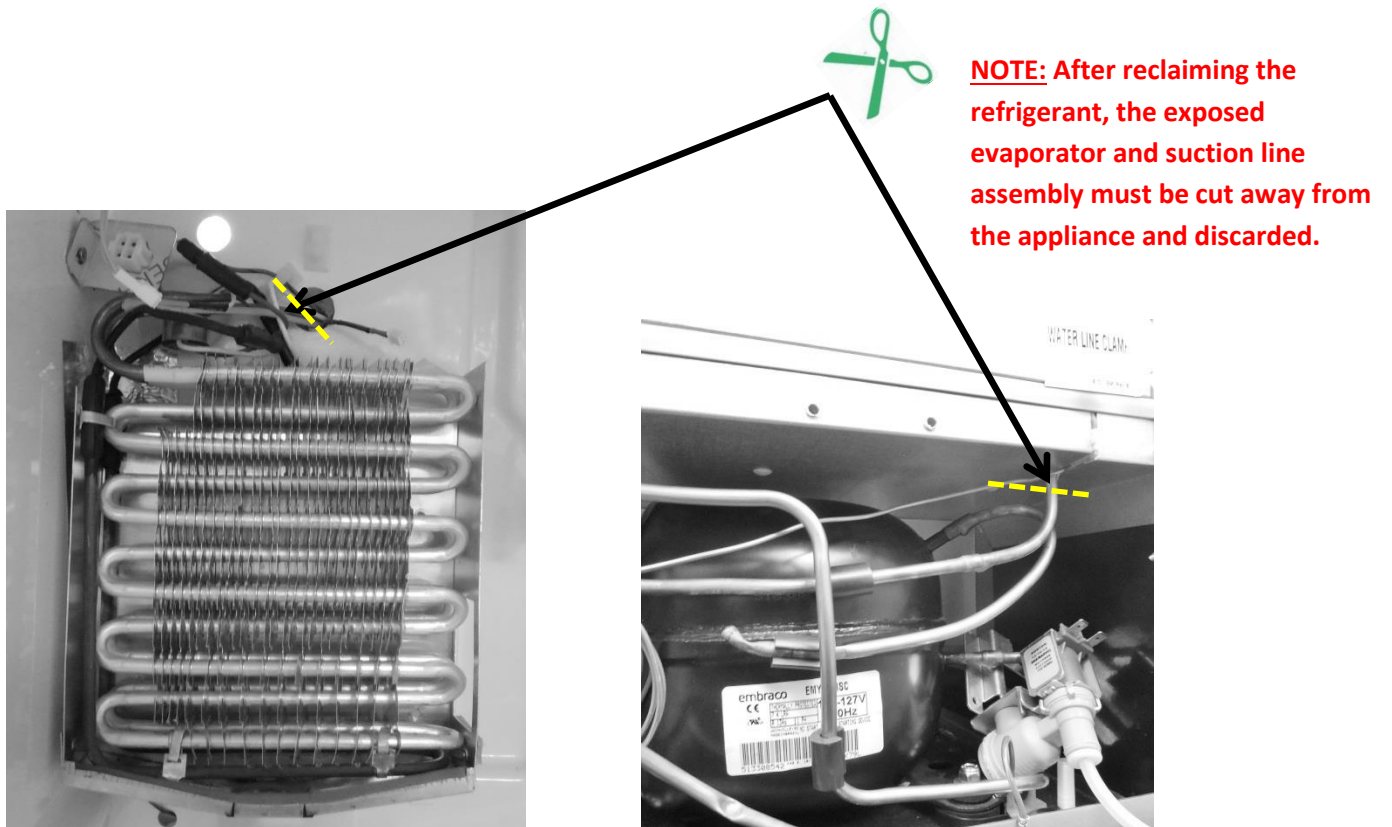

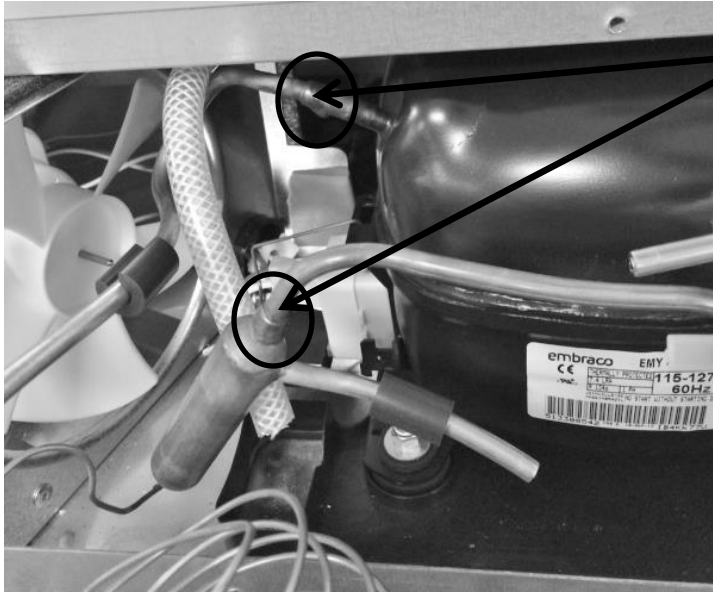

Un-braze the remaining suction line and the filter drier at these joints.

Completely remove water fill assembly.

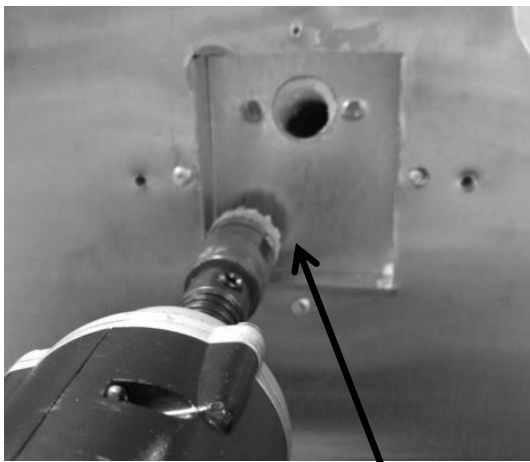
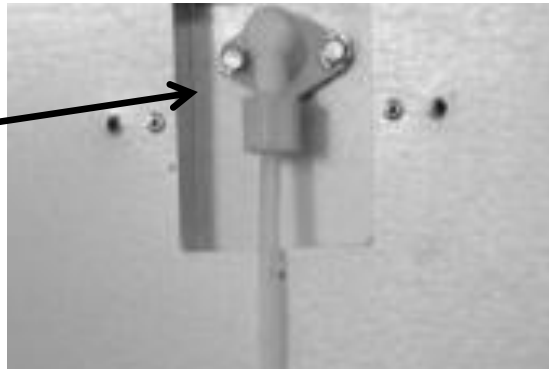

Use a 1" hole saw to completely drill through the bottom left hand corner inside the water fill tube recess.

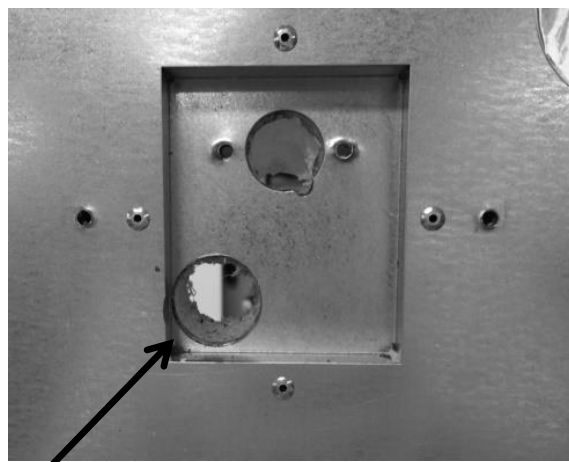

The location of the finished hole.

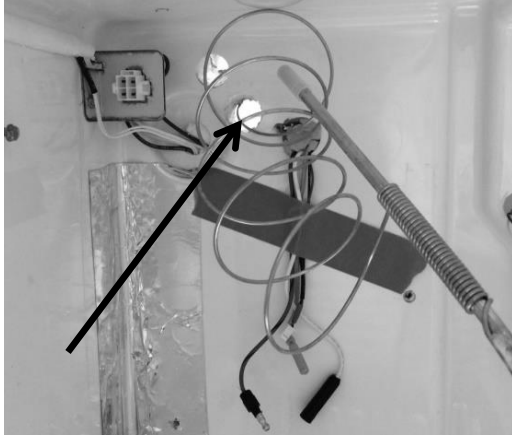

Feed the capillary tube and suction line of the new evaporator assembly (inside to the outside) through the 1" hole.



Replace heater, defrost termination thermostat, and zip tie the thermistor to the evaporator.

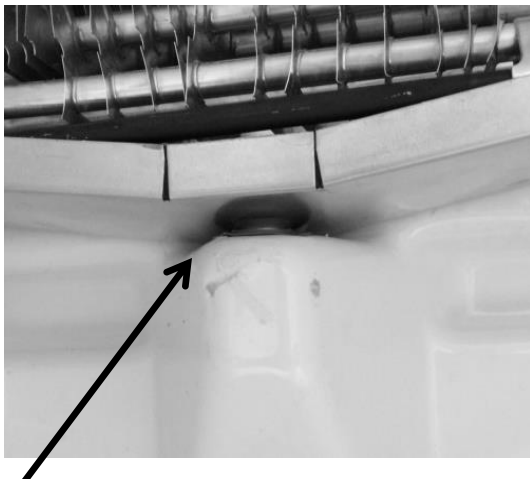

Make certain that the drip pan drain fits snugly into the drain tube.

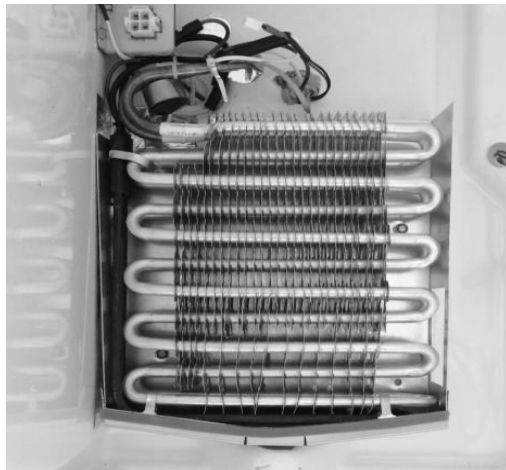

Install the 2 drain pan screws to secure the evaporator assembly. REMEMBER to stuff permagum into the 1" hole drilled for the heat exchanger.

Insert the Insulation Tube over the suction tube / capillary assembly and zip tie in place.

The capillary tube on the bottom end can now be coiled and zip tied after determining the length needed for installing into the filter drier.

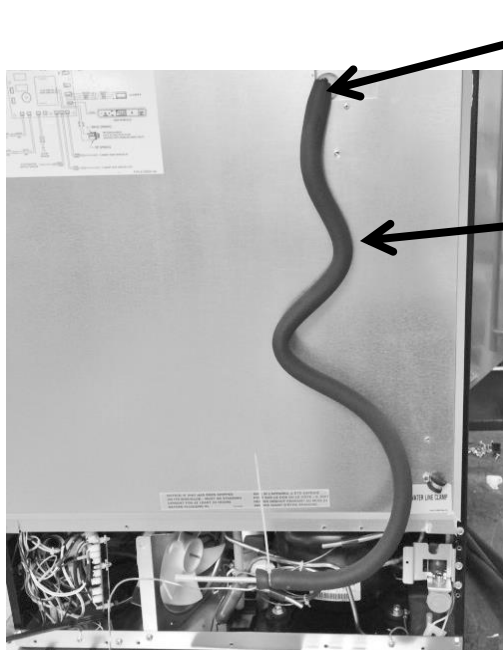

⚠ CAUTION: This bend must be made with caution to prevent collapsing, pinching, or restricting the tubing radius.

⚠ CAUTION: DO NOT CUT. It is critical not to eliminate any tubing length. This is necessary to eliminate the possibility of excessive evaporator feed noise. The entire length of suction/capillary tubing supplied with the assembly must be used. Route the tubing down the outside back wall similar to the picture.

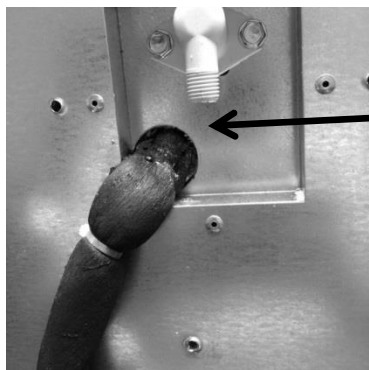

Reinstall the fill tube and secure.

Fill the 1" hole with the stuffer plug provided; make sure that the foam insulator tube is tucked completely inside the 1" hole.

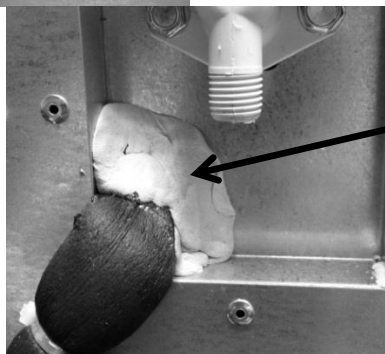

Apply permagum as shown.

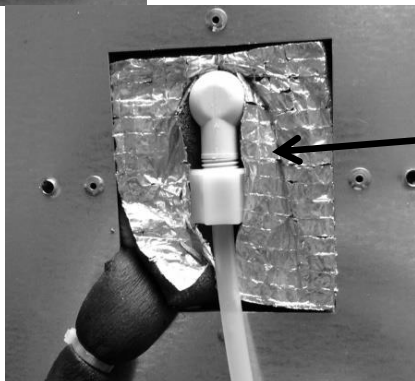

Reinstall the water line.

Install foam insulation pad as shown.

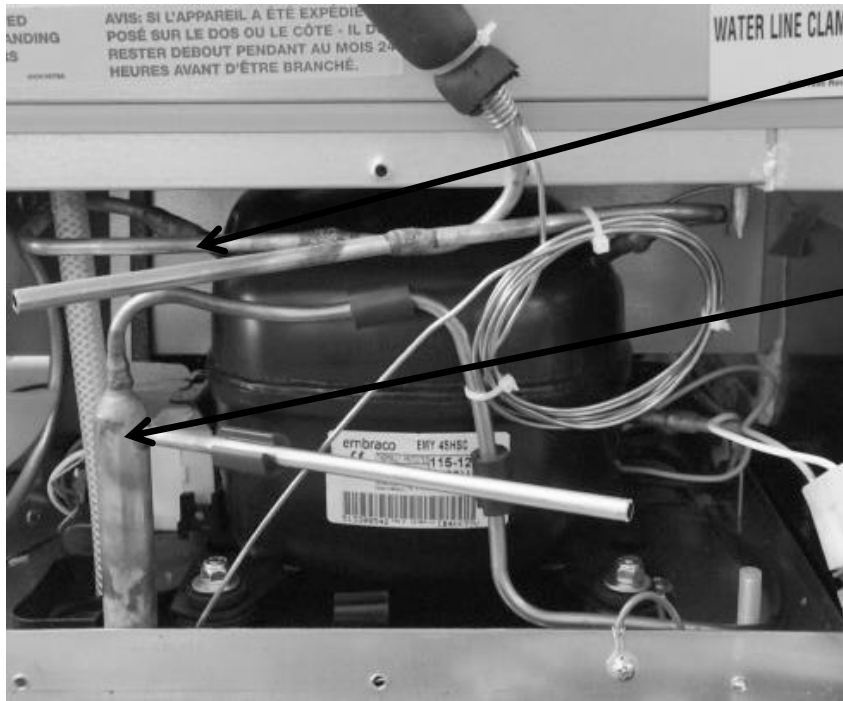

Install and braze the ¼" suction line extension (jumper tube) into the compressor and new suction line.

Install and braze the filter drier.

Once the tubing has been brazed and the system closed; pull a vacuum, leak check, and weigh charge per the specified amount on the serial plate.

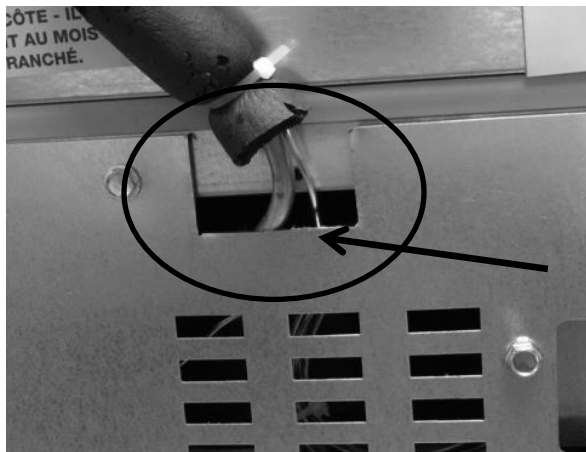

Notch out a clearance hole on the rear access panel to accommodate the suction line and capillary tube.



Attach the back cover and return to operation.



20.7: SERVICE BULLETIN # 41014241 Shelf Shim Kit (Non-Professional Models)

Service Kit: 42249228

Models Affected: All non-professional models

Serial Number Range: All

Contents: 6 washer packages of assorted thicknesses and density.

Application: Shim kit to correct shelving falling out of support track due to dimensional variances.



Tools Needed:

- #2 Phillips screwdriver
- Slipjoint pliers

Step #1:

Check that the shelf rollers are not bent. Shelf rollers should be parallel to the shelf rail. If a roller is bent, use pliers to bend the roller back to the correct position and check to see if shelf still falls out of rail.



These photos show the correct orientation of the shelf roller. They should be in a vertical upright position without appearing at an angle.

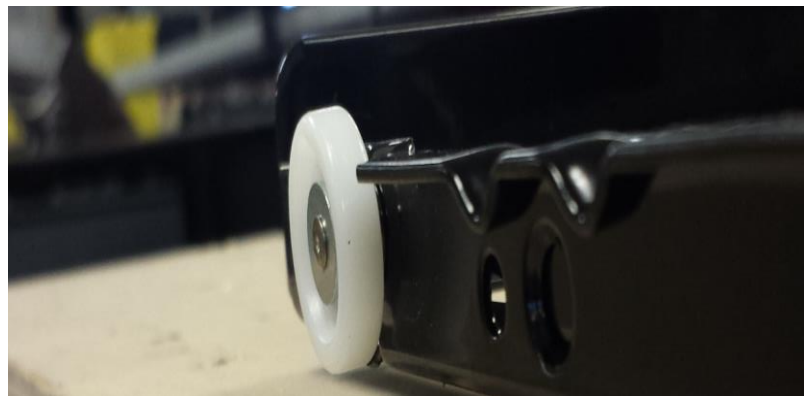

Step #2:

If shelf still falls out of rail, confirm that the shelf shims in use are correct per the following, correct if necessary, and re-check shelf support.

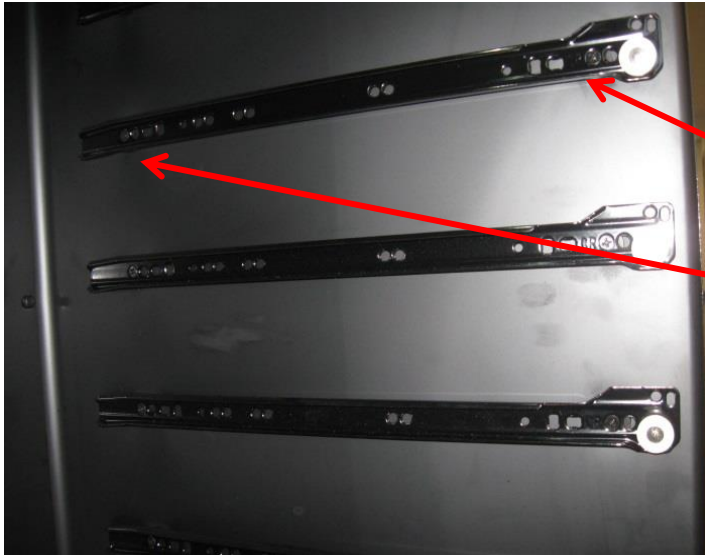

Hinge-Side Full-Shelf

**0.330" - [Front]
0.210" - [Rear]**

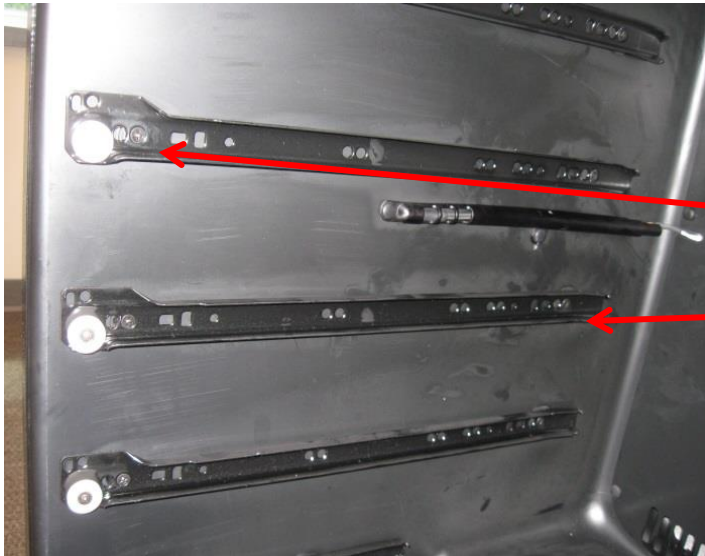

Handle-Side Full-Shelf

**0.12" - [Front]
No Shim - [Rear]**

Step #3:

If shelving still falls out of support, add additional shim(s) as necessary. Kit includes 0.09" hard plastic and 0.090" & 0.060" rubber shims for this step.

- First, add 0.090" hard plastic shims at front and rear of the **handle side**. If shelving continues to fall out, add another 0.09" shim to front and rear as appropriate.
- If use of 0.090" hard plastic shim makes shelf fit too tight, (no longer rolls freely in & out), use of a 0.090" or 0.060" rubber shim may be used. Because this rubber shim is compliant, the mounting screw can be used to compress the shim for fine-tuning.

20.8: Service Bulletin # 41014242

Miscellaneous Control Communication Errors

Models Affected: All

Serial Number Range: All

Complaint: Unidentifiable errors seen on the User Interface display.

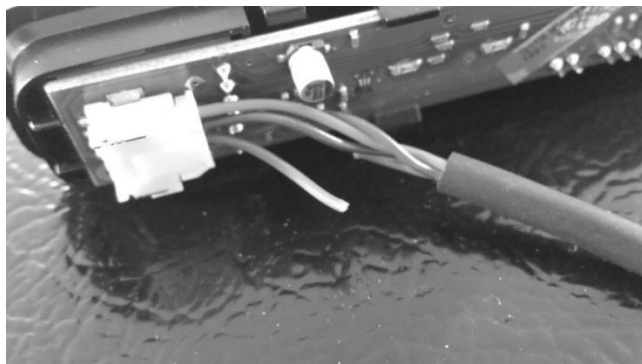

The photos to the left show a definite communication error (cE), the result of this was a broken brown wire in the cable itself. This can occur inside a connector at the user interface, the bottom of the door, the main control board, or a broken wire anywhere in the cable itself.

Other possible errors are:

1. A simultaneously flashing VAC and (dash) –
2. A flashing (dash) –
3. The display showing 00 with a flashing Power Failure

The above three errors are caused by some degree of either loose, broken, or shorted wiring in the communication cable.

Communication cables are foamed inside both the door and the cabinet. A broken wire inside either the door or cabinet can not be repaired.

20.9: Service Bulletin # 41014243 Replacement of MP Door Skins

Replacement of a Marvel Professional Model Door Skin (caused by damage)

Models Affected: All

Serial Number Range: All

Tools Needed:

- Phillips screwdriver
- 3/32: hex (allen) wrench

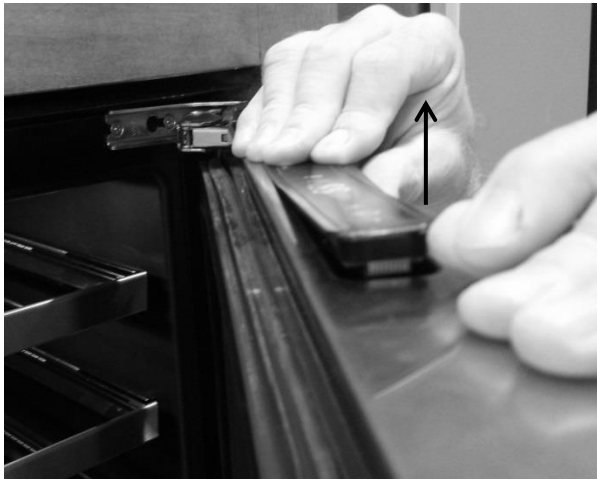

Lift up on the left hand side of the user interface display. Once the display is unseated, raise it high enough from the door boot to disconnect the wire harness.

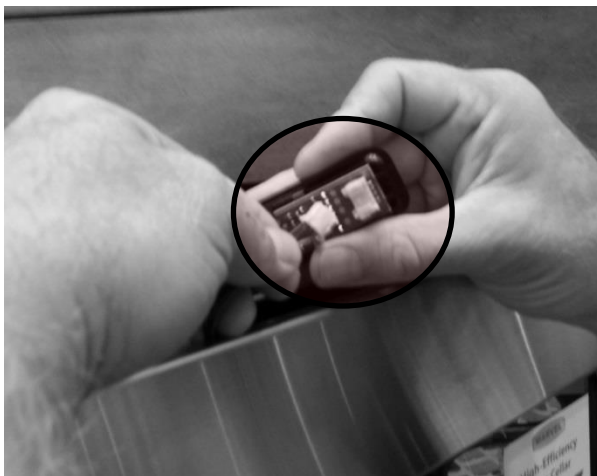

Turn the user interface over, press the disconnect lock and separate the display from the wire harness.



Remove the two Phillips screws on the top inside of the door frame.



Remove the two Phillips screws on the bottom inside of the door frame.

NOTE: Now that the door skin has been loosened, the side of the door skin may want to grab and hold onto the hinge side of the door. CAREFULLY and gradually work free.

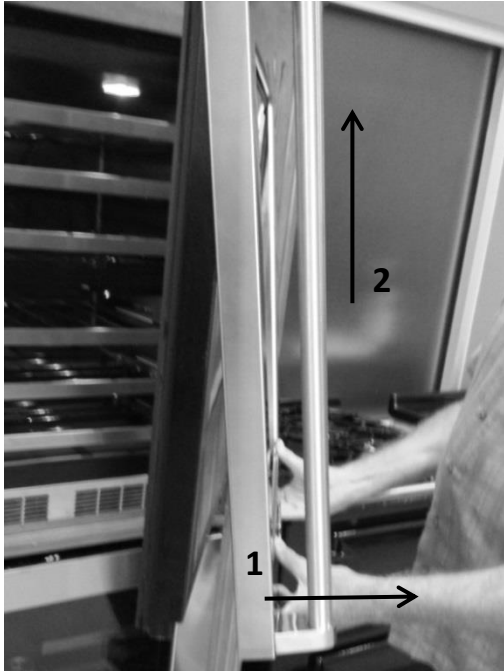

1. Grasp the bottom of the door skin and pull forward away from the door.
2. Carefully lift upward so the user interface harness can be removed.

Continue to lift the door skin from the top of the door. The lock assembly will be removed with the door skin.

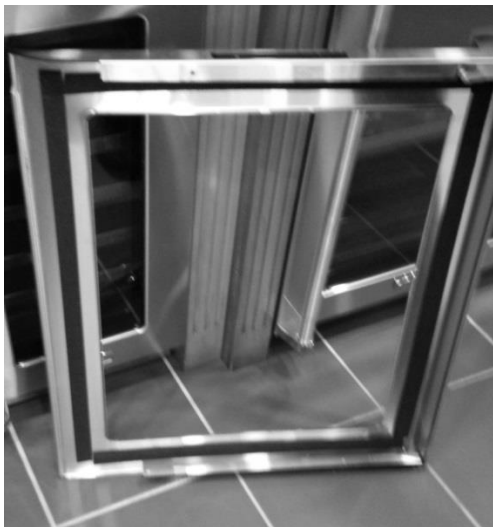
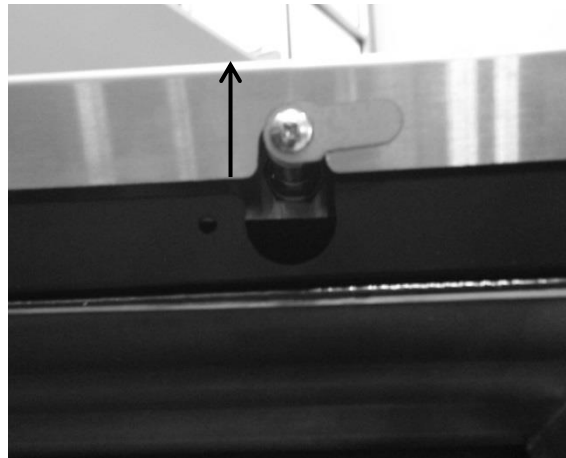

The handles will have to be removed and transferred to the new door assembly.

Reassemble the door skin to the door in reverse order that it was removed.

Section 21: AGA Marvel Customer Service

TECHNICAL SERVICE: 1-800-223-3900*

PART ORDERS: 1-800-223-3900*

*(*Follow the phone queue to reach the correction extension)*

Marvel Service Documentation: www.marvelservice.com

Contact: 1-800-223-3900 if you do not already have a password to access the web site.

Documentation includes:

- Owners Guides
- Installation Literature
- Part Instructions
- Parts Manuals
- Service Bulletins
- Diagnostic Flow Charts
- Control Operational Instructions

Office Hours: Monday through Friday 8:00 AM – 5:00 PM EST

www.marvelrefrigeration.com

NOTES

NOTES



www.marvelrefrigeration.com



AGA MARVEL
1260 E. VanDeinse St.
Greenville MI 48838

800.223.3900

All specifications and product designs subject to change without notice. Such revisions do not entitle the buyer to corresponding changes, improvements, additions, replacements or compensation for previously purchased products.

41013818- Rev B
8/12/15