



en
sp

USER MANUAL

Ultrasonic Humidifier

Model: SCK-3Q60B

Item: 4068194

Rated voltage: 120V

Rated power: 105W

Frequency: 60Hz

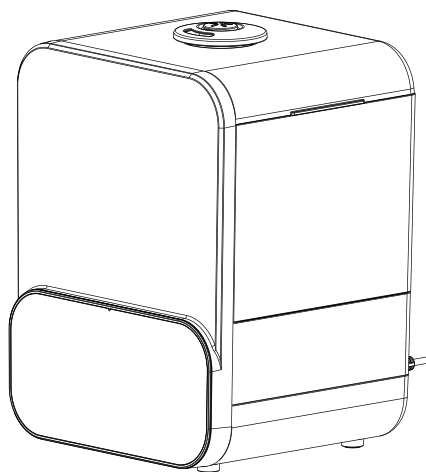

Warning Notice: Before using this product, please read this manual carefully and keep it for future reference. For additional support, please call customer service at 1-866-646-4332.

The design and specifications are subject to change without prior notice for product improvement. Consult with your dealer or the manufacturer for details.

SCK-3Q60B

midea.com

READ AND SAVE THESE INSTRUCTIONS

OWNER'S MANUAL

SAFETY PRECAUTIONS	2	INSTRUCTION FOR USE	6
SAFETY WARNING	3	OPERATION INSTRUCTIONS	8
RULES FOR SAFE OPERATION	4	CLEANING AND MAINTENANCE	9
ASSEMBLY	4	SERVICE GUIDE	10
SPECIFICATIONS	4	SERVICE AND SUPPORT	11
PARTS AND FEATURES	5	ONE (1) YEAR LIMITED WARRANTY	12

Read This Manual

Inside you'll find many helpful hints on how to use and maintain your appliance properly. Just a little preventive care on your part can save you a great deal of time and money over the life of your appliance. You'll find many answers to common problems in the troubleshooting tips - you should be able to fix most of them quickly before calling customer service. These instructions may not cover every possible condition, so attention to safety details is required when operating and maintaining this product.

SAFETY PRECAUTIONS

To prevent injury to the user or other people and property damage, the instructions shown here must be followed. Incorrect operation due to ignoring of instructions may cause harm or damage. The different levels of risk is shown by the following indications.

WARNING

This symbol indicates a hazardous situation which, if not avoided, could result in death or serious injury.

CAUTION

This symbol indicates a hazardous situation, which, if not avoided, could result in minor or moderate injury.

NOTICE

This symbol addresses practices not related to physical injury.

SAFETY WARNING

- Please always place the unit on a smooth, flat, lint-free, non-metallic, water-proof and level surface and keep it away from direct sunlight;
- Always place the unit 2 feet (60 cm) above the floor, 12 inches (30 cm) away from the wall, other appliances or wooden furniture;
- Do not place the unit on carpet, towel or wood surface, which will block the vent and may damage the unit.

CAUTION

- Turn on the power, do not use wet hands to plug and unplug the power plug, so as to avoid electric shock;
- Do not start up the machine when there is no water in its water tank;
- Do not add any additives into the water tank that are not produced or supervised by our company;
- Do not put or place anything or pets into the water tank;
- Do not add water to the atomization outlet;
- When the humidifier is working, do not touch the water in the tank or the parts sank in the water;
- Do not cover the atomization outlet, and please keep it clear above the outlet;
- Do not replace the power cord without authorization, or connect the power cord halfway or use other appliances in parallel;
- Do not place the appliance near water source;
- Do not disassemble, modify or repair internal parts without authorization;
- Do not climb or sit on the appliance;
- Do not store in flammable and explosive goods around the humidifier, and do not place it near a heat source; Do not directly flush the humidifier with water;
- Do not turn off the humidifier by unplugging the power cord directly
- Please use filtered or distilled water to avoid white dust. Do not use hard water.
- Please do not use a damaged or worn power cord; Do not replace the power cord without authorization. If the power cord is damaged, it must be replaced by the manufacturer, its service department or professional from similar department to avoid danger.
- The power must be cut off in thunderstorm;
- When an abnormal phenomenon (like a burnt smell) occurs, the operation must be stopped and the power supply is cut off.
- Please unplug the power cord and clean the water tank, when the appliance is not used for a long time;
- To avoid bacterial growth, please always change the water in the water tank and the water in the water tray;
- When the appliance is moved, please unplug the power cord to keep the water tank stable and to prevent the water from overflowing in the water tank;
- If the appliance is tilted when filled with water, be sure to unplug the power cord immediately and send it for inspection.

- The suitable ambient temperature for use of this product: 41°F-104°F, relative humidity: <80%RH (Please use pure water with temperature is less than 104°F)
- Do not run cord under carpeting.
- Do not cover cord with throw rugs, runners, or similar coverings.
- Do not route cord under furniture or appliances.
- Arrange cord away from traffic area and where it will not be tripped over.
- The accuracy rate for the humidity indication is approximately $\pm 10\%$ RH, time is needed when measuring the humidity. There will be minor accuracy rate difference among the qualified sensors, and the location of placing would impact the accuracy rate as well.

RULES FOR SAFE OPERATION

WARNING

- Please be sure to unplug the power cord before filling water.
- The level of the water added shall not be higher than the highest water level;
- Do not to add the water in the atomization outlet when the water is added
- Do not to lift the transparent part of the upper end of the water tank by hands when the water is added;
- Please do not add additives like essential oil, perfume, drug, etc. to the water. But you can add aroma liquid in the built in aroma tray.
- Please use the purified water or distilled water below 104°F(40).

ASSEMBLY

This humidifier is pre-assembled in factory.

SPECIFICATIONS

NOTICE

- The following are the design parameters of SCK-3Q60B. The measured parameters are subject to the product; The humidification amount will vary, depending on the temperature and humidity in the room. Actual humidification amount is not less than 90% the standard 250ml/h.

Model	Rated voltage	Rated frequency	Rated power	Volume of water tank	Net product weight	Dimensions
SCK-3Q60B	120V ~	60Hz	105W	6L	3kg	235*325*205 mm

PARTS AND FEATURES

⚠ NOTICE

- The pictures of the manual are for reference only.

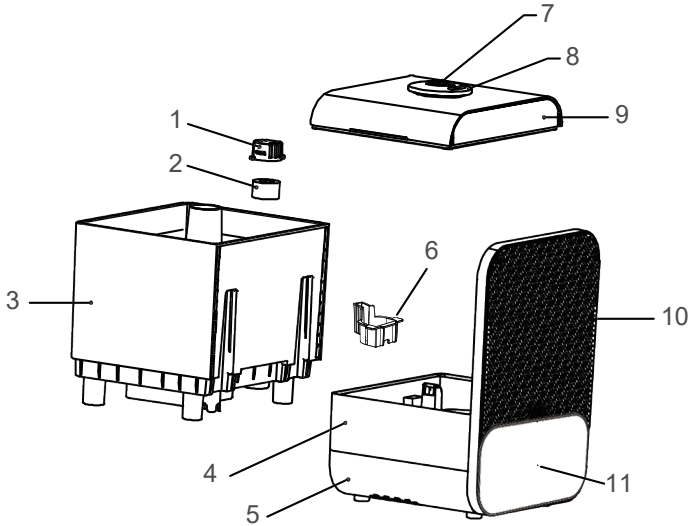

NO.	Description	NO.	Description
1	Filter cover	7	Essential Oil Tray
2	Filter Sponge	8	Atomization outlet
3	Water tank	9	Tank cover
4	Shell	10	Front panel
5	Base	11	Display control panel
6	Gland		



Manual × 1

INSTRUCTION FOR USE

Methods A

1. Remove the water tank.
2. Remove the lid of the tank.
3. Pour cold/warm (not over 100 °F) distilled or filtered water into the water tank.

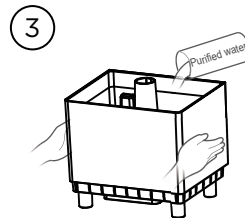
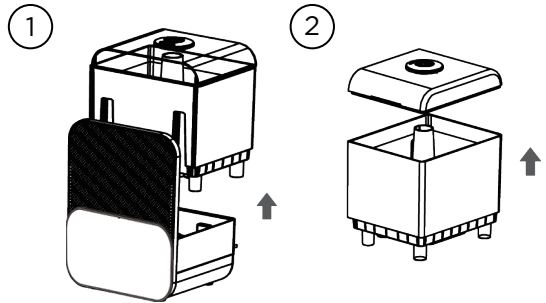

Methods B

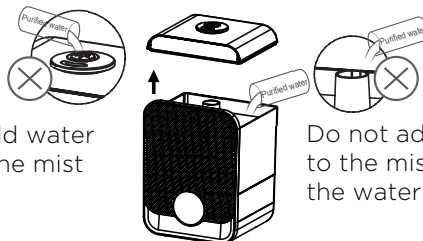

Do not add water through the mist outlet

Do not add water to the mist pipe of the water tank

Take off the water tank cover to the water tank; It is forbidden to add water at the mist outlet and the mist pipe of the water tank

Installation of the water tank

If the water is added as previously described, the water tank cover is covered with the water tank. When installing back to the lower shell, it is necessary to ensure that the two buckle grooves on the water tank and the surface plate are in place.

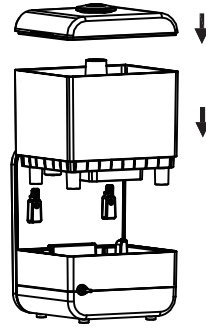

Atomizing direction adjustment

The atomization outlet can be rotated by 360°, which can be adjusted according to your own needs, so that atomizing direction satisfies your needs.

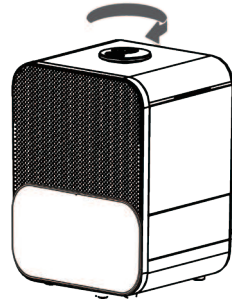







ATTENTION: When the device has run out of water it will enter into the lack of water mode. Pour water into the water tank and the humidifier will resume working.

OPERATION INSTRUCTIONS



The current environmental humidity is displayed by default Humidity value Unit: %RH

Buttons	Operation
 On/Off	<ol style="list-style-type: none"> 1. Press the button in standby state to enter the power-on state. 2. Press the button in the boot state to enter the standby state.
 Humidity	Under the working state, press the button, according to: 01 (low) →02 (middle) →03 (high) →01→... Of the sequence cycle to switch the mist volume gear.
 LED Light	When the machine is on, press the button: red→ green→ blue → out → red →... The sequence of loops toggles the color of the atmosphere light.
 Timer	In the power-on state, press the button: 0h→1h→2h→4h→8h→0h→... The sequential loop sets the scheduled shutdown time.
 Auto	When the unit is turned on and the constant humidity function is off, press the button to turn on the ECO humidity function , press it again to turn off this function.
 Warm	When the unit is turned on, press this button to turn on the warm mist function, press it again to turn off the function.

CLEANING AND MAINTENANCE

WARNING

- Please be sure to unplug the power cord before cleaning.
Please be sure to remove scale and debris in the humidifier tank regularly and it is recommended to clean it once every 3 days.

EXTERNAL CLEANING OF HUMIDIFIER

Rinse soft cloth in warm water below 104°F, add a small amount of mild dish soap to soft cloth, and wipe off any surface stains.

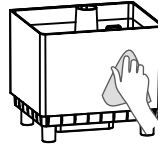

Remove the filter cover and sponge from the water tank by rotation, and clean them directly with clean water



Water tray and atomizer cleaning

Add detergent or water to clean, and then rinse thoroughly after cleaning.

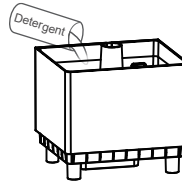

Flume and atomizer cleaning

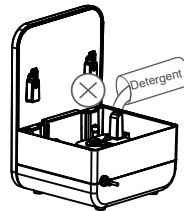
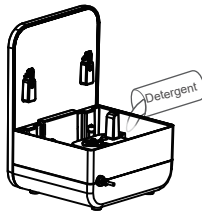

When cleaning the lower shell, take out the gland first, add detergent or calen water , rinse after cleaning

Warning: Do not put water into the product when flushing, otherwise there is a risk of electric shock

SERVICE GUIDE

NOTICE

- If the humidifier does not work properly after the following suggestions, please contact the customer service center or local service station.

PROBLEM	CAUSE	SOLUTION
The humidifier does not work	The power plug is not plugged well	The power plus is plugged well
	There is no water in the water tank	The water is added to the tank
	The water tank is not in place	The water tank is fastened in place
Mist has a bad odor	The water, tank, or base is not clean.	The clean water is refilled, or the water tank and water tray are cleaned
Humidifier is emitting a white dust/residue.	Use of tap water with a high mineral content, aka "hard water."	Clean tank and base and use only demineralized or distilled water.
There is abnormal noise	The appliance is not in place, tilted or unstable	The appliance is placed on a solid surface or a flat place
The water tank shows water shortage, but is filled with water; the humidifier does not work for a long time.	Excessive tilting of the appliance at an angle causes the water level in the water tank to be judged as low water level, so the appliance automatically starts protection mode and stops.	The appliance is put on a flat and firm place, and kept steady

SERVICE AND SUPPORT

In the event of a warranty claim or if service is required for this unit, please contact us at the following:

Toll Free: 1-866-646-4332

For questions or comments, please write to:

Midea America Corp

759 Bloomfield Ave., # 386

West Caldwell, NJ 07006-6701

Customer Service: 866-646-4332

For your records, staple your sales receipt to this manual and record the following:

DATE OF PURCHASE: _____

PLACE OF PURCHASE: _____

(STAPLE SALES RECEIPT HERE)

**NOTE: PROOF OF PURCHASE IS REQUIRED FOR ALL
WARRANTY CLAIMS**

ONE (1) YEAR LIMITED WARRANTY

Please read all the instructions before attempting to use this product.

Midea America Corporation warrants as limited herein to the original purchaser of retail that each new Fan, shall be free of defects in material and workmanship for a period of one (1) year from the date of original purchase. This one (1) year warranty is limited to the Motor and Electric Element.

In the event of malfunctions or failure of your Fan, simply deliver or send the Fan, postage prepaid along with PROOF OF PURCHASE, within the warranty period of one (1) year, to Midea America Corporation. Midea America Corporation reserves the right to inspect the claimed defective part or parts to determine if the defect or malfunction complaint is covered by this warranty. Midea America Corporation shall, within sixty (60) days after receipt of the product, at its option, repair and/or replace the defective part or parts free of charge. This warranty shall only cover defects arising from normal usage. Midea America Corporation assumes no responsibility whatsoever if the Fan should fail during the warranty period by reason of:

- Misuse, negligence, physical damage or accidents.
- Lack of maintenance (see instructions for proper maintenance).
- Repair by any unauthorized party during the warranty period.
- Damage caused by connection to an improper input voltage (see specification label on your Fan).

Midea America Corporation makes no further warranties or representations, express or implied except those contained herein. No representative or dealer is authorized to assume any other liability regarding the Fan. The duration of the implied warranty granted under State law, including warranties of merchantability and fitness for particular purpose are limited in duration should the duration of the express warranty grant it hereunder. Midea America Corporation shall in no event be liable for direct, indirect, special or consequential damages.

Some states do not allow limitations on how long an implied warranty lasts, and/or the above limitations or exclusion may not apply to you. This warranty gives you specific legal rights and you may have other rights which vary from state to state.



make yourself at home