



True HEPA Air Cleaner with PLASMAWAVE[®] Technology

Model AUS-5500 Use and Care Guide



AUS-5500

CAUTION:

Read and follow all
safety rules and instructions
before operating this equipment.

TABLE OF CONTENTS

Warranty.....	2	Display Panel.....	6
Package Contents.....	2	Operation.....	7
Safety Instructions.....	3	Remote Control.....	8-9
Product Specifications.....	4	Care and Maintenance.....	10-11
Air Cleaner Features.....	4	Troubleshooting.....	12
Air Cleaner Set-Up.....	5		

WARRANTY

WINIX Air Cleaner 1 Year Limited Warranty

When installed, operated and maintained according to all instructions supplied with this product, Winix, at its option, will repair or replace the product if it fails because of a defect in material or workmanship, as determined by Winix. Proof of the purchase date must be verified before any warranty work will be completed. All warranty coverage applies for only one year from the date of purchase. This warranty will be null and void if the product is used for purposes other than home consumer purposes.

This warranty covers only defects in material and workmanship. WINIX will NOT pay for:

1. Expendable items that can wear out from normal use, including but not limited to filters and remote controls.
2. A service technician to instruct the user in correct product installation, operation or maintenance.
3. A service technician to clean or maintain this product.
4. Damage to or failure of this product if it is not installed, operated or maintained according to all instructions supplied with the product.
5. Damage to or failure of this product resulting from accident, abuse, misuse or use for other than its intended purpose.
6. Damage to or failure of this product caused by the use of detergents, cleaners, chemicals or utensils other than those recommended in all instructions supplied with the product.
7. Damage to or failure of parts or systems resulting from unauthorized modifications made to this product.

Disclaimer of implied warranties; Limitation of remedies

Customer's sole and exclusive remedy under this limited warranty shall be product repair as provided herein. Implied warranties, including warranties of merchantability or fitness for a particular purpose, are limited to one year or the shortest period allowed by law. WINIX shall not be liable for incidental or consequential damages. Some states and provinces do not allow the exclusion or limitation of incidental or consequential damages, or limitation on the duration of implied warranties of merchantability or fitness, so these exclusions or limitations may not apply to you.

PACKAGE CONTENTS

- Winix PLASMAWAVE® Air Cleaner w/ True HEPA, 1 Carbon Filter and 1 Pre-Filter
- 3 Replacement Carbon Filters
- Remote Control (1 unit)
- Batteries (2 AA batteries)
- Use and Care Guide

SAFETY INSTRUCTIONS

Thank you for purchasing a Winix air cleaner. Please read this manual carefully before using. This product is for household use only.

IMPORTANT CAUTIONS FOR USING YOUR AIR CLEANER

WARNING: Follow the instructions in this manual to reduce the risk of electric shock, short circuit, and/or fire:

- Do not repair or modify the unit unless specifically recommended in this manual. All other repairs should be completed by a qualified technician.
- Do not use if the power cord or plug is damaged or the connection to the wall outlet is loose.
- Use AC 220~240V only.
- Do not damage, break, forcefully bend, pull, twist, bundle, coat, pinch, or place heavy objects on the power cord.
- Periodically remove dust from the power plug. This will reduce the chance that humidity will accumulate, which increases the risk of electric shock.
- If the power plug is damaged, it must be replaced by the manufacturer or a qualified technician.

IMPORTANT INSTRUCTIONS FOR USING YOUR AIR CLEANER

- Do not block the intake or outlet vents.
- Do not use near hot objects, such as a stove. Do not use where the unit may come into contact with steam.
- Do not use the unit on its side.
- Keep away from products that generate oily residue, such as a deep fryer or incense.
- Do not use detergent to clean the unit.
- Do not operate without a filter.
- Do not wash and reuse the True HEPA Filter.
- Remove the power plug from the outlet before cleaning the unit. When removing the power plug, grasp by holding the plug itself, never hold by the cord.

- Remove the power plug from the outlet when the unit is not in use.
- Do not handle the power plug with wet hands.
- Do not operate the unit when using indoor smoke-generating insecticides.
- Do not clean unit with benzene or paint thinner. Do not spray insecticides on the unit.
- Do not use the unit where it is humid or where the unit may get wet, such as in a bathroom.
- Do not insert fingers or foreign objects into the air intake or outlet.
- Do not use the unit near flammable gases. Do not use near cigarettes, incense, or other spark-creating items.
- Unit will not remove carbon monoxide emitted from heating appliances or other sources.
- If the supply cord is damaged, it must be replaced by the manufacturer, its service agent or similarly qualified persons in order to avoid a hazard.”
- This appliance is not intended for use by person (including children) with reduced physical sensory or mental capabilities, or lack of experience and knowledge, unless they have been given supervision or instruction concerning use of the appliance by a person responsible for their safety.
- Children should be supervised to ensure that they do not play with the appliance.

PRODUCT SPECIFICATIONS

Area Served	350 sq. ft. (33 sq. m)
CADR	216/235/251 (Dust/Smoke/Pollen)
Power Supply	220~240V~, 50/60Hz
Power Rate	Low 6W, Turbo 90W
Fan Speed	4 Speeds
Control Type	Auto/Manual
Motor Type	BLDC Motor
Air Quality Sensor	Yes
Sleep Mode	Yes
Cleaning System	Pre Filter Carbon Filter True HEPA Filter PLASMAWAVE® Technology
True HEPA Filter	99.97% (of airborne pollutants @ 0.3 microns)
Color	Metallic Silver/White
Remote Control	Yes
Unit Dimension	41 (W) X 22 (D) X 55 (H)
Unit Weight	6.8Kgs

AIR CLEANER FEATURES

• Ultra-Quiet Operation

This Winix air cleaner has a multi-speed fan with ultra-quiet operation that is ideal for nighttime operation.

• Easy Maintenance

Winix air cleaners are simple and economical to maintain. For optimum performance, replace True HEPA Filter when CHANGE FILTER indicator light is on.

• Air Quality Sensor

The 5500 air cleaner is equipped with a digital sensor, that automatically monitors air quality. Fan speeds will adjust automatically.

• Simple Operation

The Winix 5500 air cleaner has a remote control and user-friendly display for your convenience.

• Sleep Mode

When set on Sleep Mode, display panel lights will dim and the unit will not go above low fan speed to help keep the room dark and quiet.

MULTI-STAGE CLEANING

Air undergoes four separate processes before returning, freshened and cleaned, to the room.

• Pre-Filter

Traps large particles such as pet hair, lint and pollen.

• Carbon Filter

Very effective Carbon Filter sheet collects large particles, dust, pollen, pet hair, and lint as well as odors caused by cigarette smoke, organic decay, and cooking.

• True HEPA Filter

Captures 99.97% of particles and impurities as small as 0.3 microns, including smoke, dust, pollen, mold spores, and pet dander.

• PLASMAWAVE®

In the final stage of cleaning, Winix PLASMAWAVE® technology generates both positive and negative ions to create plasma clusters which instantly neutralize viruses, bacteria, chemical vapors and odors in the air.

PLASMAWAVE® can be turned on and off using the remote control, however we recommend leaving it on all the time.

• Replacement Filter Indicator Light

Indicates when to replace the True HEPA Filter depending on usage.

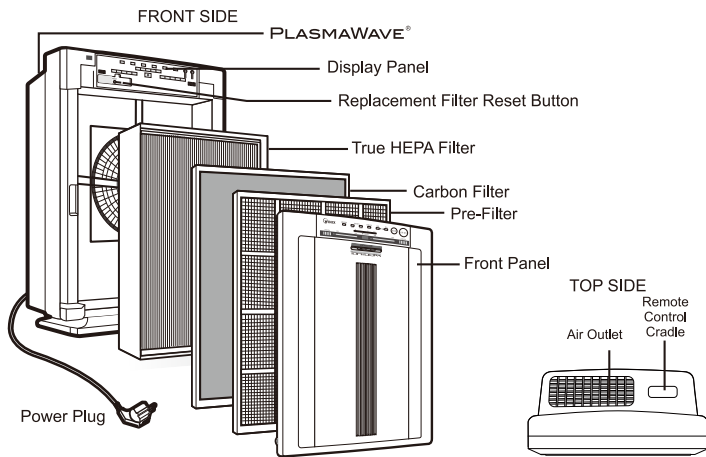

AIR CLEANER SET-UP

NOTE: Follow these instructions for best results.

- Place unit at least 30~46cms from equipment that emits electric waves such as televisions or radios.
- Place unit at least 10cms from the wall.
- Keep sensors away from drafty areas.
- Keep curtains away from sensors, as they may interfere with air intake/outlet.
- Place unit on a stable surface with plenty of air circulation.

1. Remove the front panel by grasping the bottom outside edges and gently pulling toward you.

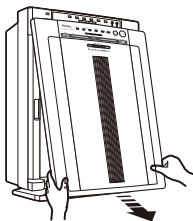

2. Pull out the filters and remove the sealed plastic wrap.

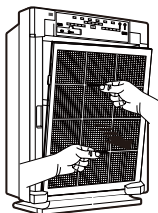

3. Return the filters into the main unit; The Carbon Filter should be in front of the True HEPA filter.

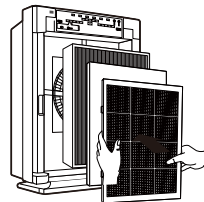

4. Replace the front panel by hooking the front panel on the top of the unit. Gently push the bottom of panel until it snaps into place.

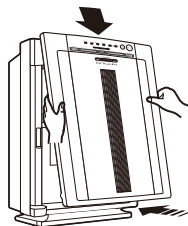

5. Plug in the power cord to a wall outlet.

6. Press POWER button until short "beep" is heard.

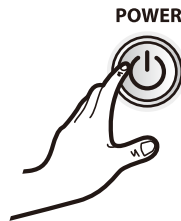

NOTE: For the first 4 minutes after turning the unit on, air quality indicator will flash while the unit measures air quality.

DISPLAY PANEL

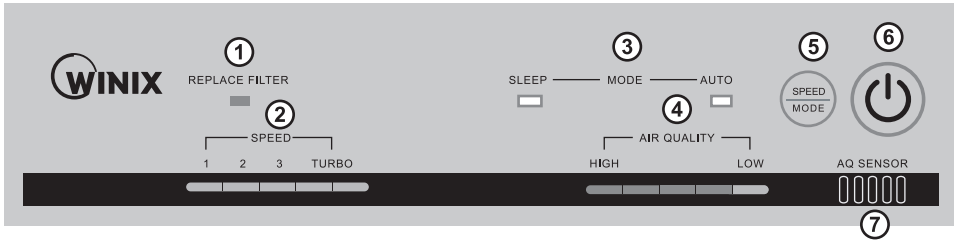

1. REPLACE FILTER INDICATOR - The indicator will illuminate when to replace the True HEPA Filter.

2. FAN SPEED INDICATOR - Shows current fan speed setting.

3. MODES

- Auto: The unit is set to default to AUTO mode when it is first turned on. The sensor will automatically adjust fan speed as needed.
- Sleep: When in SLEEP mode, the control panel will dim and the unit will operate quietly at the lowest fan speed.

4. AIR QUALITY INDICATOR - Shows current level of air quality in your room.

5. SPEED/MODE - Change the fan speed and modes between AUTO and SLEEP.

6. POWER BUTTON - Turn unit on and off.

7. AIR QUALITY SENSOR - Automatically monitors air quality level and adjusts fan speed accordingly.

Note: To get back into AUTO mode, SPEED/MODE button must be pressed on unit until AUTO light is lit.

OPERATION

AUTOMATIC OPERATION

The unit is set to default to Automatic operation when it is first turned on. The air cleaner will automatically sense the air quality, and adjust the fan speed accordingly.

MANUAL OPERATION

After you turn on the unit, you can switch to manual operation by using the FAN CONTROL button on the remote control or the SPEED/MODE button on the unit.

• 1, 2, 3, AND TURBO

Select your desired speed. The TURBO level, the highest fan speed, can be activated manually for maximum air circulation.

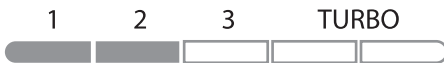
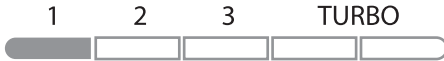

• SLEEP MODE

When set on Sleep Mode, display panel lights will dim and the unit will not go above low fan speed to help keep the room dark and quiet.

AIR QUALITY SENSOR

Air quality sensor shows elevated levels of poor air quality. The green light indicates acceptable levels, the orange light indicates medium levels, and the red light indicates poor air quality. If the unit is set on automatic operation, it will adjust fan speeds to compensate for changes in air quality.



REMOTE CONTROL

PREPARATION

- Press and slide the back cover of the remote to remove.
- Insert batteries as shown.
- Close the back cover.

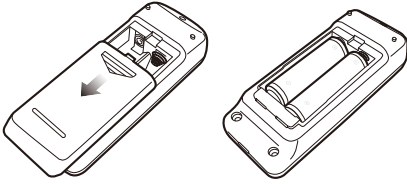

BATTERY USE

- The batteries for the remote control are for initial use only. Change the batteries when necessary.
- When replacing the batteries, replace both at once with 2 new AA batteries.
- Incorrect battery usage may cause battery fluid leakage and/or damage.
- When not using the remote control for an extended period of time, remove the batteries.
- Avoid dropping or damaging the remote control. Keep remote control away from direct sunlight or heaters.

USING THE REMOTE CONTROL

Proper conditions

- Operate the remote control facing the air cleaner.
- Operate within 6metres of the air cleaner.

Poor conditions that may impair operation

- Any location where there is inverter lighting equipment or electronic spontaneous lighting equipment.
- When objects or furniture are located between remote and air cleaner.
- When air cleaner unit is located in direct sunlight.
- In areas where fluorescent lighting is flickering due to worn-out bulbs.

POWER

Use the POWER button to turn the power on and off. A short "beep" will sound when you turn the unit on or off. Once the unit is on, it will automatically switch into Automatic operation. Turn the unit to manual control by pressing one of the FAN CONTROL buttons.

FAN CONTROL

- UP
Use this button to switch from Automatic operation and increase the fan speed level.
- DOWN
Use this button to decrease the fan speed level.

TURBO

Use this button to switch from Automatic operation and begin the maximum amount of room cleaning and air movement.

PLASMA ON/OFF

Use this button to turn the PLASMAWAVE® generator on or off.



NOTE: This equipment generates, uses, and can radiate radio frequency energy and, if not installed and used in accordance with the instructions, may cause harmful interference to radio communications. However, there is no guarantee that interference will not occur in a particular installation. If this equipment does cause harmful interference to radio or television reception, which can be determined by turning the equipment off and on, the user is encouraged to try to correct the interference through one or more of the following measures:

- Reorient or relocate the receiving antenna.
- Increase the distance between the equipment and receiver.
- Connect the equipment to an outlet on a circuit different from that to which the receiver is connected.
- Consult an experienced radio/TV technician for help.

CARE AND MAINTENANCE

Unit Cleaning

- Clean outside of unit as necessary by wiping with a dry, soft cloth; for stubborn stains, use a warm, damp cloth.
- Do not use volatile fluids such as benzene, paint thinner, or scouring powder, as they may damage the unit surface. Keep the unit dry.
- Clean the wall behind the air outlet periodically, as it may become dirty.

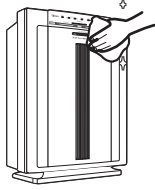

Replacement Procedure

1. Remove the front panel by grasping the bottom outside edges and pulling gently toward you.

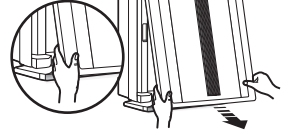

2. Pull out the filter(s) to be changed.

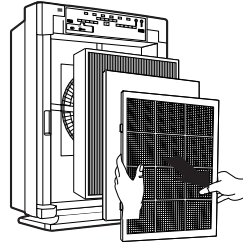

3. Remove any packaging wrap from the new filter(s).

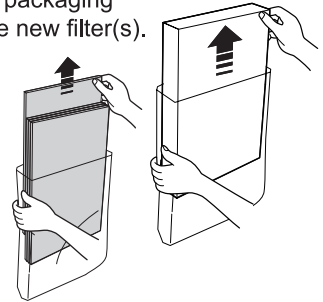

4. Place the new filters in the main unit. (HEPA filter should always be inserted first, then the carbon filter, Pre-filter.)

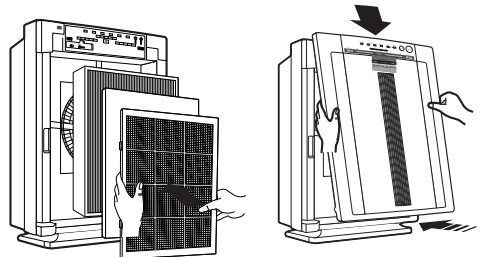

Filter Replacement

- The REPLACEMENT FILTER INDICATOR will signal when to replace the HEPA Filter. The clean/replacement period will vary depending on the hours of usage, air quality and location of the unit. Please note that the carbon filter needs to be changed every 3 months or as needed.
- There are three separate filters: True HEPA, Carbon and Pre Filter
- After changing True HEPA, push reset button on inside of unit – See number 5 instruction to the right.
- For best performance, change the Carbon Filter every three months.

WARNING: Before replacing or cleaning any filters, make sure to remove the power plug from the wall outlet.

NOTE: Do not wash and reuse Carbon Filter, it will not work effectively.

CARE AND MAINTENANCE

5. To reset the filter once a new HEPA filter is installed:
 - a. Plug the unit back in with the front cover off.
 - b. Turn on the unit.
 - c. Locate the filter reset button on the display panel.
 - d. Press and hold the filter reset button for 3-5 seconds. A short beep will be heard and the light should turn off.
 - e. Place the front panel back on the unit and the air cleaner is ready to use.

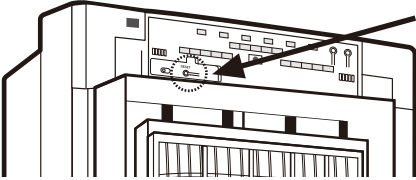

6. Plug in the power cord to a wall outlet and turn on the unit.

TROUBLESHOOTING

Before you call

Solutions to Common Problems

Review this list before you call for service. This list covers problems that are not the result of defective materials or workmanship.

PROBLEM	POSSIBLE SOLUTION
The remote control does not work.	<ul style="list-style-type: none"> • Make sure the remote control batteries are inserted correctly. • Replace worn-out batteries.
The unit leaves smoke and odors in the air.	<ul style="list-style-type: none"> • Make sure the sensor is not blocked or clogged. • Move the unit closer to the offending odors. • Replace filters as needed.
The unit seems to produce odors.	<ul style="list-style-type: none"> • Replace filters as needed. • Clean/Replace filters as needed.
The Air Quality sensor light is green, but the air smells bad.	<ul style="list-style-type: none"> • Clear the Air Quality sensor with a vacuum cleaner, as it may be blocked or clogged. • Compressed air may also be used to blow dust that may be clogging the sensor.
The Air Quality sensor light is orange or red, but the air seems clean.	<ul style="list-style-type: none"> • Clear the Air Quality sensor with a vacuum cleaner, as it may be blocked or clogged.
Unit makes a ticking sound.	<ul style="list-style-type: none"> • This indicates that the PLASMAWAVE® function is working. If the sound is distracting, turn off this function while you are in the room using the remote control.
Unit interferes with radio or television reception.	<ul style="list-style-type: none"> • Because this unit radiates radio frequency energy, we suggest you try one or more of the following: <ul style="list-style-type: none"> - For better reception, adjust the television/radio antenna. - Move the unit away from the affected television/radio. - Plug the unit power cord into an outlet different from the television/radio power cord.
The REPLACE FILTER INDICATOR remains lit after replacing the True HEPA filter.	<ul style="list-style-type: none"> • With the power on, press the FILTER REPLACEMENT RESET button and hold for 5~10 seconds or until the light turns off. • See page 11 instruction 5 for details.

NOTE



This marking shown on the product or its literature, indicates that it should not be disposed with other household wastes at the end of its working life. To prevent possible harm to the environment or human health from uncontrolled waste disposal, please separate this from other types of wastes and recycle it responsibly to promote the sustainable reuse of material resources.

Household users should contact either the retailer where they purchased this product, or their local government office, for details of where and how they can take this item for environmentally safe recycling.

Business users should contact their supplier and check the terms and conditions of the purchase contract. This product should not be mixed with other commercial wastes for disposal.

Distributed by
Ausclimate Pty Ltd

After sales and warranty enquiries, visit website or call 1800 122 100
Website: www.ausclimate.com.au