

Operating and installation instructions Combi steam oven



To avoid the risk of accidents or damage to the appliance it is **essential** to read these instructions before it is installed and used for the first time.

Contents

Warning and Safety instructions	7
Caring for the environment	17
Guide to the appliance	18
Steam oven	18
Accessories supplied	20
Controls	21
On/Off sensor control	22
Display	22
Sensor controls	22
Symbols	24
Using the appliance	25
Selecting a menu option	25
Changing a setting in a list	25
Changing the setting with a segment bar	25
Selecting a function or operating mode	26
Entering numbers	26
Entering letters	26
Activating MobileStart	27
Description of functions	28
Control panel	28
Water container	28
Condensate container	28
Temperature	28
Moisture	28
Cooking duration	29
Noises	29
Heating-up phase	29
Cooking phase	29
Steam reduction	30
Oven interior lighting	30
Before using for the first time	31
Miele@home	31
Basic settings	32
Cleaning for the first time	33
Set the correct boiling point for water	34
Heating up the steam oven	35
Settings	36
Settings overview	36

Opening the “Settings” menu.....	38
Language 	38
Time.....	38
Date.....	39
Lighting.....	39
Display.....	39
Volume.....	40
Units	40
Keeping warm	41
Steam reduction	41
Recommended temperatures.....	42
Booster	42
Water hardness	43
Automatic rinsing	44
Safety	44
Miele@home	45
Remote control.....	46
Activating MobileStart	46
RemoteUpdate	46
Software version.....	47
Showroom programme.....	47
Factory default.....	47
Minute minder	48
Main and sub-menus	50
Energy saving tips	52
Operation	54
Changing values and settings for a cooking programme.....	55
Changing the temperature.....	56
Changing Moisture	56
Setting cooking durations	56
Changing the set cooking durations	57
Deleting the set cooking durations.....	58
Cancelling a cooking programme	58
Interrupting a cooking programme.....	59
Pre-heating the oven compartment	60
Booster.....	60
Pre-heat.....	61
Crisp function	61
Releasing bursts of steam.....	62

Contents

General notes	63
The advantages of cooking with steam	63
Suitable containers.....	63
Shelf level	64
Frozen food.....	64
Temperature	64
Cooking duration	64
Cooking with liquid.....	64
Your own recipes - steam cooking.....	64
Universal tray and combi rack.....	65
Steam cooking	66
Eco Steam cooking	66
Notes on the cooking tables	66
Vegetables.....	67
Fish.....	70
Meat	73
Rice	75
Grain	76
Pasta	77
Dumplings	78
Dried pulses	79
Hen's eggs	81
Fruit	82
Sausages.....	82
Shellfish	83
Mussels	84
Menu cooking (cooking whole meals).....	85
Sous-vide (vacuum) cooking	87
Further applications	95
Reheat	95
Defrost.....	97
Mix & Match	100
Blanching.....	111
Bottling	111
Bottling cakes.....	114
Drying food.....	115
Prove dough	116
Disinfect items	116
Heat crockery	117
Keeping warm	117
Heating damp flannels	118

Dissolve gelatine	118
Decrystallise honey	119
Melt chocolate.....	119
Make yoghurt	120
Cook bacon.....	121
Sweat onions.....	121
Extracting juice with steam	122
Fruit preserve.....	123
Skinning vegetables and fruit.....	124
Apple storage	125
Making eierstich	125
Automatic programmes	126
Categories	126
Using automatic programmes.....	126
Usage notes	126
User programmes.....	127
Baking.....	130
Baking tips.....	130
Tips on baking.....	131
Notes on the functions	131
Roasting	133
Tips for roasting	133
Notes on the functions	133
Grilling	135
Grilling tips	135
Tips for grilling.....	135
Notes on the functions	136
Note for test institutes	137
Cleaning and care	139
Important information on cleaning and care	139
Cleaning the steam oven front	140
PerfectClean.....	141
Oven compartment	142
Cleaning the water container and condensate container.....	143
Accessories	144
Cleaning the side runners.....	145
Lowering the top heat/grill element.....	146

Contents

Maintenance.....	147
Soak	147
Drying.....	147
Rinsing.....	147
Descaling the steam oven	147
Door removal.....	149
Fitting the door	150
Problem solving guide	151
Optional accessories	158
Containers	158
Other.....	158
Cleaning and care products	158
Service.....	159
Contact in the event of a fault	159
Warranty	159
Installation.....	160
Safety instructions for installation	160
Building-in dimensions	161
Installation in a tall unit.....	161
Installation in a base unit.....	162
Side view	163
Swivel range for control panel.....	164
Connection and ventilation.....	165
Installing the steam oven.....	166
Electrical connection	167
Conformity declaration	169

Warning and Safety instructions

The Combi steam oven is referred to in the following instructions as a steam oven.

This steam oven complies with all applicable safety requirements. Inappropriate use can, however, lead to personal injury and material damage.

Read the operating and installation instructions carefully before using the steam oven. They contain important information on safety, installation, use and maintenance. This prevents both personal injury and damage to the steam oven.

In accordance with standard IEC/EN 60335-1, Miele expressly and strongly advises that you read and follow the instructions in the chapter on installing the steam oven as well as the safety instructions and warnings.

Miele cannot be held liable for injury or damage caused by non-compliance with these instructions.

Keep these instructions in a safe place and pass them on to any future owner.

Warning and Safety instructions

Correct application

- ▶ This steam oven is intended for use in domestic households and similar working and residential environments.
- ▶ This steam oven is not intended for outdoor use.
- ▶ The steam oven is intended for domestic use only to steam-cook, bake, roast, grill, defrost and reheat food. All other types of use are not permitted.
- ▶ The steam oven can only be used by people with reduced physical, sensory or mental capabilities, or lack of experience and knowledge, if they are supervised whilst using it, or have been shown how to use it in a safe way and recognise and understand the consequences of incorrect operation.
- ▶ This steam oven is supplied with a special lamp to cope with particular conditions (e.g. temperature, moisture, chemical resistance, abrasion resistance and vibration). This special lamp must only be used for the purpose it is intended for. It is not suitable for room lighting. Replacement lamps may only be fitted by a Miele authorised person or by Miele Service.

Safety with children

- ▶ Activate the system lock to ensure that children cannot switch on the steam oven inadvertently.
- ▶ Children under 8 years of age must be kept away from the steam oven unless they are constantly supervised.
- ▶ Children aged 8 and older may only use the steam oven without supervision if they have been shown how to use it in a safe manner. Children must be able to understand and recognise the possible dangers caused by incorrect operation.
- ▶ Children must not be allowed to clean the steam oven unsupervised.
- ▶ Please supervise children in the vicinity of the steam oven and do not let them play with it.
- ▶ Risk of suffocation due to packaging material. Whilst playing, children may become entangled in packaging material (such as plastic wrapping) or pull it over their head, presenting the risk of suffocation. Keep packaging material away from children.
- ▶ Risk of injury caused by hot surfaces. Children's skin is far more sensitive to high temperatures than that of adults. External parts of the steam oven such as the door glass, control panel and the vent become quite hot. Do not let children touch the steam oven when it is in operation.
Keep children well away from the steam oven until it has cooled down and there is no danger of injury.
- ▶ Risk of injury from the open door.
The oven door can support a maximum weight of 10 kg. Children could injure themselves on an open door.
Do not let children sit on the open door, lean against it or swing on it.

Warning and Safety instructions

► If you touch the  sensor control, the door will fully open automatically. In doing so, it can knock against small children or animals, for example.

If the buzzers are switched on, a buzzer will sound on the steam oven when you open the door via remote control using a voice-based service. When opening the door, make sure that nobody is in the area around the door. Make sure that you keep the buzzers switched on.

Technical safety

- ▶ Unauthorised installation, maintenance and repairs can cause considerable danger for the user. Installation, maintenance and repairs must only be carried out by a Miele authorised technician.
- ▶ Never use a damaged steam oven. It could be dangerous. Check it for visible signs of damage before using it.
- ▶ Reliable and safe operation of this steam oven can only be assured if it has been connected to the mains electricity supply.
- ▶ The electrical safety of this appliance can only be guaranteed when correctly earthed. It is essential that this standard safety requirement is met. If in any doubt please have the electrical installation tested by a qualified electrician.
- ▶ Before connecting the appliance to the mains supply, ensure that the connection data on the data plate (voltage and frequency) match the mains electricity supply.
This data must correspond in order to avoid the risk of damage to the appliance. Consult a qualified electrician if in any doubt.
- ▶ Do not connect the steam oven to the mains electricity supply by a multi-socket adapter or an extension lead. These do not guarantee the required safety of the appliance (fire hazard).
- ▶ For safety reasons, this steam oven may only be used when it has been built in. This is necessary to ensure that all electrical components are shielded.
- ▶ This steam oven must not be used in a non-stationary location (e.g. on a ship).
- ▶ Risk of injury due to electric shock. Any contact with live connections or tampering with the electrical or mechanical components of the oven will endanger your safety and may lead to the steam oven malfunctioning.
Do not open the steam oven housing under any circumstances.

Warning and Safety instructions

- ▶ While the appliance is under warranty, repairs should only be undertaken by a Miele authorised service technician. Otherwise the warranty is invalidated.
- ▶ Miele can only guarantee the safety of the appliance when genuine original Miele replacement parts are used. Faulty components must only be replaced by Miele spare parts.
- ▶ If the plug is removed from the connection cable or if the cable is supplied without a plug, the appliance must be connected to the electrical supply by a suitably qualified electrician.
- ▶ If the mains connection cable is damaged, it must be replaced with a special mains connection cable (see “Electrical connection” in the “Installation” chapter).
- ▶ During installation, maintenance and repair work, the appliance must be disconnected from the mains electricity supply.
- ▶ If the steam oven is installed behind a furniture front (e.g. a door), do not close the furniture front while the steam oven is in use. Heat and moisture can build up behind the furniture front when closed. This can result in damage to the steam oven, the housing unit and the floor. Leave the furniture door open until the steam oven has cooled down completely.
- ▶ In areas which may be subject to infestation by cockroaches or other vermin, pay particular attention to keeping the appliance and its surroundings clean at all times. Any damage caused by cockroaches or other vermin will not be covered by the warranty.

Correct use

▶ Risk of injury caused by hot surfaces and steam. The steam oven gets hot during operation. You could burn yourself on the heater elements, oven compartment, side runners, accessories, door glass, food or steam.

Wear oven gloves when placing hot food in the oven or removing it, when adjusting oven shelves etc. in a hot oven compartment and when closing the door.

▶ Risk of injury caused by hot food.

Food may spill or splash around when placing it into the oven or removing it. The food can cause burns.

When placing cooking containers into the oven or removing them, make sure that the hot food does not spill.

▶ Do not use the steam oven to heat up or bottle food in sealed jars and tins.

Pressure will build up inside them and they can explode causing damage to the appliance, as well as the risk of injury and scalding.

▶ Plastic containers which are not suitable for use in an oven melt at high temperatures and can damage the steam oven or catch fire.

Only use plastic containers which are declared by the manufacturer as being suitable for use in an oven. Follow the manufacturer's instructions on use. If you want to use plastic containers for steaming food make sure that they are temperature resistant to 100 °C and steam resistant. Any other plastic containers could melt, become brittle or break when subjected to heat.

▶ Food which is stored in the oven compartment can dry out and the moisture released can lead to corrosion damage in the steam oven. Do not leave food in the oven compartment and do not use any cooking containers which are susceptible to corrosion.

▶ Risk of injury from the open door. You could bang into the open door or trip over it. Avoid leaving the door open unnecessarily.

Warning and Safety instructions

- ▶ The door can support a maximum weight of 10 kg. Do not sit on or lean against an open door, and do not place heavy objects on it. Also make sure that nothing can get trapped between the door and the oven cavity. The steam oven could get damaged.
- ▶ Oil and fat can ignite if overheated. Never leave the steam oven unattended when cooking with oil and fat. If it does ignite do not put the flames out with water. Switch the steam oven off immediately and then suffocate the flames by keeping the oven door closed.
- ▶ Due to the high temperatures radiated, objects left near the steam oven when it is in use could catch fire. Do not use the steam oven to heat up the room.
- ▶ Grilling food for excessively long cooking durations can cause it to dry out with the risk of catching fire. Do not exceed the recommended cooking durations.
- ▶ Certain foods dry out quickly and may catch fire due to high grill temperatures. Never use grill modes to finish baking partially baked rolls or bread or to dry flowers or herbs. Use the Fan plus  or Conventional heat functions instead.
- ▶ To avoid fuelling any flames, do not open the steam oven door if there is smoke inside the oven compartment. Interrupt operation by switching the steam oven off and disconnecting it from the mains electricity supply. Do not open the door until the smoke has dispersed.
- ▶ If using alcohol in your recipes, please be aware that high temperatures can cause the alcohol to vaporise. The vapour can catch fire on hot heating elements.

Warning and Safety instructions

▶ Never line the floor of the oven compartment with aluminium foil or oven liners. Do not place any crockery or any pans, pots or baking trays directly on the floor of the oven compartment.

If you want to use the floor of the oven compartment as an extra surface, place the rack on the floor of the oven compartment with the rack surface facing up and the cooking container on top. In doing so, ensure that the filter in the floor of the oven is not moved.

▶ The oven compartment floor can become damaged by the rack being pushed around on it.

Do not push the rack around on the oven compartment floor.

▶ Larger deposits of food can block the drain and pump. Always make sure that the filter in the floor of the oven is inserted.

▶ When using a small electrical appliance, e.g. a hand-held blender, near the steam oven, care should be taken that the cable of the appliance cannot get trapped by the steam oven door. The insulation on the cable could become damaged, giving rise to an electric shock hazard.

▶ Do not operate the steam oven without the lamp cover. Steam could reach electrical components and cause a short circuit. Steam could also damage the electrical components.

Warning and Safety instructions

Cleaning and care

- ▶ Risk of injury due to electric shock. The steam from a steam cleaning appliance could reach live electrical components and cause a short circuit. Do not use a steam cleaner to clean the appliance.
- ▶ Scratches on the door glass can result in the glass breaking. Do not use abrasive cleaners, hard sponges, brushes or sharp metal tools to clean the door glass.
- ▶ The side runners can be removed (see “Cleaning and care – Cleaning the side runners”).
Refit the side runners correctly.
- ▶ Try to avoid the interior walls being splashed with food or liquids containing salt. If it does happen, wipe these away thoroughly to avoid corrosion to stainless steel surfaces inside the cabinet.

Accessories

- ▶ Only use genuine original Miele accessories and spare parts with this appliance. Using accessories or spare parts from other manufacturers will invalidate the warranty and Miele cannot accept liability.

Disposal of the packing material

The packaging is designed to protect the appliance from damage during transportation. The packaging materials used are selected from materials which are environmentally friendly for disposal and should be recycled.

Recycling the packaging reduces the use of raw materials in the manufacturing process and also reduces the amount of waste in landfill sites.

Disposing of your old appliance

Electrical and electronic appliances often contain valuable materials. They also contain specific materials, compounds and components, which were essential for their correct function and safety. These could be hazardous to human health and to the environment if disposed of with your domestic waste or if handled incorrectly. Please do not, therefore, dispose of your old appliance with your household waste.



Please dispose of it at your local community waste collection / recycling centre for electrical and electronic appliances, or contact your dealer or Miele for advice. You are also responsible for deleting any personal data that may be stored on the appliance being disposed of. Please ensure that your old appliance poses no risk to children while being stored prior to disposal.

Guide to the appliance

Steam oven

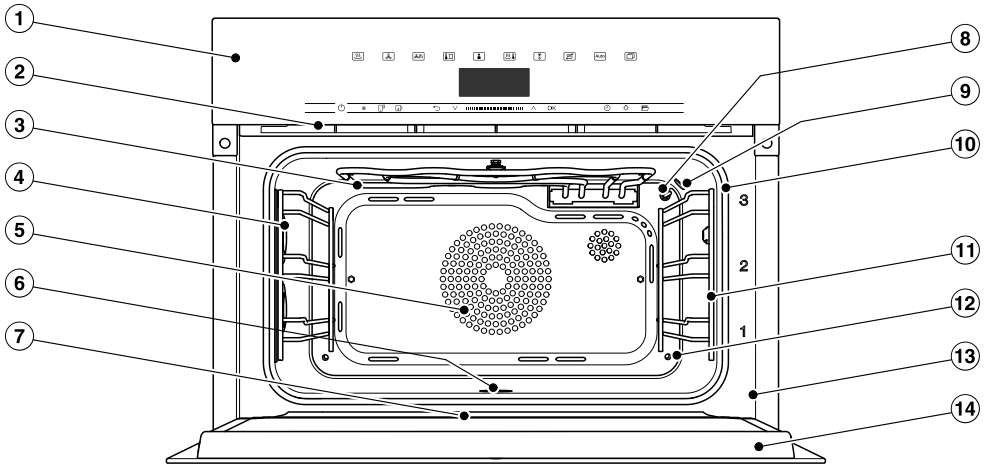

- ① Control elements
- ② Ventilation outlet
- ③ Top heat/grill element
- ④ Oven interior lighting
- ⑤ Air inlet for the fan with ring heating element behind it
- ⑥ Oven compartment floor with bottom heater element and floor filter underneath it
- ⑦ Drip channel
- ⑧ Temperature sensor
- ⑨ Moisture sensor
- ⑩ Door seal
- ⑪ Side runners with 3 shelf levels
- ⑫ Steam inlet
- ⑬ Front frame with data plate
- ⑭ Door

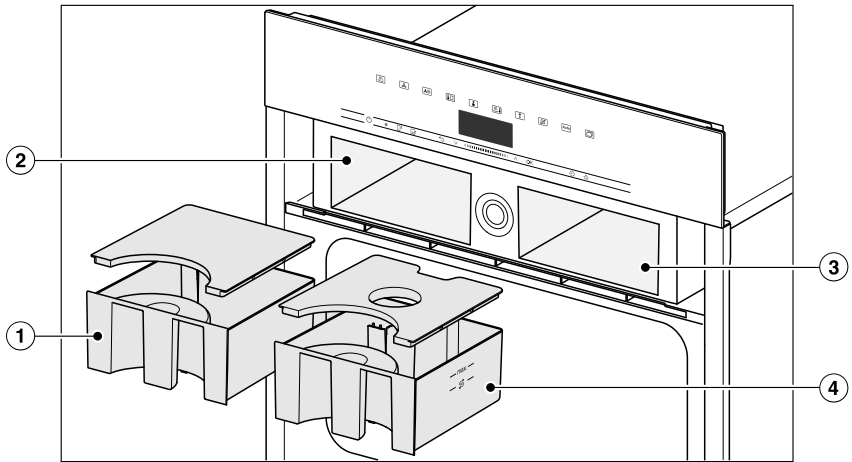

- ① Condensate container
- ② Condensate container compartment
- ③ Compartment for water container
- ④ Water container

Guide to the appliance

A list of the models described in these operating and installation instructions can be found on the back page.

Data plate

The data plate is located on the front frame, visible when the door is open.

The data plate states the model number, the serial number as well as connection data (voltage, frequency and maximum rated load).

Please have this information to hand, should you need to contact Miele regarding any questions or problems.

Accessories supplied

The accessories supplied with your appliance as well as a range of optional ones are available to order from Miele (see "Optional accessories").

DGG 20

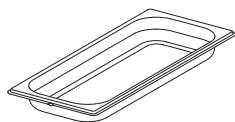

1 solid cooking container
Gross capacity 2.4 l / Usable capacity 1.8 l
450 x 190 x 40 mm (W x D x H)

DGGL 20

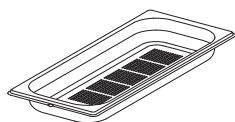

1 perforated cooking container
Gross capacity 2.4 litres / Usable capacity 1.8 litres
450 x 190 x 40 mm (W x D x H)

Universal tray

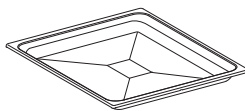

1 universal tray for baking, roasting and grilling

Combi rack



1 combi rack for baking, roasting and grilling

Opener



For manually opening the door







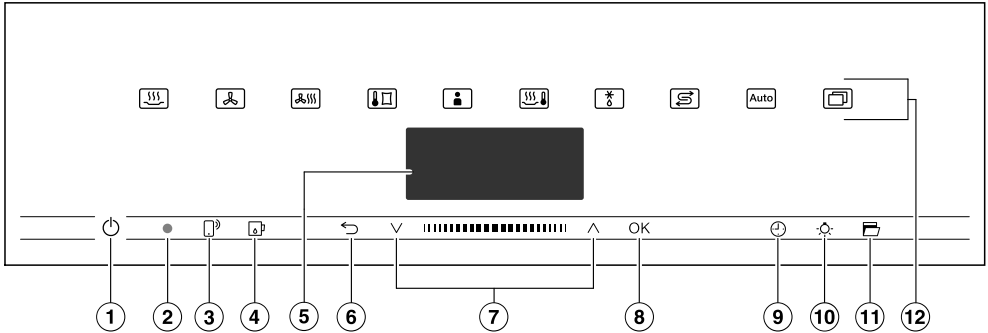

DGCLean

Special cleaning agent for removing stubborn soiling from the oven compartment, particularly after roasting.

Descaling tablets

For descaling the appliance



- ① Recessed  On/Off sensor control
For switching the steam oven on and off
- ② Optical interface
(For Miele Service only)
- ③  sensor control
For controlling the steam oven via your mobile device
- ④ Sensor control 
For opening and closing the control panel
- ⑤ Display
For displaying the time of day and information on operation
- ⑥  sensor control
For going back a step and for changing menu options during a cooking programme
- ⑦ Navigation area with  and  arrow buttons
For scrolling through lists and for changing values
- ⑧ **OK** sensor control
For selecting functions and saving settings
- ⑨  sensor control
For setting a minute minder, the cooking duration or the start or end time for the cooking programme
- ⑩  sensor control
For switching the oven interior lighting on and off
- ⑪  sensor control
For opening the door
- ⑫ Sensor controls
For selecting functions, automatic programmes and settings

Controls

On/Off sensor control

The  On/Off sensor control is recessed and reacts to touch.

Use this sensor control to switch the steam oven on and off.

Display

The display is used for showing the time of day or information about functions, temperatures, cooking durations, automatic programmes and settings.

After switching the steam oven on with the  On/Off sensor control, the main menu will appear, prompting you to Select function.

Sensor controls





The sensor controls react to touch. Every touch of a sensor is confirmed with an audible keypad tone. You can turn this keypad tone off using Further  | Settings | Volume | Keypad tone.

If you want the sensor controls to respond even when the steam oven is switched off, select the Display | Quick-Touch | On setting.



Sensor controls above the display

For information on the functions and operating modes, see “Main and sub-menus”, “Settings”, “Automatic programmes” and “Further applications”.

Sensor controls under the display





Sensor control	Function
	<p>If you want to control the steam oven from your mobile device, you must have the Miele@home system, switch on the Remote control setting and touch this sensor control. The sensor control then lights up orange and the MobileStart function is available.</p> <p>As long as this sensor control is lit, you can control the steam oven via your mobile device (see “Settings – Miele@home”).</p>
	<p>Use this sensor control to open and close the control panel (see “Control panel” in the “Functional description” chapter).</p>
	<p>Depending on which menu you are in, this sensor control will take you back a level or back to the main menu.</p> <p>If a cooking programme is in progress at the same time, use this sensor control to change values and settings such as the temperature or booster function for the programme, or to cancel the programme.</p>
	<p>In the navigation area, use the arrow buttons or the area between them to scroll up or down in the selection lists. The menu options will be highlighted one after the other as you scroll through them. The desired menu option must be highlighted before you can select it.</p> <p>You can change the values or settings that are highlighted by using the arrow buttons or the area between them.</p>
<p>OK</p>	<p>Functions highlighted in the display can be selected by touching the OK sensor control. The selected function can then be changed.</p> <p>Confirm with OK to save changes.</p> <p>If information appears in the display, select OK to confirm the message.</p>

Controls

Sensor control	Function
	<p>If no cooking programme is in progress, you can use this sensor control to set a minute minder (e.g. when boiling eggs) at any point.</p> <p>If a cooking programme is in progress at the same time, you can set a minute minder, the cooking duration and a start or end time for the programme.</p>
	<p>Select this sensor control to switch the oven interior lighting on and off.</p> <p>Depending on the setting selected, the oven interior lighting switches off after 15 seconds or remains constantly switched on or off.</p>
	<p>Use this sensor control to open the door automatically. To close it, press against the door frame with your hand or with a suitable pot holder or oven glove until the door shuts.</p>

Symbols

The following symbols may appear in the display:

Symbol	Meaning
	This symbol indicates that there is additional information and advice about using the appliance. Press the <i>OK</i> sensor control to confirm the information.
	Minute minder
	A tick indicates the option which is currently selected.
	Some settings, e.g. display brightness and buzzer volume are selected using a bar chart.

Use the \wedge and \vee arrow buttons or the **|||||** area between them in the navigation area to use the steam oven.

As soon as you reach a value, message or setting you need to confirm, the *OK* sensor control will light up orange.

Selecting a menu option

- Touch the \wedge or \vee arrow buttons or swipe to the right or left in the **|||||** area until the desired menu option is highlighted.

Tip: If you press and hold the arrow button, the list continues scrolling automatically until you release the arrow button.

- Confirm your selection with *OK*.

Changing a setting in a list

- Touch the \wedge or \vee arrow buttons or swipe to the right or left in the **|||||** area until you reach the desired value or the desired setting is highlighted.

Tip: A \checkmark tick will appear beside the current setting.

- Confirm with *OK*.

The setting is now saved. This will take you back to the previous menu.

Changing the setting with a segment bar

Some settings are represented by a bar **■■■■■□□□** with seven segments. If all of the segments are illuminated, the maximum value is selected.

If none of the segments are illuminated, or only one of them is, the minimum value is selected or the setting is switched off altogether (e.g. volume).

- Touch the \wedge or \vee arrow buttons or swipe to the right or left in the **|||||** area until you reach the desired setting.

- Confirm your selection with *OK*.

The setting is now saved. This will take you back to the previous menu.

Using the appliance

Selecting a function or operating mode

The sensor controls for the functions and operating modes (e.g. Further ) are located above the display (see “Controls” and “Settings”).

- Touch the sensor control for the desired function.

The sensor control on the fascia panel lights up orange.

- Under Further , scroll through the lists until the desired menu option is highlighted.
- Set the values for the cooking programme.
- Confirm with *OK*.

Changing the function

You can change to another function during a cooking programme.

The sensor control for the previously selected function lights up orange.

- Touch the sensor control of the new function or operating mode.

The new function appears in the display with its corresponding recommended values.

The sensor control for the new function lights up orange.

Under Further , scroll through the lists until you reach the desired menu option.

Entering numbers

Numbers that can be changed are highlighted.

- Touch the \wedge or \vee arrow buttons or swipe to the right or left in the **|||||** area until the desired number is highlighted.

Tip: If you press and hold an arrow button, the numbers continue scrolling automatically until you release the arrow button.

- Confirm with *OK*.

The changed number is now saved. This will take you back to the previous menu.

Entering letters

Letters are entered via the navigation area. It is best to select short names.

- Touch the \wedge or \vee arrow buttons or swipe to the right or left in the **|||||** area until the desired character is highlighted.

The character you have selected will appear in the top line of the display.

Tip: A maximum of 10 characters can be used.

You can delete the characters one at a time with \leftarrow .

- Select the rest of the characters.
- Once you have entered the name, select \checkmark .
- Confirm with *OK*.

The name is now saved.

Activating MobileStart

- Select the  sensor control to activate MobileStart.

The  sensor control lights up. You can operate your steam oven remotely with the Miele@mobile app.

Directly operating the steam oven takes priority over operating it via the remote control function on the app.

You can use MobileStart as long as the  sensor control is lit up.

Description of functions

Control panel

The water container and the condensate container are located behind the control panel. The panel is opened and closed by pressing the  sensor control. It is fitted with anti-trapping protection. If the panel senses resistance when opening/closing, the process is cancelled.

Water container

The maximum filling volume is 1.4 l and the minimum is 1.0 l. There are markings on the water container. The upper marking must never be exceeded.

Water consumption depends on the type of food and the cooking duration. The water may need to be topped up during cooking. Water consumption is increased if the door is opened during cooking.

Fill the water container to the maximum level before each cooking programme involving steam.



Condensate container

Condensate that collects in the appliance from cooking is pumped into the condensate container. The container has a maximum capacity of 1.4 litres.

Temperature

Some functions have a pre-set recommended temperature. This temperature can be altered for a single programme, a specific programme stage or within the given range for a programme. You can alter the recommended temperature in 5 °C increments, or 1 °C increments in sous-vide cooking (see “Settings – Recommended temperatures”).

Moisture

The Combi mode  function and Re-heat  application use a combination of oven heat and moisture. The moisture level can be selected within the given range for an individual programme or a specific programme stage.

Depending on the moisture setting, moisture or fresh air is supplied to the oven compartment. When the moisture setting = 0 %, the maximum fresh air supply is implemented and no moisture is supplied. When the moisture setting = 100 %, there is no fresh air supply and the moisture content is at its maximum.

Some food gives off moisture during the cooking process. This moisture from the food affects the amount of additional moisture needed. If the required amount of moisture is low, the steam generator may not be activated at all.

Cooking duration

Depending on the function, you can set a cooking duration of between 1 minute and 10 or 12 hours.

The cooking durations of the automatic and maintenance programmes are set at the factory and cannot be altered.

When cooking with steam, as well as for programmes and applications with pure steam operation, the cooking duration does not begin until the set temperature is reached. It starts immediately for all other functions, programmes and applications.

Noises

A humming sound can be heard during operation and after switching off the steam oven. This noise does not indicate incorrect operation or an appliance fault. The noise is made by water being pumped through the system.

When the steam oven is in use, you will hear a fan noise.

Heating-up phase

In all functions, the display shows the temperature in the oven compartment as it rises during the heating-up phase (exceptions: Full grill, Economy grill).

When cooking with steam, the duration of the heating-up phase will depend on the quantity and the temperature of the food. In general, the heating-up phase will last for approx. 7 minutes. The duration will be longer if you are cooking refrigerated or frozen food. The heating-up phase may also last longer if cooking temperatures are low or if you are using the Sous-vide  cooking function.

Cooking phase

The cooking phase begins when the set temperature is reached. During the cooking phase, the duration remaining will be shown in the display.

Description of functions

Steam reduction

With steam cooking and combination cooking, the steam reduction function will switch on automatically at the end of a cooking programme which uses a temperature within a certain temperature range. The function stops excessive steam escaping when the door is opened. Steam reduction will appear in the display.

Steam reduction can be switched off (see “Steam reduction” in the “Settings” chapter). With steam reduction switched off, a lot of steam will escape when the door is opened.

Oven interior lighting

For energy-saving reasons, the oven interior lighting has been set at the factory to go out after the programme has begun.

If you want it to stay on all the time the oven is on, you will need to alter the default setting (see “Settings – Lighting”).

If the door is left open at the end of a cooking programme, the oven interior lighting will switch off automatically after 5 minutes.

The lighting can be switched on for 15 seconds by touching the  button on the control panel.

Before using for the first time

Miele@home

Your steam oven is equipped with an integrated WiFi module.

In order to use it, you will need:

- a WiFi network,
- the Miele@mobile app, and
- a Miele user account, which can be created from the Miele@mobile app.

The Miele@mobile app will guide you as you connect your steam oven to your home WiFi network.

Once your steam oven is connected to your WiFi network, you can use the app for a number of actions, including the following:

- Getting information on the operating status of your steam oven
- Retrieving information on your steam oven's current cooking programmes
- Stopping cooking programmes that are in progress

Connecting your steam oven to your WiFi network will increase energy consumption, even when the steam oven is switched off.

Make sure that the signal of your WiFi network is sufficiently strong in the place where your steam oven is installed.

Availability of the WiFi connection

The WiFi connection shares a frequency range with other appliances (including microwave ovens and remote control toys). This can give rise to sporadic or even complete connection failures. Therefore, the availability of featured functions cannot be guaranteed.

Miele@home availability

The ability to use the Miele@mobile app depends on the availability of the Miele@home service in your country.

The Miele@home service is not available in every country.

For information about availability, please visit www.miele.com.

Miele@mobile App

The Miele@mobile App is available to download free of charge from the Apple App Store® or from the Google Play Store™.



Before using for the first time

Basic settings

The following settings must be made before starting up for the first time. You can change these settings again at a later time (see “Settings”).

 Risk of injury caused by hot surfaces.

The steam oven gets hot during operation.

For safety reasons, the steam oven may only be used when it has been fully installed.

The steam oven will switch on automatically when it is connected to the electricity supply.

Setting the language

- Select the desired language.
- Confirm with *OK*.

If you have selected the wrong language by mistake, proceed as described in “Settings –  Language”.

Setting the location

- Select the desired location.
- Confirm with *OK*.

Setting up Miele@home

Set up “Miele@home” will appear in the display.

- To set up Miele@home now, select *Continue* and confirm with *OK*.
- To set it up at a later date, select *Skip* and confirm with *OK*. See “Settings – Miele@home” for information on setting up at a later date.
- To set up Miele@home now, select the desired connection method.

You will then be guided by the display and the Miele@mobile app.

Setting the date

- Set the year, then the month, and finally the day.
- Confirm with *OK*.

Setting the time

- Set the time of day in hours and minutes.
- Confirm with *OK*.

Before using for the first time

Setting the water hardness level

Contact your local water supplier to find out the hardness of the water in your area.

More information can be found under “Settings – Water hardness”.

- Select your local water hardness on the appliance.
- Confirm with *OK*.

Completing the commissioning process

- Follow any further instructions in the display.

The oven is now ready for use.

Cleaning for the first time

- Remove any protective wrapping and stickers from the steam oven and accessories.



The appliance has undergone a function test in the factory. Residual water from this testing may have trickled back into the cabinet during transportation.

Cleaning the water container and condensate container

 Risk of injury caused by control panel.

You could get caught in the panel as it opens or closes.

Do not touch the upper edge of the door when the panel is opening and closing.

- Switch the steam oven on using the On/Off  button.
- Select the  sensor control to open the control panel.
- Remove the water container and condensate container. Remove the water container and condensate container by pushing it upwards slightly.
- Rinse the water container and condensate container by hand or in the dishwasher.

Before using for the first time

Cleaning accessories/oven compartment

- Take all accessories out of the oven compartment.
- Wash the cooking containers by hand or in the dishwasher.

The universal tray and combi rack surfaces are treated with PerfectClean and must **only** be washed by hand. See “PerfectClean” in the “Cleaning and care” chapter.

- Clean the universal tray and the combi rack with a clean sponge and a solution of hot water and washing-up liquid.

The interior of the steam oven has been treated at the factory with a conditioning agent.

- To remove this, clean the oven compartment with a clean sponge and a mild solution of washing-up liquid and hot water.

Set the correct boiling point for water

Before cooking food for the first time, you must adjust the steam oven to the boiling temperature of the water, which varies depending on the altitude of where the steam oven is located. This process also flushes out the components of the appliance that carry water.

This procedure **must** be carried out to ensure trouble-free functioning of your appliance.

Distilled water, carbonated water and other liquids may damage the steam oven.

Only use cold, fresh tap water (below 20 °C).

- Remove the water container and fill it up to the maximum marker.
- Push the water container into the appliance.
- Then run the steam oven for 15 minutes using the Steam cooking  function (100 °C). Proceed as described in “Operation”.

Setting the correct boiling point for water following a house move

If you move house, the boiling point for the water in the steam oven will need to be re-set for the new altitude if this differs from the old one by 300 m or more. To do this, descale the appliance (see “Care” in the “Cleaning and care” chapter).

Heating up the steam oven

- Take all accessories out of the oven compartment if applicable.
- To remove the grease from the ring heating element, heat the steam oven up at 200 °C using the Fan plus  function for 30 minutes. Proceed as described in the “Operation” chapter.

 Risk of injury caused by hot surfaces.

The steam oven gets hot during operation. You could burn yourself on the heater elements, oven compartment, side runners or door glass.





Wear oven gloves when adjusting oven shelves etc. in a hot oven compartment and when closing the hot door.

The heater element will give off a slight smell when it is heated for the first time. The smell and any vapours given off will dissipate after a while and do not indicate a faulty connection or appliance.

Ensure that the kitchen is well ventilated during this operation.

Settings

Settings overview

Menu option	Available settings
Language 	... deutsch english ... Location
Time	Show On* Off Night dimming Clock format 12 h 24 h* Set
Date	
Lighting	On "On" for 15 seconds* Off
Display	Brightness  QuickTouch On Off*
Volume	Buzzer tones Melodies*  Solo tone  Keypad tone  Welcome melody On* Off
Units	Weight g* lb/oz lb Temperature °C* °F
Keeping warm	On Off*
Steam reduction	On* Off
Recommended temperatures	
Booster	On* Off
Water hardness	1 °dH ... 15 °dH* ... 70 °dH



* Factory default setting

Menu option	Available settings
Automatic rinse	On* Off
Safety	Sensor lock On Off* System lock  On Off*
Miele@home	Activate Deactivate Connection status Set up again Reset Set up
Remote control	On* Off
RemoteUpdate	On* Off
Software version	
Showroom programme	Demo mode On Off*
Factory default	Appliance settings User programmes Recommended temperatures

* Factory default setting

Settings

Opening the “Settings” menu

In the Further  | Settings  menu, you can personalise your steam oven by adapting the factory default settings to suit your requirements.

- Select Further .
- Select Settings .
- Select the desired setting.



You can check settings or change them.

Settings cannot be changed while a cooking programme is in progress.

Language

You can set the desired language and location.

After selecting and confirming your choice, the language you have selected will appear in the display.

Tip: If you have selected the wrong language by mistake, select the  sensor control. Follow the  symbol to get back to the Language  sub-menu.

Time

Show

Select how you want the time of day to show in the display when the steam oven is switched off:

- On
The time is always visible on the display.
If you also select the Display | Quick-Touch | On setting, all sensor controls react to touch straight away.
If you also select the Display | Quick-Touch | Off setting, the steam oven has to be switched on before it can be used.
- Off
To save energy, the display does not light up. The steam oven has to be switched on before it can be used.
- Night dimming
To save energy the time only shows in the display between 05:00 and 23:00. The display remains dark at all other times.

Clock format

The time of day can be displayed in the 24 or 12-hour format (24 h or 12 h).

Set

Set the hours and the minutes.



If there is a power cut, the current time of day will reappear once power has been restored. The time of day is saved for approx. 150 hours.

If the steam oven has been connected to a WiFi network and signed into the Miele@mobile app, the time will be synchronised based on the location setting in the Miele@mobile app.

Date

Set the date.



Lighting

- On
The oven interior lighting is switched on during the entire cooking period.
- "On" for 15 seconds
The oven interior lighting switches off 15 seconds after a cooking programme has begun. Press the  sensor control to switch the oven interior lighting on again for 15 seconds.
- Off
The oven interior lighting is switched off. Press the  sensor control to switch on the oven interior lighting for 15 seconds.

Display

Brightness

The display brightness is represented by a bar with seven segments.

- 
Maximum brightness
- 
Minimum brightness

QuickTouch

Select how the sensor controls should respond when the steam oven is switched off:

- On
If you have also selected the Time | Show | On or Night dimming setting, the sensor controls will also respond when the steam oven is switched off.
- Off
Independently of the Time | Show setting, the sensor controls only respond when the steam oven is switched on, as well as for a certain amount of time after switching it off.

Settings

Volume

Buzzer tones



If buzzers are switched on, a buzzer will sound when the set temperature is reached and at the end of a set time.

If you want to open the door remotely using a voice-based service, make sure that nobody is in the area around the door when opening it. Make sure that you keep the buzzers switched on.

Melodies

At the end of a process, a melody will sound several times in intervals.



The volume of the melody is represented by a bar with seven segments.

-  Maximum volume
-  Melody is switched off

Solo tone



At the end of a process, a continuous tone will sound for a period of time.

The pitch of this continuous tone is represented by a segment bar.

-  Maximum pitch
-  Minimum pitch

Keypad tone

The volume of the tone that sounds each time you touch a sensor control is represented by a bar with seven segments.

-  Maximum volume
-  Tone is switched off

Welcome melody

The melody that sounds when you touch the  On/Off sensor control can be switched on or off.

Units

Weight

For automatic programmes, you can set the weight of food in grams (g), pounds/ounces (lb/oz) or pounds (lb).

Temperature

You can set the temperature in degrees Celsius (°C) or degrees Fahrenheit (°F).

Keeping warm

Using the Keeping warm function, you can keep food warm at the end of a steam cooking programme. Food is kept warm at a pre-set temperature for a maximum of 15 minutes. You can cancel the keeping warm process by opening the door.

Please note that delicate food, especially fish, can continue cooking whilst being kept warm.

- On
The Keeping warm function is switched on. When cooking with a temperature of approx. 80 °C or above, this function is active after approx. 5 minutes. The food is kept warm at a temperature of 70 °C.
- Off
The Keeping warm function is switched off.

Steam reduction

The Steam reduction function stops excessive steam escaping when the door is opened.

- On
The steam reduction function will switch on automatically at the end of a cooking programme which uses a temperature of over approx. 80 °C (steam cooking) or 80–100 °C and 100 % moisture (combination cooking). Steam reduction will appear on the display.
- Off
If steam reduction is switched off, the Keeping warm function is also automatically switched off. With steam reduction switched off, a lot of steam will escape when the door is opened.

Settings

Recommended temperatures

If you often cook with different temperatures, it makes sense to change the recommended temperatures.

After selecting this menu option, a list of functions will appear in the display.

- Select the desired function.

The recommended temperatures are displayed along with the available temperature range.

- Change the recommended temperatures.
- Confirm with *OK*.

Booster

The **Booster** function is used to quickly pre-heat the oven compartment.

- On
The **Booster** function is automatically switched on during the heating-up phase of a cooking programme. The top heat/grill element, ring heating element and hot air fan pre-heat the oven compartment to the set temperature at the same time.
- Off
The **Booster** function is switched off during the heating-up phase of a cooking programme. Only the heating elements for the selected oven function are used to pre-heat the oven compartment.

Water hardness

The steam oven must be adjusted to the local water hardness level to ensure that it works correctly and to ensure that descaling is carried out at the correct interval. The harder the water is, the more frequently the steam oven needs to be descaled.

Contact your local water supplier to find out the hardness of the water in your area.

If you use bottled water, such as mineral water, make sure it is not carbonated. Adjust this setting depending on the calcium content. The calcium content is specified on the label of the bottle in mg/l Ca²⁺ or ppm (mg Ca²⁺/l).

You can set the hardness level between 1 °dH and 70 °dH. The hardness level is set to 15 °dH by default.

- Select your local water hardness on the appliance.
- Confirm with OK.

Water hardness		Calcium content mg/l Ca ²⁺ or ppm (mg Ca ²⁺ /l)	Setting
°dH	mmol/l		
1	0.2	7	1
2	0.4	14	2
3	0.5	21	3
4	0.7	29	4
5	0.9	36	5
6	1.1	43	6
7	1.3	50	7
8	1.4	57	8
9	1.6	64	9
10	1.9	71	10

Water hardness		Calcium content mg/l Ca ²⁺ or ppm (mg Ca ²⁺ /l)	Setting
°dH	mmol/l		
11	2.0	79	11
12	2.2	86	12
13	2.3	93	13
14	2.5	100	14
15	2.7	107	15
16	2.9	114	16
17	3.1	121	17
18	3.2	129	18
19	3.4	136	19
20	3.6	143	20
21	3.8	150	21
22	4.0	157	22
23	4.1	164	23
24	4.3	171	24
25	4.5	179	25
26	4.7	186	26
27	4.9	193	27
28	5.0	200	28
29	5.2	207	29
30	5.4	214	30
31	5.6	221	31
32	5.8	229	32
33	5.9	236	33
34	6.1	243	34
35	6.3	250	35
36	6.5	257	36
37–45	6.6–8.0	258–321	37–45
46–60	8.2–10.7	322–429	46–60
61–70	10.9–12.5	430–500	61–70

Settings

Automatic rinsing

Following a cooking programme with steam, *Appliance rinsing* will appear on the display after the steam oven has been switched off.

This process flushes any remaining food deposits out of the system.

You can activate or deactivate the automatic rinsing process.

Safety

Sensor lock

The sensor lock prevents the cooking programme being switched off by mistake or settings being changed. Apart from the  On/Off sensor control, the activated sensor lock prevents the sensor controls and fields in the display from working a few seconds after a programme has been started.

- On
The sensor lock is activated. Touch the *OK* sensor control for at least 6 seconds to deactivate the sensor lock for a short period of time.
- Off
The sensor lock is deactivated. All sensor controls react to touch as normal.

System lock

The system lock prevents the steam oven being switched on by mistake.

The minute minder and the MobileStart function can still be used when the system lock is active.

The system lock will remain activated even after a mains outage.

- On
The system lock has been activated. Before you can use the steam oven, touch the *OK* sensor control for at least 6 seconds.
- Off
The system lock is deactivated. You can use the steam oven as normal.

Miele@home

The steam oven is a Miele@home-compatible appliance. Your steam oven is fitted ex-works with a WiFi communication module and is suitable for wireless communication.

There are a number of ways of connecting your steam oven to your WiFi network. We recommend connecting your steam oven to your WiFi network using the Miele@mobile App or via WPS.

- Activate
This setting is only visible if Miele@home is deactivated. The WiFi function is reactivated.
- Deactivate
This setting is only visible if Miele@home is activated. Miele@home remains set up, the WiFi function is switched off.
- Connection status
This setting is only visible if Miele@home is activated. The display shows information such as the WiFi reception quality, network name and IP address.
- Set up again
This setting is only visible if a WiFi network has already been set up. Reset the network settings and immediately set up a new network connection.
- Reset
This setting is only visible if a WiFi network has already been set up. The WiFi function is deactivated and the WiFi connection will be reset to the factory default. You must set up a new WiFi connection to be able to use Miele@home.
The network settings should be reset whenever a steam oven is being disposed of or sold, or if a used steam oven is being put into operation. This is the only way to ensure that all personal data has been removed and the previous owner will no longer be able to access the steam oven.
- Set up
This setting is only visible if no WiFi connection has been set up yet. You must set up a new WiFi connection to be able to use Miele@home.

Settings

Remote control

If you have installed the Miele@mobile app on your mobile device, have access to the Miele@home system and have activated the remote control function (On), you can use the MobileStart function and for example retrieve information about steam oven cooking processes that are in progress or end a process that is in progress.

The steam oven requires max. 2 W when operating in networked standby.

Activating MobileStart

- Select the  sensor control to activate MobileStart.

The  sensor control lights up. You can operate your steam oven remotely with the Miele@mobile app.

Directly operating the steam oven takes priority over operating it via the remote control function on the app.

You can use MobileStart as long as the  sensor control is lit up.

RemoteUpdate

The RemoteUpdate menu option is only displayed and can only be selected if the requirements for using Miele@home have been met (see “Before using for the first time – Miele@home”).

The RemoteUpdate function is used for updating the software in your steam oven. If an update is available for your steam oven, it will automatically download it. Updates will not be installed automatically. They must be initiated manually.

If you do not install an update, you can continue to use your steam oven as usual. However, Miele recommends installing updates.

Activating/deactivating

The RemoteUpdate function is activated as standard. Available updates will be downloaded automatically but will only be installed if you initiate installation manually.

Deactivate RemoteUpdate if you do not want any updates to be downloaded automatically.

Running RemoteUpdate

Information about the content and scope of an update will be provided in the Miele@mobile app.

A message will appear in your steam oven display if a software update is available.

You can install the update immediately or postpone this until later. When the steam oven is switched on again, you will be reminded about the update.

Deactivate RemoteUpdate if you do not want to install the update.

The update may take several minutes.

Please note the following information about the RemoteUpdate function:

- You will only receive a message when an update is available.
- Once an update has been installed, it cannot be undone.
- Do not switch the steam oven off during the update. Otherwise, the update will be aborted and will not be installed.
- Some software updates can only be carried out by the Miele Customer Service Department.

Software version

The software version is intended for the Miele Customer Service Department. You do not need this information for domestic use.

Showroom programme

This function enables the steam oven to be demonstrated in showrooms without heating up. This setting is not needed for domestic use.

Demo mode

If you have demo mode activated, Demo mode is activated. The appliance will not heat up will appear when you switch the steam oven on.

- On
Touch the OK sensor control for at least 4 seconds to activate demo mode.
- Off
Touch the OK sensor control for at least 4 seconds to deactivate demo mode. You can then use the steam oven as normal.

Factory default

- Appliance settings
Any settings that have been altered will be reset to the factory default settings.
- User programmes
All User programmes will be deleted.
- Recommended temperatures
Any recommended temperatures that have been changed will be reset to the factory default settings.

Minute minder

Using the Minute minder function

The  minute minder can be used to time other activities in the kitchen, e.g. boiling eggs.

The minute minder can also be used at the same time as a cooking programme for which the cooking duration start and finish times have been set (e.g. as a reminder to stir the food or add seasoning, etc.).

- The maximum minute minder time that can be set is 59 minutes and 59 seconds.

Setting the minute minder

If you have selected the Display | Quick-Touch | Off setting, you will need to switch the steam oven on before setting the minute minder. The minute minder can then be seen counting down in the display when the steam oven is switched off.

Example: you want to boil some eggs and set a minute minder duration of 6 minutes and 20 seconds.

- Select the  sensor control.
- Select Minute minder if a cooking programme is in progress at the same time.

The prompt Set 00:00 min appears.

- Using the navigation area, set 06:20.
- Confirm with OK.

The minute minder duration is now saved.

When the steam oven is switched off the minute minder duration counts down in the display and  appears instead of the time of day.

If you are cooking at the same time,  and the minute minder duration will appear at the bottom of the display.

If you are in a menu, the minute minder counts down in the background.

At the end of the minute minder duration,  will flash, the time will start counting up and a tone will sound.

- Select the  sensor control.
- If required, confirm with OK.

The buzzer will stop and the symbols in the display will go out.

Changing the minute minder duration

- Select the  sensor control.
- Select Minute minder if a cooking programme is in progress at the same time.
- Select Change.
- Confirm with OK.

The minute minder duration selected appears.

- Change the duration set for the minute minder.
- Confirm with OK.













The altered minute minder duration is now saved.

Deleting the minute minder duration



- Select the 🕒 sensor control.
- Select Minute minder if a cooking programme is in progress at the same time.
- Select Delete.
- Confirm with *OK*.

The minute minder duration is now deleted.

Main and sub-menus

Menu	Recommended value	Range
Oven functions		
Steam cooking 	100 °C	40–100 °C
Fan plus 	160 °C	30–225 °C
Combi mode 		
Combi Fan plus 	170 °C	30–225 °C
Combi Conventional 	180 °C	30–225 °C
Combi Grill 	Level 3	Level 1–3
Sous-vide 	65 °C	45–90 °C
User programmes 		
Reheat 	130 °C	120–140 °C
Defrost 	60 °C	50–60 °C
Descalc 		
Automatic programmes 		
Further 		
Conventional heat	180 °C	30–225 °C
Intensive bake	180 °C	50–225 °C
Bottom heat	190 °C	100–200 °C
Top heat	190 °C	100–225 °C
Full grill	Level 3	Level 1–3
Economy grill	Level 3	Level 1–3
Fan grill	200 °C	50–225 °C
Cake plus	160 °C	30–225 °C
Eco Fan heat	160 °C	30–225 °C

Main and sub-menus

Menu	Recommended value	Range
Further 		
Eco Steam cooking	100 °C	40–100 °C
Special applications	–	–
Mix & Match		
Blanching	–	–
Bottling	90 °C	80–100 °C
Drying	60 °C	60–70 °C
Prove dough	–	–
Disinfect items	–	–
Heat crockery	50 °C	50–80 °C
Keeping warm	65 °C	40–100 °C
Maintenance		
Soak		
Drying		
Rinse		
Settings 		

Energy saving tips

Cooking programmes

- Remove all accessories from the oven compartment that are not required for cooking.
- In general, if a range of temperatures is given in a recipe or chart, it is best to select the lower temperature and to check the food after the shortest duration.
- Preheat the oven compartment only if instructed to do so in the recipe or the cooking chart.
- If possible, do not open the door during a programme.
- Dark, matt tins are best for baking. They absorb the heat more effectively and transmit it to the mixture more quickly. Shiny materials such as stainless steel or aluminium reflect the heat and therefore can give a more uneven result. Do not cover the oven floor or the rack with heat-reflecting aluminium foil.
- Monitor cooking durations to avoid wasting energy when cooking. Set the cooking duration, or use a food probe if you have one.
- The Fan plus  function can be used for cooking many types of food. Because the fan distributes the heat in the oven compartment straight away, it allows you to use a lower temperature than you would with Conventional heat. It also enables you to cook on multiple shelf levels at the same time.
- Fan grill is the best function for grilled dishes. With this function you can use lower temperatures than in other grill functions which use the maximum temperature setting.
- The Eco Fan heat function ensures energy-efficient cooking thanks to optimal utilisation of heat. Use this function for sweet and savoury bakes and gratins. Do not open the door during the cooking programme.
- You can use the Eco Steam cooking function to save energy during steam cooking. This function is particularly suitable for cooking fish and vegetables.
- Whenever possible you should cook multiple foods at the same time. Place them next to each other in the oven or on different shelf levels.
- Foods which you are unable to cook at the same time should, if possible, be cooked one after the other in order to make use of existing heat in the oven.

Customising settings

- Select Display | QuickTouch | Off for the control elements to reduce energy consumption.
- For the oven interior lighting, select Lighting | Off or “On” for 15 seconds. The oven interior lighting can be switched on again at any time by touching the  sensor control.

Energy-saving mode

The steam oven will switch itself off automatically to save energy if a programme is not being run and controls have not been operated. The time of day will appear in the display or the display will remain dark (see “Settings”).

Operation

Malfunction due to missing floor filter.

If the floor filter is missing, food deposits can get into the drain. The water cannot be pumped away.

Before each cooking programme, check that the filter in the floor of the oven compartment is correctly fitted.

- Switch the steam oven on.

The main menu will appear.

- If you want to cook using a steam function or bursts of steam, fill the water container and insert it into the appliance.

Distilled or carbonated water or other liquids could damage the steam oven.

Only use cold, fresh tap water (below 20 °C).

- Place the food in the oven compartment.
- Select the function you want.

The function will appear on the display. Depending on which function you have selected, the recommended values for temperature and moisture (if applicable) will appear one after the other.

- Change the recommended temperature if necessary.
- Confirm with *OK*.

The recommended temperature will be accepted within a few seconds. You can change the temperature subsequently via the arrow button.

- Change the moisture setting if necessary.
- Confirm with *OK*.

The required and the actual temperature will appear and the heating-up phase will begin.

You will see the temperature increasing. A buzzer will sound when the set temperature is reached for the first time.

- After cooking, select the sensor control for the selected function to end the cooking programme.

 Risk of injury caused by hot steam.

When using a cooking programme involving steam, a lot of hot steam can escape if the door is opened. The steam can cause burns. Step back and wait until the hot steam has dissipated.

- Take the food out of the oven.

 Risk of injury caused by hot surfaces.

The steam oven gets hot during operation. You can burn yourself on the door glass. Wear oven gloves when closing the hot door.

Cleaning the steam oven

- Remove the water container and condensate container and empty them as required.
- Switch the steam oven off.

Appliance rinsing appears after a cooking programme involving steam.

- Follow the instructions on the display.

The rinsing process should be carried out every time to flush any remaining food deposits out of the system.

If you have selected Display | Quick-Touch | Off in the settings menu, you will have to switch the steam oven on in order to open the door.

- Clean and dry the whole steam oven as described in “Cleaning and care”.
- Leave the appliance door open until the oven compartment is completely dry.

Refilling the water

If water needs replenishing during the programme, a tone will sound and the display will prompt you to refill the container with fresh water.

- Take out the water container and replenish the water.
- Push the water container into the appliance.

The cooking programme is resumed.

Changing values and settings for a cooking programme

Depending on the function, as soon as a cooking programme is in progress, you can use the ↵ sensor control to change the values or settings for this programme.

- Select the ↵ sensor control.

Depending on the function, the following settings appear:

- Temperature
- Moisture
- Duration
- Booster
- Pre-heat
- Crisp function



Changing values and settings

- Select the desired value or setting and confirm with *OK*.
- Change the value or setting and confirm with *OK*.

The cooking programme will restart with the new values and settings.

Operation

Changing the temperature

You can permanently reset the recommended temperature to suit your cooking preferences by selecting Further  | Settings  | Recommended temperatures.

- Select the  sensor control.
- Select Temperature and confirm with *OK*.
- Change the desired temperature via the navigation area.
- Confirm with *OK*.

The cooking programme will restart with the new desired temperature.

Changing Moisture

- Select the  sensor control.
- Select Moisture and confirm with *OK*.
- Change the moisture level.
- Confirm with *OK*.

The programme will continue to run at the new moisture level.

Setting cooking durations

Cooking results can be impaired if there is a long delay between the food being placed in the oven and the start of cooking. Fresh food can change colour and even deteriorate. When baking, the cake mixture or dough can dry out, and the raising agents can lose their effectiveness. Select as short as possible a time until the cooking programme starts.

You have placed the food in the oven compartment, selected a function and the required settings such as the temperature.

By entering Duration, Finish at or Start at via the  sensor control, you can automatically switch the cooking programme off or on and off.

- Duration
Enter the desired cooking duration for the food. The heating will switch off automatically once this duration has elapsed. The maximum cooking duration that can be set depends on the function that you have selected.
- Finish at
Specify when you want the cooking programme to end. The oven heating will switch off automatically at the time you have set.
- Start at
This function will only appear in the menu if you have set a Duration or Finish at time. With Start at, you have to specify when you want the cooking programme to start. The oven heating will switch on automatically at the time you have set.

- Select the ⊕ sensor control.
- Set the desired times.
- Confirm with *OK*.
- Touch the ↶ sensor control to return to the menu of the selected function.

When cooking with steam, the cooking duration does not begin until the set required temperature is reached.

The steam reduction function will switch on at the end of a cooking programme which used a temperature of over approx. 80 °C (steam cooking) or 80–100 °C and 100 % moisture (combination cooking).

- Wait until *Steam reduction* goes out in the display before opening the door and removing the food from the oven compartment.

Changing the set cooking durations

- Select the ⊕ sensor.
- Select the desired time.
- Confirm with *OK*.
- Select *Change*, if required.
- Change the set time.
- Confirm with *OK*.
- Touch the ↶ sensor to return to the menu of the selected function.

These settings will be deleted in the event of a power failure.

Tip: You can also adjust the cooking duration directly via the navigation area.

Operation

Deleting the set cooking durations

In functions and applications where it is always necessary to set a cooking duration, you can only delete the set times for Finish at and Start at.

- Select the ⌚ sensor control.
- Select the desired time.
- Confirm with *OK*.
- Select Delete.
- Confirm with *OK*.
- Touch the ⏪ sensor control to return to the menu of the selected function.

If you delete Duration, the set times for Finish at and Start at are also deleted.

If you delete Finish at or Start at, the cooking programme will start using the cooking duration set.

Tip: You can also delete the cooking duration directly via the navigation area.

Cancelling a cooking programme

You can cancel a cooking programme using the function sensor control that lights up orange or using the ⏪ sensor control.

The oven compartment heating and lighting will then switch off. Any cooking durations set will be deleted.

Touch the function sensor control to return to the main menu.

Cancelling a cooking programme without a set cooking duration

- Touch the sensor control for the selected function.

The main menu will appear.

- **Or:** select the ⏪ sensor control.
- Select Cancel process.
- Confirm with *OK*.

Cancelling a cooking programme with a set cooking duration

- Touch the sensor control for the selected function.

Cancel process? appears in the display.

- Select Yes.
- Confirm with *OK*.
- **Or:** select the ⏪ sensor control.
- Select Cancel process.
- Confirm with *OK*.
- Select Yes.
- Confirm with *OK*.

Interrupting a cooking programme

A cooking programme is interrupted as soon as the door is opened. The oven heating switches off.

The set cooking duration is saved when cooking with steam as well as for programmes and applications with pure steam operation.

 Risk of injury caused by hot steam.

When using a cooking programme involving steam, a lot of hot steam can escape if the door is opened. The steam can cause burns.

Step back and wait until the hot steam has dissipated.

 Risk of injury caused by hot surfaces and food.

The steam oven gets hot during operation. You could burn yourself on the heater elements, oven compartment, side runners, accessories, food or door glass.

Wear oven gloves when placing hot food in the oven or removing it, when adjusting oven shelves etc. in the hot oven compartment and when closing the hot door.

When placing cooking containers into the oven or removing them, make sure that the hot food does not spill out.

When cooking with steam as well as for programmes and applications with pure steam operation, the remaining time only continues to elapse once the set temperature has been reached.

In programmes using 100 % moisture and temperatures up to 100 °C: the cooking programme will finish early if the door is opened in the last minute of cooking (55 seconds remaining).

The cooking programme will resume when the door is closed.

The steam oven will heat up again and the display will show the temperature in the oven compartment as it rises.

Operation

Pre-heating the oven compartment

The **Booster** function is used to quickly pre-heat the oven compartment in some functions.



The **Pre-heat** function can be used with any oven function (except **Eco Fan heat**) and has to be switched on separately for each cooking programme.

If you have set a cooking duration, it will only start to count down after the heating-up phase.

It is only necessary to pre-heat the oven in a few instances.

- Pre-heat the oven compartment when cooking the following food:
 - Cakes and pastries with a short cooking duration (approx. 30 minutes or less) as well as delicate items (e.g. sponge) with the **Conventional heat** function

Booster

The **Booster** function is switched on as the factory default setting for the following functions (Further  | Settings  | **Booster | On**):

- Fan plus 
- Conventional heat

If you set a temperature above 100 °C and the **Booster** function is switched on, a rapid heating-up phase heats the oven compartment to the set temperature. The top heat/grill element and the ring heating element come on together with the hot air fan.

Delicate items (e.g. sponge or biscuits) will brown too quickly on the top if the **Booster** function is used. Switch off the **Booster** function for these items.

Switching the Booster on and off for a cooking programme

If you have selected the **Booster | On** setting, you can switch off the function separately for a cooking programme.

On the other hand, you can also switch on the function separately for a cooking programme if you have selected the **Booster | Off** setting.

Example: you have selected a function and the required settings such as the temperature.

You want to switch off the **Booster** function for this cooking programme.

- Select the  sensor control.
- Select **Booster | Off**.
- Confirm with **OK**.

The **Booster** function is switched off during the heating-up phase. Only the heating elements associated with the function are pre-heating the oven compartment.

Pre-heat

You can place most dishes in the cold oven compartment to make use of the heat produced during the heating-up phase.

If you have set a cooking duration, it will only start to count down when the desired temperature is reached and you have placed the food in the oven.

Start the cooking programme immediately without delaying the start time.

Switching on Pre-heat

The Pre-heat function has to be switched on separately for each cooking programme.

Example: You have selected a function and the required settings such as the temperature.

You want to switch on the Pre-heat function for this cooking programme.

- Select the  sensor control.
- Select Pre-heat | On.
- Confirm with *OK*.

The following message is displayed with a time: Place food in the oven at . The oven compartment is heated to the set temperature.

- As soon as you are prompted to do so, place the food in the oven compartment.
- Confirm with *OK*.

Crisp function

The Crisp function (moisture reduction) allows moisture to be removed from the oven as required during the entire cooking process or at times during the process.

It is a good idea to use this function when cooking items which have a moist topping, e.g. quiche, pizza, tray bakes with fresh fruit toppings or muffins.

Poultry in particular gets a good crisp skin with this function.

The Crisp function can be used in the following functions:

- Fan plus 
- Conventional heat
- Intensive bake
- Bottom heat
- Top heat
- Fan grill
- Cake plus

Operation

Switching on Crisp function

The Crisp function function has to be switched on separately for each cooking programme.

You have selected a function and the required settings such as the temperature.

You want to switch on the Crisp function function for this cooking programme.

- Select the ↩ sensor control.
- Select Crisp function | On.
- Confirm with *OK*.

The Crisp function function is switched on.

The Crisp function function can be switched off again at any time via the ↩ sensor control.

Releasing bursts of steam

You can release bursts of steam during the cooking process in all oven functions (except Eco Fan heat). The number of bursts of steam is unlimited.

You can release a burst of steam as soon as **Burst of steam** is highlighted on the display.

Please wait until the heating-up phase is completed to allow the steam to be distributed evenly in the warm air in the oven.

- Select *OK*.

The burst of steam will be released.  appears on the display and the **Burst of steam** goes out. This will take approximately 1 minute.

- Proceed as described to release further bursts of steam once **Burst of steam** appears on the display again.

This section contains general information. You will find more detailed information about particular foods and how to cook them in the other sections.

The advantages of cooking with steam

Almost all vitamins and minerals are retained as the food is not immersed in water.

Cooking with steam also retains the true taste of the food better than conventional cooking. We therefore recommend seasoning the food after it has been cooked. Food also retains its fresh, original colour.

Suitable containers

Cooking containers

Stainless steel cooking containers are provided with the steam oven. Other containers, in a variety of sizes, both perforated and solid, are available as optional extras (see “Optional accessories”). This enables you to choose the most suitable container for the meal you are preparing.

Use perforated cooking containers for **steam cooking** if possible. The steam can reach the food from all sides and the food is cooked evenly.

Your own containers

You can also use your own containers. However, please note the following:

- Containers must be suitable for use in an oven and able to withstand steam. With plastic containers, please check with the manufacturer that they are suitable for use in a steam oven.
- Thick-sided containers such as porcelain, ceramic or stoneware are not very suitable for using with steam. Due to their thick sides, they do not conduct heat well, meaning cooking durations will be considerably longer than those given in the charts.
- Place the containers on the rack or on a suitable tray. Depending on the size of the container, you can also place the rack on the floor of the oven compartment with the rack surface facing up and the cooking container on top. You can also take the side runners out to make more room (see “Cleaning the side runners” in the “Cleaning and care” chapter).
- Ensure that there is a gap between the upper rim of the container and the top of the oven compartment to allow sufficient steam into the container.

General notes

Shelf level

You can select any shelf level. You can also cook on several levels at the same time. This will not alter the cooking duration.

When using more than one deep container at the same time for steam cooking it is best to offset them on their runners and to leave at least one level free in between them.

Always insert cooking containers, the rack and the tray between the rails of the side runners so that they cannot tip.

Frozen food

The heating up phase for frozen food is longer than for fresh food. The greater the quantity of frozen food, the longer the heating up phase.

Temperature

During steam cooking, the temperature does not exceed 100 °C. Almost all foods can be cooked at this temperature. Some types of food, such as berries, need to be cooked at lower temperatures to prevent them from bursting. See the relevant sections in these operating instructions for more details.

Cooking duration

During steam cooking, the cooking duration does not begin until the set temperature is reached.

In general, the cooking durations for cooking with steam are the same as for cooking food in a saucepan. More information about any factors which may affect the cooking duration is given in the relevant sections.

The quantity of food does not affect the cooking duration. 1 kg of potatoes will take the same time to cook as 500 g.

Cooking with liquid

When cooking with liquid only fill the cooking container $\frac{2}{3}$ full to prevent the liquid spilling when the cooking container is removed from the oven.

Your own recipes - steam cooking

Food and recipes which are prepared in pot or a pan can also be cooked in the steam oven. The cooking times in the steam oven will be the same. Please note that food will not be brown or crisp when cooking with steam.

Universal tray and combi rack

Use the universal tray with the combi rack placed on top of it, e.g. for roasting and grilling. During roasting, you can use the meat juices collected in the tray to make a gravy or sauce.

If you are using the universal tray with the combi rack on top, insert the universal tray between the rails of a shelf level and the combi rack will automatically slide in above them. When removing them from the oven, pull both out together.

Non-tip safety notches

The combi rack and universal tray have non-tip safety notches which prevent them being pulled right out when they only need to be partially pulled out. The tray and rack can then only be taken out of the oven by raising them upwards and then pulling them out.

Steam cooking

Eco Steam cooking

You can use the Eco Steam cooking function to save energy during steam cooking. This function is suitable mainly for cooking fish and vegetables.

We recommend following the cooking durations and temperatures from the tables specified in “Steam cooking”. You can cook for longer if necessary.

When cooking starchy foods such as potatoes, rice and pasta, the best function to use is Steam cooking .

Settings

Further  | Eco Steam cooking

Notes on the cooking tables

Follow the instructions on cooking durations, temperatures and cooking notes.

Selecting the cooking duration

The cooking durations given are guidelines only.

- We recommend selecting the shorter duration initially. You can cook for longer if necessary.

Vegetables

Fresh

Prepare fresh vegetables in the usual way, i.e. wash, clean and cut them up.

Frozen food

Frozen vegetables do not need to be defrosted beforehand, unless they have been frozen together in a block.

Frozen and fresh vegetables which take the same length of time to cook can be cooked together.

If vegetables have frozen together in clumps, break these up before cooking with steam. Follow the manufacturer's instructions on the packaging regarding cooking duration.

Cooking containers

Food such as peas or asparagus spears, which have little or no space between them, will take longer to cook because the steam has less space to work in. For an even result, it is best to use a shallow container for these types of food, and only fill it about 3-5 cm deep. When cooking large quantities divide the food between 2 or 3 shallow containers rather than using one deep one.

Different types of vegetables which take the same length of time to cook can be cooked together.

Use solid containers for vegetables which are cooked in liquid.

Shelf level

To avoid any colour transfer when cooking vegetables with a distinctive colour (e.g. beetroot) in a perforated container, do not place other food underneath the perforated container.

Cooking duration

The cooking duration depends on the size of the food and how well cooked you want it, just as it does with conventional cooking methods. Example:

Waxy potatoes, cut into quarters:
approx. 17 minutes

Waxy potatoes, cut in half:
approx. 20 minutes

Settings

Automatic programmes  | Vegetables
| ... |

or

Steam cooking 

Temperature: 100 °C

Cooking duration: see table

Steam cooking

Vegetables	🕒 [min]
Artichokes	32–38
Cauliflower, whole	27–28
Cauliflower, florets	8
Beans, green	10–12
Broccoli, florets	3–4
Chantenay carrots, whole	7–8
Chantenay carrots, halved	6–7
Chantenay carrots, chopped	4
Chicory, halved	4–5
Chinese cabbage, chopped	3
Peas	3
Fennel, halved	10–12
Fennel, sliced	4–5
Kale, chopped	23–26
Waxy potatoes, peeled whole	27–29
halved	21–22
quartered	16–18
Mainly waxy potatoes, peeled whole	25–27
halved	19–21
quartered	17–18
Floury potatoes, peeled whole	26–28
halved	19–20
quartered	15–16
Kohlrabi, cut into batons	6–7
Pumpkin, diced	2–4
Corn on the cob	30–35
Chard, chopped	2–3

Steam cooking

Vegetables	 [min]
Peppers, diced or sliced	2
New potatoes, firm	30–32
Mushrooms	2
Leeks, sliced	4–5
Leeks, halved lengthways	6
Romanesco, whole	22–25
Romanesco, florets	5–7
Brussels sprouts	10–12
Beetroot, whole	53–57
Red cabbage, chopped	23–26
Black salsify, whole	9–10
Celeriac, cut into batons	6–7
Asparagus, green	7
Asparagus, white, whole	9–10
Carrots, chopped	6
Spinach	1–2
Spring cabbage, chopped	10–11
Celery, chopped	4–5
Swede, chopped	6–7
White cabbage, chopped	12
Savoy cabbage, chopped	10–11
Courgettes, sliced	2–3
Sugar snap peas	5–7

 Cooking duration

Steam cooking

Fish

Fresh

Prepare fresh fish in the usual way, i.e. clean, gut and fillet.

Frozen food

Fish does not need to be fully defrosted before cooking. Defrost so that the surface is sufficiently thawed to take herbs and seasoning. Depending on the thickness of the fish, 2 - 5 minutes should be enough.

Preparation

Add some lemon or lime juice to fish before cooking. The citric acid helps the flesh stay firm.

It is not necessary to season fish with salt when cooking with steam as this method retains the minerals which give the fish its unique flavour.

Cooking containers

If using a perforated container, grease it first.

Shelf level

When cooking fish in a perforated container at the same time as cooking other types of food in other containers, place the container with the fish directly above the universal tray to catch any liquid and so avoid any transfer of tastes to other food.

Temperature

85 °C – 90 °C

For gently cooking delicate types of fish, such as sole.

100 °C

For cooking firmer types of fish, e.g. cod and salmon.
Also for cooking fish in sauce or stock.

Duration

The cooking duration depends on the thickness and the texture of the fish, and not on the weight. The thicker the fish, the longer the cooking duration. A 3 cm thick piece of fish weighing 500 g will take longer to cook than a 2 cm thick piece of fish weighing 500 g.

The longer fish cooks, the firmer its flesh will become. Use the cooking durations given in the chart. If you find that the fish is not cooked sufficiently only cook it for a few minutes more.

When cooking fish in sauce or stock, we recommend that you increase the cooking duration quoted by a few minutes.

Tips

- Adding herbs and spices, such as dill, will help bring out the full flavour of the fish.
- Cook large fish in swimming position. To help maintain the shape of the fish, place a small cup or similar upside down in the cooking container, and arrange the fish belly-side down over the cup.
- You can use any fish scraps, e.g. fish heads, bones, tails etc to make a **fish stock**. Place the fish scraps together with some mixed vegetables in a solid cooking container and add cold water. Cook at 100 °C for 60 to 90 minutes. The longer the cooking duration, the stronger the stock.
- Preparing fish **au bleu** is a method involving cooking the fish in water with vinegar, at different proportions depending on the recipe. It is important not to damage the skin of the fish. This method is suitable for cooking carp, trout, tench, eel and salmon.

Settings

Automatic programmes Auto | Fish | ... |

or

Steam cooking 

Temperature: see table

Cooking duration: see table

Steam cooking

Fish	🌡️ [°C]	🕒 [min]
Eel	100	5–7
Perch fillet	100	8–10
Seabream fillet	85	3
Trout, 250 g	90	10–13
Halibut fillet	85	4–6
Cod fillet	100	6
Carp, 1.5 kg	100	18–25
Salmon fillet	100	6–8
Salmon steak	100	8–10
Salmon trout	90	14–17
Basa fillet	85	3
Rosefish fillet	100	6–8
Haddock fillet	100	4–6
Plaice fillet	85	4–5
Monkfish fillet	85	8–10
Sole fillet	85	3
Turbot fillet	85	5–8
Tuna fillet	85	5–10
Pike perch fillet	85	4

🌡️ Temperature 🕒 Duration

Meat

Fresh

Prepare the meat in the usual way.

Frozen food

Meat should be thoroughly defrosted before cooking in the steam oven (see “Special applications” – “Defrost”).

Preparation

For meat which needs to be seared before being cooked, e.g. for a stew, sear the meat in a pan on the hob first.

Duration

The cooking duration depends on the thickness and the texture of the meat, and not on the weight. The thicker the piece of meat, the longer the cooking duration. A piece of meat weighing 500 g which is 10 cm thick will take longer to cook than a piece of meat weighing 500 g which is 5 cm thick.

Tips

- To retain the **flavourings**, use a perforated cooking container. Place an unperforated cooking container underneath in order to collect the concentrate. You can use the concentrate to enhance your sauces or freeze it for later use.
- Boiling fowl, back or top rib and meat bones can be used to make **stock**. Place the meat together with the bones and some mixed vegetables in a cooking container and add cold water. The longer the cooking duration, the stronger the stock.

Settings

Automatic programmes  | Meat | ... |

or

Steam cooking 

Temperature: 100 °C

Cooking duration: see table

Steam cooking

Meat	🕒 [min]
Leg steak, covered with water	110–120
Pork knuckle	135–140
Chicken breast	8–10
Hock	105–115
Top rib, covered with water	110–120
Veal strips	3–4
Gammon slices	6–8
Lamb stew	12–16
Poularde	60–70
Turkey roulades	12–15
Turkey escalopes	4–6
Short rib, covered with water	130–140
Beef goulash	105–115
Whole chicken, covered with water	80–90
Topside	110–120

🕒 Cooking duration

Rice

Rice swells when cooked and needs to be cooked in liquid. The proportion of rice to liquid will vary depending on the type of rice.

The rice absorbs all the liquid during the cooking process and so none of the nutrients are lost.

Settings

Automatic programmes  | Rice | ... |

or

Steam cooking 

Temperature: 100 °C

Cooking duration: see table

	Ratio Rice : Liquid	 [min]
Basmati rice	1 : 1.5	15
Parboiled rice	1 : 1.5	23–25
Round grain rice		
Pudding rice	1 : 2.5	30
Risotto rice	1 : 2.5	18–19
Brown rice	1 : 1.5	26–29
Wild rice	1 : 1.5	26–29

 Duration

Steam cooking

Grain

Grain swells during cooking and needs to be cooked in liquid. The proportion of grain to liquid depends on the type of grain.

Grain can be cooked whole or cracked.

Settings

Automatic programmes  | Grain | ... |

or

Steam cooking 

Temperature: 100 °C

Cooking duration: see table

	Ratio Grain : Liquid	 [min]
Amaranth	1 : 1.5	15–17
Bulgur	1 : 1.5	9
Green spelt, whole	1 : 1	18–20
Green spelt, cracked	1 : 1	7
Oats, whole	1 : 1	18
Oats, cracked	1 : 1	7
Millet	1 : 1.5	10
Polenta	1 : 3	10
Quinoa	1 : 1.5	15
Rye, whole	1 : 1	35
Rye, cracked	1 : 1	10
Wheat, whole	1 : 1	30
Wheat, cracked	1 : 1	8

 Duration

Pasta

Dry pasta

Dry pasta swells when it is cooked and needs to be cooked in liquid. The liquid must cover the pasta. Using hot liquid gives better results.

Increase the cooking time stated by the manufacturer by approx. $\frac{1}{3}$.

Fresh food

Fresh pasta, such as the kind you can buy from the supermarket chilled counter, does not need to absorb water. Cook fresh pasta in a greased perforated container.

Separate any pieces of pasta which have stuck together and spread them out in the cooking container.

Settings

Automatic programmes  | Pasta | ... |

or

Steam cooking 

Temperature: 100 °C

Cooking duration: see table

Fresh	 [min]
Gnocchi	2
Knöpfli	1
Ravioli	2
Spätzle	1
Tortellini	2
Dry pasta, covered with water	
Tagliatelli	14
Vermicelli	8

 Duration

Steam cooking

Dumplings

Ready made boil-in-the-bag dumplings need to be well covered with water as otherwise they can fall apart. This is because even though they have been soaked in water beforehand they will not absorb enough moisture.

Cook fresh dumplings in a greased, perforated container.

Settings

Automatic programmes  | Pasta | ... |

or

Steam cooking 

Temperature: 100 °C

Cooking duration: see table

	 [min]
Sweet dumplings	30
Yeast dumplings	20
Boil-in-the-bag potato dumplings	20
Boil-in-the-bag bread dumplings	18–20

 Duration

Dried pulses

Soak pulses for at least 10 hours in cold water before cooking. Soaking makes the pulses more digestible and shortens the cooking duration required. Soaked pulses must be covered with liquid during cooking.

Lentils do not need to be soaked before cooking.

With unsoaked pulses a certain ratio of pulses to liquid is required depending on variety.

Settings

Automatic programmes  | Pulses | ... |

or

Steam cooking 

Temperature: 100 °C

Cooking duration: see table

Soaked	
	 [min]
Beans	
Kidney beans	55–65
Adzuki beans	20–25
Black beans	55–60
Pinto beans	55–65
Haricot beans	34–36
Peas	
Yellow split peas	40–50
Green split peas	27

 Duration

Steam cooking

Unsoaked		
	Ratio Pulses : Liquid	🕒 [min]
Beans		
Kidney beans	1 : 3	130–140
Adzuki beans	1 : 3	95–105
Black beans	1 : 3	100–120
Pinto beans	1 : 3	115–135
Haricot beans	1 : 3	80–90
Lentils		
Brown lentils	1 : 2	13–14
Red lentils	1 : 2	7
Peas		
Yellow split peas	1 : 3	110–130
Green split peas	1 : 3	60–70

🕒 Duration

Hen's eggs

Use a perforated container to boil eggs in the steam oven.

The eggs do not need to be pierced before cooking as they are gradually warmed during the heating up phase and so do not burst when they are cooked with steam.

When using a solid container for making egg dishes such as scrambled eggs, remember to grease it first.

Settings

Automatic programmes  | Hen's eggs | ... |

or

Steam cooking 

Temperature: 100 °C

Cooking duration: see table

	 [min]
Small soft medium hard	3 5 9
Medium soft medium hard	4 6 10
Large soft medium hard	5 6–7 12
Extra large soft medium hard	6 8 13

 Duration

Steam cooking

Fruit

Cook fruit in a solid container so that none of the juice is lost. If you wish to cook fruit in a perforated container, place a solid container directly underneath it to collect the juice.

Tip: You can use the juice which has collected in the solid container to make a glaze for a fruit flan.

Settings

Automatic programmes  | Fruit | ... |

or

Steam cooking 

Temperature: 100 °C

Cooking duration: see table

	 [min]
Apple chunks	1–3
Pear chunks	1–3
Cherries	2–4
Mirabelle plums	1–2
Nectarine/peach chunks	1–2
Plums	1–3
Quinces, diced	6–8
Rhubarb chunks	1–2
Gooseberries	2–3

 Cooking duration

Sausages

Settings

Automatic programmes  | Sausages
| ... |

or

Steam cooking 

Temperature: 90 °C

Cooking duration: see table

Sausages	 [min]
Frankfurters	6–8
Bologna sausages	6–8
Veal sausages	6–8

 Duration

Shellfish

Preparation

Defrost frozen shellfish before cooking with steam.

Peel, remove and discard the intestines, and then wash the shellfish.

Cooking containers

If using a perforated container, grease it first.

Duration

The longer shellfish are cooked, the tougher they become. Use the cooking durations given in the chart.

When cooking shellfish in sauce or stock, we recommend that you increase the cooking duration quoted by a few minutes.

Settings



Automatic programmes  | Shellfish | ... |

or

Steam cooking 

Temperature: see table

Cooking duration: see table

	 [°C]	 [min]
Crevettes	90	3
Prawns	90	3
King prawns	90	4
Small shrimps	90	3
Lobster	95	10–15
Large shrimps	90	3

 Temperature  Duration

Steam cooking

Mussels

Fresh food

 Danger of food poisoning from spoiled mussels.
Spoiled mussels can cause food poisoning.
Only cook mussels which are closed.
Do not eat mussels which have not opened after being cooked.

Steep fresh mussels in water for a few hours before cooking to rinse out any sand. Then scrub the mussels thoroughly to clean them.

Frozen food

Defrost frozen mussels before cooking.

Duration

The longer mussels are cooked, the tougher they become. Use the cooking durations given in the chart.

Settings



Automatic programmes  | Mussels and clams | ... |

or

Steam cooking 

Temperature: see table

Cooking duration: see table

	 [°C]	 [min]
Barnacles	100	2
Cockles	100	2
Mussels	90	12
Scallops	90	5
Razor clams	100	2–4
Venus clams	90	4

 Temperature  Duration

Menu cooking (cooking whole meals)

Before cooking meals with the manual menu cooking function, switch off steam reduction (see “Settings – Steam reduction”).

When cooking a menu, you can combine different foods with different cooking durations, e.g. fish fillet with rice and broccoli.

The food is placed in the steam oven compartment at different times so that each item is ready at the same time.

Shelf level

Place foods that produce a lot of liquid (e.g. fish) or have a distinctive colour (e.g. beetroot) directly above universal tray. This avoids any transfer of flavour or colour to other food and prevents liquid dripping onto food below it.

Temperature

Whole meals should be cooked at a temperature of 100 °C as this is the temperature required to cook the majority of foods.

Do not cook a whole meal at the lowest temperature when different temperatures are required for different types of food, e.g. 85 °C for seabream and 100 °C for potatoes.

If the recommended cooking temperature for the food is 85 °C for example, try cooking it at 100 °C and testing the result. Some delicate types of fish with a soft structure, e.g. sole and plaice will become very firm when cooked at 100 °C.

Duration

If you are increasing the recommended temperature, shorten the cooking duration by approx. $\frac{1}{3}$.

Example

Food cooking durations

(see cooking tables in “Steam cooking”)

Parboiled rice	24 minutes
Rosefish fillet	6 minutes
Broccoli	4 minutes

Calculation of set cooking durations:

24 minutes minus

6 minutes = 18 minutes (1st cooking duration: rice)

6 minutes minus 4 minutes = 2 minutes (2nd cooking duration: rosefish fillet)

Remaining time = 4 minutes (3rd cooking duration: broccoli)

Cooking duration	24 min. – rice		
		6 min. – fish fillet	
			4 min. – broccoli
Settings	18 min.	2 min.	4 min.

Steam cooking

Cooking a whole menu

- Place the rice in the oven compartment first.
- Set the 1st cooking duration: 18 minutes.
- After the 18 minutes, place the fish into the appliance.
- Set the 2nd cooking duration: 2 minutes.
- After the 2 minutes, place the broccoli into the appliance.
- Set the 3rd cooking duration: 4 minutes.

Sous-vide (vacuum) cooking

With this gentle cooking method, food is cooked slowly and at a low, constant temperature in vacuum packaging.

With vacuum cooking, no moisture evaporates during cooking and all nutrients and flavours are retained.

The cooking result has an intensive taste and food is cooked evenly.

Use only fresh food which is in a good condition.

Ensure hygienic conditions and that food has not been out of the refrigerator too long, e.g. during transportation.

Use only heat-stable, boiling-resistant vacuum sealing bags.

Do not cook food in the sales packaging, such as vacuum-packed frozen food as it is possible that the packaging used is not suitable for vacuum cooking.

Do not use the vacuum sealing bag more than once.

Vacuum-seal the food in a chamber system vacuum sealer only.

Sous-vide (vacuum) cooking

Important usage notes

For best cooking results, follow the instructions below:

- Use herbs and spices more sparingly than with conventional cooking methods because the impact on the taste of the food will be stronger. You can also cook the food unseasoned and add seasoning after cooking.
 - The cooking duration is reduced when salt, sugar and liquids are added.
 - The food becomes firmer if acidic ingredients such as lemon or vinegar are added.
 - Do not use alcohol or garlic as this can produce unpleasant flavours.
 - Only use vacuum sealing bags that match the size of the food. If the vacuum sealing bag is too big, too much air can remain inside.
 - If you want to cook several items of food in one vacuum sealing bag, put them side-by-side in the bag.
 - If you want to cook food in several vacuum sealing bags at once, put the bags side-by-side on the rack.
 - The cooking durations depend on the thickness of the food.
 - With high temperatures and/or long cooking durations, the appliance may run low on water. Check the display from time to time.
- Keep the door closed during the cooking programme. Opening the door will prolong the cooking process and can change the cooking result.
 - Temperatures and cooking durations from sous-vide recipes cannot always be emulated exactly. Alter the settings to achieve the degree of cooking you want.

Sous-vide (vacuum) cooking

Tips

- In order to reduce cooking times, you can vacuum-seal food items 1–2 days before the cooking programme. Store the vacuum-sealed food in the refrigerator at no more than 5 °C. In order to preserve quality and flavour, the food should be cooked no later than 2 days afterwards.
- Freeze liquids such as marinades before vacuum-sealing to prevent them from escaping from the bag.
- Fold the edges of the vacuum sealing bag outwards for filling. This will give you clean, perfect seams.
- If you do not want to eat the food straight after cooking, put it in iced water immediately and allow it to cool down completely. After this, store the food at temperatures no greater than 5 °C.
This way, you can retain the food's quality and flavour while keeping it fresh for longer.
Exception: Poultry must be eaten straight after the cooking programme.
- After cooking, cut the vacuum sealing bag on all sides for easier access to the food.
- Briefly fry meat and firm types of fish (such as salmon) before serving for a roasted aroma.
- Use the stock or marinade of vegetables, fish or meat to make a sauce.
- Serve the food on pre-warmed plates.

Sous-vide (vacuum) cooking

Using the Sous-vide function

- Rinse the food with cold water and dry it.
- Place the food in a vacuum sealing bag and add spices or liquid if desired.
- Vacuum-seal the food in a chamber system vacuum sealer.
- For the best cooking results, place the rack on shelf level 2.
- Place the vacuum-sealed food on the rack (next to each other if there are several bags).
- Select Sous-vide .
- Change the recommended temperature if necessary.
- Confirm with *OK*.
- Set further settings as necessary (see “Operation”).

Possible reasons for unsatisfactory results

The bag has opened:

- The seal was not clean or strong enough and has opened.
- The bag was damaged by a sharp bone.

The food has an unpleasant or strange taste:

- Incorrect storage of the food; the food was kept out of the refrigerator for too long.
- The food was contaminated with bacteria before it was vacuum sealed.
- Too much of ingredients such as spices was added.
- The bag or seal was not in perfect order.
- The vacuum was insufficient.
- The food was not eaten or chilled immediately after cooking.

Sous-vide (vacuum) cooking

The cooking durations given in the tables are guidelines only. We recommend selecting the shorter duration initially. You can cook for longer if necessary. The cooking duration only begins when the set temperature is reached.

Food	Added in advance		🌡️ [°C]	⌚ [min]
	Sugar	Salt		
Fish				
Atlantic cod fillet, 2.5 cm thick		x	54	35
Salmon fillet, 2–3 cm thick		x	52	30
Monkfish fillet		x	62	18
Pikeperch fillet, 2 cm thick		x	55	30
Vegetables				
Cauliflower florets, medium to large		x	85	40
Hokkaido pumpkin, sliced		x	85	15
Kohlrabi, sliced		x	85	30
Asparagus, white, whole	x	x	85	22–27
Sweet potato, sliced		x	85	18
Fruit				
Pineapple, sliced	x		85	75
Apples, sliced	x		80	20
Baby bananas, whole			62	10
Peaches, halved	x		62	25–30
Rhubarb chunks			75	13
Plums, halved	x		70	10–12
Other				
Beans, white, soaked in a ratio of 1:2 (beans to liquid)		x	90	240
Prawns, peeled and deveined		x	56	19–21
Hen's egg, whole			65–66	60
Scallops, removed from shell			52	25
Shallots, whole	x	x	85	45–60

🌡️ Temperature ⌚ Duration

Sous-vide (vacuum) cooking

Food	Added in advance		🌡️ [°C]		🕒 [min]
	Sugar	Salt	Medium*	Done*	
Meat					
Duck breast, whole		x	66	72	35
Saddle of lamb			58	62	50
Beef fillet steak, 4 cm thick			56	61	120
Beef rump steak, 2.5 cm thick			56	–	120
Pork tenderloin, whole		x	63	67	60

🌡️ Temperature 🕒 Duration

* Degree of cooking

The “well done” cooking degree uses a higher core temperature than “medium”, but results are not the same as being well-done in the traditional sense.

Reheating

Only reheat brassicas, such as kohlrabi and cauliflower, in combination with a sauce. Without sauce, an unpleasant cabbage-like taste and grey-brown colour may develop.

Food with a short cooking duration or which continues cooking during reheating, such as fish, is not suitable for reheating.

Preparation

Place the cooked food into ice water for approx. 1 hour directly after cooking. The rapid cooling prevents the food from continuing to cook, which helps retain the optimum cooked condition. Then store the food in the refrigerator at a maximum temperature of 5 °C.

Please note that the quality of the food decreases the longer it is stored.

We recommend that you do not store the food in the refrigerator for longer than 5 days before reheating.

Settings

Sous-vide 

Temperature: see table

Duration: see table

Sous-vide (vacuum) cooking

Reheating with the Sous-vide function

The durations specified in the table are guidelines only. You can increase the duration if necessary. The cooking duration only begins when the set temperature is reached.

Food	🌡️ [°C]		🕒 ² [min]
	Medium ¹	Done ¹	
Meat			
Saddle of lamb	58	62	30
Beef fillet steak, 4 cm thick	56	61	30
Beef rump steak, 2.5 cm thick	56	–	30
Pork tenderloin, whole	63	67	30
Vegetables			
Cauliflower florets, medium to large ³	85		15
Kohlrabi, sliced ³	85		10
Fruit			
Pineapple, sliced	85		10
Other			
Beans, white, soaked in a ratio of 1:2 (beans to liquid)	90		10
Shallots, whole	85		10

🌡️ Temperature, 🕒 Time

1 Degree of cooking

The “well done” cooking degree uses a higher core temperature than “medium”, but results are not the same as being well-done in the traditional sense.

2 Durations apply to vacuum-sealed food with an initial temperature of approx. 5 °C (refrigerator temperature).

3 Reheat only in sauce.

Reheat

To reheat food which was cooked using the sous-vide method, use the Sous-vide  function (see “Sous-vide – Reheating”).

The steam oven is very effective at reheating food gently, without drying it out or cooking it further. The food will reheat evenly and does not need to be stirred during the reheating process.

You can reheat individual dishes or plated meals which have been prepared previously (e.g. meat, vegetables and potatoes).

Suitable containers

Small quantities can be reheated on a plate, larger quantities should be placed in a cooking container.

Time

10–12 minutes are usually sufficient for one plate of food. More than one plate will need a little longer.

If you are reheating several plated meals one after the other, the reheating time can be reduced by around 5 minutes for the second and subsequent plates as the oven compartment will still be hot.

Moisture

The more moist the food, the less moisture needs to be added.

Tips

- Do not reheat large items, such as a joint of roast meat, whole. Divide it into portions and reheat these as plated meals.
- Compact items, such as stuffed peppers or roulades, should be cut in half.
- Reheat sauces separately. Exceptions are dishes such as goulash, which is cooked in sauce.
- Please note that breaded items, such as schnitzel, will not retain their crispness when they are reheated.

Food does not need to be covered before it is reheated.

Settings

Reheat 

or

Combi mode  | Combi Fan plus

Temperature: see chart

Moisture: see chart

Duration: see chart

Further applications

The durations specified in the chart are guidelines only. We recommend selecting the shorter duration initially. You can make the duration longer if necessary.

Food	🔥 [°C]	💧 [%]	⌚* [min]
Vegetables			
Carrots Cauliflower Kohlrabi Beans	120	70	8–10
Side dishes			
Pasta Rice Potatoes, cut in half lengthways	120	70	8–10
Dumplings Mashed potato	140	70	18–20
Meat and poultry			
Sliced meat, 1.5 cm thick Roulades, sliced Goulash Lamb stew Meatballs Chicken escalopes Turkey escalopes, sliced	140	70	11–13
Fish			
Fish fillet Fish roulade, halved	140	70	10–12
Plated meals			
Spaghetti, in tomato sauce Pork roast, potatoes and vegetables Stuffed peppers (cut in half), rice Chicken fricassee, rice Vegetable soup Creamed soup Clear broth Stew	120	70	10–12

🔥 Temperature, 💧 Moisture, ⌚ Duration

* These times apply to food heated on a plate.

Defrost

It is much quicker to defrost food in the steam oven than at room temperature.

 Risk of infection from bacteria. Bacteria such as salmonella can cause life-threatening food poisoning.

It is particularly important to observe food hygiene rules when defrosting fish and meat, and in particular when defrosting poultry.

Do not use the liquid produced during defrosting.

Process the food as required as soon as it has been defrosted.

Temperature

60 °C is the best temperature for defrosting.

Exception: 50 °C for minced meat and game

Before and after defrosting

Remove any packaging before defrosting.

Exceptions: Leave bread, biscuits and cakes in their packaging as otherwise they will absorb moisture and become soft.

Allow food to stand at room temperature for a few minutes after defrosting. The standing time is necessary to allow the even distribution of heat from the outside to the inside.

Cooking containers

Use a perforated container with the universal tray underneath when defrosting food which will drip, such as poultry. This way food will not be lying in defrosted liquid.

Food which does not drip can be defrosted in a solid container.

Tips

- Fish, for instance, does not need to be fully defrosted before cooking. Defrost so that the surface is sufficiently thawed to take herbs and seasoning. Depending on the thickness of the fish, 2–5 minutes is generally enough.
- When defrosting food which has frozen together, e.g. berries and meat portions, separate them half-way through the defrosting time.
- Do not refreeze food once it has thawed.
- Defrost frozen pre-cooked meals according to the instructions on the packaging.

Settings

Defrost 

or

Steam cooking 

Temperature: see chart

Defrosting duration: see chart

Standing time: see chart

Further applications

The durations specified in the table are guidelines only. We recommend selecting the shorter defrosting time initially. You can increase the defrosting time longer if necessary.

Frozen food	Quantity	🌡️ [°C]	🕒 [min]	⌚ [min]
Dairy products				
Sliced cheese	125 g	60	15	10
Quark	250 g	60	20–25	10–15
Cream	250 g	60	20–25	10–15
Soft cheese	100 g	60	15	10–15
Fruit				
Apple sauce	250 g	60	20–25	10–15
Apple chunks	250 g	60	20–25	10–15
Apricots	500 g	60	25–28	15–20
Strawberries	300 g	60	8–10	10–12
Raspberries/currants	300 g	60	8	10–12
Cherries	150 g	60	15	10–15
Peaches	500 g	60	25–28	15–20
Plums	250 g	60	20–25	10–15
Gooseberries	250 g	60	20–22	10–15
Vegetables				
Frozen in a block	300 g	60	20–25	10–15
Fish				
Fish fillets	400 g	60	15	10–15
Trout	500 g	60	15–18	10–15
Lobster	300 g	60	25–30	10–15
Small shrimps	300 g	60	4–6	5
Ready meals				
Meat, vegetables, side dishes/ stew/soup	480 g	60	20–25	10–15
Meat				
Roast meat, sliced	125–150 g each	60	8–10	15–20

Further applications

Frozen food	Quantity	🌡️ [°C]	🕒 [min]	⌚ [min]
Minced meat	250 g	50	15–20	10–15
	500 g	50	20–30	10–15
Goulash	500 g	60	30–40	10–15
	1000 g	60	50–60	10–15
Liver	250 g	60	20–25	10–15
Saddle of hare	500 g	50	30–40	10–15
Saddle of venison	1000 g	50	40–50	10–15
Cutlets/chops/sausages	800 g	60	25–35	15–20
Poultry				
Chicken	1000 g	60	40	15–20
Chicken thighs	150 g	60	20–25	10–15
Chicken escalopes	500 g	60	25–30	10–15
Turkey legs	500 g	60	40–45	10–15
Baked goods				
Puff pastries/yeast-dough pastry	–	60	10–12	10–15
Creamed mixture cakes/biscuits	400 g	60	15	10–15
Bread/rolls				
Bread rolls	–	60	30	2
Rye bread, sliced	250 g	60	40	15
Wholegrain bread, sliced	250 g	60	65	15
White bread, sliced	150 g	60	30	20

🌡️ Temperature 🕒 Defrosting time ⌚ Standing time

Further applications

Mix & Match

The Mix & Match special application is available to help with simple and uncomplicated preparation of plated meals. With this application, you can re-heat food that has already been cooked (convenience food) or assemble a portioned-out meal using fresh food and cook it on a plate.

During cooking, you have the choice between a crispy, browned result or gently cooked food with a succulent surface without additional browning.

Only use food that is completely hygienic. If you have any concerns, dispose of the food.

Containers

Use:

- a flat plate or a small ovenproof dish
- a deep bowl or a cup for food that requires liquid to be added

Baked goods, pizza, flammkuchen, etc. can be placed directly on the rack (with baking parchment if necessary).

The plastic containers for ready meals are not sufficiently heat-resistant.

Transfer ready meals into suitable cooking containers.

Tips for reheating plated meals

- For fried or gratin dishes, use **Crispy reheating** and for baked or boiled dishes, use **Gentle reheating**.
- Using **Crispy reheating** ensures that only food that was crispy before reheating stays crispy.
- The food should not exceed a height of 2–2.5 cm. Transfer taller food into flat containers (e.g. stew) or slice it into smaller pieces (e.g. roulades, bakes).
- Only reheat pasta mixed into a sauce.
- Droplets of water may have accumulated underneath the crockery. Dry the droplets of water before serving.

Tips for cooking plated meals

- You can easily make a sauce from the meat and fish stock: add 1 tsp of cornflour to the raw meat or fish before cooking. Stir the sauce with a fork until smooth before serving. You can also use 1 tsp of mashed potato powder (instant) or a pinch of guar gum instead of cornflour.
- If cooking durations for different foods are not the same, you can compensate for this by changing the size of the food: if the cooking duration is shorter, make the pieces larger (e.g. large cauliflower florets). If the cooking duration is longer, make the pieces smaller (e.g. diced potatoes).
- You can also compensate for differing cooking durations with layering: place food with a short cooking duration under a food with a long cooking duration or put them together as a small bake.
- To prevent the food from drying out, prepare your dish with a sauce or marinade. You can also use cheese or bacon.

Further applications

Assembling a plated meal using various components

For a good cooking result, you must put together the individual components of the dish – such as meat, side dishes and vegetables – so that a common setting can be selected for browning. This setting must be suitable for all elements of the meal, or at least conditionally suitable.

We recommend using the following procedure:

- Select a main ingredient based on the cooking charts, e.g. steak.
- Select other ingredients which have the corresponding settings for browning, e.g. green beans and rice.

Notes on the cooking charts

As well as information on portion sizes or the way the food needs to be processed prior to cooking, the cooking charts also provide tips on preparation.

The degree of browning is represented in the display by a bar with seven segments. Basically, the more segments that are filled, the longer the cooking duration.

You can use the icons to determine which setting is appropriate to brown the food:

Symbol	Meaning
—	Unsuitable
□	Conditionally suitable
■	Suitable

Using the Mix & Match special application

Food does not need to be covered while it is being cooked.

- Prepare the food as required.
- Select Further  | Special applications | Mix & Match.
- If you are preparing food that is already **cooked**, select Gentle reheating **or** Crispy reheating.
- If you are preparing food that is **fresh** or just partially cooked, select Gentle cooking **or** Crispy cooking.
- Change the setting for browning if necessary.
- Confirm with *OK*.
- Place the food onto the rack on shelf level 2.
- Confirm with *OK*.

You can start the cooking programme immediately or delay the start.

- If by the end of a cooking programme, the plated meal is not cooked enough for your taste, select *Cont. browning*.

Further applications

Reheat food with the “Crispy reheating” special application

Food	Browning segment bar setting
Apple strudel, 4 cm thick	___ _ _ _ □ ■ □ _ _
Baked camembert, 25 g	___ _ _ _ ■ □ _ _ _
Baked camembert, 75 g	___ _ _ _ □ ■ □ _ _
Baguettes, pre-baked	___ □ ■ □ _ _ _ _
Puff pastry canapés	_ □ ■ □ □ _ _ _
Puff pastry pockets, filled with spinach	_ □ ■ □ _ _ _ _
Börek pastry, 3 cm thick	___ _ _ □ □ ■ □
Fried potatoes (convenience)	___ _ □ ■ □ _ _ _
Patty ¹ , tofu	_ □ □ ■ □ _ _ _
Bread roll (wheat), pre-baked	___ _ □ ■ □ _ _ _
Bread roll (rye), pre-baked	___ _ _ □ ■ _ _ _
Bread roll, stale, soft	___ _ _ □ ■ _ _ _
Cheeseburger	___ _ □ ■ _ _ _ _
Chilli con carne ¹ , 2 cm deep	___ _ _ □ ■ □ _ _
Ciabatta rolls, pre-baked	___ _ _ ■ □ _ _ _
Ciabatta rolls, stale, soft	___ _ _ ■ □ _ _ _
Crêpe ¹	___ _ □ □ _ _ _ _
Flammkuchen (convenience)	_ □ ■ □ _ _ _ _
Flammkuchen, ready-made dough with own toppings	_ □ □ ■ _ _ _ _
Meat strips ¹ (convenience)	□ □ ■ □ □ _ _ _
Focaccia, pre-baked, 3–4 cm thick	□ □ □ ■ □ _ _ _
Meat patty ¹ (pork), 25 g	□ □ ■ □ □ □ □ _
Meat patty ¹ (pork), 60 g	___ _ _ □ ■ □ _ _
Meat patty ¹ (pork), 100 g	___ _ _ □ □ ■ □
Spring rolls, small	___ _ _ □ ■ □ _ _
Spring rolls	___ _ _ _ □ ■ □
Hot dog ¹	□ □ ■ □ _ _ _ _

Further applications

Food	Browning segment bar setting
Kaiserschmarrn pancake ¹ (convenience)	__ □ □ ■ □ □ __
Potatoes, fairly firm, sliced	__ _ □ ■ □ __ _
Potato pockets (convenience)	__ _ □ □ ■ □ __
Lasagne ¹ , 3 cm thick	__ _ _ ■ ■ □ □
Naan ¹ , pre-baked	__ □ ■ □ __ _ _
Pasta, fresh with sauce, cheese	__ _ □ □ □ __ _
Pasta bake ¹ , 2 cm deep	__ _ _ ■ □ __ _
Pasta bake ¹ , 4.5 cm deep	__ _ _ □ ■ __ _
Pasta bake ¹ , 6 cm deep	__ _ _ _ □ ■
Pancakes ¹	■ □ _ _ _ _ _
Pancakes ¹ , rolled	__ _ □ ■ □ __ _
Pita ¹ , pre-baked	□ □ ■ □ _ _ _
Pizza (convenience)	□ □ ■ □ □ □ _
Poffertjes pancake	__ _ _ □ ■ □ __
Quiche, small	□ □ ■ □ _ _ _
Quiche, 2 cm deep	__ _ _ □ ■ □ __
Quiche, 3.5 cm deep	__ _ _ _ □ ■ □
Potato pancakes	__ _ _ ■ □ __ _
Hash browns (convenience)	__ _ _ □ ■ □ __
Escalope	__ _ □ ■ □ □ __
Taco shell	□ □ ■ □ □ □ _
Hawaii toast	__ □ ■ □ _ _ _
Cheese on toast	□ ■ _ _ _ _ _
Tortilla chips with cheese	__ □ ■ □ __ _
Tortilla ¹ (rolled in aluminium foil)	□ □ ■ □ □ _ _

¹ is not crispy, only needs to be sufficiently heated (> 65 °C).

Further applications

Cooking food with the “Crispy cooking” special application

Food	Cooking tips	Browning segment bar setting
Meat¹		
Bratwurst (pork), boiled, 25 g	Cut	___ _ _ _ □ □ ■ □
Bratwurst (pork), boiled, 100 g	Cut	___ _ _ _ □ □ □
Bratwurst (pork), coarse	Brush with oil, cut	___ _ _ _ □ ■
Beef kebabs, large chunks	Marinated	□ ■ ___ _ _ _
Pork kebabs, large chunks	Marinated	□ □ □ ■ □ ___
Meat patty (pork), 60 g	–	___ _ _ _ □ ■ □
Chicken breast, 3 cm thick	With bacon, marinated	□ □ □ ■ □ ___
Chicken breast, 3 cm thick	On its own, marinated	___ □ □ ■ ___ _
Stuffed chicken breast	Filling: spinach, crème fraîche	___ □ □ ■ ___ _
Chicken kebabs, large chunks	Marinated	□ □ ■ □ ___ _
Chicken drumstick	Marinated	___ _ □ □ □ ■
Saddle of veal, 180 g	Marinated, with sauce	□ ___ _ _ _ _
Gammon, 2.5–4 cm thick	–	___ □ ■ □ □ □
Gammon cutlet, 2 cm thick	–	___ □ □ ■ □ ___
Lamb chop, 2 cm thick	Marinated	□ ■ □ □ ___ _
Steak, 2.5–3.5 cm thick	Marinated	___ □ ■ □ ___ _
Pork tenderloin, 4 cm thick	With bacon	□ □ ■ □ ___ _
Pork chop	Breaded, drizzled with oil	___ _ _ _ □
Fish¹		
Halibut cutlet	Marinated	□ ■ ___ _ _ _
Cod	With butter and breadcrumb crust	___ _ □ ■ □ ___
Cod fillet, 3–3.5 cm thick	Marinated	■ □ □ ___ _ _
Cod fillet roulade	Stuffed	■ □ ___ _ _ _
Salmon fillet, 2.5–3 cm thick	Marinated	□ □ ■ □ □ ___
Salmon cutlet	Marinated	□ □ ■ □ □ ___
Salmon kebab, large chunks	Marinated	□ □ ■ □ □ ___
Pollock fillet	Topping: spinach, feta	■ □ ___ _ _ _

Further applications

Food	Cooking tips	Browning segment bar setting
Tuna	With tomatoes, topped with cheese	___ _ □ ___ _
Catfish kebab, large chunks	Marinated	___ □ □ □ ■ ___
Side dishes		
Fried potatoes (convenience), gently fried	–	___ _ □ □ □ ■
Dates in bacon (convenience)	–	___ □ □ ■ □ ___
Fresh pasta, tortellini	–	□ ___ _
Gnocchi (convenience)	With small chunks of butter or cheese	■ □ ___ _
Potatoes ² , slices/small cubes	Brush with oil	___ _ □ □ □ ■
Potato pockets (convenience), pre-cooked	–	■ □ ___ _
Lasagne, pre-cooked, 3 cm thick	–	□ □ ___ _
Brown rice, cooking duration 8 minutes	Salt, 1 : 2 (rice : liquid)	___ □ ■ ___ _
Pasta bake, fresh pasta	Raw meat, vegetables, sauce	___ □ □ ■ □ □ □
Pasta bake, pre-cooked, 2 cm deep	–	□ ___ _
Potato pancakes (convenience mixture)	Brush with oil	___ _ □ □ ___
Rice (convenience), pre-cooked	–	□ □ ■ □ ___
Hash browns (convenience), pre-cooked	–	■ □ ___ _
Potato dumplings (convenience)	With small chunks of butter	□ □ □ □ □ □ ___
Vegetables		
Aubergine, 2 cm thick	Oil, salt, pepper	___ _ □ □ ___
Cauliflower, large florets	Salt and pepper	□ ___ _
Broccoli, large florets	Sauce	□ ■ □ ___ _
Beans, green (string beans)	With bacon, salt, pepper	___ _ ■ □ ___
Cherry tomatoes, whole	Marinated	■ □ □ □ ___
Kohlrabi, thick slices	Marinated	□ □ □ □ ___
Squash, in small cubes	Salt and pepper	■ □ ___ _
Corn on the cob	Marinated	___ □ □ ■ □ ___

Further applications

Food	Cooking tips	Browning segment bar setting
Carrots, quartered/in thick slices	Salt and pepper	□□□□_ _ _ _
Pepper, large chunks	Marinated	□□□□■□_ _ _ _
Ratatouille, roughly chopped	Tomato purée, ketchup, seasoning, cornflour	□□_ _ _ _ _ _
Courgette, 2 cm thick	Oil, salt, pepper	_ _ _ _ □□_ _ _ _
Other		
Baked camembert, 25 g	–	■□_ _ _ _ _ _
Baguette, part-baked bread rolls	–	□■□_ _ _ _ _
Bread roll, stale, soft	–	□□_ _ _ _ _ _
Cheeseburger, pre-cooked	–	□□_ _ _ _ _ _
Flammkuchen (convenience)	–	_ _ _ _ □■_ _ _ _
Flammkuchen, ready-made dough with own toppings	–	_ _ _ □■□_ _ _
Spring roll, frozen, 25 g	–	_ □■□_ _ _ _
Spring roll, frozen, 100 g	–	_ □□□_ _ _ _
Grilled cheese (convenience)	–	_ _ _ _ □■_ _
Kaiserschmarrn pancake (convenience)	–	_ _ _ □■□_ _
Kaiserschmarrn pancake, uncooked	–	_ _ _ _ □_ _ _
Tofu patty, pre-cooked	–	■□_ _ _ _ _ _
Onion tart (convenience)	–	_ _ _ _ □□_ _

¹ Add 1 tsp cornflour to raw meat/fish.

² Fairly firm

Food suitable for the “Gentle cooking” special application

Food	Cooking tip
Meat¹	
Sausage (pork)	–
Beef kebabs, large chunks	Marinated with peanut sauce
Pork kebabs	Marinated
Chicken breast, 150 g, 3 cm thick	On its own
Stuffed chicken breast	Filling: spinach, crème fraîche
Chicken kebabs, large chunks	Marinated
Chicken fricassee	–
Saddle of veal, 180 g	In sauce
Gammon, 230 g, 2.5–4 cm thick	Salt and pepper
Gammon cutlet (pork), 200 g, 2 cm thick	Salt and pepper
Meatballs (pork), 50–100 g each	In sauce
Fish¹	
Trout, whole, without head	Seasoned, butter
Cod fillet, 3–3.5 cm thick	Marinated
Cod fillet roulade	Stuffed, marinated
Salmon fillet, 2.5–3 cm thick	Marinated
Salmon cutlet	Marinated
Salmon kebab, large chunks	Marinated
Pollock fillet, 180 g	Topping: spinach and crème fraîche
Pollock fricassee, large chunks	With white sauce
Catfish kebab, large chunks	Marinated
Side dishes	
Basmati rice	Salt, ratio 1 : 2.5 (rice : liquid)
Fresh pasta, tortellini	Sauce, salt
Gnocchi (convenience)	Salt, covered with water
Potatoes, floury, halved	Salt
Potatoes ² , sliced or small cubes	Salt
Potatoes ² , quartered or in wedges	Salt

Further applications

Food	Cooking tip
Boil-in-the-bag potato dumplings (convenience)	Covered with water
Mashed potato, cooked	–
Mashed potato (convenience), dry product	According to the packet instructions
Macaroni, short, uncooked	Sauce, ratio 1 : 3 (pasta : water)
Brown rice, cooking duration 8 minutes	Salt, ratio 1 : 2 (rice : liquid)
Parboiled rice (convenience), cooking duration 8 minutes	Salt, ratio 1 : 2 (rice : liquid)
Parboiled rice, cooking duration 10–12 minutes	Salt, ratio 1 : 2 (rice : liquid)
Rice (convenience), pre-cooked	Salt
Potato dumplings (convenience)	Salt, small chunks of butter
Vermicelli, uncooked	Covered with stock
Vegetables	
Cauliflower, large florets	Salt
Beans, green (string beans)	With bacon or salt, pepper
Broccoli, large florets	With/without cheese sauce
Cherry tomatoes, whole	Marinated
Kohlrabi, sliced	Salt and pepper
Squash, in small cubes	Salt and pepper
Corn on the cob	Herb butter
Carrots, quartered or in thick slices	Seasoned
Pepper, large chunks	Marinated
Ratatouille, roughly chopped	Tomato purée, ketchup, seasoning, cornflour
Brussel sprouts, whole	Salt and pepper
Asparagus, spears, whole, 1–2 cm thick	Salt, pepper, small chunks of butter
Courgettes, sliced, 2 cm thick	Oil, salt, pepper

¹ Add 1 tsp cornflour to raw meat/fish.

² Fairly firm

Blanching

Blanch vegetables before freezing them. Blanching helps maintain the quality of the produce when it is frozen.

Blanching vegetables also helps them retain their original colour.

- Put the prepared vegetables into a perforated cooking container.
- Once blanched, plunge the vegetables into ice cold water to cool them down quickly. Drain them well.

Settings

Further  | Special applications | Blanching

or

Steam cooking 

Temperature: 100 °C

Blanching time: 1 minute

Bottling

Only use unblemished, fresh produce which is in good condition for bottling.

Glass jars

Use clean glass jars and accessories and check them for any defects. Glass jars with twist off lids or glass lids with a rubber seal are suitable.

Make sure that all the jars are the same size so that bottling is carried out evenly.

After you have filled the jars with the bottled produce, clean the glass rims with a clean cloth and hot water and then seal the jars.

Fruit

Sort fruit carefully, rinse it briefly but thoroughly and allow it to drain. Take great care when cleaning soft fruit as it is very delicate and squashes easily.

Remove any peel, stalks, cores or stones. Cut up large fruit. For example, cut apples into slices.

If you are bottling fruit with stones (e.g. plums, apricots) without removing the stones, pierce the fruit several times with a fork or wooden skewer as otherwise it will burst.

Further applications

Vegetables

Rinse, clean and cut up vegetables.

Vegetables should be blanched before bottling to help them retain their colour (see “Special applications” – “Blanching”).

Fill volume

Fill the glass jars with produce up to a maximum of 3 cm below the rim. Do not pack it down as this will damage the cell walls of the produce. Tap the jar gently onto a cloth to help distribute the contents evenly. Fill the jars with liquid. The produce must be completely covered.

Use a sugar solution for fruit and a salt or vinegar solution for vegetables.

Tips

- Make use of residual heat by leaving the jars in the oven for 30 minutes after it has switched off.
- Then cover the jars with a cloth and allow to cool for approx. 24 hours.

Bottling food

- Place a perforated container or the rack in level 1.
- Place the jars in the perforated container or on the rack. The jars must not touch each other.

Settings

Further  | Special applications | Bottling or

Steam cooking 

Temperature: see chart

Duration: see chart

Further applications

The durations specified in the chart are guidelines only.

Food to be bottled	🌡️ [°C]	🕒* [min]
Berries		
Currants	80	50
Gooseberries	80	55
Cranberries	80	55
Fruit with stones		
Cherries	85	55
Mirabelle plums	85	55
Plums	85	55
Peaches	85	55
Greengages	85	55
Fruit with pips		
Apples	90	50
Apple sauce	90	65
Quinces	90	65
Vegetables		
Beans	100	120
Broad beans	100	120
Gherkins	90	55
Beetroot	100	60

🌡️ Temperature 🕒 Duration

* Bottling times apply to 1.0 l jars. If using 0.5 l jars, reduce the duration by 15 minutes. If using 0.25 l jars, reduce the duration by 20 minutes.

Further applications

Bottling cakes

Creamed, sponge and yeast dough mixtures are all suitable for bottling. Cakes will keep for approx. 6 months.

Cakes **made with fresh fruit** are **not suitable for long term storage**, and must be consumed within 2 days of being made.





Only use sterilised jars and accessories. The jars must be narrower at the bottom than at the top (mason jars). 0.25 l jars are the best for this purpose.

Jars must have a glass lid with a rubber ring and metal spring clamp to seal them.



Make sure that all the jars are the same size so that the preserving process is carried out evenly.

- Grease the inside of the jars with butter up to 1 cm below the rim.
- Sprinkle fine breadcrumbs inside the jars.
- Fill the jars $\frac{1}{2}$ to $\frac{2}{3}$ full with mixture (depending on recipe). Make sure the rim stays clean.
- Place the rack in shelf level 1.
- Place the **open** jars (all the same size) on the rack. The jars must not touch each other.
- Close the jars **immediately** after bottling by clamping the glass lid down securely. Do not let the cakes cool down. If the mixture has risen above the rim, it can be pushed back down into the jar with the glass lid.

The durations specified in the chart are guidelines only. We recommend selecting the shorter duration initially. You can extend the duration if necessary.

Type of mixture	Function	Stage	🌡️ [°C]	ΔΔ [%]	🕒 [min]
Batter		–	160	–	35–45
Sponge		–	160	–	50–55
Yeast dough		1	30	100	10
		2	160	30	30–35

🌡️ Temperature, ΔΔ Moisture, 🕒 Duration

 Conventional heat,  Combination cooking + Conventional heat

Drying food

Only use the Drying special application or the Combi mode  | Combi Fan plus function to dry food so that moisture can be dissipated.

- Cut the food into similar sized pieces.
- Spread out across the rack covered in baking parchment.

Tip: Bananas and pineapple are not suitable for drying.

Settings

Further  | Special applications | Drying

Temperature: see chart

Drying time: see chart

or



Combi mode  | Combi Fan plus

Temperature: see chart

Moisture: 0 %

Drying time: see chart

The durations specified in the chart are guidelines only. We recommend selecting the shorter drying time initially. You can make the drying time longer if necessary.

Food	 [°C]	 [h]
Apple, rings	70	6–8
Apricots, halved, stones removed	60–70	10–12
Pears, sliced	70	7–9
Herbs	60	1.5–2.5
Mushrooms	70	3–5
Tomatoes, sliced	70	7–9
Citrus fruit, sliced	70	8–9
Plums, stones removed	60–70	10–12

 Temperature,  Duration (hours)

Further applications

Prove dough

- Prepare the dough according to the recipe.
- Place the dough in an uncovered bowl in a perforated container or on the inserted rack.
Depending on the size of the bowl, you can also place the rack on the floor of the oven compartment with the rack surface facing up and place the bowl on top. If necessary, you can also remove the side runners.

Settings

Further  | Special applications | Prove dough

or

Steam cooking 

Temperature: 30 °C

Moisture: 100 %

Duration: as per recipe instructions

Disinfect items

The steam oven can be used to disinfect baby bottles and other containers so that at the end of the programme they are as germ free as they would have been had they been boiled. Check beforehand that all parts, teats etc. are declared by the manufacturer to be heat resistant to 100 °C and also that they can withstand hot steam.

Dismantle, clean and thoroughly rinse baby bottles. All parts of the bottles must be completely dry before they are reassembled to keep them germ free.

- Place the individual items on the rack or in a perforated container (on their sides or with the opening facing downwards) ensuring that they do not touch one another to allow hot steam to reach them from all sides.

Settings

Further  | Special applications | Disinfect items

Duration: 1 minute to 10 hours

or

Steam cooking 

Temperature: 100 °C

Duration: 15 minutes

Heat crockery

If the crockery is pre-heated, the food does not cool down as quickly.

Use heat-resistant crockery.

- Place the rack on shelf level 2 and place the crockery to be pre-heated on it. Depending on the size of the crockery, you can also place the rack on the floor of the oven compartment with the rack surface facing up and the crockery on top. If necessary, you can also remove the side runners.
- Select Further  | Special applications.
- Select Heat crockery.
- Alter the recommended temperature if necessary and then set the time.

 Risk of injury caused by hot surfaces.

The steam oven gets hot during operation. You could burn yourself on the heater elements, oven compartment, side runners or accessories. Droplets of water may have accumulated underneath the crockery. Use oven gloves when removing the crockery from the oven.

Keeping warm

You can keep food warm in the oven compartment for up to 2 hours.

In order to maintain the quality of food, select the shortest possible time.

- Select Further  | Special applications.
- Select Keeping warm.
- Place the food to be kept warm in the oven compartment and confirm with *OK*.
- Alter the recommended temperature if necessary and then set the time.

Further applications

Heating damp flannels

- Moisten the flannels and then roll them up.
- Place them beside one another in a perforated cooking container.

Settings

Automatic programmes  | Special | Heat damp flannels

or

Steam cooking 

Temperature: 70 °C

Cooking duration: 2 minutes

Dissolve gelatine

- Soften **gelatine leaves** by leaving them in a bowl of cold water for 5 minutes. The gelatine leaves have to be fully covered with water. Remove the gelatine leaves from the bowl and squeeze them out. Empty the bowl. Place the squeezed gelatine leaves back in the bowl.
- Place **gelatine powder** in a bowl and add water according to the instructions on the packaging.
- Cover the bowl and place in a perforated container.

Settings

Automatic programmes  | Special | Dissolve gelatine

or

Steam cooking 

Temperature: 90 °C

Cooking duration: 1 minute

Decrystallise honey

- Loosen the lid and place the jar of honey in a perforated container.
- Stir the honey once during the cooking duration.

Settings

Automatic programmes  | Special | Decrystallise honey

or

Steam cooking 

Temperature: 60 °C

Cooking duration: 90 minutes (irrespective of the size of jar or the amount of honey in the jar)

Melt chocolate

You can use the steam oven for melting any type of chocolate.

When using a cake covering, place it in a perforated cooking container, leaving it in its packaging.

- Break the chocolate into small pieces.
- Place larger quantities in a solid cooking container and smaller quantities in a cup or a bowl.
- Cover the container or the dish with a lid or with foil that is resistant to temperatures up to 100 °C and to hot steam.
- Stir large quantities once halfway through cooking.

Settings

Automatic programmes  | Special | Melt chocolate

or

Steam cooking 

Temperature: 65 °C

Cooking duration: 20 minutes

Further applications

Make yoghurt

To make yoghurt, you will need either fresh live yoghurt or yoghurt culture, obtainable from health food shops.

Use natural yoghurt with live culture and without additives. Heat-treated yoghurt is not suitable.

The yoghurt must be fresh (short storage time).

You can use either unchilled long-life milk or fresh milk.

Long-life milk can be used as it is – no further preparation is required. Fresh milk must first be heated to 90 °C (do not boil it) and then cooled down to 35 °C. Fresh milk will give a better set than long-life milk.

The yoghurt and milk should have the same percentage fat.

Do not move or shake the jars whilst the yoghurt is thickening.

Immediately after preparation, leave the yoghurt to cool in the fridge.

How well home-prepared yoghurt sets will depend on the consistency, fat content and the cultures used in the starter yoghurt. Not all yoghurts are suitable for use as starter yoghurt.

Tip: When using yoghurt enzyme, yoghurt can be made from a milk / cream mixture. Mix $\frac{3}{4}$ litre milk with $\frac{1}{4}$ litre cream.

- Mix 100 g yoghurt with 1 l milk or make up the mixture with yoghurt enzyme, following the instructions on the packaging.
- Pour the mixture into jars and seal the jars.
- Place the sealed jars into a perforated cooking container or on the rack. The jars must not touch each other.
- Straight after the cooking duration has finished, place the jars in the refrigerator. Take care not to shake the jars unnecessarily.

Settings

Automatic programmes  | Special |
Make yoghurt

or

Steam cooking 
Temperature: 40 °C
Duration: 5 hours

Possible reasons for unsatisfactory results

Yoghurt has not set:

Incorrect storage of starter yoghurt, too much time out of the refrigerator, e.g. in transportation, damaged packaging, milk not sufficiently heated.

Liquid has separated:

The jars were moved, yoghurt was not cooled down quickly enough.

Yoghurt is gritty:

Milk was overheated or in poor condition, milk and starter yoghurt not evenly stirred.

Cook bacon

The bacon does not brown.

- Place the bacon (diced or rashers) in a solid cooking container.
- Cover the container with foil that is temperature-resistant up to 100 °C and resistant to steam.

Settings

Automatic programmes  | Special |
Render fat

or

Steam cooking 

Temperature: 100 °C

Cooking duration: 4 minutes

Sweat onions

Sweating means cooking the onions in their own juices, with the addition of a little fat if necessary.

- Cut the onions up into small pieces and place them in a solid cooking container with a little butter.
- Cover the container with foil that is temperature-resistant up to 100 °C and resistant to steam.

Settings

Automatic programmes  | Special |
Sweat onions

or

Steam cooking 

Temperature: 100 °C

Cooking duration: 4 minutes

Further applications

Extracting juice with steam

This appliance is ideal for extracting juice from soft, firm and hard fruit.

It is best to use overripe fruit, as the riper the fruit, the greater the quantity of juice produced. Very ripe fruit will also produce a more intense flavour.

Preparation

Sort and clean the fruit. Cut out any blemishes.

Remove the stalks from grapes and morello cherries as these are bitter. Berries do not need to have their stalks removed.

Cut larger fruit such as apples into chunks of approximately 2 cm in size. The harder the fruit, the smaller the pieces should be.

Tips

- Try experimenting with mild and tart fruit.
- Adding sugar will increase the quantity of juice produced and improve the flavour. Sprinkle the fruit with sugar and leave to absorb for a few hours before juicing. For 1 kg of sweet fruit add 50–100 g of sugar, and for 1 kg of tart fruit add 100–150 g of sugar.
- If you wish to bottle the juice rather than consume it straight away, pour it whilst hot into hot, sterilised bottles, and then seal immediately with sterilised tops.

Extracting juice from fruit

- Put the prepared fruit into a perforated cooking container.
- Place a solid cooking container or the universal tray underneath in order to collect the juice.

Settings

Steam cooking 

Temperature: 100 °C

Duration: 40–70 minutes

Fruit preserve

Only use unblemished, fresh produce which is in good condition.

Glass jars

Only use sterilised jars with twist-off lids up to a maximum capacity of 250 ml.

After pouring in the fruit, clean the rim of the jar with a clean cloth and hot water.

Preparation

Sort fruit carefully, rinse it briefly but thoroughly and allow it to drain. Take great care when cleaning soft fruit as it is very delicate and squashes easily. Remove any stalks, cores or stones.

Purée the fruit as otherwise the preserve will not set. Add jam sugar to the fruit (according to packet instructions) and stir well.

For sweet fruit and berries you should also add some citric acid.

Making fruit preserve

- Fill jars maximum 2/3 full.
- Place the jars without their lids on in a perforated container or on the rack.
- At the end of the cooking duration, take the jars out of the steam oven using oven gloves. Leave them to stand for 1–2 minutes before sealing them with lids and then leave them to cool.

Settings

Combi mode  | Combi Fan plus

Temperature: 150 °C

Moisture: 0 %

Duration: 35–45 minutes

Further applications

Skinning vegetables and fruit

- Cut a cross in the top of tomatoes, nectarines etc. This will allow the skin to be removed more easily.
- Place the fruit/vegetables in a perforated cooking container if using steam cooking and on the universal tray if using the grill.
- To blanch almonds, it is important to plunge them into cold water as soon as they are taken out of the oven. Otherwise the skin cannot be removed.

Settings

Further  | Full grill

Level: 3

Duration: see chart

Food	 [min]
Peppers	10
Tomatoes	7

 Duration

Settings

Steam cooking 

Temperature: 100 °C

Duration: see table

Food	 [min]
Apricots	1
Almonds	1
Nectarines	1
Peppers	4
Peaches	1
Tomatoes	1

 Duration

Apple storage

You can treat homegrown apples in the steam oven to increase the length of time for which you can store them. Once treated, the apples will keep for 5 to 6 months when stored in a dry, cool and well-ventilated place. This method is only suitable for apples and not for other types of fruit.

Settings

Automatic programmes  | Fruit | Apples | Whole

or

Steam cooking 

Temperature: 50 °C

Preserving time: 5 minutes

Making eierstich

- Mix 6 eggs with 375 ml milk (do not beat into a foam).
- Season the egg and milk mixture and pour into a solid cooking container greased with a little butter.

Settings

Steam cooking 

Temperature: 100 °C

Cooking duration: 4 minutes

Automatic programmes

The wide range of automatic programmes enables you to achieve excellent results with ease.

Categories

The **Auto** automatic programmes are sorted into categories to provide a better overview. Simply select the appropriate programme for the type of food you are cooking and follow the instructions in the display.

Using automatic programmes

- Select Automatic programmes **Auto**.

A list will appear in the display.

- Select the desired food category.

The automatic programmes available for the food category selected will then appear.

- Select the desired automatic programme.
- Follow the instructions in the display.

Tip: Use **i** Info to display information such as how to place or turn the food depending on the cooking programme.

Usage notes

- The degree of cooking and browning are represented by a bar with seven segments. You can set the desired degree of cooking or browning using the navigation area.

- The weights specified in the automatic programmes refer to the weight per piece. For example, you can cook just one piece of salmon weighing 250 g or 10 pieces of salmon, each weighing 250 g, at the same time.
- The steam oven compartment needs to cool to room temperature before starting an automatic programme.
- When you place food into the hot oven compartment, be careful when opening the door. Hot steam may escape. Step back and wait until the steam has dissipated. Avoid contact with hot steam, and do not touch the hot oven compartment walls. Danger of burning and scalding.
- Please refer to the cookbook for information on suitable baking containers.
- For some automatic programmes, the start time can be delayed using **Start at** or **Ready at**. The individual cooking stages of the automatic programme are listed under the **Show cooking stages** menu option.
- If by the end of an automatic programme the food is not cooked enough for your taste, select **Continue cooking** or **Continue baking**.
- Automatic programmes can also be saved as **User programmes**. To do this, select the **↶** sensor control after an automatic programme has finished.

You can create and save up to 20 of your own programmes.

- You can combine up to 9 cooking stages to accurately programme your favourite or most frequently used recipes. In each cooking stage, you can select settings such as the function, temperature and cooking duration.
- You can enter the name of the programme for your recipe.

When you call up and start your programme again, it will run automatically.

There are different ways of creating a user programme:

- At the end of an automatic programme or special application, save it as a user programme.
- Save a cooking programme after running it with a set cooking duration.

Then enter a programme name.

Creating user programmes

- Select User programmes .
- Select Create programme.

You can now specify the settings for the first cooking stage.

Follow the instructions on the display:

- Select and confirm the settings you want.

If you select the Pre-heat function, first complete the first cooking stage. Use Add cooking stage to then add another cooking stage where you set a cooking duration. Only then can you save or start the programme.

- If required, select Further parameters to switch the Booster and Crisp function functions on or off.
- Select Finish cooking stage.

All settings for the first cooking stage have now been set.

You can add more cooking stages, for example, if you want to add another cooking function to follow on from the first.

- If additional cooking stages are required, select Add cooking stage and proceed as per the first cooking stage.

If you want to check the settings or to change them at a later date, select the cooking stage in question.

- When you have finished setting all the cooking stages, select Save.
- Enter the programme name.
- Select ✓.

User programmes

A message will appear on the display confirming that the programme name has been saved.

- Confirm with *OK*.

You can start the saved programme immediately, delay the start or change the cooking stages.

Starting user programmes

- Place the food in the oven compartment.
- Select User programmes .
- Select the programme you want to use.
- Select *Allow*.

Depending on the programme settings, the following menu options appear on the display:

- Start now
The programme will start immediately. The oven heating will switch on immediately.
- Finish at
Specify the time you want cooking to stop. The oven heating will switch off automatically at the time you have set.
- Start at
Specify the time you want the programme to start. The oven heating will switch on automatically at the time you have set.
- Show cooking stages
A summary of your settings will appear on the display.

- Display actions
The required actions, e.g. placing the food in the oven, will appear on the display.
- Select the menu option you want.

The programme selected will begin straight away or at the time set.

Use  *Info* to display information such as how to place or turn the food depending on the cooking programme.

- At the end of the programme, select the  sensor control.

Changing cooking stages

Cooking stages in automatic programmes that have been saved under a different name cannot be changed.

- Select **User programmes** .
- Select the programme you want to change.
- Select **Change programme**.
- Select the cooking stage that you want to change or **Add cooking stage** to add another cooking stage.
- Select and confirm the desired settings.
- If you want to start the modified programme without changing it, select **Start programme**.
- Select **Save** when you have changed all the settings.

A message will appear in the display confirming that the programme name has been saved.

- Confirm with **OK**.

The saved programme has been changed and you can start it immediately or delay the start.

Changing the name

- Select **User programmes** .
- Select the programme you want to change.
- Select **Change name**.
- Change the programme name.
- Select **✓**.

A message will appear in the display confirming that the programme name has been saved.



- Confirm with **OK**.

The programme has been renamed.

Deleting user programmes

- Select **User programmes** .
- Select the programme you want to delete.
- Select **Delete programme**.
- Confirm the request with **Yes**.

The programme is deleted.

Go to **Further**  | **Settings**  | **Factory default** | **User programmes to delete all user programmes at the same time.**

Baking

Handling food carefully will help protect your health.

Cakes, pizzas and french fries should be cooked until golden, not dark brown.

Baking tips

- Set a cooking duration. When baking, the oven should not be set to start a long time off. Otherwise the cake mixture or dough will dry out, and the raising agents will lose their effectiveness.
- Generally speaking, you can use racks, universal trays and any type of baking tray made of heat-resistant material.
- Always place baking tins on the rack.
- Always cook frozen goods such as cakes, pizza or baguettes on the rack.

Very high temperatures can cause the universal tray to distort to such an extent that the tray cannot be taken out of the oven compartment.

- Small items of frozen food such as oven chips or potato croquettes can be cooked on the universal tray. Turn these frozen food items several times during cooking.
- Bake on a maximum of 2 levels at the same time. When baking cakes with a moist topping, only bake on one level.

Using baking parchment

Miele accessories, e.g. the universal tray, are treated with PerfectClean (see "Cleaning and care"). Surfaces treated with PerfectClean generally do not need to be greased or covered with baking parchment.

■ Use baking parchment when cooking:

- lye mixtures because anything prepared using a lye containing sodium hydroxide can damage the PerfectClean surface
- mixtures with a high egg white content, such as sponge, meringue and macaroons, as these can easily stick
- puff pastry or strudel dough
- frozen food on the rack
- small items of frozen food such as oven chips or potato croquettes on the universal tray

Tips on baking

- Dark tins are best for baking. Avoid using bright, thin-walled tins as they give an uneven or poor browning result. In certain unfavourable conditions, the food will not cook properly.
- Position rectangular tins with the longer side across the width of the oven compartment for optimum heat distribution and even baking results.
- When cooking frozen food such as chips, croquettes, cakes, pizza and baguettes, select the medium temperature quoted on the manufacturer's packaging.
- If a range is specified for the cooking duration, check whether the food is cooked after the shortest duration. Stick a wooden skewer into the food. If it comes out clean without any batter/dough on it, the food is done.

Notes on the functions

You can find an overview of all the functions with their recommended values in "Main and sub-menus".

Combi mode

This function uses a combination of oven heat and moisture. The addition of steam prevents the surface of the food from drying out. Bread, bread rolls and puff pastry have a shiny and crispy crust.

You can choose between different types of heating:

- Combi Fan plus
- Combi Conventional
- Combi Grill

We recommend baking bread and bread rolls in several cooking stages: the shine is created during the first cooking stage thanks to the injection of steam (maximum moisture, low temperature). Browning takes place in the next cooking stage with high moisture and a high temperature. It is then dried with reduced moisture and a medium to high temperature.

Tip: Recipes and comprehensive cooking charts with information on functions, temperatures, moisture and cooking durations can be found in the Miele combination steam oven cookbook

Baking

Automatic programmes

Please refer to the cookbook for information on suitable baking containers.

Follow the instructions on the display.

Fan plus

Use this function if you are baking on multiple shelves at the same time.

You can use any type of baking tin made of heat-resistant material.

Because the fan distributes the heat around the oven compartment straight away, it allows you to use a lower temperature than you would with the Conventional heat function.

Conventional heat

Use this function for baking traditional recipes. If using an older recipe or cookbook, set the oven temperature 10 °C lower than the recommended one. This will not change the cooking duration.

Only bake on one level. If you are making a tray bake, use level 2.

Intensive bake

This function is suitable for baking cakes with moist toppings, pizza, quiche, etc.

Place the food on shelf level 1.

Bottom heat

Use this function towards the end of cooking to brown the base of the food.

Top heat

Use this function towards the end of cooking to brown the top of the food.

This function is suitable for gratins and for browning bakes.

Cake plus

Use this function for baking batter and frozen lye mixtures.

Eco Fan heat

This function is suitable for making sweet and savoury bakes and gratins in a way that saves energy.

Tips for roasting

- Frozen meat must be defrosted before it is cooked as otherwise it would dry out. Always defrost meat before roasting.
- Remove skin and sinew before roasting.
- Marinate and season the meat to taste.
- If you are cooking several pieces of meat together, use pieces that are similar in size.
- Use the universal tray with the rack placed on top of it. The oven compartment stays cleaner and you can then use the meat juices collected to make a gravy or sauce.

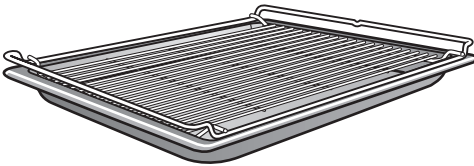

- Allow a standing time of approx. 10 minutes before carving meat. This resting time ensures the meat juices are distributed evenly.

Notes on the functions

You can find an overview of all the functions with their recommended values in “Main and sub-menus”.

Combi mode

This function uses a combination of oven heat and moisture. The addition of steam prevents the surface of the food from drying out. The results are particularly tender and succulent meat with a well-browned outside. Use the Combi mode  function for cooking meat, fish and poultry dishes.

You can choose between different types of heating:

- Combi Fan plus
- Combi Conventional
- Combi Grill

We recommend cooking meat slowly and gently in several cooking stages: at a high temperature during the first cooking stage to brown the surface. The second cooking stage requires increased moisture and a reduced temperature. The meat cooks evenly and the muscle protein is broken down, making the meat particularly tender.

Tip: Recipes and comprehensive cooking charts with information on functions, temperatures, moisture and cooking durations can be found in the Miele combination steam oven cookbook .

Roasting

Automatic programmes

Follow the instructions on the display.

Fan plus

This function is suitable for roasting meat and poultry that needs to be well browned.

Because the fan distributes the heat around the oven compartment straight away, it allows you to use a lower temperature than you would with the Conventional heat function.

Conventional heat

Use this function for baking traditional recipes. If using an older recipe or cookbook, set the oven temperature 10 °C lower than the recommended one. This will not change the cooking duration.

Use the Bottom heat function towards the end of the cooking duration to brown the base of the food.

Do not use the Intensive bake function for roasting as the juices will become too dark.

 Risk of injury caused by hot surfaces.

If you open the appliance door during grilling, the control elements will get very hot.

Keep the door closed during the grilling programme.

Grilling tips

- Pre-heating is not necessary when grilling. Place the food in the cold oven compartment.
- Use the universal tray with the rack placed on top of it. Exception: If you are grilling on level 3, insert the universal tray one level down from the rack.



- When grilling fish, place the fish on a piece of baking paper cut to size.
- Grill thick food, e.g. half a chicken, on level 2 and thin food, e.g. steaks, on level 3.
- Turn the food $\frac{2}{3}$ of the way through the cooking duration. Exception: fish does not need to be turned.

Tips for grilling

- Marinate lean meat or brush it with oil. Do not use other types of fat as they can burn and cause smoke.
- Pierce sausages before grilling.
- It is best to grill food of a similar thickness at the same time so that the grilling time for each item does not vary too greatly.
- To **test the food**, press down on the meat with a spoon. This lets you determine how well the meat has been cooked.
 - **Rare/pink**
If the meat gives easily to the pressure of the spoon, it will still be red on the inside.
 - **Medium**
If there is some resistance, the inside will be pink.
 - **Well done**
If there is very little resistance, it is cooked through.
- To grill thicker pieces of food more gradually after an initial high temperature, continue grilling at a lower temperature setting or use a lower shelf level to allow the food to cook through to the centre.

Grilling

Notes on the functions

You can find an overview of all the functions with their recommended values in “Main and sub-menus”.

Combi Grill

This function is suitable for grilling food that should be brown on the outside, but not dry, e.g. corn on the cob.

Full grill

Use this function to grill flat thin cuts in large quantities and for browning large baked dishes.







Economy grill

Use this function to grill flat thin cuts in smaller quantities and for browning small baked dishes.

Fan grill

This function is suitable for grilling thicker food, such as poultry or rolled meat.

Test food according to EN 60350-1 (steam cooking functions)



Test food	Cooking con- tainers	Quantity [g]	 ³ ₁		 ¹ [°C]	 [min]
Steam replenishment						
Broccoli (8.1)	1x DGGL 12	max.	2		100	3
Steam distribution						
Broccoli (8.2)	1x DGGL 20	300	2		100	3
Appliance capacity						
Peas (8.3)	2x DGGL 12	1500 each	1, 2		100	<u>2</u>



³ Level,  Function,  Temperature,  Cooking duration

 Steam cooking,  Eco steam cooking

- 1 Place the test food in a cold oven compartment (before the heating-up phase begins).
- 2 The test is finished when the temperature measures 85 °C in the coolest place.

Menu cooking test food¹ (steam cooking function















Test food	Cooking con- tainers	Quantity [g]	 ³ ₁ ²	 [°C]	Height [cm]	 [min]
Potatoes, waxy, quartered ³	1 x DGGL 20	800	3	100	–	17
Salmon fillet, frozen, not defrosted	1 x DGGL 20	4 x 150	1	100	< 2.5 ≥ 2.5 ≤ 3.2 > 3.2	9 10 11
Broccoli florets	1 x DGGL 20	600	2	100	–	4

³ Shelf level,  Temperature,  Cooking duration

- 1 For instructions, see “Steam cooking – Menu cooking”.
- 2 Place the universal tray on shelf level 1.
- 3 Place the first test food item (potatoes) in the cold oven compartment (before the heating-up phase begins).

Note for test institutes

Test food according to EN 50304/EN 60350-1 (oven functions)

Test food	Accessories	 ³		 [°C]	 ² [min]		Pre-heat- ing
Shortbread biscuits (7.5.2)	1 baking tray	2		140	34–36 (34)	No	No
	2 baking trays	1		140	39–41 (40)	No	No
		3 ¹			36–38 (37)		
	1 baking tray	2		140	29–31 (28)	Yes	Yes
Small cakes (7.5.3)	1 baking tray	1		150	35–37 (37)	No	No
	2 baking trays	1, 2		140	44	No	No
Whisked sponge (7.6.1)	1 springform cake tin 26 cm (on rack)	2		160	30	Yes	Yes
Apple sponge (7.6.2)	1 springform cake tin 20 cm (on rack)	2		160	95–105 (100)	No	No
	2 springform cake tins 20 cm (on rack)	2		160	85–95 (90)	Yes	Yes
Industrially produced white bread (9.2)	Rack	2		Level 3	5	No	6 min.
Burger (9.3)	Rack	3		Level 3	1st side: 10 2nd side: 6	No	8 min.
	Universal tray	2					

³ Level,  Function,  Temperature/grill level, ² Cooking duration,  Booster
 Fan plus,  Conventional heat,  Cake plus,  Full grill

- 1 Take the trays out of the oven early if the food is sufficiently browned before the specified cooking duration has elapsed.
- 2 The value in brackets states the optimum cooking duration.

Important information on cleaning and care

 Risk of injury caused by hot surfaces.

The steam oven gets hot during operation. You could burn yourself on the heater elements, oven compartment, side runners or accessories.

Allow the heater elements, oven compartment, side runners and the accessories to cool before manual cleaning.

 Risk of injury due to electric shock.

The steam from a steam cleaning appliance could reach live electrical components and cause a short circuit.

Do not use a steam cleaner to clean the steam oven.

Surfaces can discolour or alter if unsuitable cleaning agents are used. The front of the steam oven is particularly susceptible to damage from oven cleaners and descaling agents. All surfaces are susceptible to scratching. Scratches on glass can in some circumstances lead to breakage.

Remove all cleaning agent residues immediately.

Stubborn soiling could damage the steam oven in certain circumstances. Once the oven has cooled, clean the oven compartment, the inside of the door and the door seal. Waiting too long can make cleaning unnecessarily difficult and in some cases impossible.

Do not use commercial cleaning agents. Only use agents designed for domestic use.

Do not use cleaning agents or washing-up liquids containing aliphatic hydrocarbons as these could cause the seals to swell.

- The steam oven and accessories should be cleaned and dried thoroughly after each use.
- Leave the appliance door open until the oven compartment is completely dry.

If the steam oven is not going to be used for a longer period of time, it should be thoroughly cleaned and dried beforehand to prevent the build-up of odours and so on. Leave the door open afterwards.

Cleaning and care

Unsuitable cleaning agents

To avoid damaging the surfaces of your appliance, do not use:

- Cleaning agents containing soda, ammonia, acids or chlorides
- Cleaning agents containing descaling agents
- Abrasive cleaning agents, e.g. powder cleaners and cream cleaners
- Solvent-based cleaning agents
- Stainless steel cleaning agents
- Dishwasher cleaner
- Glass cleaning agents
- Cleaning agents for ceramic glass hobs
- Hard, abrasive brushes or sponges (e.g. pot scourers, brushes or sponges which have been previously used with abrasive cleaning agents)
- Melamine eraser blocks
- Sharp metal scrapers
- Wire wool
- Stainless steel spiral pads
- Spot cleaning with mechanical cleaning agents
- Oven cleaners or sprays

Cleaning the steam oven front

- Clean the appliance front with a clean, soft sponge and a solution of warm water and washing-up liquid.
- After cleaning, wipe the surfaces dry using a soft cloth.

Tip: A clean, damp microfibre cloth without cleaning agent can also be used.

PerfectClean

The oven compartment, side runners, universal tray and combi rack surfaces are **treated with PerfectClean**. This finish has an iridescent appearance. PerfectClean surfaces have very good anti-stick properties and are easy to clean.

However, it is important to clean the surfaces each time the oven is used. The non-stick properties will deteriorate if soiling is not removed from PerfectClean surfaces after each use. If used frequently without being cleaned, cleaning may become very difficult.

Soiling such as spilt juices and cake mixtures are best removed whilst the oven compartment is still warm.

Spilt fruit juices may cause discolouration to the surfaces that cannot be removed. However, this does not affect the properties of the PerfectClean finish.

Always remove all cleaning agent residues to protect the non-stick properties.

To protect the non-stick effect of PerfectClean surfaces, please avoid:

- abrasive cleaning agents (e.g. powder cleaners, scouring milk, scouring pads)
- cleaning agents for ceramic glass hobs
- ceramic glass and stainless-steel cleaners
- steel wool
- abrasive sponges, e.g. pot scourers or sponges which have been previously used with abrasive cleaning agents
- oven spray
- spot cleaning with mechanical cleaning agents

Do **not** clean PerfectClean accessories in the dishwasher.

Cleaning and care

Oven compartment

The surface of the oven compartment has been treated with PerfectClean.

Please see “PerfectClean” in the “Cleaning and care” chapter for instructions on cleaning.

Ensure that no cleaning agent gets into the openings on the oven compartment rear panel.

To make cleaning the oven compartment easy, you can remove the oven door, dismantle the side runners and lower the top heat/grill element.

Cleaning after a programme using steam

■ Remove:

- condensate using a sponge or absorbent cloth
- light, greasy soiling with a clean sponge and a solution of washing-up liquid and hot water

■ After cleaning, wipe the surface with clean water to remove any cleaning agent residues.

■ Then dry the oven compartment and the inside of the door with a cloth.

Tip: You can then leave the steam oven to dry automatically (see “Care” in the “Cleaning and care” chapter).

Cleaning after a roasting, grilling or baking programme

Clean the oven compartment thoroughly after roasting, grilling and baking as otherwise soiling can burn on and become impossible to remove.

- Clean the oven compartment and inside of the door with a clean dishwashing sponge, hot water and a little washing-up liquid. You can use the hard surface of a dishwashing sponge to clean the oven compartment if necessary.
- After cleaning, wipe the surface with clean water to remove any cleaning agent residues.
- Then dry the oven compartment and the inside of the door with a cloth.

Tip: Soaking the soiling for a few minutes with a solution of washing-up liquid and hot water can make cleaning easier. Alternatively, run the Further Maintenance | Soak programme (see “Care” in the “Cleaning and care” chapter).

Cleaning the floor filter

- The filter in the floor of the oven should be cleaned and dried after every use.
- Vinegar can be used to remove discolouration and limescale deposits from the filter in the floor of the oven. Rinse thoroughly with clean water afterwards.

Cleaning the door seal

The door seal may become brittle and tear on account of contact with grease residues.

Clean the door seal between the inside of the oven door and the oven compartment after every baking or roasting programme.

- Clean the door seal using a clean, damp microfibre cloth without any cleaning agent. You can also use a clean sponge and warm water with a little washing-up liquid.
- After cleaning dry the seal with a soft cloth.
- Replace the seal with a new one if it becomes porous or brittle.

Door seals can be ordered from the Miele Customer Service Department (see the end of these operating instructions for contact details).

Cleaning the water container and condensate container

The water container and condensate container are suitable for cleaning in a dishwasher.

- Remove the water container and condensate container after every use. Remove the water container and condensate container by pushing them upwards slightly.
- Empty the water container and condensate container.

Water can drip into the water container and condensate container compartment when removing the containers.

- Dry the compartment if necessary.
- Rinse the water container and condensate container by hand or in the dishwasher.
- Then dry the water container and condensate container with a cloth to prevent limescale.

Cleaning and care

Accessories

Cleaning the universal tray and combi rack

The surfaces of the universal tray and the combi rack have been treated with PerfectClean. Please see “PerfectClean” in the “Cleaning and care” chapter for instructions on cleaning.

- Remove:
 - light soiling with a clean sponge and a solution of washing-up liquid and hot water
 - stubborn soiling with a clean dish-washing sponge, hot water and a little washing-up liquid. If necessary, you can also use the rough side of the sponge.
- After cleaning, wipe the surface with clean water to remove any cleaning agent residues.
- Then dry the surfaces using a cloth.

Cleaning cooking containers

The cooking containers are suitable for cleaning in a dishwasher.

- Wash and dry the cooking containers after each use.
- Any bluish discolouration on cooking containers can be removed with vinegar. Rinse with clean water.

Cleaning the side runners

The surfaces of the side runners have been treated with PerfectClean. Please see "PerfectClean" in "Cleaning and care" for notes on cleaning.

 Risk of injury caused by hot surfaces.

The steam oven gets hot during operation. You could burn yourself on the heating elements, oven compartment or accessories.

Allow the heater elements, oven compartment and accessories to cool before removing the side runners.

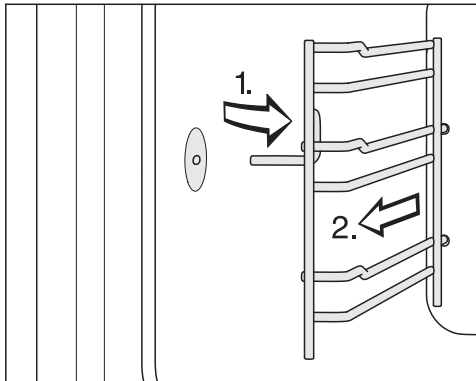

- Pull the side runners out of the holder (1.) from the front and remove them (2.).

- Remove:

- light soiling with a clean sponge and a solution of washing-up liquid and hot water,
- stubborn soiling with a clean dish-washing sponge and a solution of washing-up liquid and hot water. You can use the abrasive side of the dish-washing sponge if necessary.

- After cleaning, wipe the surface with clean water to remove any detergent residues.

- Then dry the side runners with a soft cloth.

Reassemble by following these instructions in reverse order.

- Refit the side runners carefully.

If the side runners are not correctly inserted, there is no anti-tip protection. Also, the temperature sensor could be damaged when cooking containers are placed in the steam oven.

Cleaning and care

Lowering the top heat/grill element

If the oven compartment roof is badly soiled, the top heat/grill element can be lowered by approx. 5 cm to make cleaning easier.

 Risk of injury caused by hot surfaces.

The steam oven gets hot during operation. You could burn yourself on the heater elements, oven compartment, side runners or accessories. Allow the heater element, oven compartment, side runners and the accessories to cool before cleaning.

Be careful not to damage the top heat/grill element.

Never use force when pulling down the top heat/grill element.

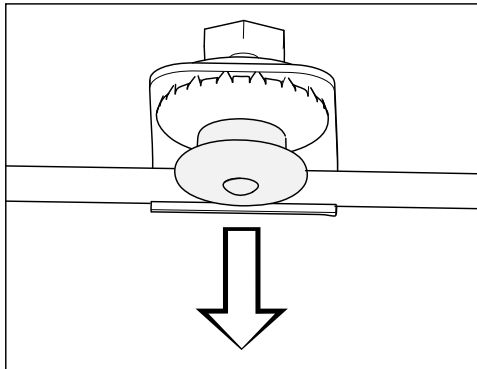

- Carefully pull down the pressure cap. The top heat/grill element then lowers automatically.

- Clean the oven compartment roof with a sponge cloth or a dishwashing sponge (see “Oven compartment” in the “Cleaning and care” chapter).
- After cleaning the top heat/grill element, push the pressure cap back up. Make sure the pressure cap engages correctly.

Maintenance

The Finish at and Start at functions are not available with maintenance programmes.

Soak

Stubborn soiling can be soaked using this maintenance programme.

- Allow the oven compartment to cool down.
- Remove all accessories from the oven.
- Remove coarse soiling with a cloth.
- Select Further  | Maintenance | Soak.

The soaking process takes approx. 10 minutes.

Drying

This maintenance programme can be used to dry any residual moisture in the oven compartment, including in inaccessible areas.

- Dry the oven compartment with a cloth.
- Select Further  | Maintenance | Drying.

The drying process takes approx. 20 minutes.

Rinsing

The water-carrying system is rinsed out during this maintenance programme. Any remaining food deposits are rinsed away.

- Select Further  | Maintenance | Rinse.
- Follow the instructions on the display.

The rinsing process takes approx. 10 minutes.

Descaling the steam oven

We recommend using Miele descaling tablets (see “Optional accessories”) to descale the appliance. These have been specially developed for use with Miele appliances to optimise the descaling process. Other descaling agents, which contain other acids besides citric acid and/or other undesirable substances, such as chlorides for example, could cause damage to the product. Moreover, the descaling result required could not be guaranteed if the descaling solution was not of the appropriate concentration.

Do not spill descaling agent onto metal surfaces. This can cause marks to appear.

However, should any descaling agent get onto these surfaces, wipe it away immediately.

The steam oven has to be descaled after a certain number of operating hours. When the time comes to descale it, the number of uses remaining lights up in the display. It only counts the number of uses that use steam. The steam oven will be disabled after the last remaining cooking process.

We recommend that you descale the appliance before it locks out.

During the descaling process, the water container must be rinsed out and re-filled with fresh water. The condensate container needs to be emptied.

Cleaning and care

- Switch the steam oven on and select **Descal** .

The message **Please wait** will appear on the display. The descaling process is being prepared. This may take several minutes. As soon as the appliance is ready you will be prompted to fill the water container.

- Fill the water container with lukewarm water up to the level marker  and drop 2 Miele descaling tablets in it.
- Wait until the descaling tablets have dissolved.
- Push the water container into the appliance.
- Confirm with **OK**.
- Empty the condensate container.
- Confirm with **OK**.

The time left will appear on the display. The descaling process will now begin.

Do not switch the steam oven off during the descaling process, otherwise the whole process will have to be started from the beginning again.

The water container will need emptying and refilling with fresh tap water twice during descaling. The condensate container needs to be emptied.

- Follow the instructions on the display.
- Confirm each with **OK**.

Once the time left has elapsed, **Empty the condensate container** will appear on the display.

- Follow the instructions on the display.
- Confirm with **OK**.

The descaling process is complete.

- Remove the water container and condensate container and empty them as required.
- Clean and dry the water container and condensate container.
- Open the door and let the oven compartment cool down.
- Then dry the oven compartment.
- Leave the appliance door open until the oven compartment is completely dry.
- Switch the steam oven off.

Door removal

- Prepare a suitable underlay for the door, such as a soft cloth.
- Open the door a fraction.

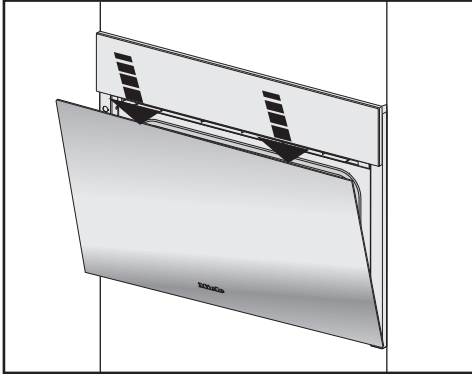

- Using both hands press down on the top edge of the door briefly.

The oven door is connected to the door hinges by retainers. Before removing the door from the retainers, the locking clamps on both door hinges have to be released.

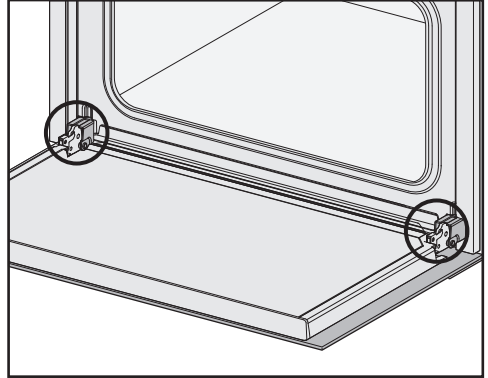

- Open the door fully.

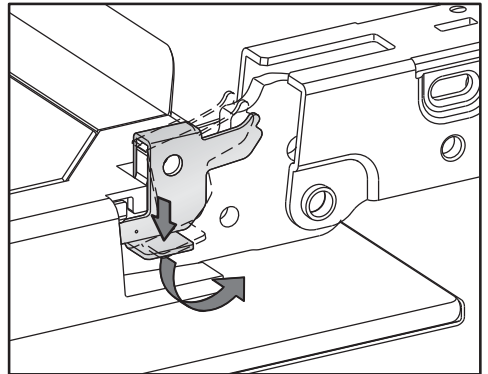

- Release the locking clamps on the hinges by turning them upwards as far as they will go until they are at an angle.

The steam oven could become damaged if you incorrectly remove the door.

Never pull the door horizontally off its retainers, as they will spring back against the steam oven.

- Raise the door up until it rests partially open.

Cleaning and care

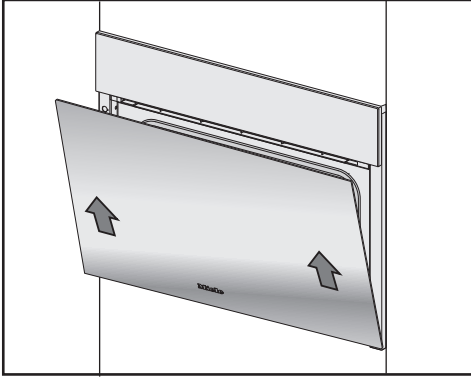

- Hold the door securely at both sides and lift it evenly upwards off the hinge retainers. Make sure that the door is straight.
- Place the door on the previously prepared surface.

If the locking clamps are not locked, the door could become loose, resulting in damage.
Always ensure that the locking clamps are locked after refitting the door.

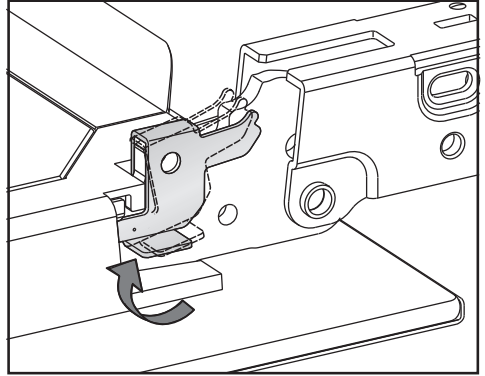

Fitting the door

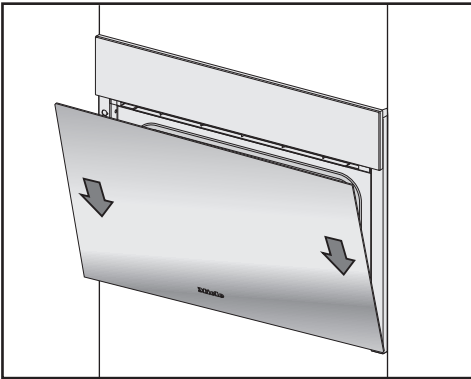

- Hold the door securely on both sides and carefully fit it back into the door hinge retainers. Make sure that you fit the door straight.
- Open the door fully.

- To relock the locking clamps, turn them back up to the horizontal position as far as they will go on both door hinges.



Problem solving guide

Many malfunctions and faults that can occur in daily operation can be easily remedied. Time and money will be saved because a service call will not be needed.

The following guide may help you to find the reason for a malfunction or a fault, and to correct it.

Problem	Cause and remedy
<p>You cannot switch the appliance on.</p>	<p>The fuse has tripped.</p> <ul style="list-style-type: none"> ■ Reset the trip switch in the fuse box or replace the fuse in the plug (see data plate for minimum fuse rating).
	<p>There may be a technical fault.</p> <ul style="list-style-type: none"> ■ Disconnect the appliance from the mains connection for approximately 1 minute by: <ul style="list-style-type: none"> – Tripping the relevant mains fuse or unscrewing the fuse completely, or – Switching off the residual current protection device ■ If, after resetting the trip switch in the mains fuse box or the residual current protection device, the steam oven will still not turn on, contact a qualified electrician or Miele Service.
<p>The oven compartment does not heat up.</p>	<p>Demo mode is active. The steam oven can be operated, however, the heating elements will not work.</p> <ul style="list-style-type: none"> ■ Deactivate demo mode (see “Settings – Show-room programme”).
	<p>The oven compartment has been warmed up by a warming drawer in operation underneath it.</p> <ul style="list-style-type: none"> ■ Open the door and let the oven compartment cool down.
<p>The fan can still be heard after the appliance has been switched off.</p>	<p>The fan is still running. The appliance is fitted with a fan which removes steam from the oven. The fan will continue to run for a while after the appliance has been switched off. It will switch itself off automatically after a while.</p>

Problem solving guide

Problem	Cause and remedy
<p>The sensor controls do not respond.</p>	<p>You have selected the Display QuickTouch Off setting. So when the steam oven is switched off, the sensor controls do not respond.</p> <ul style="list-style-type: none"> ■ As soon as the steam oven is switched on, the sensor controls will respond. If you want the sensor controls to always respond even when the steam oven is switched off, select the Display QuickTouch On setting.
	<p>The steam oven is not connected to the power supply.</p> <ul style="list-style-type: none"> ■ Check that the steam oven plug is correctly inserted into the socket. ■ Check whether the fuse has tripped. Contact a qualified electrician or the Miele Customer Service Department.
	<p>There is a fault with the controls.</p> <ul style="list-style-type: none"> ■ Touch and hold the  On/Off sensor control until the display switches off and the steam oven restarts.
<p>The door cannot be opened.</p>	<p>You have selected the Display QuickTouch Off setting. The  sensor control does not respond when the steam oven is switched off.</p> <ul style="list-style-type: none"> ■ As soon as the steam oven is switched on, the sensor controls will respond. If you want the sensor controls to always respond even when the steam oven is switched off, select the Display QuickTouch On setting.
	<p>There may be a technical fault.</p> <ul style="list-style-type: none"> ■ If you need to open the door, e.g. because there is still food in the oven compartment, you will need to open the door manually (see end of this chapter). ■ If the problem occurs again, contact the Miele Customer Service Department.
<p>A humming sound can be heard during operation and after switching off the steam oven.</p>	<p>This noise does not indicate incorrect operation or an appliance fault. The noise is made by water being pumped through the system.</p>

Problem solving guide

Problem	Cause and remedy
After moving house, the steam oven no longer switches from the heating-up phase to the cooking phase.	<p>The boiling temperature of the water has changed as the altitude of the new location for the appliance differs from the old one by at least 300 m.</p> <ul style="list-style-type: none"> ■ To adjust the boiling temperature, you need to de-scale the appliance (see “Care” in the “Cleaning and care” chapter).
During operation an unusually large amount of steam escapes, or steam escapes from parts of the oven where it does not usually.	<p>The door is not properly closed.</p> <ul style="list-style-type: none"> ■ Close the door.
	<p>The door seal is not correctly fitted.</p> <ul style="list-style-type: none"> ■ Press it in all the way round the door to make sure it is fitted evenly.
	<p>The door seal is damaged, e.g. cracks can be seen.</p> <ul style="list-style-type: none"> ■ Replace the door seal. This can be ordered from Miele (see the end of this booklet for contact details).
The oven interior lighting is not working.	<p>The lamp is defective.</p> <ul style="list-style-type: none"> ■ Call Miele Service to have the lamp replaced.
The control panel will not open or close automatically despite touching the  sensor several times.	<p>Something is obstructing the control panel.</p> <ul style="list-style-type: none"> ■ Remove the obstruction.
	<p>The obstruction sensor is very sensitive and can prevent the panel opening or shutting if it picks up a signal.</p> <ul style="list-style-type: none"> ■ Open/close the control panel manually (see end of this section) ■ If the problem occurs again, contact Miele Service.
The <small>Start at</small> and <small>Finish at</small> functions are not available.	<p>The temperature in the oven compartment is too high, e.g. after a programme has finished.</p> <ul style="list-style-type: none"> ■ Open the door and let the oven compartment cool down.
	<p>These functions are not generally available in maintenance programmes.</p>

Problem solving guide

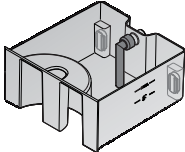
Problem	Cause and remedy
<p>Cakes and biscuits are not cooked properly after following the durations given in the recipe.</p>	<p>The temperature set is not the same as the one given in the recipe.</p> <ul style="list-style-type: none"> ■ Change the temperature. <p>The recipe has been altered. For example, adding more liquid or eggs can increase the cooking duration required.</p> <ul style="list-style-type: none"> ■ Adapt the temperature and/or cooking duration to the altered recipe.
<p>Cakes or biscuits are unevenly browned.</p>	<p>The set temperature was too high.</p> <p>More than two levels were used for baking.</p> <ul style="list-style-type: none"> ■ Bake on a maximum of two levels.
<p>F10</p>	<p>The suction tube in the water container</p> <ul style="list-style-type: none"> – is not fitted correctly. – is not positioned vertically. <ul style="list-style-type: none"> ■ Connect it properly and make sure it is vertical: 
<p>F11 F20</p>	<p>The drain hoses are blocked.</p> <ul style="list-style-type: none"> ■ Descalcify the steam oven (see “Care” in the “Cleaning and care” chapter). ■ If the fault message appears again, contact Miele Service.
<p>F44</p>	<p>Communication fault</p> <ul style="list-style-type: none"> ■ Switch the steam oven off and then back on again after a few minutes. ■ If the same message appears again, call the Service Department.
<p>F55</p>	<p>The maximum operating time for a cooking function has been exceeded. This has triggered the safety switch off device.</p> <ul style="list-style-type: none"> ■ Switch the steam oven off and then back on again. <p>The steam oven is immediately ready for use again.</p>

Problem solving guide

Problem	Cause and remedy
F196	<p>There is a fault.</p> <ul style="list-style-type: none">■ Switch the steam oven off and then back on again. <p>The filter in the bottom of the oven compartment is not positioned correctly.</p> <ul style="list-style-type: none">■ Switch the steam oven off. <div data-bbox="800 422 890 510"></div> <ul style="list-style-type: none">■ Insert the filter correctly:■ Switch the steam oven back on again.■ If the fault message appears again, call Miele Service.
F and other fault codes	<p>Technical fault.</p> <ul style="list-style-type: none">■ Switch the appliance off and contact Miele.

Problem solving guide

To open the panel manually

- Carefully open the appliance door.

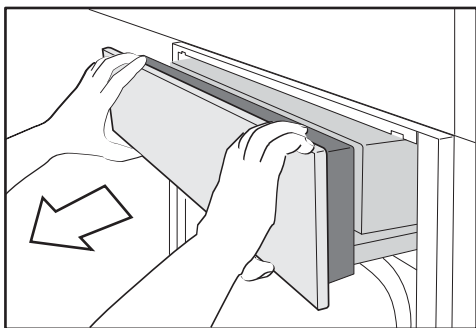

- Take hold of the panel at the top and bottom.
- Pull the panel out forwards to start with.
- Then carefully push the panel upwards.

To close the panel manually

- Take hold of the panel at the top and bottom.
- Carefully push the panel downwards.

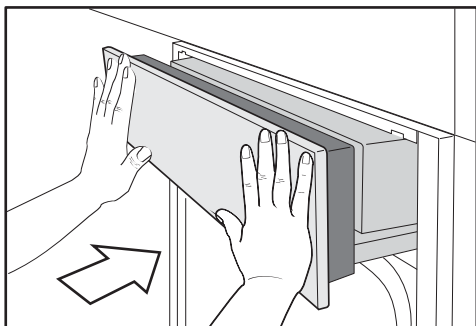

- Then push it in.

Opening the door manually

⚠ Risk of injury caused by hot surfaces.

The door glass can get hot. You can burn yourself on the door glass.

Wear oven gloves when opening the hot door.

⚠ Risk of injury caused by steam.

When using a cooking programme involving steam, a lot of steam can escape if the door is opened. The steam can cause burns.

Step back and wait until the steam has dissipated before taking the food out of the oven.

⚠ Risk of injury caused by hot surfaces and food.

The steam oven gets hot during operation. You could burn yourself on the heater elements, oven compartment, side runners, accessories, food or door glass.

Wear oven gloves when placing hot food in the oven or removing it, when adjusting oven shelves etc. in the hot oven compartment and when closing the hot door.

Wear oven gloves when taking hot food out of the oven, when adjusting oven shelves etc. in a hot oven compartment and when closing the hot door.

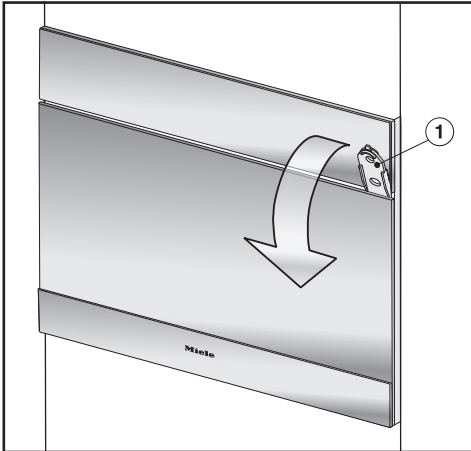

- Insert the opener supplied ① about 3 cm into the gap between the door and the control panel on the right hand side and then pull the door open.

Optional accessories

Miele offer a comprehensive range of useful accessories as well as cleaning and conditioning products for your Miele appliances.

These products can be ordered through the Miele Webshop.

They can also be ordered from Miele (see end of this booklet for contact details) or from your Miele dealer.

Containers

Miele offers a wide range of cooking containers. These have all been optimised for Miele appliances in terms of functionality and dimensions. Detailed information on each of our products can be found on the Miele website.

- Perforated cooking containers in various sizes
- Solid cooking containers in various sizes
- Gourmet oven dishes in various sizes
- Lids for Gourmet oven dishes

Other

- Baking trays
- Round baking tray
- FlexiClip runners
- Holding rack for cooking containers with a width of 325 mm

Cleaning and care products

- DGClean
Special cleaning agent for removing stubborn soiling from the oven compartment, particularly after roasting
- Descaling tablets (6)
- All-purpose microfibre cloth
For removing finger marks and light soiling

Contact in the event of a fault

In the event of any faults which you cannot remedy yourself, please contact your Miele dealer or the Miele Customer Service Department.

You can book a Miele Customer Service Department call-out online at www.miele.com/service.

Contact information for the Miele Customer Service Department can be found at the end of this document.

Please quote the model identifier and serial number of your appliance (Fabr./SN/Nr.) when contacting the Miele Customer Service Department. This information can be found on the data plate.

Please note that telephone calls may be monitored and recorded for training purposes and that a call-out charge will be applied to service visits where the problem could have been resolved as described in this booklet.

This information is given on the data plate, which is visible on the front frame of the oven when the door is fully open.

Warranty

For information on the appliance warranty specific to your country please contact Miele. See back cover for address.

In the UK, your appliance warranty is valid for 2 years from the date of purchase. However, you must activate your cover by calling 0330 160 6640 or registering online at www.miele.co.uk.

Installation

Safety instructions for installation

 Risk of damage from incorrect installation.

Incorrect installation can cause damage to the steam oven.

The steam oven must only be installed by a qualified person.

▶ The connection data (frequency and voltage) on the steam oven's data plate absolutely must correspond with those of the electricity supply in order to ensure that no damage can occur to the steam oven.

Compare this data before connecting the appliance. If in any doubt, consult a qualified electrician.

▶ Multi-socket adapters and extension leads do not guarantee the required safety of the appliance (fire hazard). Do not use them to connect the steam oven to the power supply.

▶ The socket should be easily accessible after the steam oven has been installed.

▶ The steam oven must be positioned so that you can see the contents of a cooking container placed on the top shelf level. Otherwise there is a risk of injuries or spillages of hot food.

Building-in dimensions

All dimensions are given in mm.

Installation in a tall unit

The furniture housing unit must not have a back panel fitted behind the building-in niche.

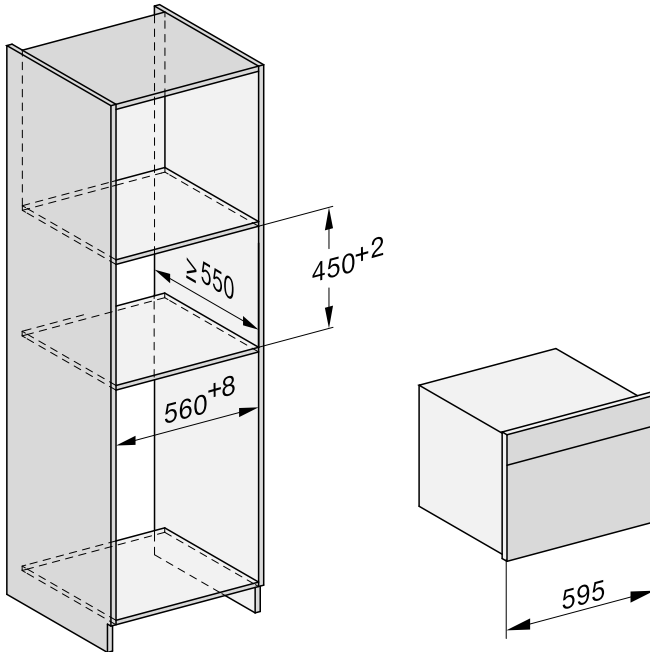

Installation

Installation in a base unit

The furniture housing unit must not have a back panel fitted behind the building-in niche.

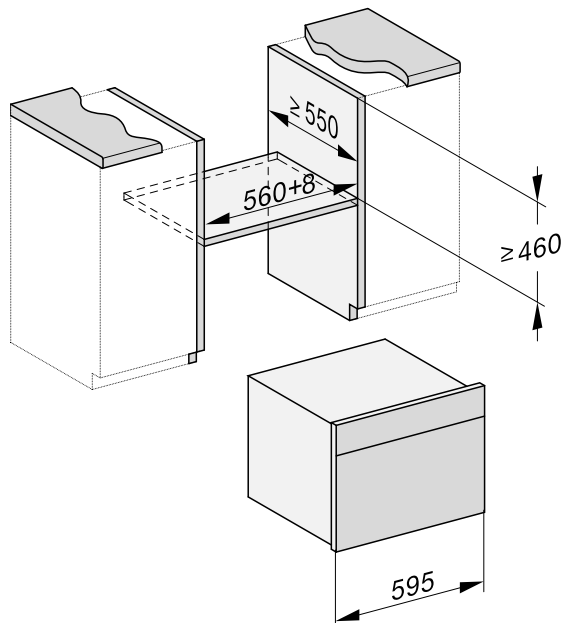

Side view

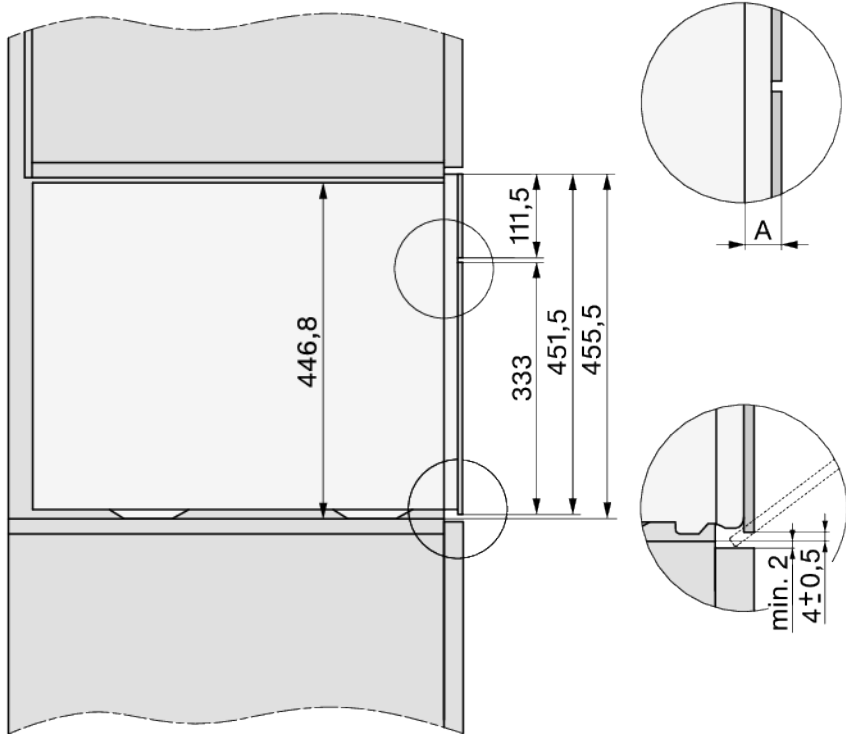

- A** Glass front: 22 mm
Metal front: 23.3 mm

Installation

Swivel range for control panel

The area in front of the control panel must not be blocked by anything that would hinder it from opening and shutting.

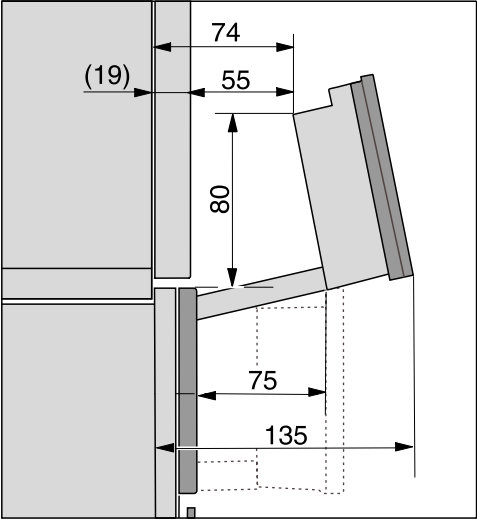

Connection and ventilation

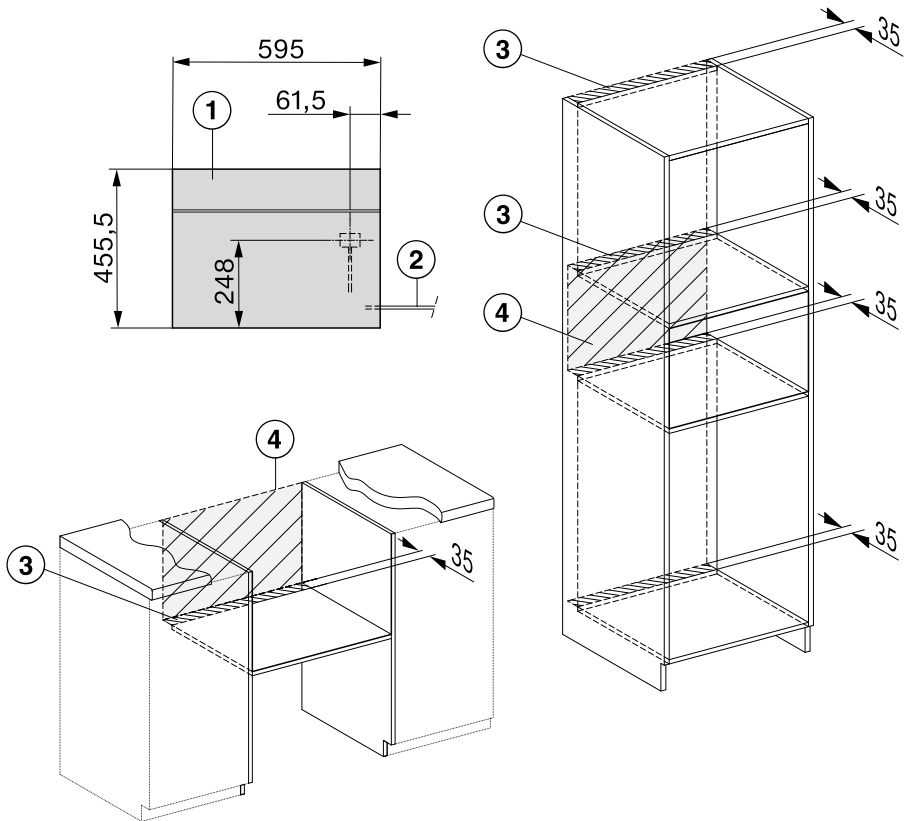

- ① Front view
- ② Mains connection cable, L = 2000 mm
- ③ Ventilation cut-out, min. 180 cm²
- ④ No connections permitted in this area

Installation

Installing the steam oven

- Connect the mains connection cable to the steam oven.

Use the handle cut-outs on the side of the casing to lift the steam oven.

The steam generator may malfunction if the steam oven is not on a level surface.
The maximum deviation from the horizontal that can be tolerated is 2°.

- Push the steam oven into the building-in niche and align it.
When doing so make sure that the mains connection cable does not get trapped or damaged.
- Open the door.

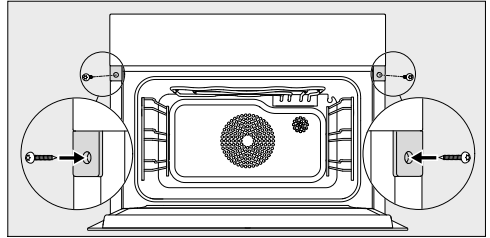

- Secure the steam oven to the side walls of the unit using the wood screws supplied (3.5 x 25 mm).
- Connect the steam oven to the electricity supply.
- Check all functions of the steam oven are working correctly in accordance with the operating instructions.

Electrical connection

We recommend that you connect the steam oven to the power supply using a suitable switched electrical socket. This makes it easier to perform servicing work. The socket must be easily accessible after the steam oven has been installed.

 Risk of damage from incorrect connection.

Installation, repairs and other maintenance work by unqualified persons could be dangerous. Miele cannot be held liable for unauthorised work. Miele cannot be held liable for damage or injury caused by the lack of or inadequacy of an on-site earthing system (e.g. electric shock).

If the plug is removed from the connection cable or if the cable is supplied without a plug, the steam oven must be connected to the electrical supply by a suitably qualified electrician.

If the socket is no longer accessible, or if a hard-wired connection is installed, an additional means of disconnection must be provided for all poles. A suitable means of disconnection would include switches with an all-pole contact gap of at least 3 mm. These include circuit breakers, fuses and contactors. The required connection data is provided on the data plate. Please ensure that these details match the electrical supply.

After installation, ensure that all electrical components are shielded and cannot be accessed by users.

Total power rating

See data plate

Connection data

The connection data is quoted on the data plate. Please ensure these match the household mains supply.

Residual current device

For extra safety, it is advisable to protect the steam oven with a suitable residual current device (RCD) with a trip range of 30 mA.

Replacing the mains connection cable

When replacing the mains connection cable, please use cable type H 05 VV-F with a suitable cross-section. These cables are available from the manufacturer or from Miele Service.

Installation

Disconnecting from the mains

 Risk of electric shock from mains voltage.

There is a risk of electric shock if the appliance is reconnected to the mains supply during repair or service work.

After disconnection, ensure the appliance cannot be switched back on by mistake.

To disconnect the appliance from the mains power supply, do one of the following depending on installation:

Safety fuses

- Completely remove the fuse links from the screw caps.

Automatic circuit breakers

- Press the test button (red) until the middle button (black) springs out.

Built-in circuit breakers

- For circuit breakers of at least type B or C, switch the lever from 1 (on) to 0 (off).

Residual current device (RCD)

- Residual current device: switch the main switch from 1 (on) to 0 (off) or press the test button.

Miele hereby declares that this Combi steam oven complies with Directive 2014/53/EU.

The complete text of the EU declaration of conformity is available from one of the following internet addresses:

- Products, Download from www.miele.co.uk
- For service, information, operating instructions etc: go to www.miele.co.uk/domestic/customer-information-385.htm and enter the name of the product or the serial number

Frequency band of the WiFi module	2.4000 GHz – 2.4835 GHz
-----------------------------------	-------------------------

Maximum transmission power of the WiFi module	< 100 mW
---	----------

United Kingdom

Miele Co. Ltd., Fairacres, Marcham Road, Abingdon, Oxon, OX14 1TW

Tel: 0330 160 6600, Internet: www.miele.co.uk/service, E-mail: info@miele.co.uk

Australia

Miele Australia Pty. Ltd.
ACN 005 635 398
ABN 96 005 635 398
1 Gilbert Park Drive
Knoxfield, VIC 3180
Tel: 1300 464 353
Internet: www.miele.com.au

China Mainland

Miele Electrical Appliances Co., Ltd.
1-3 Floor, No. 82 Shi Men Yi Road
Jing' an District
200040 Shanghai, PRC
Tel: +86 21 6157 3500
Fax: +86 21 6157 3511
E-mail: info@miele.cn,
Internet: www.miele.cn

Hong Kong, China

Miele (Hong Kong) Ltd.
41/F - 4101, Manhattan Place
23 Wang Tai Road
Kowloon Bay, Hong Kong
Tel: (852) 2610 1025
Fax: (852) 3579 1404
Email:
customerservices@miele.com.hk
Website: www.miele.hk

India

Miele India Pvt. Ltd.
Ground Floor, Copia Corporate Suites
Plot No. 9, Jasola
New Delhi - 110025
Tel: 011-46 900 000
Fax: 011-46 900 001
E-mail: customercare@miele.in
Internet: www.miele.in

Ireland

Miele Ireland Ltd.
2024 Bianconi Avenue
Citywest Business Campus
Dublin 24
Tel: (01) 461 07 10
Fax: (01) 461 07 97
E-Mail: info@miele.ie
Internet: www.miele.ie

Malaysia

Miele Sdn Bhd
Suite 12-2, Level 12
Menara Sapura Kencana
Petroleum
Solaris Dutamas No. 1
Jalan Dutamas 1
50480 Kuala Lumpur, Malaysia
Phone: +603-6209-0288
Fax: +603-6205-3768

New Zealand

Miele New Zealand Limited
IRD 98 463 631
8 College Hill
Freemans Bay, Auckland 1011
New Zealand
Tel: 0800 464 353
Internet: www.miele.co.nz

Singapore

Miele Pte. Ltd.
29 Media Circle
#11-04 ALICE@Mediapolis
Singapore 138565
sTel: +65 6735 1191
Fax: +65 6735 1161
E-Mail: info@miele.com.sg
Internet: www.miele.sg

South Africa

Miele (Pty) Ltd.
63 Peter Place
Bryanston 2194
P.O. Box 69434
Bryanston 2021
Tel: (011) 875 9000
Fax: (011) 875 9035
E-mail: info@miele.co.za
Internet: www.miele.co.za

Thailand

Miele Appliances Ltd.
BHIRAJ TOWER at EmQuartier
43rd Floor Unit 4301-4303
689 Sukhumvit Road
North Klongton Sub-District
Vadhana District
Bangkok 10110, Thailand

United Arab Emirates

Miele Appliances Ltd.
Showroom 1
Eiffel 1 Building
Sheikh Zayed Road, Umm Al Sheif
P.O. Box 114782 - Dubai
Tel. +971 4 3044 999
Fax. +971 4 3418 852
800-MIELE (64353)
E-Mail: info@miele.ae
Website: www.miele.ae

Manufacturer: Miele & Cie. KG, Carl-Miele-Straße 29, 33332 Gütersloh, Germany

DGC 7440 X

en-GB

M.-Nr. 11 181 060 / 02