

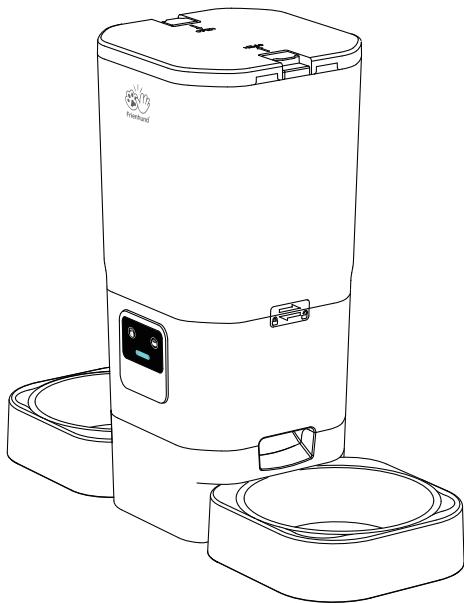

User Manual

Smart Pet Feeder with Two Bowls (2.4G/5G WiFi)
Model:ACF190W

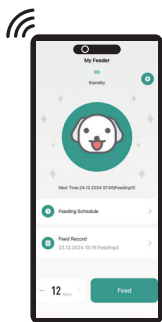

If the product is upgraded in the following please refer to the actual product in hand.

Safety Instructions



Please do not use wet, canned or moist food.



This product uses 3 × D Cell Batteries as a backup power supply. Please use double power supply to ensure the normal use of the product.



Examine the feeder after installation. Do not plug in if there is water on the power cable or plug.



Do not immerse the base part in water at any time as it may damage electronic components.



Do not disassemble the feeder other than as instructed in this user manual.



Only use accessories recommended or sold by the manufacturer. The use of accessories not recommended or sold by the manufacturer may cause an unsafe condition.



Dispose of all packaging materials properly. Some items may be packed in plastic bags, these bags could cause suffocation.

Warranty

Any questions about the use of the product, you can contact our brand after-sales staff. We will solve your problem until it is resolved.

- ◆ **1-Year Warranty**
- ◆ **24/7 Online Support**

For guidance on product use and warranty extension, please contact our brand after-sales staff via email: **support@friehund.com**
If any questions related to orders, please contact the seller through the shopping platform.

- ◆ **Monday-Friday:**
Tel: 1-877-631-3655, (PST 8:00 am-5:00pm)

- ◆ **Scan the code to view Installation Video, Wi-Fi Connection Tutorials, App Feature Descriptions.**



Product Specifications

Product Name	Smart Pet Feeder with Two Bowls (ACF190W)
Suit For	Cat, Dog, Rabbit, Small Pets, Multiple Pets
Rated Voltage	5V 1A
Product Power	5W
Power Supply	Power Adapter and 3× D Cell Batteries
Material	ECO-Friendly ABS
Product Size	180*470*400mm/7*18.5*15.75in
Product Weight	1.86kg/4.1lb
Product Capacity	7L
Pet Food	Dry Food
Portion Size	10~15g(0.02~0.03lb)

Packing List



Lid*1

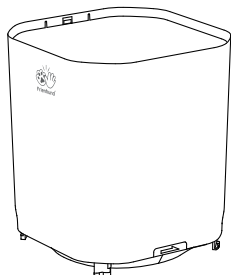

Food Tank*1

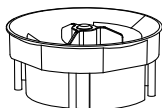

Meal Splitter*1

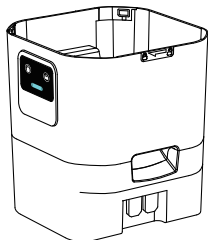

Feeder Base*1



Power Adapter*1



USB Cable*1



ABS Wall Hook*1



Anchors*4



Screws*4



Stainless Steel Feeding Bowl*2



Bowl Tray*2



User Manual*1

Product Overview

1	Lid
2	Desiccant
3	Desiccant Compartment
4	Food Tank
5	Meal Splitter
6	Control Panel
7	Food Outlet
8	Stainless Steel Feeding Bowls
9	Bowl Trays

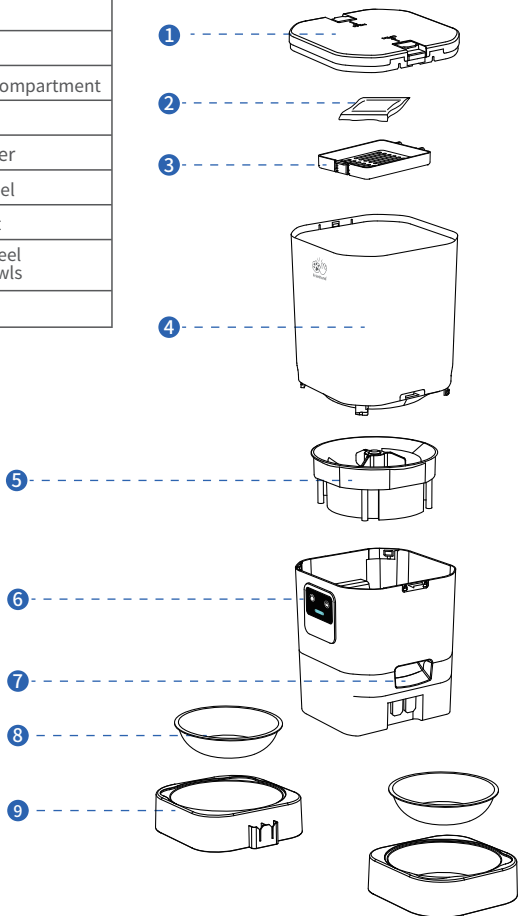

Assembled Products

Step 1 Connecting Power

1

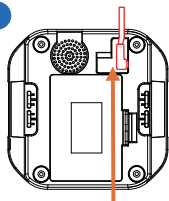

Power Cable

- Plug the 5V power adapter into the bottom of the feeder.

2

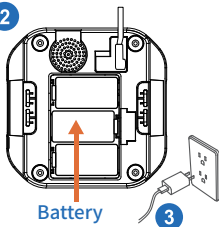

Battery

- Install 3× D Cell Batteries in the bottom of the feeder in case of power outages in the home.
- Plug in the home power supply.

4

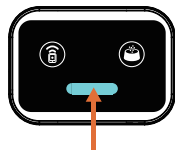

Indicator

- When the indicator is blinking blue, it means waiting for network connection.

Step2 Meal Splitter Installation

5

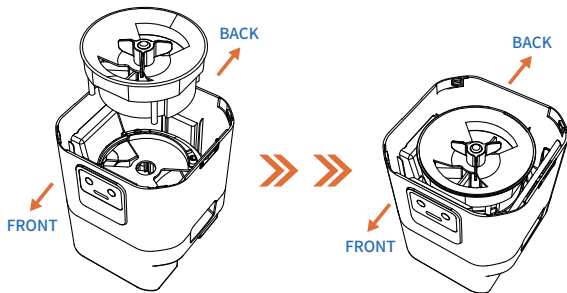

Step 3 Food Tank Installation

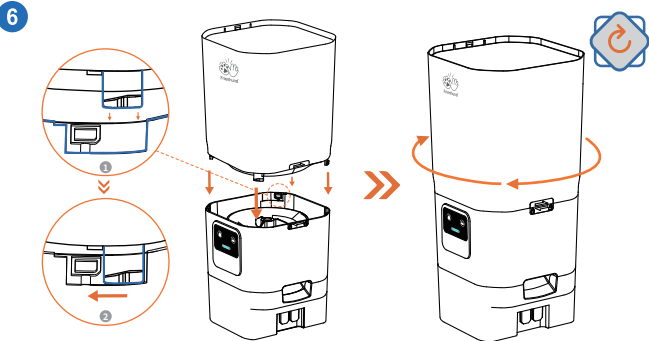

- Install as shown.
- The opening in the bottom of the food tank should match the opening in the base of the feeder, then turn clockwise to lock.

Step 4 Feeder Base Installation

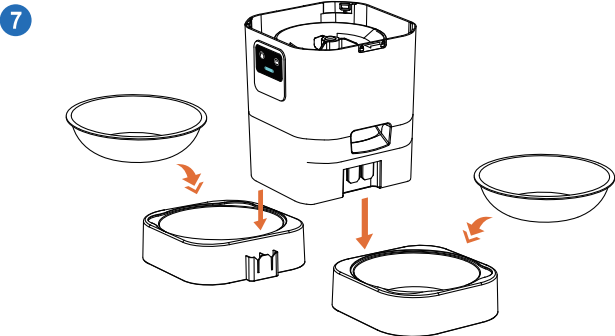

- Place the stainless steel bowl into the bowl tray.
- Insert the bowl tray into the feeder base.

Step 5 Add Food

8

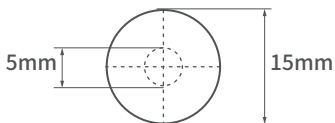
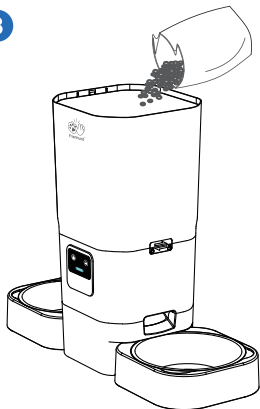

⚠ Note:

1. Please pour in dry food, not wet food or canned food.
2. Recommended food size: 5-15mm (0.19-0.59in)

9

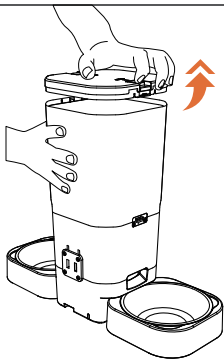
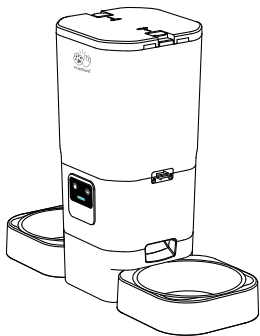

- Close the lid

Tips:

Please refer to the picture to open the feeder lid.

Step 6 Wall Hook Installation

1

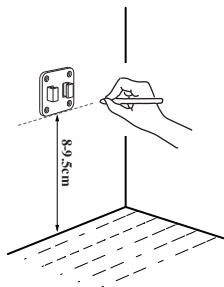

- Place the wall hook on the wall and mark the holes using a pen.

Note: The wall hook must be kept 8-9.5cm (3.15-3.75in) away from the floor.

2

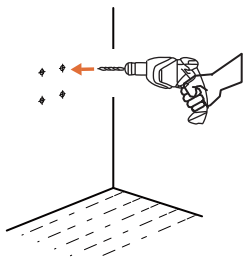

- Use an impact drill to drill the holes

Note: Use a 1/4" (6mm) diameter drill bit.

3

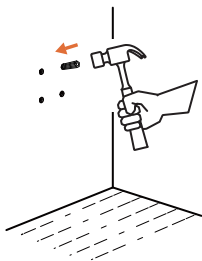

- Use a hammer to tap the plastic wall anchors plug into the hole, flush with the wall.

4

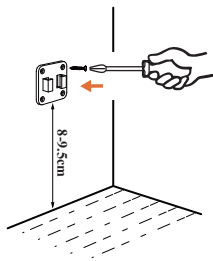

- Tighten screws to secure wall hook.

5

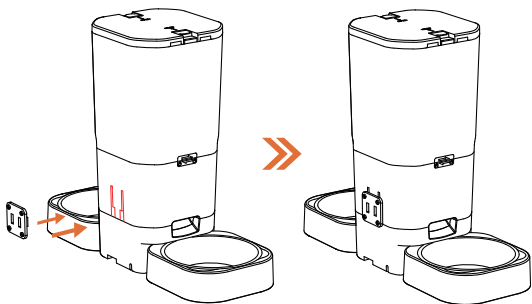

6

- Align the holes on the back of the feeder with the hooks on the wall hook and slide down.
- Installation completed.

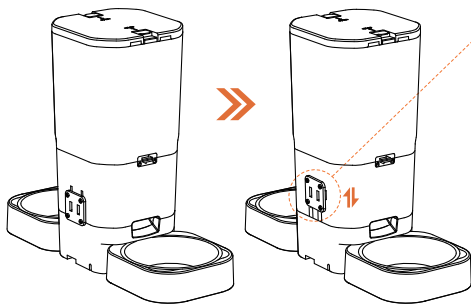



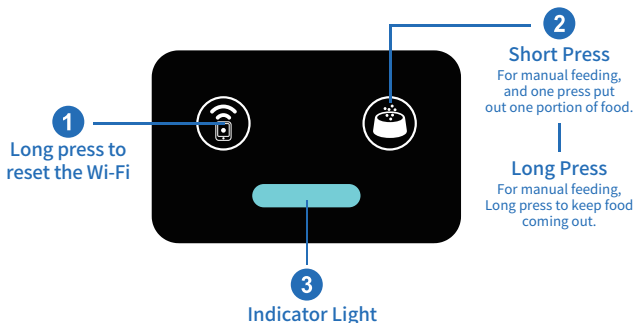

Buttons Explained

⚠ Note:

- 🔋 Battery power is only for emergency use in case of power failure, please ensure dual power supply for normal use.
- 🔋 Make sure the feeder and home WiFi are connected, the distance between the two should not be too far apart. Within 6m(19.7ft), depending on router coverage area.



Indicator Light Description

Color of Light	Status
 Blue Light Flashing	Waiting for WiFi Connection
 Blue Light Always On	WiFi Connected
 Red Light Always On	Enough Battery (Battery Powered Only)
 Red Light Flashing	Low Battery (Battery Powered Only)

Install the APP and Log In

App Installation

Scan the QR code or search in your device's app store to download and install the Smart Life app.



Smart Life



Sign up and log in

After opening the app, if you don't have an account, please register one. If you have already, please log in directly.

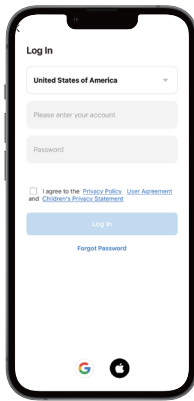

Add Feeder to APP

Step 1: Turn on phone permissions.



▲ Note:

1. Before adding the device to the APP, please make sure the indicator light on the feeder is blinking blue, as well as the **Bluetooth**, **WLAN**, and **GPS** in your phone are on.
2. Network connection is only possible when plugged in.

Step 2: The feeder is ready to connect to the network

- ◆ Turn on the power to the feeder.
- ◆ Make sure the indicator light on the feeder is flashing blue.

- 1 Please open the Smart Life APP → Tap the [+] in the upper right corner to add the device.

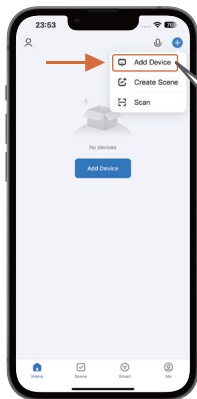

- 2 Please follow the app prompts to operate.

Method 1 Bluetooth Connection

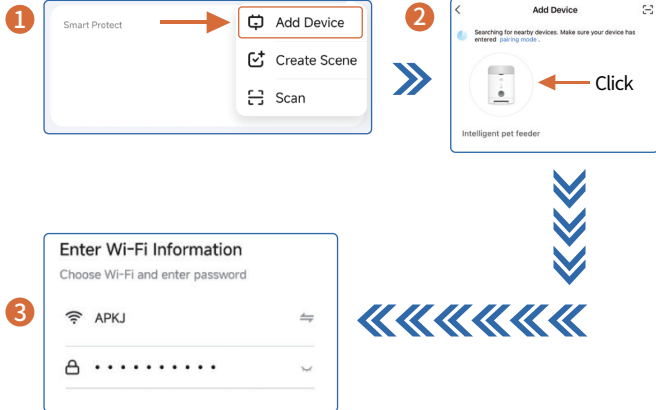

Method 2 Wi-Fi Mode Connection

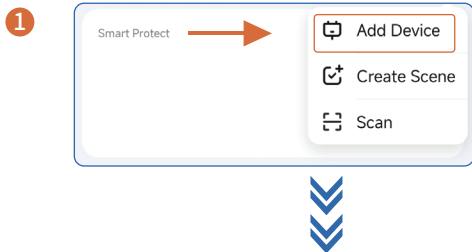

2

Small Home Appliances

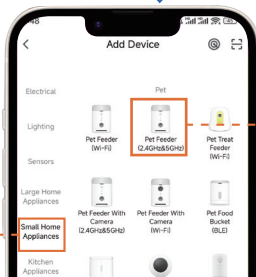

3



4

Enter Wi-Fi Information

Choose Wi-Fi and enter password



5

Reset the device



Press and hold the RESET button for 5 seconds until the indicator blinks (subject to the user manual).

Select the status of the indicator light or hear the beep:



6

Connect your mobile phone to the device's hotspot

Connect your phone to the hotspot shown below:

- WLAN
- SmartLife-XXXX
- SL-XXXX

Go back and add devices.

1 device(s) found



Intelligent pet feeder

Add

App Feature Descriptions

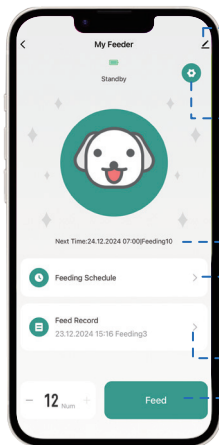

1.Settings:

- Third-party Control (**Support Alexa**)
- Share Device
- Tap-to-Run and Automation

2.Slow Feed:

When the Slow Feed function is turned on, 1 portion of food will be dispensed every 1 minute interval. (**The Slow Feed function is only active in the feeding schedule**)

3.Feeding Reminders:

The next feeding schedule.

4.Feeding Schedule:

Daily feeding schedule can be set up for up to 30 meals. (**When setting, be sure to select the date**)

5.Feed Record:

Feeding history can be viewed

6.Manual Feeding:

Up to 12 portion per click

Setting Up A Regular Feeding Schedule

Feeding Settings: You can continuously set a daily feeding schedule for your pet.

Note:

The pet feeder will operate for no more than 4 weeks on battery power alone. To ensure continuous operation, it is recommended to use a dual power supply.

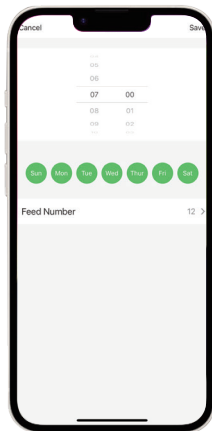

Disassemble for Cleaning

We recommend to clean the feeder regularly for the health of your pet. The washable parts of the feeder are as follows: lid, food tank, meal splitter, stainless steel feeding bowls, bowl trays.

Washable Parts



Do Not Wash

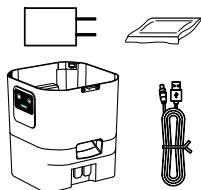

FAQ

Problem	Solution
Can't connect the feeder to WiFi	1) Make sure Bluetooth, WLAN and GPS are turned on on your phone when connecting. (Can be turned off after successful connection)
	2) Try connecting with other connections method.
	3) The WiFi network may be unstable; please attempt to connect multiple times.
	4) It is advisable to connect the device near the router (ideally within 3 meters).
	5) Consider switching to a 2.4G network connection.
	6) Troubleshoot the router to see if it is working properly (try rebooting the router)
	7) Contact us through the contact form above and we will address your questions until they are resolved.

The WiFi connection goes off line frequently

1) Make sure the feeder has a good signal within the WiFi coverage area.

2) Check that the power cord is stably connected.



THANK YOU FOR TRUSTING AND CHOOSING Frienhund

Smart Pet Feeder with Two Bowls

Model : ACF190W

Manufacturer : ShenZhen Aochen Technology Co., Ltd

Address : 306, Zhida Industrial Park2, No. 4, Longping West Road,
Shengping Community, Longcheng Street, Longgang District,
Shenzhen, China

Email : support@frienhund.com

Made in China

IC ID : 29365-S15 **FCC ID :** 2A4UI-ACF100W

If there is anything you would like to say to us

 Email: support@frienhund.com  www.frienhund.com

 Tel: **(1) 877-631-3655** (From Monday to Friday: 8 a.m.-5 p.m.)(PST)
