

BeefEater Glass-Door Tropicalised Refrigerator

User Manual

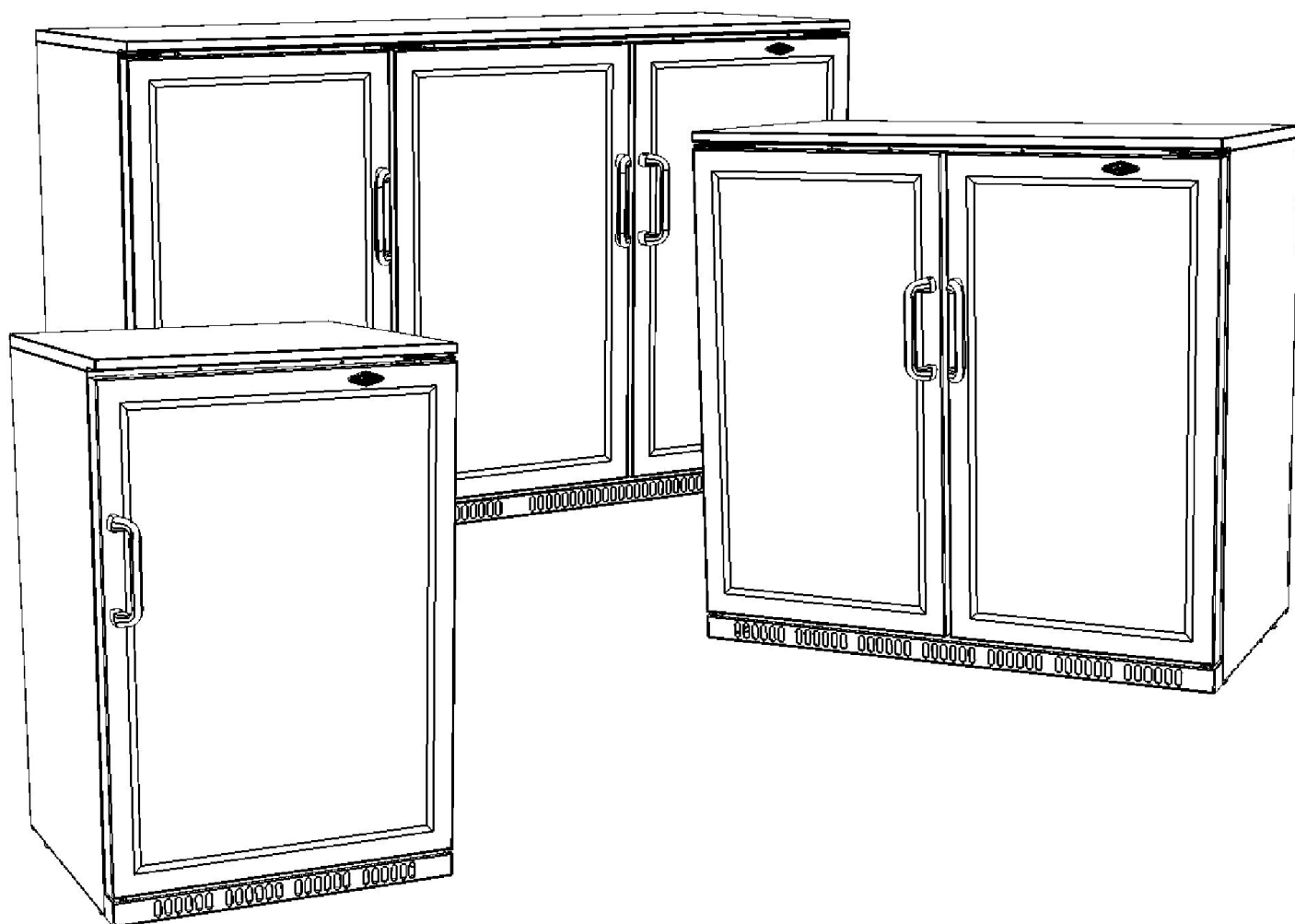

Model Numbers:

BF3310

BF2200

BF1130

To ensure safe operation, please read this instruction manual thoroughly before use.

Welcome to your new BeefEater Fridge

Thank you for purchasing this commercial style BeefEater Fridge. It has been designed and manufactured for many years of trouble-free service. It is suitable to be used outdoors, as long as it is well protected from the elements, and any direct sunlight.

Operation is very simple, but please take a few minutes to read this booklet. It contains safety information and tips to ensure you receive from your BeefEater Fridge.

Important Safety Instructions

This Refrigerator has been designed to be Built-in in a cabinet or similar "Outdoors Kitchen" arrangement. This appliance is intended to be used in household and similar applications only.

Before starting the installation, consideration should be given to how the installation is to be carried out, ensuring

- ↗ Adequate space and clearances.
- ↗ Preventing exposure to the elements.
- ↗ Preventing any exposure to direct sun light.
- ↗ Availability of earthed power.
- ↗ The mechanical strength of supporting structures.

The installation work must be undertaken by a qualified and competent person in conformity to the rules concerning connection of electric power and wiring rules.

The manufacturer does not accept any liability for any damage or injury caused by improper installation.

Before connecting to the mains supply ensure that the mains voltage corresponds with the voltage on the Refrigerator's rating label.

Make sure the electric plant of your house is correctly earthed.

When installed, the Fridge must be positioned to ensure no moisture ingress into the appliance or the appliance compartment.

- ↗ Before carrying out any kind of maintenance or cleaning, disconnect the Fridge from the mains supply.
- ↗ The appliance must not be operated or left out in the weather. Do not expose the Refrigerator to rain or wet conditions.

↗ This appliance is not intended for use by persons (including children) with reduced physical, sensory or mental capabilities, or lack of experience and knowledge, unless they have been given supervision or instruction concerning use of the appliance by a person responsible for their safety.

↗ Children should be supervised to ensure that they do not play with the appliance.

↗ If the supply cord is damaged, it must be replaced by the manufacturer, its service agent or similarly qualified persons in order to avoid a hazard.

↗ There shall be adequate ventilation of the area when the Refrigerator is used, and vents provided must be kept clear, clean and open.

↗ There is a fire risk if cleaning is not carried out in accordance with the instructions, or if damage occurs to cooling system.

↗ Always ensure the Refrigerator is kept at the correct settings for the required operation of the appliance.

↗ Do not use cooking utensils to handle things inside, or clean the interior of the fridge, as damage to liners may result.

↗ During use rear of appliance becomes hot. Care should be taken to avoid touching elements at rear of the Fridge.

↗ Children should never be allowed to sit or stand on any part of the appliance.

↗ Use this appliance only for its intended use.

↗ This appliance is intended for household use only. It is designed to be used in sheltered areas only and must not be exposed to the elements.



NOTE:

THE REFRIGERATOR MUST NEVER OPERATE IN DIRECT SUNLIGHT!











The refrigerator will not operate to specifications if sunlight penetrates the glass doors. Prolonged exposure to direct sunlight inside the fridge will result in increased temperature, excessive energy consumption, and even premature component failure, and will not be covered by warranty.

Please also Note:

Before switching your BeefEater Fridge on for the first time, read the information in this user manual carefully. This manual contains important information relating to the assembly, operation and maintenance of the appliance.

Please keep this booklet in a safe place for future reference. If you ever sell your BeefEater Fridge, hand this user manual to the new owner.

The manufacture does not accept responsibility for any damages that may arise due to non-observation of these instructions. The user is liable for any material damage or bodily injury (product liability) cause by using the refrigerator carelessly or failing to follow instructions.

-  Do not use damaged appliance. If you are in any doubt, consult a suitably qualified technician.
-  Connection and installation of your BeefEater Fridge are to be carried out in strict compliance with the instructions in this manual.
-  For safety, the appliance must be properly earthed in accordance with specifications
-  Do not damage any parts of the appliance which carry refrigerant by piercing, perforating, crushing, twisting or scraping. If the refrigerant comes into contact with the eyes, it may cause serious eye injury.
-  Always remember to unplug the appliance before cleaning. Never unplug your appliance by pulling on the power cable. Always grip plug firmly and pull straight out from the socket. Always check that the plug and cable are undamaged.
-  All repairs must be carried out by a qualified technician. Inadequate repairs may be dangerous. Never try to repair the refrigerator yourself.
-  Should the cover of the interior light or fan fall off or break, switch the refrigerator off immediately and replace the cover.
-  Ensure your chosen location has a flat and stable surface. The unit may be leveled by turning either or both of the adjustable feet in the front corners. Check the unit is level using a spirit level.
-  Do not obstruct or cover the ventilation aperture.
-  Make sure there is a suitable power Outlet (240 volts, 10 amps outlet) with proper grounding to power the refrigerator.

Disposal of Old Appliances

Be sure to make any locks unusable, remove any door(s) and discard separately.

Warning – chemical hazard: do not allow children to play with the old appliance.

Contact your local authority for disposal procedures.

Before disposing of an old appliance, please make sure it is switched off and safe. Unplug the appliance and break any locks in order to avoid children becoming trapped.

Please note: refrigeration system contains gas and refrigerants which require specialised waste disposal. Some vulnerable materials in a refrigerator can be recycled .Contact your local waste disposal depot for proper disposal of an old appliance and contact your local authority or dealer if you have any questions.

Please ensure the cooling systems and tubes of your refrigerator are not damaged prior to disposal. You can contribute to environmental awareness by insisting on an appropriate non-polluting method of disposal.

Disposal of Packaging

Do not allow children to play with the packaging, and dispose of plastic bags safely.

The cardboard may be broken or cut into smaller pieces and recycled. Any wrapping cover is made of polyethylene. The polyethylene pads and padding contain no fluorochloric hydrocarbons, and as such are most suitable for adequate recycling .

Before Using For the First Time

Do not position this appliance with its rear panel directly against a wall. For good circulation and operating efficiency, the ventilation grilles must never be blocked.

Remove all packaging and place the BeefEater Fridge on a stable, secure flat surface. Position the BeefEater Fridge away from heat sources, where the unit is well-ventilated and protected from moisture, or extremes of heat or cold. The refrigerator may not function properly if the ambient temperature rises above +40 for prolonged periods of time.

When installed in a BeefEater Outdoor Kitchen, ensure the vents behind the fridge are clear, and clean, and not obstructed from the other side, such that air circulation is enabled.

Do Not Use An Extension Lead. If the mains cable will not reach the nearest socket, either rearrange your installation layout or ask a qualified electrician to fit a new socket.

If power is cut off, wait for at least 5 minutes before plugging the unit in again to avoid damaging the compressor.

Do not place combustible, explosive or volatile articles, corrosive acid or alkali, or liquid in glass containers into the BeefEater Fridge. Always exercise caution if adjusting the temperature.



IMPORTANT: allow the refrigerator to stand still and upright for 8 hours before plugging it into the power!

Preparation

Position the Shelf-Supports inside the racks on the sides as illustrated below, at your required level, and then place the shelves firmly on the supports.

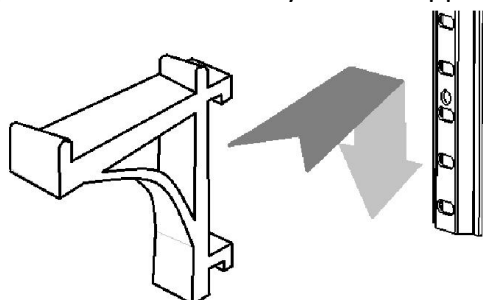

Note: check that the refrigerator is functioning correctly before installing shelves and filling it.

The maximum load for a shelf is 40Kg.

Cleaning

1. Unplug your BeefEater Fridge from power source and remove any items from inside. It is best to place these temporarily in another refrigerator.
2. Wash the inner compartment with warm water and neutral mild detergent. DO NOT allow the control panel, cables or plug to get wet.



NEVER use corrosive detergents, wire blasters, or abrasive scourers to clean your BeefEater Fridge.



NEVER use metal or sharp implements to scrape any part of the fridge.

3. Dry all surface thoroughly.
4. To ensure trouble-free operation the condenser should be cleaned every three months where appropriate using a vacuum hose. The condenser is located behind lower grill of the cabinet. In exceptionally dusty





It is recommended that areas around the condenser are cleaned more often.

5. Use mild soapy water to clean the gasket and seals around the door.
6. The external surfaces of the fridge can be cleaned with warm water and mild detergent, or with a suitable Stainless-Steel cleaning material.

Electronic Control

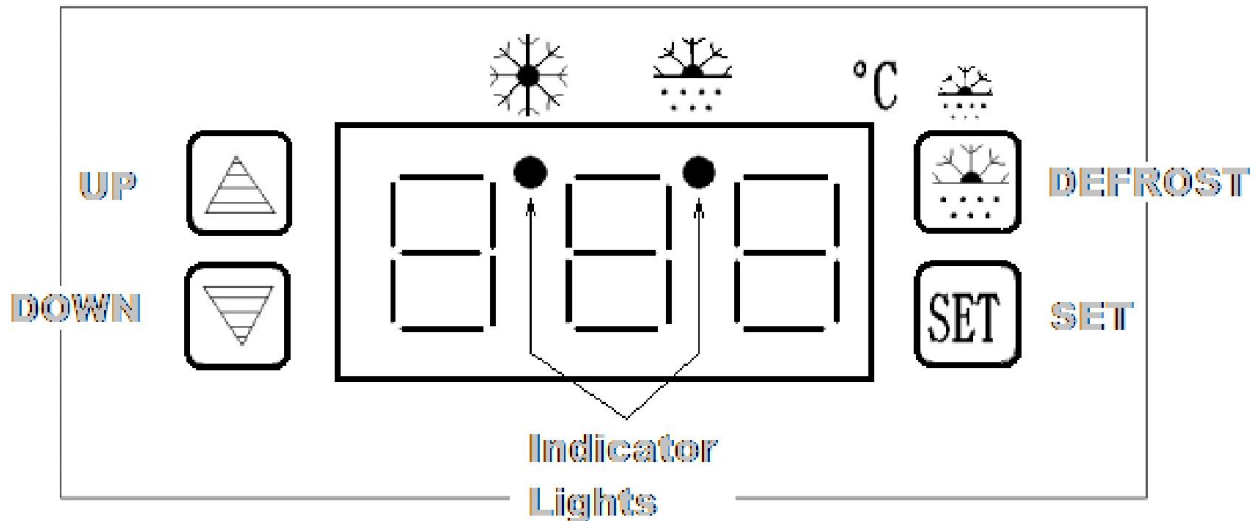
The electronic controller is located outside the unit on the bottom, right-hand side front plinth. It looks like this:





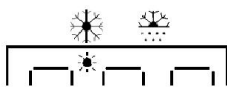

During normal operation the controller display  will show the temperature inside the refrigerator.

A small indicator light  will illuminate under the 'Cooling' symbol to confirm the fridge is in its normal cooling mode, and compressor is running.

Operation of the controller:

- To set the desired temperature of the fridge:

- Press the  button once. A 'beep' will sound, and the display will start to flash.
- Use the   buttons to set to the desired temperature.
- Press  again to complete the operation, or just leave it for 5 – 10 sec, and the display will revert back to showing internal temperature, while new settings saved.

Note:



The fridge is built to automatically defrost and prevent any ice forming on the Evaporator. It will automatically run a 'Defrost cycle for 20min once every 8 hours.

When in a 'Defrost' cycle, the indicator light will illuminate under the 'Defrost' symbol:

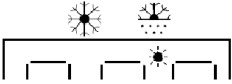

- **To manually activate 'Defrost' cycle:**

- Press the  button, and hold it. a 'beep' will sound as soon as pressed.
- Hold button pressed for 10 – 20 seconds, until a second 'beep' can be heard.
- The indicator light will now illuminate under the 'Defrost' symbol  and the fridge is into a 'Defrost' cycle.
- 'Defrost' will run for 20min, and then automatically revert to normal operation.

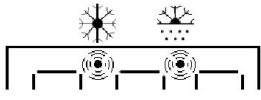

- **To manually change back to normal operating mode from the 'Defrost' mode:**

- Press the  button again, a 'beep' will sound.
- Hold button pressed for 10 – 20 seconds, until a second 'beep' is heard.
- Both indicator lights under the 'Defrost' symbol and under the 'Cooling' symbol will now

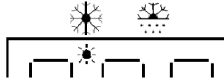
flash  while the fridge is gearing up to switch back to normal operation.

- After 5 – 20 minutes, only the indicator light  will illuminate under the 'Cooling' symbol to confirm the fridge is back in its normal cooling mode.

Important:

-  The fridge will go through a normal periodical defrosting cycle, and a manual defrosting operation is only require in most extreme cases. It is better to avoid if not necessary.
-  While in the 'defrost' mode, the fridge cooling power is reduced, as the compressor is not working. The automatic cycles ensure the defrosting is done in the most efficient manner, and when required. It is not recommended to leave the fridge in the manually set defrost mode for prolonged periods of time.



NOTE: the controller allows you to choose a desired operating temperature of between -2°C and 8°C.

BeefEater do not recommend to operate the fridge on settings of below 4°C, as such settings will cause content of the fridge to freeze, and will result in unnecessary strain on the cooling systems, and undue high energy consumption.



Note: it is advisable to keep the cover over the controller closed when not being accessed, so no unintended operation or damage will occur.



Note: in normal operation the controller turns the compressor off at the set temperature, and back on after the temperature had risen by a few degrees. As such, the reading in the controller is always a couple of degrees above set-point, and that is perfectly OK.

When temperature was reached and the compressor is in its 'off' cycle, no indicator light will illuminate in the controller:

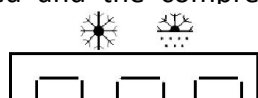

- Internal Fridge Light

The light inside the fridge can be turned On and Off using the light switch found on the right-hand side internal wall of the fridge:

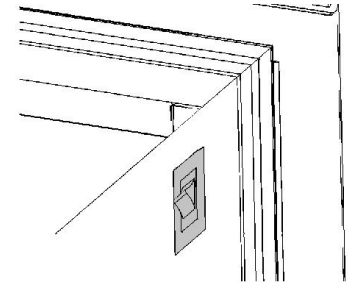

Replacing Lamps

Your BeefEater Fridge is using long-life, energy-saving LED light tube. Should you need to replace this light, please contact your nearest BeefEater stockiest or service agent for a suitable replacement part.

To change the light tube:

1. Unplug the power plug and ensure the light switch is off.
2. Remove the screws on both end of the light cover.
3. Take off the lamp cover, pull out the wires slightly.
4. Gently pull out the connector at the end of the light tube.
5. Insert the connector into the new lamp, place the lamp cover and fasten it.

Technical Information

REFRIGERATOR			
Model	BF1130	BF2200	BF3310
Climate Class	5M2	5M2	5M2
Storage Volume	118L	190L	307L
Protection Class	I	I	I
Voltage	220-240v, 50Hz	220-240v, 50Hz	220-240v, 50Hz
Input Power	182w	213w	408w
Light bulb power	3.3w	2.5w	4.5w
Input Current	0.95A	1.2A	2.1A
IP Rating	IPX4	IPX4	IPX4
Refrigerant	R600a/55g	R600a/68g	R600a/90g
Dimensions	840x555x520mm	840x855x520mm	840x1350x520mm
Foaming Agent	Cyclopentane	Cyclopentane	Cyclopentane



Note: your BeefEater Fridge is built to eliminate any fog accumulating on the glass doors, so vision through the doors is never obstructed. This is achieved by heating the outer surface of the door slightly, and as such it is normal for the door to feel slightly warm for the touch.

Woodland Home Products
 3-5 Birmingham Av, Chester Hill, NSW,
 Australia, 2162
 Phone: 1800 356 660
 Facsimile: 02 9724 8899
 E-mail: mail@beefeaterbbq.com
 Website: www.beefeaterbbq.com
 USA TollFree: 1866 550 2333

Images in this manual are for illustrative purposes only. Due to constant improvement, BeefEater advises that changes to the design, material, specifications and product configuration may occur at any time without notice.



Serious Barbecues

Warranty

Our goods come with guarantees that cannot be excluded under the Australian Consumer Law. You are entitled to a replacement or refund for a major failure and for compensation for any other reasonably foreseeable loss or damage. You are also entitled to have the goods repaired or replaced if the goods fail to be of acceptable quality and the failure does not amount to a major failure. Should any part fail due to defective workmanship or faulty materials within the specified period from the date of purchase, BeefEater or its distributor will repair or, (at distributors option), replace the defective part free of charge.

Warranty Administration

In Australia, warranty is administered by Woodland Home Products.

To ensure speedy processing of your warranty service claim, ensure that you record all specific details about your BeefEater Fridge. Keep this information handy for future reference, and a copy of your purchase receipt.

Not Covered

Storage

BeefEater fridge must not be exposed to the elements. It must never be positioned in direct sunlight, or subjected to any moisture ingress.

This warranty does not cover the purchaser or any other person for damage, malfunction or loss due to the following:

- Lack of maintenance, abuse, neglect, misuse, accident or improper installation of this Fridge.
- Scratches, dents, corrosion or discoloring caused by heat, abrasive or chemical cleaners or chipping of porcelain or painted parts.
- Corrosion or damage caused by exposure to the elements, grease fires, insects, weather or hail.
- Cleaning and normal wear and tear. Service calls of this nature are chargeable.
- Rusting of steel parts and accessories.
- Commercial use of the Fridge.
- Unauthorized repairs during the warranty period
- Removal or re-installation costs.
- Cracks and weathering of any parts caused by exposure to the elements or damage by weather, heat, insects, chemicals or foods acids or juices.

Note: Fridge must be protected and under cover at all times.

Note: Any staining to the outer surfaces should be removed by a gentle scrub pad and the surface cleaned with suitable cleaning materials.

Conditions of Warranty

1. The BeefEater Fridge is delivered to the BeefEater distributor's service department or authorized service agent and freight charges both ways are paid by the owner. No liability is accepted for loss or damage during transit.
2. The Barbecue is operated and maintained in accordance with the instructions supplied.
3. Repairs or service must be carried out by an authorized person. Installation must be in line with instructions as set out in this book.
4. No alterations or repairs have been carried out without obtaining the distributors prior consent. Such repair or any replacement does not extend the warranty period.
5. Proof of purchase together with this warranty card must be provided to verify purchase date and establish the warranty period. Only the original purchaser is covered under this warranty.
6. The warranty period is calculated from the date of purchase only.
7. Where this warranty is inconsistent with any state laws, the statutory rights of the purchaser shall prevail.
8. Parts installed from other manufacturers' products will void this warranty.

Warranty Term

All parts and workmanship of this BeefEater Fridge are covered for a period of 1 year from date of purchase.