



DISHWASHERS

SAFETY INFORMATION4

USING THE DISHWASHER

Getting Started.....8

Dispensers.....13

Loading15

CARE AND CLEANING17

TROUBLESHOOTING TIPS.....18

LIMITED WARRANTY22

ACCESSORIES23

CONSUMER SUPPORT 24

OWNER'S MANUAL

Standard Tub Dishwashers

ENGLISH/FRANÇAIS

Write the model and serial numbers here:

Model # _____

Serial # _____

You can find them on a label on the tub wall just inside the door.



THANK YOU FOR MAKING GE APPLIANCES A PART OF YOUR HOME.

Whether you grew up with GE Appliances, or this is your first, we're happy to have you in the family.

We take pride in the craftsmanship, innovation and design that goes into every GE Appliances product, and we think you will too. Among other things, registration of your appliance ensures that we can deliver important product information and warranty details when you need them.

Register your GE appliance now online. Helpful websites and phone numbers are available in the Consumer Support section of this Owner's Manual. You may also mail in the pre-printed registration card included in the packing material.





IMPORTANT SAFETY INFORMATION

READ ALL INSTRUCTIONS BEFORE USING THE APPLIANCE

⚠ WARNING For your safety, the information in this manual must be followed to minimize the risk of fire, explosion, electric shock, and to prevent property damage, personal injury, or death.

⚠ WARNING PROPER INSTALLATION AND MAINTENANCE

This dishwasher must be properly installed and located in accordance with the Installation Instructions before it is used. If you did not receive an Installation Instructions sheet with your dishwasher, you can receive one by visiting our Website at GEAppliances.com. In Canada, visit www.GEAppliances.ca.

- Connect the dishwasher/appliance to a grounded metal, permanent wiring system; or run an equipment-grounding conductor with the circuit conductors and connect to the equipment-grounding terminal or lead of the appliance.
- Improper connection of the equipment-grounding conductor can result in a risk of electric shock. Check with a qualified electrician or service representative if you are in doubt whether the appliance is properly grounded.
- Detailed grounding instructions can be found in the "PREPARE ELECTRICAL WIRING" section of the Installation Instructions.
- Dispose of discarded appliances and shipping or packing material properly.
- Do not attempt to repair or replace any part of your dishwasher unless it is specifically recommended in this manual. All other servicing should be referred to a qualified technician.
- Use only cord kit WX09X70910 or hard-wire to building electrical. Failure to follow this instruction, could result in risk of fire and personal injury.
- To minimize the possibility of electric shock, disconnect this appliance from the power supply before attempting any maintenance.

NOTE: Turning the dishwasher off does not disconnect the appliance from the power supply. We recommend having a qualified technician service your appliance.

⚠ WARNING WHEN USING YOUR DISHWASHER, FOLLOW BASIC PRECAUTIONS, INCLUDING THE FOLLOWING:

- Use this appliance only for its intended purpose as described in this Owner's Manual.
- Use only detergents or wetting agents recommended for use in a dishwasher and keep them out of reach of children. Using a detergent that is not specifically designed for dishwashers will cause the dishwasher to fill with suds.
- Locate sharp items so that they are not likely to damage the door seal.
- Load sharp knives with the handles up to reduce the risk of cut-type injuries.
- Do not wash plastic items unless marked dishwasher safe or the equivalent. For plastic items not so marked, check the manufacturer's recommendations.
- Do not touch the heating element during or immediately after use.
- Do not operate your dishwasher unless all enclosure panels are properly in place.
- Do not tamper with controls.
- Do not abuse, sit on or stand on the door or dish rack of the dishwasher.
- To reduce the risk of injury, do not allow children to play with, on or inside this appliance at any time.
- Do not store or use combustible materials including gasoline or other flammable liquids or vapors in the vicinity of this or any other appliance.
- Small parts, such as rack clips, can be a choke hazard to small children if removed from the dishwasher. Keep out of reach of small children.

READ AND SAVE THESE INSTRUCTIONS

IMPORTANT SAFETY INFORMATION

READ ALL INSTRUCTIONS BEFORE USING THE APPLIANCE

⚠️ WARNING WATER HEATER SAFETY

Under certain conditions, hydrogen gas may be produced in a water heater that has not been used for two or more weeks. **HYDROGEN GAS IS EXPLOSIVE.**

If the hot water has not been used for two or more weeks, prevent the possibility of damage or injury by turning on all hot water faucets and allowing them to run for several minutes. Do this before using any electrical appliance connected to the hot water system. This simple procedure will allow any built-up hydrogen gas to escape. Since the gas is flammable, do not smoke, use an open flame, or use the appliance during this process.

⚠️ WARNING RISK OF CHILD ENTRAPMENT

PROPER DISPOSAL OF THE DISHWASHER

Junked or abandoned dishwashers are dangerous...even if they will sit for “just a few days.” If you are getting rid of your dishwasher, please follow the instructions below to help prevent accidents.

- Do not allow children to play with, on, or inside this or any discarded appliance.
- Take off the door of the washing compartment.

⚠️ CAUTION TO PREVENT MINOR INJURY AND PROPERTY DAMAGE

- During or after wash cycle, contents may be hot to the touch. Use care before handling.
- Close supervision is necessary if this appliance is used by or near children. Do not allow children to play around the dishwasher when closing the door, closing the upper rack, or while vertically adjusting the upper rack due to the possibility of small fingers being pinched.
- Non-Dishware Items: Do not wash items such as electronic air cleaner filters, furnace filters and paint brushes in your dishwasher. Damage to the dishwasher and discoloration or staining of the dishwasher may result.
- Load light-weight, plastic items so they do not become dislodged and drop to the bottom of the dishwasher—they might come into contact with the heating element and be damaged.

ELECTRICAL REQUIREMENTS

Be sure that the electrical connection and wire size are adequate and in conformance with the National Electric Code, ANSI/NFPA 70 – latest edition, and all local codes and ordinances.

This appliance must have:

- 120V, 60Hz, AC-only, 15-ampere or 20-ampere, fused electrical supply.
- Wiring must be 2 wire with ground and rated for 75°C (167°F).

- If the electrical supply does not meet the above requirements, call a licensed electrician before proceeding.

It is recommended to have:

- A circuit breaker or time-delay fuse.
- A properly grounded individual branch circuit.

⚠️ NOTICE

- If your dishwasher is connected to a wall switch, ensure that the switch is on prior to use.
- If you choose to turn the wall switch off between wash cycles, allow 5-10 seconds after turning the switch on before touching **Start** to allow the control to initialize.
- Use only powder, **Cascade® Platinum™ ActionPacs™** or **Finish® Quantum® Automatic Dishwashing Detergent**, liquid detergents or rinse agents recommended for use in a dishwasher and keep them out of the reach of children. **Cascade® Platinum™ ActionPacs™** or **Finish® Quantum® Automatic Dishwashing Detergent**, and **Cascade® Platinum™ Power Dry™ Rinse Aid** or **Finish® Jet-Dry® Rinse Aid** rinse agents have been approved for use in all GE Appliances dishwashers.

READ AND SAVE THESE INSTRUCTIONS

INFORMACIÓN IMPORTANTE DE SEGURIDAD LEA TODAS LAS INSTRUCCIONES ANTES DE USAR

▲ADVERTENCIA Para su seguridad, siga las instrucciones de este manual a fin de minimizar riesgos de incendio, explosión, descargas eléctricas, y para evitar daños en su propiedad, lesiones personales o la muerte.

▲ADVERTENCIA INSTALACIÓN Y MANTENIMIENTO ADECUADOS

Esta lavadora se deberá instalar y ubicar de acuerdo con las Instrucciones de Instalación antes de ser usada. Si no recibió una ficha de Instrucciones de Instalación con su lavavajillas, podrá acceder a una visitando nuestro sitio web en **GEAppliances.com**.

- Conecte el lavavajillas/ electrodoméstico a un sistema de cableado de metal permanente con conexión a tierra o se debe tender un conducto para la conexión a tierra del equipo con los conductores del circuito y conectado al terminal de tierra del equipo o al conductor de suministro del electrodoméstico.
 - Una conexión inapropiada del conductor de conexión a tierra del equipo puede provocar riesgos de descargas eléctricas. Consulte a un electricista calificado o personal del servicio técnico si tiene dudas de que el electrodoméstico se encuentre conectado a tierra apropiadamente.
 - Las instrucciones detalladas de conexión a tierra se pueden encontrar en la sección "PREPARACIÓN DEL CABLEADO ELÉCTRICO" de las Instrucciones de instalación.
 - Deshágase de forma correcta de electrodomésticos y materiales de envío o embalajes descargados.
 - No intente reparar o reemplazar ninguna parte de la cocina, a menos que se lo recomiende específicamente en este manual. Cualquier otra reparación deberá ser realizada por un técnico calificado.
 - Use sólo el kit de cables WX09X70910 o cables duros para la conexión eléctrica. Si no se siguen estas instrucciones, se pueden producir riesgos de incendio y lesiones personales.
 - A fin de minimizar la posibilidad de descargas eléctricas, desconecte este electrodoméstico del suministro de corriente antes de intentar cualquier mantenimiento.
- NOTA:** Apagar el lavavajillas no desconecta el electrodoméstico del suministro de corriente. Le recomendamos que el servicio técnico de su electrodoméstico sea realizado por un técnico calificado.

▲ADVERTENCIA AL USAR SU LAVAVAJILLAS, SIGA LAS PRECAUCIONES BÁSICAS, INCLUYENDO LO SIGUIENTE:

- Use este electrodoméstico sólo para su propósito original, como se describe en el Manual del Propietario.
- Use sólo detergentes o agentes humectantes recomendados para use con un lavavajillas y mantenga los mismos fuera del alcance de los niños. El uso de un detergente que no esté diseñado específicamente para lavavajillas hará que este último se llene de agua con jabón.
- Ubique artículos puntiagudos de modo que no haya posibilidades de daños sobre el sellador de la puertal.
- Cargue los cuchillos puntiagudos con los mangos hacia arriba, a fin de reducir el riesgo de lesiones por cortes.
- No lave productos de plástico, a menos que contengan una marca de seguridad en lavavajillas o su equivalente. Cuando se trate de productos de plástico que no estén marcados de esta manera, consulte las recomendaciones del fabricante.
- No toque el elemento de calefacción durante o inmediatamente después del uso.
- No use su lavavajillas a menos que todos los paneles de cercamiento estén correctamente en sus lugares.
- No manipule indebidamente los controles.
- No abuse, no se siente, no se sostenga ni se pare sobre la puerta o la bandeja del plato del lavavajillas.
- A fin de reducir el riesgo de incendios, no permita que los niños jueguen con, sobre o dentro de este electrodoméstico en cualquier momento.
- No guarde ni use materiales combustibles, incluyendo gasolina u otros líquidos o vapores inflamables cerca de éste o de otros electrodomésticos.
- Las piezas pequeñas, tales como los sujetadores de estantes, pueden generar riesgos de asfixia en niños pequeños si son retirados del lavavajillas. Mantenga los mismos fuera del alcance de los niños pequeños.

LEA Y GUARDE ESTAS INSTRUCCIONES

INFORMACIÓN IMPORTANTE DE SEGURIDAD

LEA TODAS LAS INSTRUCCIONES ANTES DE USAR

▲ ADVERTENCIA SEGURIDAD DEL CALENTADOR DE AGUA

Bajo ciertas condiciones, se podrá producir gas de hidrógeno en un calentador de agua que no fue usado por dos semanas o más. **EL GAS DE HIDRÓGENO ES UN EXPLOSIVO.**

Si el agua caliente no se usó durante dos semanas o más, evite la posibilidad de daño o lesión abriendo todos los grifos de agua caliente y permitiendo que el agua corra durante varios minutos. Haga esto antes de usar cualquier artefacto eléctrico que esté conectado al sistema de agua caliente. Este procedimiento simple permitirá el escape de cualquier gas de hidrógeno acumulado. Debido a que el gas es inflamable, no fume, no use una llama abierta ni use el electrodoméstico durante este proceso.

▲ ADVERTENCIA RIESGO DE QUE UN NIÑO QUEDE ATRAPADO

FORMA ADECUADA DE DESCARTAR EL LAVAVAJILLAS

Los lavavajillas tirados o abandonados son peligrosos...incluso aunque se conserven por "sólo unos pocos días". Si se deshará de su lavavajilla, siga las siguientes instrucciones a fin de evitar accidentes.

- No permita que los niños jueguen con, en, o dentro de éste o cualquier electrodoméstico que haya descartado.
- Retire la puerta del compartimiento de lavado.

▲ PRECAUCIÓN A FIN DE EVITAR LESIONES MENORES Y DAÑOS SOBRE LA PROPIEDAD

- Durante o después del ciclo de lavado, es posible que los contenidos estén calientes al tacto. Tenga cuidado antes de tomar los mismos.
- Se deberá estar especialmente atento si el electrodoméstico es usado por niños o se encuentra cerca de los mismos. No permita que los niños jueguen alrededor del lavavajillas cerrar la puerta, cerrar la bandeja superior, o mientras verticalmente ajustando la rejilla superior debido a la posibilidad de que sus dedos pequeños sean presionados.
- Productos que no sean utensilios: no lave artículos tales como filtros electrónicos de limpieza con aire, filtros de horno y brochas de pintura en su lavavajillas. Se podrán producir daños, descoloración o manchas sobre el lavavajillas.
- Cargue artículos de plástico livianos, de modo que no sean desplazados ni caigan al fondo del lavavajillas – es posible que entren en contacto con el calentador y sean dañados.

REQUISITOS ELÉCTRICOS

Asegúrese de que la conexión eléctrica y el tamaño del cable sean los adecuados y que cumplan con el Código Nacional de Electricidad, ANSI/NFPA 70 – última edición, y con todos los códigos y ordenanzas locales.

Este electrodoméstico deberá contar con:

- 120V, 60Hz, CA - únicamente, 15 amperes o 20 amperes, suministro eléctrico con fusible.
- El cableado deberá constar de 2 cables con tierra y resistente a 75°F (167°F).

- Si el suministro eléctrico provisto no cumple con los requisitos anteriores, llame a un electricista matriculado antes de proceder.

Se recomienda contar con:

- Un disyuntor y un fusible de retardo.
- Un circuito de empalmes individual correctamente conectado a tierra.

▲ AVISO

- Si el lavavajillas está conectado a un tomacorriente de pared, asegúrese de que el interruptor esté encendido antes del uso.
- Si decide apagar el interruptor entre ciclos de lavado, espere entre 5 y 10 segundos luego de encender el interruptor antes de presionar **Start** (Iniciar) para permitir que el control se inicie.
- Use sólo polvo, **Cascade® Platinum™ ActionPacs™** o **Finish® Quantum® Automatic Dishwashing Detergent**, detergentes líquidos o agentes de enjuague recomendados para uso con un lavavajillas y mantenga los mismos fuera del alcance de los niños. El Detergente para Lavavajillas Automáticos **Cascade® Platinum™ ActionPacs™** o **Finish® Quantum® Automatic Dishwashing Detergent**, y los agentes de enjuagues **Cascade® Platinum™ Power Dry™ Rinse Aid** o **Finish® Jet-Dry® Rinse Aid** fueron aprobados para su uso en todos los lavavajillas de GE Appliances.

LEA Y GUARDE ESTAS INSTRUCCIONES

Getting started

Features and appearance will vary throughout this manual

Match the control panel for your unit to a similar control panel below.

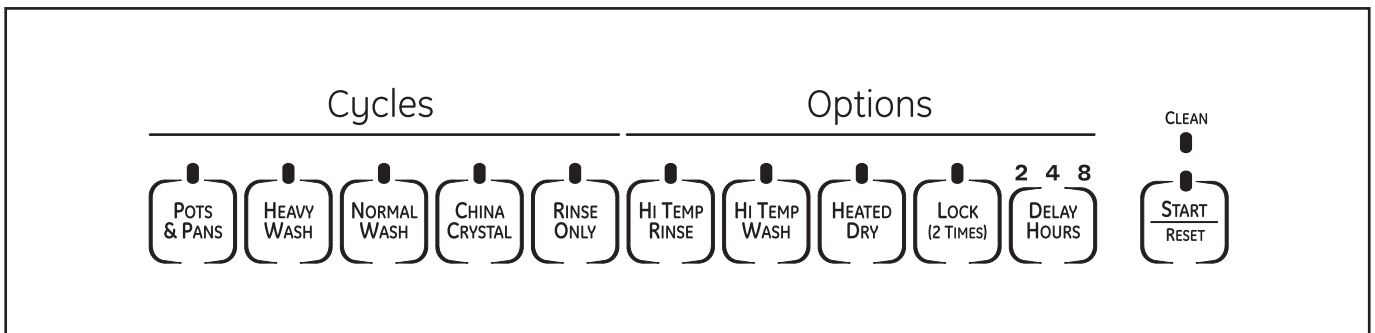
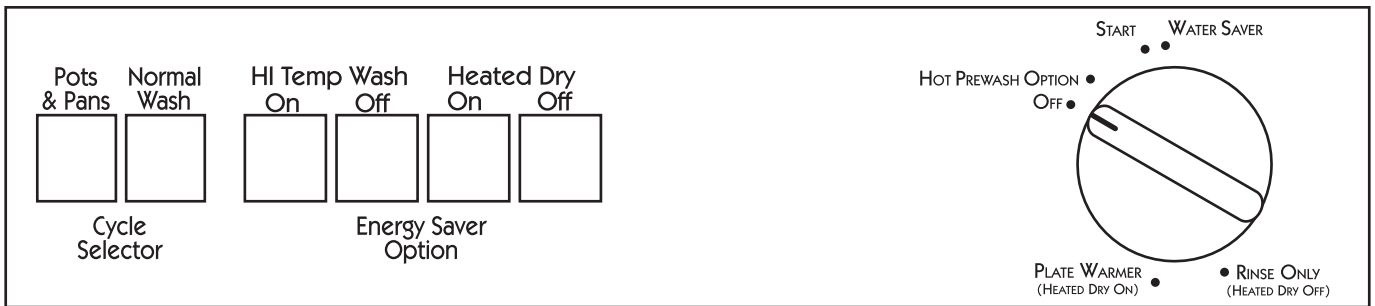
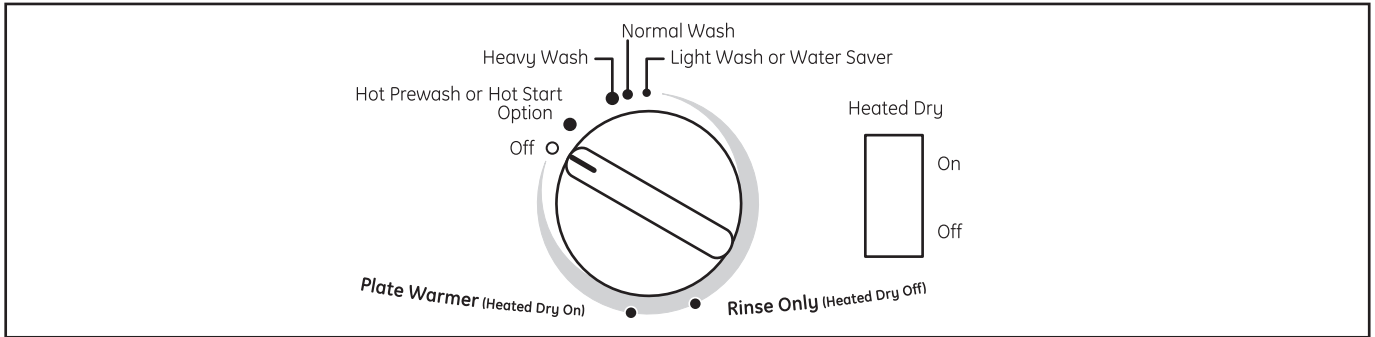

1 Load Dishwasher
 For best dishwashing results, follow the loading guidelines found in the **Loading** section. No pre-rinsing of normal food soil is required. Scrape off hard soils, including bones, toothpicks, skins, and seeds. Remove leafy vegetables, meat trimmings, and excessive amounts of grease or oil.

2 Add Detergent
 Add needed amount of detergent to the detergent dispenser. Use high quality detergents such as **Cascade® Platinum™ ActionPacs™** or **Finish® Quantum® Automatic Dishwashing Detergent**. See **Dispensers** section.

3 Add Rinse Agent
 Add high quality rinse agents such as **Cascade® Platinum™ Power Dry™ Rinse Aid** or **Finish® Jet-Dry® Rinse Aid** to the rinse agent dispenser. See **Dispensers** section. **NOTE:** The use of rinse aid can further enhance the dishwasher's drying performance.

Getting started

4 Select Cycle

On some models, an indicator light above the selected pad will be on to indicate which CYCLE has been selected.

NOTE: Actual cycle times vary based on soil level, water temperature, and options selected.

POTS & PANS/ HEAVY WASH (on some models)	For heavily soiled dishes or cookware with dried-on or baked-on soils. Everyday dishes may be included. This cycle will not remove burned-on foods.
NORMAL/ NORMAL WASH	This cycle is meant for daily, regular, or typical use to completely wash a full load of normally soiled dishes and is designed to conserve both water and energy.
SHORT WASH (on some models)	For quickly washing loads of everyday dishes with medium soils that have not dried on, such as loads consisting mostly of glasses.
WATER SAVER/ LIGHT WASH (on some models)	For dishes with light soils.
RINSE ONLY	For rinsing partial loads that will be washed later. Do not use detergent.
DRYING/ PLATE WARMER (on some models)	For warming clean dishes and serving plates. This cycle will take approximately 30 minutes.
HOT PREWASH/ HOT START (on some models)	Preheats wash water to the correct temperature.
CHINA CRYSTAL (on some models)	For lightly soiled china and crystal.

Cycle Chart

Models	Cycle	Water Usage (gallons)	Cycle Time (minimum)
Timer Models	Hot Start Option ¹	2.5	10
	Heavy Wash	4.9 - 7.0	120
	Pots & Pans	6.0 - 7.0	118
	Normal Wash*	3.5 - 5.0	106
	Light Wash/Water Saver	3.9 - 5.5	114
	Rinse Only	2.2	58
	Plate Warmer/Drying	0.0	45
Electronic Models	Pots & Pans	8.8	121
	Heavy Wash	7.5	115
	Normal Wash	3.5	109
	China/Crystal	6.3	87
	Rinse Only	1.3	5

¹Hot Start Option adds water amount and cycle time shown when selected.

*Normal Wash button should be pushed to run this cycle.

NOTE: Not all models have every cycle listed.

Getting started

5 Select Options

On some models, an indicator light above the selected pad will be on to indicate which CYCLE has been selected.

NOTE: Actual cycle times vary based on soil level, water temperature, and options selected.

HI TEMP RINSE (on some models) Turns on the heater in all final rinse cycles to help prevent spotting on dishware. This option may be turned **ON** or **OFF** during the wash cycle.

HI TEMP WASH Energizes the heater to boost water temperature in prewash and main wash fill cycles. Recommended for use with heavily soiled dishes. Option may be turned **ON** or **OFF** during the wash cycle.

HEATED DRY OFF Shuts off the drying heat option. Dishes air dry naturally and energy is saved. Open the dishwasher door to speed drying.

HEATED DRY ON Turns the heater on for fast drying. This cycle will extend the time to your wash cycle by 30 minutes. DO NOT use with **RINSE ONLY** cycle.

LOCK (electronic models only) When the **LOCK** pad is touched twice within 3 seconds, all pads become inoperative. You can lock the controls to prevent any selections from being made. Or you can lock the controls after you have started a cycle or selected **DELAY START** so the cycle or **DELAY START** is not interrupted.

Children cannot accidentally start dishwasher by touching pads with this option selected.

To unlock the dishwasher after it has been locked, touch the **LOCK** pad twice within 3 seconds. The light above the **LOCK** pad will turn off.

DELAY HOURS (on some models) Delays the start of a wash cycle for up to 8 hours.

RESET (timer models only) Touch **RESET** to cancel options.

START/RESET (electronic models only) Touch **START/RESET** one time to start dishwasher cycle. Touch **START/RESET** a second time to pump out and then turn off the dishwasher. Do not touch **START/RESET** more than one time unless you intend to end the cycle.

Starting the dishwasher - Models with a cycle dial

Rinse Only

For rinsing partial loads that will be washed later. **Do not use detergent.**

- 1 Make sure **HEATED DRY** is **not** selected.
- 2 Be sure the door is unlatched.
- 3 Slowly turn the dial to **RINSE ONLY**.
- 4 Latch the door to start the cycle.

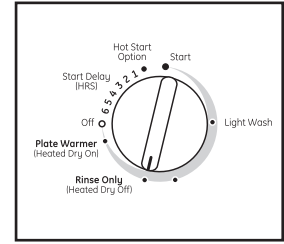
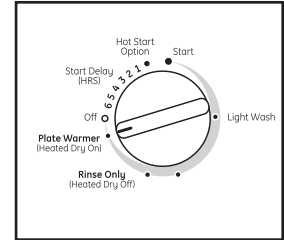

Plate Warmer or Drying

For warming clean dishes and serving plates. This cycle will take approximately 39 minutes.

- 1 Load clean dishware to be warmed.
- 2 Select **HEATED DRY ON**.
- 3 Be sure the door is unlatched.
- 4 Slowly turn the dial to **PLATE WARMER** or **DRYING**.
- 5 Latch the door to start the cycle.



Hot Start or Hot Prestart Option

Preheats wash water.

- 1 Select the **HOT START** or **HOT PRESTART** cycle and any other option on the push button pad.
- 2 Be sure the door is unlatched.
- 3 Slowly turn the dial to **HOT START** or **HOT PRESTART**.
- 4 Latch the door to start the cycle.

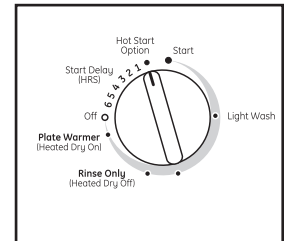

Short Wash or Light Wash or Water Saver

For quickly washing loads of everyday dishes with light to medium soils that have not dried on.

- 1 Be sure the door is unlatched.
- 2 Slowly turn the Dial to **SHORT WASH**, **LIGHT WASH** or **WATER SAVER**.
- 3 Latch the door to start the cycle.

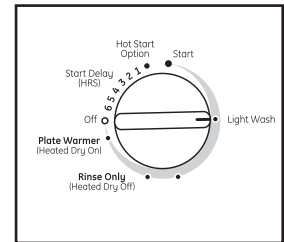

Start (Models with a Dial)

Slowly turn the dial to the **START** or **ON** position, or the selected cycle. Don't turn it past the **START**, **ON** or cycle position; you could accidentally miss a prewash.

There is a time delay between start-up and water fill so you will not hear any wash action right away.

- Latch the door to begin the cycle.

Starting the dishwasher - Model GSD4000 only

Start

- 1 The door must be closed and locked into place to select a **LOAD SELECTION** or an **OPTION**.
- 2 If the door is opened during a cycle and left open, the dishwasher will beep once every 30 seconds until the door is closed and latched into place.

Close and latch the door. Touch the **START/RESET** pad to begin the cycle. Water fill begins and approximately 60 seconds later the wash action begins.

NOTE: The dishwasher remembers your last cycle so you don't have to reprogram each time. When the dishwasher is loaded and the door latch is in the locked position, the control panel lights will be on and display the last settings you selected.



If you don't want to change any of the settings, simply touch the **START/RESET** pad to begin the cycle.

Also, if a power failure occurs, **NORMAL** and **HEATED DRY** will automatically be programmed. Make any new selections and touch the **START/RESET** pad to begin the cycle.

Clean

This light is illuminated when a wash cycle is complete. The light will stay ON until the door is opened.

Flashing Display Lights

Lights	What It Means	What to do
	This is normal. The START/RESET pad has been pressed.	Allow the dishwasher to drain and reset before you start a new wash cycle.
<p>CLEAN</p>  <p>Plus a beeping sound</p>	Control Error	Press the START/RESET pad to turn off the beeper. If the CLEAN light continues to flash, call for service.
 <p>Plus a beeping sound</p>	Control Error	Press the START/RESET pad to turn off the beeper and the dishwasher will attempt to reset. Restart the wash cycle. If this error continues, turn off the power to the dishwasher at the circuit breaker for 30 seconds. Try the dishwasher again. If the error is still present, call for service.

Dispensers

Check the Water Temperature

The entering water should be at least 120°F (49°C) and not more than 150°F (66°C) for effective cleaning and to prevent dish damage. Check the water temperature with a candy or meat thermometer.

Turn on the hot water faucet nearest the dishwasher, place the thermometer in a glass and let the water run continuously into the glass until the temperature stops rising.

Adjust the maximum/minimum temperature of the water heater if necessary to deliver water at the proper temperature.

Use a Rinse Agent

High quality rinse agents such as **Cascade® Platinum™ Power Dry™ Rinse Aid** or **Finish® Jet-Dry® Rinse Aid** are designed for great drying action and to protect against spots and film build-up on your dishes, glasses, flatware, cookware, and plastic.

Filling the Rinse Agent Dispenser

Fill the rinse agent dispenser until it reaches the bottom of lip inside the opening. Replace cap.

To check if rinse agent is needed, remove the cap and look into the dispenser.

A full dispenser should last about one month.

If the rinse agent spills, wipe up the excess.

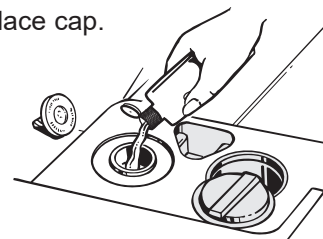

Dispensers

Detergent Dispenser

Use only high quality automatic dishwasher detergents to avoid sudsing. **Cascade® Platinum™ ActionPacs™** or **Finish® Quantum® Automatic Dishwashing Detergent** have been approved for use in all GE Appliances dishwashers. Keep your detergent fresh and dry. Don't put powder detergent into the dispenser until you're ready to wash dishes.

The amount of detergent to use depends on whether your water is **hard** or **soft**. With hard water, you need extra detergent. With soft water, you need less detergent.

Protect your dishes and dishwasher by contacting your water department and asking how hard your water is. Twelve or more grains is extremely hard water. A water softener is recommended. Without it, lime can build up in the water valve, which could stick while open and cause flooding.

You'll find two detergent dispensers on the inside door of your dishwasher. All wash cycles require detergent in the main cup. When using automatic dishwashing detergent tabs, such as **Finish® Quantum® Powerball®**, simply place one tab in the main cup and close.

Be sure the dial is **OFF** before adding detergent. Otherwise, the detergent cup will not close and latch properly. Add detergent then close the main cup.



NOTE: To open detergent cup after it has been closed, simply turn the detergent cup handle counterclockwise until it releases. A snapping sound may be heard.

Use the table as a starting point and then adjust the amount of detergent you use. Use just enough to get good wash performance. Using just the right amount of detergent will provide great wash performance without wasting detergent or etching glassware.

Number of Grains/Gal.	Detergent Cup(s) to Fill
Less than 4	Fill cup to 1/3 full
4 to 8	Fill cup to 2/3 full
8 to 12	Fill cup completely full
Greater than 12	Fill both main wash cup and open cup

Using too much detergent with very soft and/or very hot water may cause a condition called etching on your glassware. Etching is a permanent cloudiness in your glassware. This condition is irreversible. However, using too little detergent will cause poor wash performance.

DO NOT USE HAND DISH DETERGENT

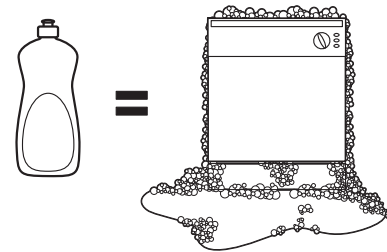

NOTE: Using a detergent that is not specifically designed for dishwashers will cause the dishwasher to fill with suds. During operation, these suds will spill out of the dishwasher vents, covering the kitchen floor and making the floor wet.

Because so many detergent containers look alike, store the dishwasher detergent in a separate space from all other cleaners. Show anyone who may use the dishwasher the correct detergent and where it is stored.

While there will be no lasting damage to the dishwasher, your dishes will not get clean using a dishwashing detergent that is not formulated for automatic dishwashers.

Loading

For best dishwashing results, follow these loading guidelines. Features and appearance of racks and silverware baskets may vary from your model.

Upper Rack

The upper rack is for glasses, cups and saucers. Cups and glasses fit best along the sides. This is also a secure place for dishwasher-safe plastics. The upper rack is good for all kinds of odd-shaped utensils. Saucepans, mixing bowls and other items should be placed face down.

Secure larger dishwasher-safe plastics over two fingers when possible.

Make sure small plastic items are secure so they can't fall onto the heating element.

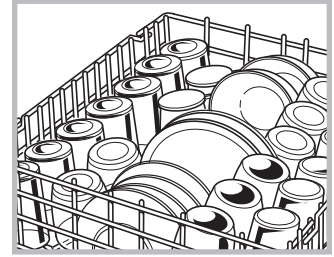

Lower Rack

The lower rack is best used for plates, saucers and cookware. Large items such as broiler pans and racks should go along the sides. Load platters, pots and bowls along the sides, in corners or in the back. The soiled side of items should face the center of the rack.

When loading the lower rack, do not load large platters or trays in the front right corner. They may prevent detergent from circulating during the wash cycle.

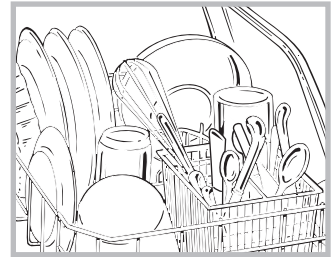

Wash Tower

Keep the center area clear in the lower rack.

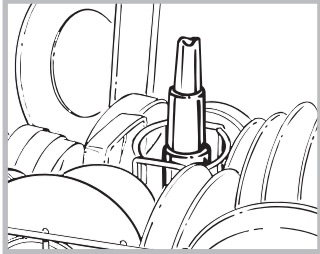

The wash tower rises through the center of the lower rack during the wash and rinse portions of the cycle.

Don't block the wash tower or load tall things next to it.

Be sure items don't fall through rack and block rotation of the spray arm.

Also, be careful not to let a portion of an item such as a pot or dish handle extend through the bottom rack. This could block the wash arm and cause poor washing results.



Don't block the upper rack wash tower.

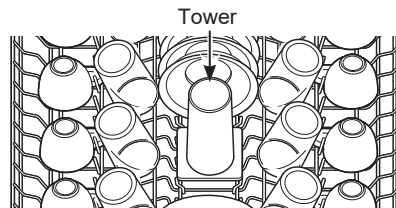

Do not cover upper rack tower (not present on all models)

Silverware Basket

Put flatware in the removable basket with fork and knife handles up to protect your hands. Place spoons in the basket with handles down. Mix knives, forks and spoons so they don't nest together. Distribute evenly. Small plastic items, such as measuring spoons and lids from small containers, should go in the bottom of the silverware basket with silverware on top

Don't let any item extend through bottom of silverware basket and rack, to ensure proper function of spray arm.



Loading

For best dishwashing results, follow these loading guidelines. Features and appearance of racks and silverware baskets may vary from your model.

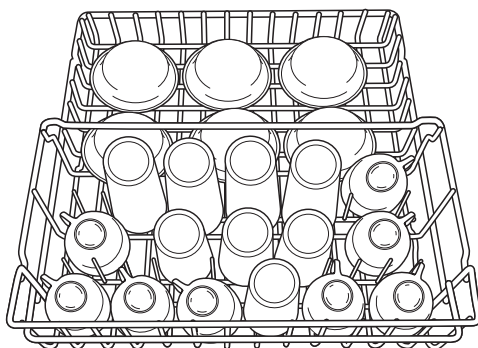

Upper Rack—8 place settings
Undersink Models

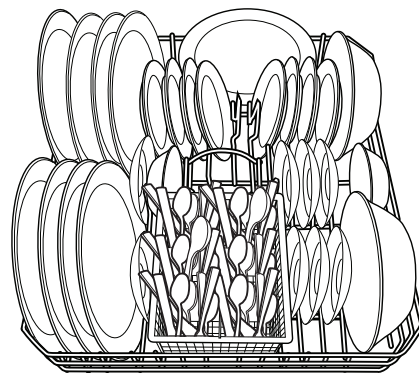

Lower Rack—8 place settings
Undersink Models

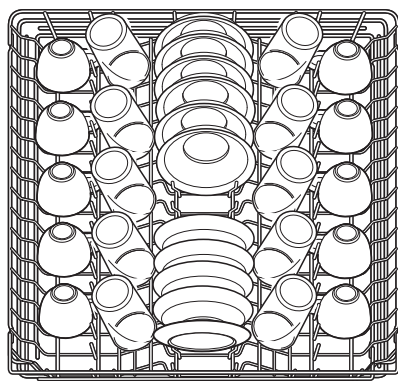

Upper Rack—10 place settings

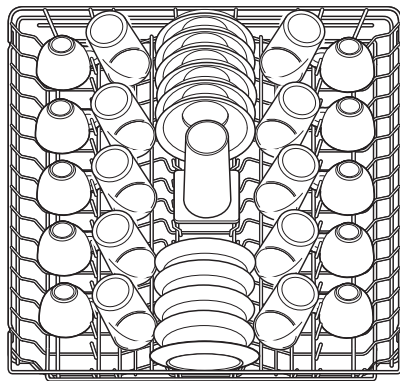

Upper Rack—10 place settings

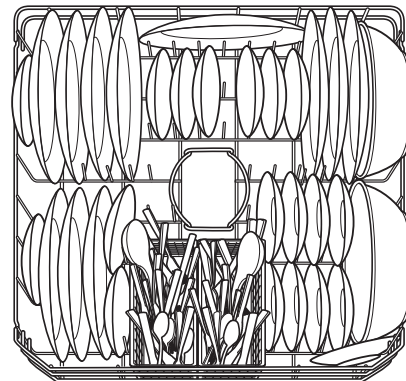

Lower Rack—10 place settings

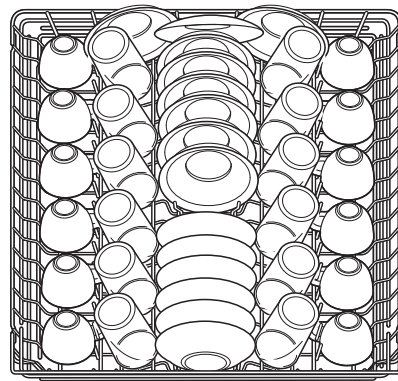

Upper Rack—12 place settings

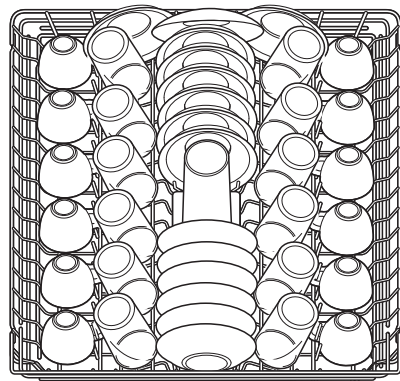

Upper Rack—12 place settings

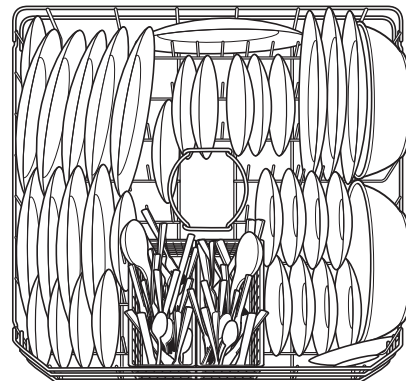

Lower Rack—12 place settings

Forget to Add a Dish?

A forgotten dish can be added any time before the main wash.

- 1 Push the door latch to the left.
- 2 Once the water calms, open the door. Steam may rise out of the dishwasher.
- 3 Add forgotten dish.
- 4 Close the door and push the latch to the far right.

Care and cleaning

Control Panel

To clean the control panel, use a lightly dampened cloth. Then dry thoroughly.

Exterior Door Panel

Use a clean, soft, lightly dampened cloth, then dry thoroughly.

Do not use scouring pads or powered cleaners because these products can scratch the finish.

Stainless Steel Door Panel

For cleaning rust and tarnish, cleaners with oxalic acid such as Bar Keepers Friend Soft Cleanser™ will remove rust, tarnish and small blemishes. Use only a liquid cleanser free of grit and rub in the direction of the brush lines with a damp soft sponge. Do not use appliance wax or polish on the stainless steel.

For other blemishes and marks, use Stainless Steel Magic or a similar product using a clean soft cloth. Do not use appliance wax, polish, bleach or products containing chlorine on Stainless Steel. You can order Stainless Steel Magic # WX10X29 through GE Appliances Parts by calling 877.959.8688. In Canada, call 1-800-661-1616.

Dishwasher Interior

To clean and de-odorize your dishwasher, use citric acid, or **Cascade® Platinum™ Dishwasher Cleaner** or **Finish® Dishwasher Cleaner**, a detergent additive. They will break up mineral deposits, and remove hard water film and stains.

You can order citric acid, GE Appliances kit # **WD35X151**, through GE Appliances Parts by calling 877-959-8688 or visiting **GEApplianceparts.com**. In Canada, call 800-661-1616. You can purchase dishwasher cleaners at your local grocery store.

Stainless Steel Inner Door and Tub

The stainless steel used to make the dishwasher tub and inner door provides the highest reliability available in a GE Appliances dishwasher.

If the dishwasher tub or inner door should be scratched or dented during normal use, they will not rust or corrode. These surface blemishes will not affect their function or durability.

Protect Against Freezing

If your dishwasher is left in an unheated place during the winter, ask a service technician to:

- 1 Turn off electrical power to the dishwasher. Remove fuses or trip circuit breaker.
- 2 Turn off the water supply and disconnect the water inlet line from the water valve.
- 3 Drain water from the water inlet line and water valve. (Use a pan to catch the water.)

- 4 Reconnect the water inlet line to the water valve.
- 5 Remove the plastic sump cover in the tub bottom and use a sponge to soak up water in the rubber boot.

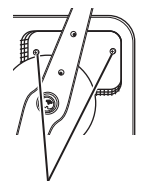

Sump cover screws

Does Your Dishwasher Have an Air Gap?

An air gap protects your dishwasher against water backing up into it if a drain clogs. The air gap is not a part of the dishwasher. It is not covered by your warranty. Not all plumbing codes require air gaps, so you may not have one.



Air gap
Check the air gap any time your dishwasher isn't draining well.

The air gap is easy to clean.

- 1 Turn off the dishwasher and lift off the air gap cover.
- 2 Remove the plastic cap under the cover and clean with a toothpick.
- 3 Replace the cap and cover when the air gap is clean.

Troubleshooting Tips... Before you call for service

Problem	Possible Cause	What To Do
Dishes and flatware not clean	Low inlet water temperature	Raise the water heater temperature to 120°F. Use HOT START , POTS & PANS or HEAVY WASH and HI TEMP WASH .
	Poor performing detergent	Use high quality detergents such as Cascade® Platinum™ ActionPacs™ or Finish® Quantum® Automatic Dishwashing Detergent .
	Old or damp powdered detergent	See USING THE DISHWASHER section, refer to Detergent Dispenser for detergent recommendations.
	Water pressure is temporarily low	Turn on a faucet. Is water coming out more slowly than usual? If so, wait until pressure is normal before using your dishwasher. Normal water pressure to the dishwasher should be 20-120 psi.
	Air gap or disposer clogged	Clean the air gap or flush the disposer.
	Improper rack loading	Make sure large dishware does not block the detergent dispenser or the wash arm. See the Loading section.
	High drain loop or air gap not installed	Refer to the Installation Instructions for proper drain line installation.
Spots and filming on glasses and flatware	Extremely hard water	Use high quality rinse agents such as Cascade® Platinum™ Power Dry™ Rinse Aid or Finish® Jet-Dry® Rinse Aid to prevent spots and prevent new film build-up. If water is extremely hard, a softener may be required.
	Low inlet water temperature	Make sure water temperature is at least 120°F (49°C).
	Overloading or improper loading of the dishwasher	Load dishwasher as shown in the Loading section.
	Old or damp powder detergent	Make sure detergent is fresh. Use high quality detergents such as Cascade® Platinum™ ActionPacs™ or Finish® Quantum® Automatic Dishwashing Detergent .
	Rinse agent dispenser empty	Refill with high quality rinse agents such as Cascade® Platinum™ Power Dry™ Rinse Aid or Finish® Jet-Dry® Rinse Aid .
	Too little or low performing detergent	Make sure you use the proper amount of highly rated detergent.
Cloudiness on glassware	Combination of soft water and too much detergent	This is called etching and is permanent. To prevent this from happening, use less detergent if you have soft water. Wash glassware in the shortest cycle that will get it clean.
	Low performing phosphate-free detergent	See A white film on glassware, dishware and the interior in this TROUBLESHOOTING section.
	Water temperature entering dishwasher exceeds 150°F	This could be etching. Lower the water heater temperature.

Troubleshooting Tips... Before you call for service

Problem	Possible Cause	What To Do
A white film on glassware, dishware and the interior	This problem is likely caused by a low quality phosphate-free dishwasher detergent	<p>To remove the white film, run your dishes through a dishwasher cycle with citric acid. Use a WD35X151 citric acid kit found online. Otherwise, use high quality rinse agents such as Cascade® Platinum™ Dishwasher Cleaner or Finish® Dishwasher Cleaner found at your local grocery store.</p> <p>Pour the citric acid in the detergent cup and close the cover. Place the filmed but otherwise clean glassware and dishware in the dishwasher. Leave silverware and other metal items out of the dishwasher. Turn the dishwasher on and let it run through a complete cycle without detergent. The glassware, dishware, and dishwasher should come out film free. Alternatively, a vinegar rinse may be used. Pour 1 cup of vinegar into dishwasher just after the detergent cup opens and let the dishwasher complete its cycle.</p> <p>This may be repeated several times a year as needed.</p> <p>The use of high quality rinse agents such as Cascade® Platinum™ Power Dry™ Rinse Aid or Finish® Jet-Dry® Rinse Aid may help minimize a repeat build up of film. Also, the use of high quality detergents such as Cascade® Platinum™ ActionPacs™ or Finish® Quantum® Automatic Dishwashing Detergent will help prevent film build-up.</p>
Suds in the tub	Wrong detergent	<p>Use only high quality automatic dishwasher detergents to avoid sudsing. Cascade® Platinum™ ActionPacs™ or Finish® Quantum® Automatic Dishwashing Detergent have been approved for use in all GE Appliances dishwashers.</p> <p>To remove suds from the tub, open the dishwasher and let suds dissipate. Add 1 gallon of cold water to the tub.</p> <p>On Models with a dial: Close and latch the dishwasher. Pump out water by slowly turning the dial until a drain period is reached. Repeat if necessary.</p> <p>On Models with Electronic Control: Pump out water by pressing the START/RESET pad, then 10 seconds later, press START/RESET pad again. Repeat if necessary.</p>
	Rinse agent was spilled	Always wipe up rinse agent spills immediately.
Detergent cup lid won't latch	Dial is not in the OFF position	Turn the timer dial to OFF .
Detergent left in dispenser cups	Dishes or utensils are blocking the detergent cup	Reposition the dishes. See the Loading section.



Troubleshooting Tips... Before you call for service

Problem	Possible Cause	What To Do
Black or gray marks on dishes	Aluminum utensils have rubbed against dishes	Remove marks with a mild, abrasive cleaner.
Dishes don't dry	Low inlet water temperature	Make sure inlet water temperature is at least 120°F. Select HEATED DRY . Use HOT START and ADDED HEAT options. Select a higher cycle, such as POTS & PANS or HEAVY WASH .
	Rinse agent dispenser is empty	Check the rinse agent dispenser and fill as required.
Control panel responded to inputs but dishwasher never filled with water	Door latch may not be properly seated	Call for service.
	Water valve may be turned off	Make sure water valve (usually located under the sink) is turned on.
Stained tub interior	Some tomato-based foods can cause reddish stains	Use of the RINSE ONLY cycle after adding the dish to the load can decrease the level of staining.
	Tea or coffee stains	Remove the stain by hand, using a solution of 1/2 cup bleach and 3 cups warm water. ⚠ CAUTION Before cleaning interior, wait at least 20 minutes after a cycle for the heating elements to cool down. Failure to do so can result in burns. ⚠ PRECAUCIÓN Antes de limpiar la parte interna, espere por lo menos 20 minutos luego de un ciclo, hasta que los elementos de calentamiento se enfríen. Si esto no se cumple, se podrán sufrir quemaduras.
	An overall yellow or brown film can be caused by iron deposits in water	A special filter in the water supply line is the only way to correct this problem. Contact a water softener company.
	White film on inside surface— hard water minerals	GE Appliances recommends high quality rinse agents such as Cascade® Platinum™ Power Dry™ Rinse Aid or Finish® Jet-Dry® Rinse Aid to help prevent hard water mineral deposits from forming. Run dishwasher with citric acid to remove mineral deposits. Citric acid (Part number: WD35X151) can be ordered through GE Appliances Parts. See back cover for ordering information. Alternatively, purchase Cascade® Platinum™ Dishwasher Cleaner or Finish® Dishwasher Cleaner and follow the directions on the label.
Dishwasher won't run	Fuse is blown or circuit breaker is tripped	Replace fuse or reset circuit breaker. Remove any other appliances from the circuit.
	Power is turned off	In some installations, the power to the dishwasher is provided through a wall switch, often located next to the disposer switch. Make sure it is on.

Troubleshooting Tips... Before you call for service

Problem	Possible Cause	What To Do
Control panel lights go off when you're setting controls	Time too long between touching of selected pads	Each pad must be touched within 30 seconds of the others. To relight, touch any pad again or unlatch and relatch the door.
Water standing in the bottom of the tub	This is normal	A small amount of clean water around the outlet on the tub bottom at the back of the tub keeps the water seal lubricated.
Water won't pump out of the tub	Drain is clogged	If you have an air gap, clean it. See the Care and Cleaning section. If the dishwasher drains into a disposer, run disposer clear. Check to see if your kitchen sink is draining well. If not, you may need a plumber.
Steam	This is normal	Warm, moist air comes through the vent during drying and when water is being pumped out. This is necessary for drying.
Sanitized light does not illuminate at the end of the cycle	The door was opened and the cycle was interrupted during final rinse	Do not interrupt the cycle by opening the door during the wash cycle.
	The incoming water temperature was too low	Raise the water heater temperature to between 120°F and 150°F.
Noise	Normal operating sounds: Hard food disposer shredding action. Drain valve opening to pump water out. Timer control as cycle progresses. Detergent cup opening. The motor stopping during the drying period. Water draining out of tub immediately after touching the start/reset pad.	These are all normal. No action is required.
	Utensils are not secure in rack or something small has dropped into rack	Make sure everything is secured in dishwasher.
	Rattling dishes when the spray arm rotates	Make sure dishes are properly loaded. See the Loading section.
	Rattling silverware against door during wash	Tall utensils may be placed in the upper rack to avoid bumping against inner door during wash cycle.
	Motor hums	Dishwasher has not been used on a regular basis. If you do not use your dishwasher often, set it to fill and pump out once every week. This will help keep the seal moist.



GE Appliances Dishwasher Limited Warranty

GEAppliances.com

All warranty service is provided by our Factory Service Centers, or an authorized Customer Care® technician. To schedule service online, visit us at GEAppliances.com/service, or call GE Appliances at 800.GE.CARES (800.432.2737). Please have your serial number and your model number available when calling for service.

Servicing your appliance may require the use of the onboard data port for diagnostics. This gives a GE Appliances factory service technician the ability to quickly diagnose any issues with your appliance and helps GE Appliances improve its products by providing GE Appliances with information on your appliance. If you do not want your appliance data to be sent to GE Appliances, please advise your technician not to submit the data to GE Appliances at the time of service.

For the period of:	We will replace:
One year From the date of the original purchase	Any part of the dishwasher which fails due to a defect in materials or workmanship. During this limited one-year warranty , we will also provide, free of charge , all labor and related service to replace the defective part.

What is not covered:

- Service trips to your home to teach you how to use the product.
- Improper installation, delivery or maintenance.
- Failure of the product if it is abused, misused, or used for other than the intended purpose or used commercially.
- Replacement of house fuses or resetting of circuit breakers.
- Products which are not defective or broken, or which are working as described in the Owner's Manual.
- Damage to the product caused by accident, fire, floods or acts of God.
- Incidental or consequential damage caused by possible defects with this appliance.
- Defects or damage due to operation in freezing temperatures.
- Damage caused after delivery including damage from items dropped on the door.
- Product not accessible to provide required service.
- Cleaning or servicing of the air gap device in the drain line.

Staple your receipt here. Proof of the original purchase date is needed to obtain service under the warranty.

EXCLUSION OF IMPLIED WARRANTIES

Your sole and exclusive remedy is product repair as provided in this Limited Warranty. Any implied warranties, including the implied warranties of merchantability or fitness for a particular purpose, are limited to one year or the shortest period allowed by law.

In the United States:

This limited warranty is extended to the original purchaser and any succeeding owner for products purchased for home use within the USA. If the product is located in an area where service by a GE Appliances Authorized Servicer is not available, you may be responsible for a trip charge or you may be required to bring the product to an Authorized GE Appliances Service location for service. In Alaska, the limited warranty excludes the cost of shipping or service calls to your home.

Some states do not allow the exclusion or limitation of incidental or consequential damages. This limited warranty gives you specific legal rights, and you may also have other rights which vary from state to state. To know what your legal rights are, consult your local or state consumer affairs office or your state's Attorney General.

Warrantor: GE Appliances, a Haier Company
Louisville, KY 40225

In Canada:

This limited warranty is extended to the original purchaser and any succeeding owner for products purchased in Canada for home use within Canada. If the product is located in an area where service by a GE Appliances Authorized Servicer is not available, you may be responsible for a trip charge or you may be required to bring the product to an Authorized GE Appliances Service location.

Some provinces do not allow the exclusion or limitation of incidental or consequential damages. This limited warranty gives you specific legal rights, and you may also have other rights which vary from province to province. To know what your legal rights are, consult your local or provincial consumer affairs office.

Warrantor: MC Commercial Inc., Burlington, ON, L7R 5B6

Extended Warranties: Purchase a GE Appliances extended warranty and learn about special discounts that are available while your warranty is still in effect. You can purchase it online anytime at

GEAppliances.com/extended-warranty

or call 800.626.2224 during normal business hours. GE Appliances Service will still be there after your warranty expires.

Accessories

Looking For Something More?

GE Appliances offers a variety of accessories to improve your maintenance experiences!

Refer to the **Consumer Support** page for phone numbers and website information.

The following product and more are available:

Accessory

Non-wood countertop bracket kit—This is for installations which have non-wood countertops and includes side-mounting brackets and instructions for securing the dishwasher:

- **GPF65**

Consult your GE Appliance dealer to get the correct kit for your model.

Consumer Support

GE Appliances Website

Have a question or need assistance with your appliance? Try the GE Appliances Website 24 hours a day, any day of the year! You can also shop for more great GE Appliances products and take advantage of all our on-line support services designed for your convenience. In the US: GEAppliances.com

In Canada: GEAppliances.ca

Register Your Appliance

Register your new appliance on-line at your convenience! Timely product registration will allow for enhanced communication and prompt service under the terms of your warranty, should the need arise. You may also mail in the pre-printed registration card included in the packing material. In the US: GEAppliances.com/register

In Canada: Prodsupport.mabe.ca/crm/Products/ProductRegistration.aspx

Schedule Service

Expert GE Appliances repair service is only one step away from your door. Get on-line and schedule your service at your convenience any day of the year. In the US: GEAppliances.com/service or call 800.432.2737 during normal business hours.

In Canada: GEAppliances.ca/en/support/service-request or call 800.561.3344.

Extended Warranties

Purchase a GE Appliances extended warranty and learn about special discounts that are available while your warranty is still in effect. You can purchase it on-line anytime. GE Appliances Services will still be there after your warranty expires. In the US: GEAppliances.com/extended-warranty or call 800.626.2224 during normal business hours.

In Canada: GEAppliances.ca/en/support/purchase-extended-warranty or call 866.277.9842.

Remote Connectivity

For assistance with wireless network connectivity (for models with remote enable), in the US visit our website at GEAppliances.com/connect or call 800.220.6899.

In Canada: GEAppliances.ca/connect or call 800.220.6899

Parts and Accessories

Individuals qualified to service their own appliances can have parts or accessories sent directly to their homes (VISA, MasterCard and Discover cards are accepted). Order on-line today 24 hours every day.

In the US: GEApplianceparts.com or by phone at 877.959.8688 during normal business hours.

In Canada: GEAppliances.ca/en/products/parts-filters-accessories or call 800.661.1616.

Instructions contained in this manual cover procedures to be performed by any user. Other servicing generally should be referred to qualified service personnel. Caution must be exercised, since improper servicing may cause unsafe operation.

Contact Us

If you are not satisfied with the service you receive from GE Appliances, contact us on our Website with all the details including your phone number, or write to:

In the US: General Manager, Customer Relations | GE Appliances, Appliance Park | Louisville, KY 40225
GEAppliances.com/contact or call 800.626.2000

In Canada: Director, Consumer Relations, MC COMMERCIAL INC. | Suite 310, 1 Factory Lane | Moncton, N.B. E1C 9M3
GEAppliances.ca/en/contact-us or call 877.994.5366