



ELECTRIC PRESSURE WASHER OPERATOR'S MANUAL



Go to www.simpsoncleaning.com to register your new product.

If your pressure washer is not working properly or if there are parts missing or broken, please **DO NOT RETURN IT TO THE PLACE OF PURCHASE**. Contact our customer service department at 1-877-362-4271.

SAVE THIS MANUAL FOR FUTURE REFERENCE.

Part No. 7111613 Rev. 4 NOV. 2018

Thank you

for purchasing this quality-built electric pressure washer. We are pleased that you've placed your confidence in this brand. When operated and maintained according to the instructions in this manual, your pressure washer will provide many years of dependable service.

This manual contains safety information to make you aware of the hazards and risks associated with electric pressure washers and how to avoid them. Because the manufacturer does not necessarily know all the applications this electric pressure washer could be used for, it is important that you read and understand these instructions thoroughly before attempting to start or operate this equipment. **Save these original instructions for future reference.**

This electric pressure washer requires final assembly before use. Refer to the Assembly section of this manual for instructions on final assembly procedures. Follow the instructions completely.

Table of Contents

Operator Safety	2 - 3
Important Safety Instructions	4 - 5
Assembly	6 - 9
Features & Controls	10
Operations	11-13
Maintenance	13 -15
Troubleshooting	15
Warranty	16
Specifications	17

Operator Safety

SAVE THESE INSTRUCTIONS

Equipment Description

 **WARNING** Failure to read and follow the operator's manual and all operating instructions before using could result in death or serious injury.

- Read this manual carefully and become familiar with your electric pressure washer. Know its applications, its limitations, and any hazards involved.

Every effort has been made to ensure that the information in this manual is accurate and current.

However, we reserve the right to change, alter, or otherwise improve the product and this document at any time without prior notice.

Ground Fault Circuit Interrupter Protection

This pressure washer is provided with a ground-fault circuit-interrupter (GFCI) built into the plug of the power supply cord. This device provides additional protection from the risk of electric shock.

Should replacement of the plug or cord become necessary, use only identical replacement parts that include GFCI protection.

Grounding Instructions

This product must be grounded. If it should malfunction or breakdown, grounding provides a path of least resistance for electric current to reduce the risk of electric shock. This product is equipped with a cord having an equipment-grounding conductor and a grounding plug. The plug must be plugged into an appropriate outlet that is properly installed and grounded in accordance with all local codes and ordinances. **DANGER:** Improper connection of the equipment-grounding conductor can result in a risk of electrocution. Check with a qualified electrician or service personnel if you are in doubt as to whether the outlet is properly grounded. Do not modify the plug provided with the product – if it will not fit the outlet, have a proper outlet installed by a qualified electrician. Do not use any type of adaptor with this product

Thermal Relief Valve

When the temperature inside the pump rises too high, this valve will open and release a gush of water in an effort to lower the temperature inside the pump. The valve will then close.

Operator Safety

SAVE THESE INSTRUCTIONS

Equipment Description

 **WARNING** Failure to read and follow the operator's manual and all operating instructions before using could result in death or serious injury.

- Read this manual carefully and become familiar with your electric pressure washer. Know its applications, its limitations, and any hazards involved.

NOTICE The electric pressure washer is equipped with a main power ON/OFF switch. The switch should always be moved to the OFF position (0) when the electric pressure washer is not being used to prevent possible damage.

Motor Overload

The electric motor in this electric pressure washer is equipped with an overload protection device (thermostat). This device will automatically shut off the motor if the motor overheats or draws excessive current. If the overload protection device is tripped, disconnect the power supply by turning the master ON/OFF switch to the OFF (0) position. Let unit cool for 30 minutes. Then turn the master ON/OFF switch to the ON (I) position to resume operation.

Extension Cords

Use only 3-wire extension cords that have 3-prong grounding-type plugs and 3-pole cord connectors that accept the plug from the product. Use only extension cords that are intended for outdoor use. These extension cords are identified by a marking "Acceptable for use with outdoor appliances; store indoors while not in use." Use only extension cords having an electrical rating not less than the rating of the product. Do not use damaged extension cords. Examine extension cord before using and replace if damaged. Do not abuse extension cord and do not yank on any cord to disconnect. Keep cord away from heat and sharp edges. Always disconnect the extension cord from the receptacle before disconnecting the product from the extension cord.











WARNING:

To reduce the risk of electrocution, keep all connections dry and off the ground. Do not touch plug with wet hands. To avoid the possibility of the product plug or outlet getting wet, the operator should arrange a "drip loop" in the cord connecting the product to the outlet. The "drip loop" is that part of the cord below the level of the outlet, or the connector if an extension cord is used, to prevent water traveling along the cord and coming in contact with the outlet

Important Safety Information

Please read and understand this entire manual before attempting to assemble, operate or service the product. Follow the maintenance instructions specified in this manual.

Safety Symbols and Meanings

		
Read Manual	Electrical Shock	Fire
		
Slippery Surface	Fall	Fluid Injection
		
Projectile	Flying Objects	Chemical Burn
	Non-Potable Water	



Never spray yourself, others, animals, power sources, or the unit itself.

 The safety alert symbol indicates a potential personal injury hazard. A signal word (DANGER, WARNING, or CAUTION) is used with the alert symbol to designate a degree or level of hazard seriousness. A safety symbol may be used to represent the type of hazard. The signal word NOTICE is used to address practices not related to personal injury.

 **DANGER** indicates a hazard which, if not avoided, will result in death or serious injury.

 **WARNING** indicates a hazard which, if not avoided, could result in death or serious injury.

 **CAUTION** indicates a hazard which, if not avoided, could result in minor or moderate injury.

NOTICE indicates information considered important, but not hazard-related.

IMPORTANT SAFETY INSTRUCTIONS

WARNING - When using this product basic precautions should always be followed, including the following:

 **WARNING** Risk of electrocution. Use of an extension cord could cause electric shock or burn resulting in death or serious injury.

- DO NOT use an extension cord with this electric pressure washer. Your home's electrical circuit receptacle or extension cord may not provide lifesaving ground-fault circuit interruption protection.

 **WARNING** Risk of electrocution. Contacting both power conductors, at the same time could cause electric shock or burn resulting in death or serious injury

- Inspect cord before each use, DO NOT use if cord is damaged.
- The product is equipped with a ground fault circuit interrupter (GFCI) built into the power cord plug. If replacement of the plug or cord is required, use only identical replacement parts.
- Keep all connections dry and off the ground.
- DO NOT touch plug with wet hands.
- DO NOT run cord through doorways, windows, holes in ceilings, walls, or floors.
- DO NOT walk on cord.
- DO NOT drive over, drag or place objects over cord.
- DO NOT spray near power source.

 **WARNING** Use of electric pressure washer could create puddles and slippery surfaces. Risk of kickback. Spray gun could kickback causing you to fall resulting in death or serious injury.

- Operate the electric pressure washer from a stable surface.
- Do not overreach or stand on unstable support. Keep good footing and balance at all times.
- The cleaning area should have adequate slopes and drainage to reduce the possibility of a fall due to slippery surfaces.
- DO NOT use the electric pressure washer from a ladder, scaffolding, or any other similar location.
- Firmly grasp spray gun with both hands to avoid injury when spray gun kicks back.

 **WARNING** Risk of eye or bodily injury. Spray could splash back, propel objects or cause internal harm resulting in serious injury.



- Always wear indirect vented (chemical splash) safety goggles marked to comply with ANSI Z87.1 when using or in vicinity of this equipment. NEVER substitute safety glasses or dry condition goggles for indirect vented safety goggles.
- Know how to stop the pressure washer and bleed pressure quickly. Be thoroughly familiar with the controls.
- DO NOT allow CHILDREN to operate the electric pressure washer.
- Keep operating area clear of all persons.
- Inspect high pressure hose before each use. NEVER repair high pressure hose; replace it.
- DO NOT repair leaking connections with sealant of any kind; replace o-rings and gaskets.
- Keep hose connected to electric pressure washer and spray gun while system is pressurized.
- ALWAYS point spray gun in safe direction while system is pressurized and squeeze spray gun trigger to release high pressure, every time you turn off the pressure washer.
- **WARNING** Risk of Injection or Injury . DO NOT aim spray gun at people or animals.
- DO NOT drink from hose connected accessories.
- DO NOT secure spray gun in open position.
- DO NOT leave spray gun unattended while the electric pressure washer is in ON (I) position.
- DO NOT use a spray gun which does not have a trigger lock or trigger guard in place and in working order.
- Always be certain spray gun and accessories are correctly attached.
- Stay alert – watch what you are doing.
- DO NOT operate the product when fatigued or under the influence of alcohol or drugs.
- To reduce the risk of injury, DO NOT operate near children.
- Close supervision is necessary when this product is used near children.

 **WARNING** The high pressure stream of water that this equipment produces could cut through skin and its underlying tissues, resulting in serious injury and possible amputation.



- Spray gun traps high water pressure, even when motor is stopped and water is disconnected, which could result in serious injury.
- NEVER aim spray gun at people, animals, or plants.
 - ALWAYS point spray gun in safe direction, squeeze spray gun trigger to release high pressure, every time you turn off pressure washer.



WARNING Risk of fire. Spraying flammable liquids could result in death or serious injury.

- DO NOT spray flammable liquids.



WARNING Chemical Burn Hazard.

Chemicals could cause burns resulting in death or serious injury.

- Always wear indirect vented (chemical splash) safety goggles marked to comply with ANSI Z87.1 when using chemicals.
- DO NOT substitute safety glasses or dry-condition goggles for indirect vented safety goggles.
- DO NOT use caustic liquid with electric pressure washer.
- Use ONLY pressure washer safe detergents/soaps. Follow all manufacturers instructions.



WARNING This product can expose you to chemicals including lead and lead compounds, which are known to the State of California to cause cancer and birth defects or other reproductive harm. For more information go to [www. P65Warnings.ca.gov](http://www.P65Warnings.ca.gov).

NOTICE High pressure spray could damage fragile items including glass.

- DO NOT point spray gun at glass when using MAX spray pattern in selector nozzle.
- NEVER aim spray gun at plants.

NOTICE Improper treatment of electric pressure washer could damage it and shorten its life.

- If you have questions about intended use, ask dealer or contact authorized service center.
- DO NOT operate units with broken or missing parts, or without protective housing or covers.
- DO NOT by-pass any safety device on the electric pressure washer.
- DO NOT modify the electric pressure washer in any way.
- Before starting the electric pressure washer in cold weather, check all parts of the equipment to be sure ice has not formed there.

MOVING INSTRUCTIONS

- DO NOT move the electric pressure washer by pulling on hoses. Move unit using the transport handle supplied.
- Use ONLY branded accessories intended for use with this product.

NOTICE This appliance is not intended for use by children and other persons whose physical, sensory, or mental capabilities or lack of experience and knowledge prevents them from using the appliance safely without supervision or instruction by a responsible person.

Children should be supervised by a responsible person to ensure that they do not play with the appliance

SAVE THESE INSTRUCTIONS

Assembly



Read entire operator's manual before you attempt to assemble or operate your new electric pressure washer.

Your electric pressure washer requires some assembly but is quickly ready for use.

Items Not Included

- Garden hose

Unpack Electric Pressure Washer

1. Remove everything from carton.
2. Ensure you have all included items prior to assembly

Items Included in the Carton

- Main unit
- Handle
- Wheels (2) and hardware
- Spray gun
- High pressure hose
- Quick Connect (QC) spray tips (3)
 - Yellow nozzle 15°
 - Black Foam nozzle
 - Turbo nozzle
- Spray wand
- Detergent tank
- Operator's Manual

Check all contents. If any parts are missing or damaged, call the customer service .

Become familiar with each component before assembling the electric pressure washer. Identify contents with the illustration shown in *Features and Controls*.

Prior to Operation

1. Read and perform the following instructions while paying close attention to all warnings and notices.

NOTICE Connect ONLY to water source capable of supplying a minimum of 5 gpm (18.9 lpm) and no less than 20 psi (1.38 bars) at the electric pressure washer end of garden hose. Inspect all equipment, hoses and accessories thoroughly before each use, DO NOT use if damaged.

- ONLY use branded accessories intended for use with this product.
- For optimum performance, DO NOT use a garden hose that exceeds 50 feet in length (30 feet max if water source is a well).
- Replace only with original equipment parts.

Lubricate O-Rings

Lubrication of o-rings is extremely important for installation and operation. The use of a lubricant (petroleum or synthetic grease) during assembly helps seat o-rings properly and provides an improved seal. It also helps protect the o-ring from damage by abrasion, pinching or cutting and extends the life of the o-ring.

NOTICE ALWAYS apply a small amount of lubricant on o-rings prior to assembling the garden hose to the pump (A), high pressure hose (pump end) (B), high pressure hose (gun end) (C), spray wand (gun end) (D).

Lubricate all connections shown below, following these instructions:

1. Inspect and clean connecting surfaces prior to lubrication and assembly.
2. Use lubricants sparingly during assembly; a light film is all that is required.
3. Use a small brush or cotton swab to apply grease directly to o-rings where they are not accessible (QC fitting, M22 fitting).

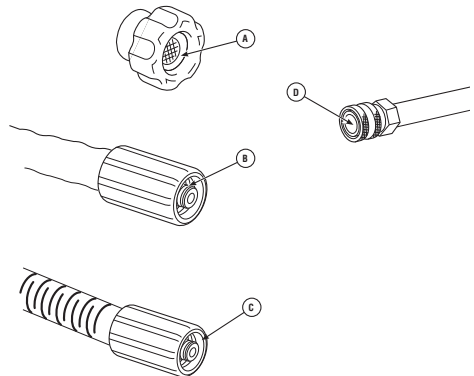

Assemble Main Unit

Pay close attention to the illustrations on this page.

NOTICE Depending on the model, there may be slight differences in assembly.

A **Install the Wheels**
Slide the axle pin through the wheel, formed washer, frame and other formed washer. Slide clip through hole in axle pin to secure wheel in place. Repeat steps for second wheel.

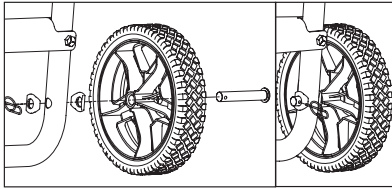

B **Install the Handle**
Place handle onto frame, depress the snap buttons, and slide the handle assembly onto the frame until snap buttons snap into place.

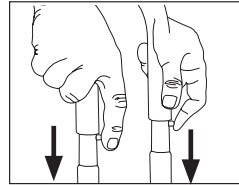

Connect Hoses and Water Supply

NOTICE DO NOT run the pump without the water supply connected and turned on.

• Damage to equipment resulting from failure to follow this instruction will void warranty.

1. Uncoil high pressure hose (A) and attach end of hose to base of spray gun (B). Tighten by hand.

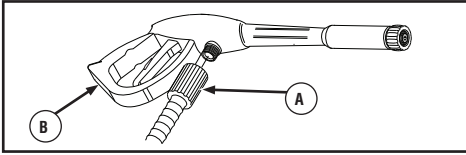

WARNING The high pressure stream of water that this equipment produces could cut through skin and its underlying tissues, resulting in serious injury and possible amputation.

Spray gun traps high water pressure, even when motor is stopped and water is disconnected, which could result in serious injury.

- NEVER aim spray gun at people, animals, or plants.
- ALWAYS point spray gun in safe direction, squeeze spray gun trigger to release high pressure, every time you turn off pressure washer.

2. Attach end of high pressure hose (A) to high pressure outlet (C) on pump. Tighten by hand.

3. Run water through your garden hose for 30 seconds to clean out any debris.

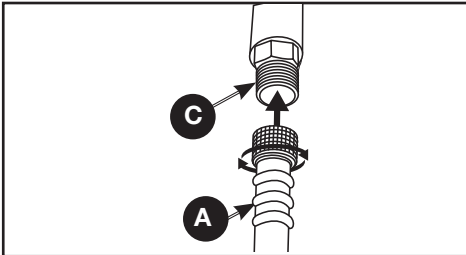

NOTICE DO NOT siphon standing water for the water supply. Use ONLY cold water (less than 90°F (32°C)).

4. Before connecting garden hose (D) to water inlet (E), inspect inlet screen (F). Clean screen if it contains debris or have it replaced if damaged. DO NOT run pressure washer if inlet screen is damaged.

Connect to Individual Branch Circuit Only.



IF CONNECTION IS MADE TO A POTABLE WATER SYSTEM, THE SYSTEM SHALL BE PROTECTED AGAINST BACKFLOW.

NOTICE Using a One Way Valve (vacuum breaker or check valve) at pump inlet could cause pump or inlet connector damage.

• There MUST be at least 10 ft. (3 m) of unrestricted garden hose between the pressure washer inlet and any device, such as a vacuum breaker or check valve.

• Damage to equipment resulting from failure to follow this instruction will void warranty.

5. Connect the garden hose (D) (not to exceed 50 ft. (15 m) in length) to the water inlet (E). Tighten by hand.

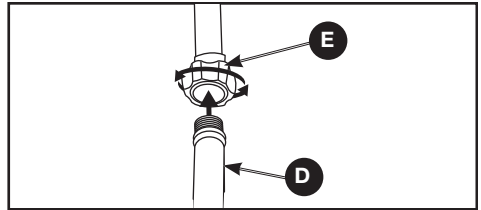

WARNING Risk of eye injury.



Spray could splash back or propel objects resulting in serious injury.

- Always wear properly rated eye protection such as safety goggles or face shield comply with ANSI Z87.1, while spraying. (safety glasses do not provide full protection.) when using or in vicinity of this equipment. NEVER substitute safety glasses or drycondition goggles for indirect vented safety goggles.
- NEVER substitute safety glasses or dry-condition goggles for indirect vented safety goggles..



6. Turn ON the water, open the lock (F) on the gun and squeeze the trigger for 30 seconds to purge the pump system of air and impurities.

Checklist Before Starting Pump Motor

Review the unit's assembly to ensure you have performed all of the following.

1. Be sure to read Operator Safety and Operation before using the electric pressure washer.
2. Check for properly tightened hose connections.
3. Check to make sure there are no kinks, cuts, or damage to hoses.
4. Provide a proper water supply at an adequate flow.
5. Plug electrical power cord into an electrical circuit rated for 120 Volts AC at 15 Amps that is properly installed in accordance with all local codes and ordinances

NOTE The power supply must be 120 V, 60 Hz and a minimum 15 amp dedicated circuit.

Connect Wand and Spray Tip

5. Turn ON water, point gun in a safe direction, open trigger lock small lever and squeeze trigger to purge pump system of air and impurities.
6. Attach spray wand to spray gun. Tighten by hand.
7. Release trigger.

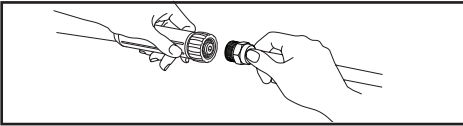

8. Choose spray tip you want to use, pull back on collar of spray wand, insert spray tip and release collar. Tug on spray tip to make sure it is securely in place. See How to Use Spray Tips, page 12.

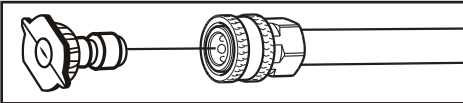

Features and Controls



Read the Operator's Manual and safety rules before operating your electric pressure washer.

Compare the illustrations with your electric pressure washer to familiarize yourself with the locations of various controls and adjustments. Save this original manual for future reference.

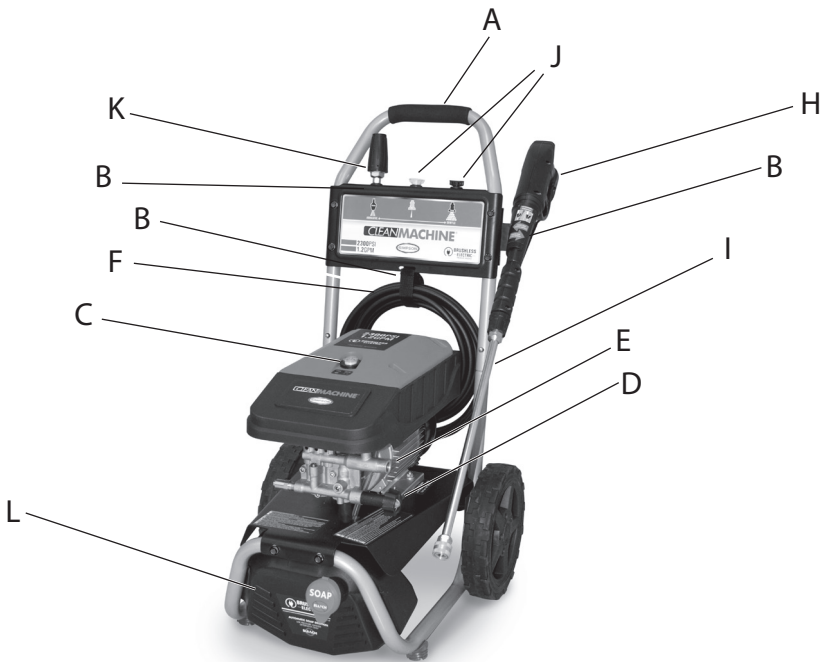

A - Handle

B - Accessory Storage — Provides convenient storage for standard and optional accessories.

C - Master ON/OFF Switch — Push switch in to turn pressure washer ON. Push switch to turn pressure washer OFF.

D - Water Supply Inlet — Connect to water supply using a 50 ft. (15.24 m) maximum garden hose, 30 ft. max if water source is a well.

E - High Pressure Water Outlet — Connection for high pressure hose.

F - High Pressure Hose — Connect one end to high pressure water outlet and the other end to spray gun.

G - Electric Cord with GFCI — The electric pressure washer and operator is protected by a ground fault circuit interrupter (GFCI). (not shown, see page 12)

H - Spray Gun — Controls the application of water onto cleaning surface with trigger device. Includes trigger lock.

I - Spray Wand — Allows you to switch between different spray tips.

J - Spray Tips — Quick Connect (QC) spray tips
Yellow High Pressure Nozzle with 15° Fan Spray Pattern
Black Low Pressure Nozzle to apply detergent to surfaces

K - Turbo Spray Tip — Whirls a powerful pin-point jet of water for intense cleaning.

L - Detergent Tank — Prepare detergent solution as required by job.

Operation

Start Pressure Washer

Follow the instructions below in the order presented.



WARNING Risk of eye injury.

Spray could splash back or propel objects resulting in serious injury.

Always wear indirect vented (chemical splash) safety goggles marked to comply with ANSI Z87.1 when using or in vicinity of this equipment. NEVER substitute safety glasses or dry-condition goggles for indirect vented safety goggles.

1. Place the electric pressure washer near an outside water source capable of supplying water at a flow rate greater than 5 GPM (18.9 LPM) and no less than 20 PSI (1.38 BARS) at the electric pressure washer end of garden hose. DO NOT siphon supply water.
2. Connect garden hose to water inlet.
3. Check that high pressure hose is tightly connected to spray gun and high pressure outlet. See Connect Hoses and Water Supply.

NOTICE DO NOT run the pump without the water supply connected and turned on.

- Damage to equipment resulting from failure to follow this instruction will void warranty.
4. Turn ON water, point gun in a safe direction, open trigger lock small lever and squeeze trigger to purge pump system of air.
 5. Install desired spray tip into wand. See Connect Wand and Spray Tips.
 6. Press master ON/OFF switch (C) to OFF (O) position

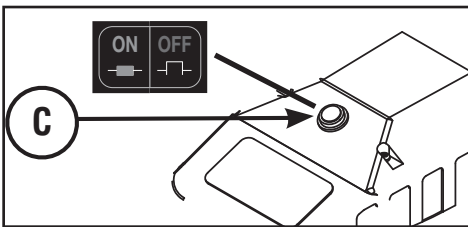

WARNING

Do not allow the unit to run for more than two minutes without the gun trigger being pulled. This could cause overheating and damage to the pump. When the temperature inside the pump rises too high, the thermal relief valve will open and release a spray of water from the pump to lower the internal temperature. The valve will then close.



WARNING Risk of electrocution. Use of an extension cord could cause electric shock or burn resulting in death or serious injury.

DO NOT use an extension cord with this electric pressure washer. Your home's electrical circuit receptacle or extension cord may not provide lifesaving ground-fault circuit interruption protection.

7. Plug electrical power cord into an electrical circuit rated for 120 Volts AC at 15 Amps that is properly installed in accordance with all local codes and ordinances. The indicator light on the GFCI should be ON.

NOTICE The power supply must be 120 V, 60 Hz and a minimum 15 amp dedicated circuit.

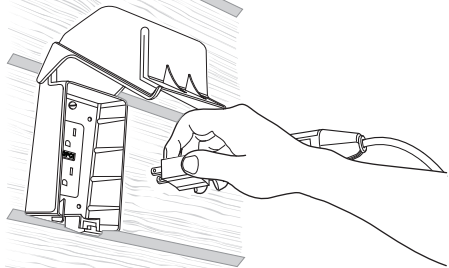

NOTICE The indicator light must be ON for the electric pressure washer to operate.



WARNING Risk of electrocution. Non-operating ground fault circuit interrupter (GFCI) could result in death or bodily injury. If indicator light does not stay ON after test and reset, do not use GFCI.

8. Press TEST button (B). The indicator light (D) should be OFF.

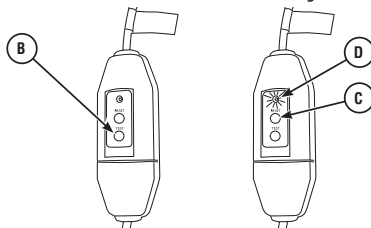

9. Press RESET button (C). The indicator light (D) should be ON.
- NOTICE** DO NOT use the electric pressure washer if above test fails.

10. Press the master ON/OFF switch (A) to the Pressure Washer ON (I) position.
11. Point gun in a safe direction, open trigger lock small lever and squeeze trigger. The electric pressure washer motor will start as the spray gun trigger is depressed and will continue to run even when released.

The electric pressure washer is now ready for use. Instructions for use of the supplied accessories are given later in this section.

How to Stop Your Electric Pressure Washer

The electric pressure washer motor runs only when the ON/OFF switch is in the ON (I) Position. To stop the electric pressure washer and turn off the motor:

1. Release spray gun trigger.
2. Press the master ON/OFF switch to the OFF (O) position.
3. Turn off water supply.
4. ALWAYS point spray gun in a safe direction and squeeze spray gun trigger to relieve built up pressure in the unit.

 **WARNING** The high pressure stream of water that this equipment produces could cut through skin and its underlying tissues, resulting in serious injury and possible amputation.

Spray gun traps high water pressure, even when motor is stopped and water is disconnected, which could result in serious injury.

- Keep high pressure hose connected to pump and spray gun while system is pressurized.
- ALWAYS point spray gun in safe direction, squeeze spray gun trigger to release high pressure, every time you turn off pressure washer.

5. Disconnect GFCI plug from outlet and coil power cord.
6. Flush detergent tank (if used) by rinsing out all remaining detergent.
7. Coil and store power cord, high pressure hose, spray gun and accessories.

Spray Tips

There are three spray tips supplied with the pressure washer. The **turbo spray tip** whirls a powerful pin-point jet of water for intense cleaning. The soap tip is for general soap applications, and the high pressure tip is for various high pressure applications.



Black Detergent Nozzle - Low Pressure Foamer .
Use to apply detergent.



Yellow Cleaning Nozzle - High Pressure 15°
Siding / Patios / Decks / Driveways / Garage Floors



Intense Cleaning Turbo Paint Removal / Oil Stains / Rust Removal

Usage Tips

- For most effective cleaning, keep spray tips 8 - 24 inches away from cleaning surface.
- If spray tips get too close, especially using a high pressure spray tip, you may damage surface being cleaned.
- DO NOT get closer than 6 inches when cleaning tires.

Applying Detergent



WARNING Chemical Burn Hazard.



Chemicals could cause burns resulting in death or serious injury.

- Always wear indirect vented (chemical splash) safety goggles marked to comply with ANSI Z87.1 when using chemicals.
- DO NOT substitute safety glasses or dry-condition goggles for indirect vented safety goggles.
- DO NOT use caustic liquid with electric pressure washer.
- Use ONLY pressure washer safe detergents/soaps. Follow all manufacturers instructions.

1. Review use of spray tips in Spray Tips.
2. Prepare your detergent solution as required by job to be performed.
3. Check that detergent siphoning tube (transparent) is connected at bottom of detergent tank.
4. Install soap tip.

NOTICE Detergent cannot be applied with turbo or high pressure spray tips.

5. Make sure garden hose is connected to water inlet. Check that high pressure hose is connected to spray gun and high pressure outlet. Turn on water.

NOTICE You must attach all hoses before you start the pressure washer.

6. Start the pressure washer as instructed in Start Pressure Washer.
7. Apply detergent to a dry surface, starting at lower portion of area to be washed and work upward using long, even, overlapping strokes.
8. Allow detergent to "soak in" for 3-5 minutes before washing and rinsing. Reapply as needed to prevent surface from drying. To prevent streaking, Do Not allow detergent to dry on surface.

Rinsing

1. Remove foam tip from wand, install another tip.
2. Keep spray gun a safe distance from area you plan to spray.

 **WARNING** Risk of kickback.
Spray gun could kickback causing you to fall resulting in death or serious injury.

- Operate the electric pressure washer from a stable surface.
- Be extremely careful if you must use the electric pressure washer from a ladder, scaffolding, or any other similar location.
- Firmly grasp spray gun with both hands when using power spray modes to avoid injury when spray gun kicks back

3. Apply a high pressure spray to a small area and then check surface for damage. If no damage is found, you can assume it is okay to continue rinsing.
4. Start at top of area to be rinsed, working down with same overlapping strokes as you used for cleaning.

Other Cleaning Tips

- NEVER leave the electric pressure washer unattended while it is plugged into an electrical outlet and while water is supplied to the equipment.
- If you have the nozzle too far away from the surface being washed, the cleaning may not be as effective.

How to Store Accessories

The unit is equipped with areas to store your high pressure hose, spray gun, spray wand, and power cord.

NOTICE Flush detergent and siphoning system after each use by filling detergent tank with clean water, then run pressure washer with soap tip for 1-2 minutes.

Maintenance

General Recommendations

Regular maintenance will improve the performance and extend the life of the electric pressure washer.

The electric pressure washer's warranty does not cover items that have been subjected to operator abuse or negligence. To receive full value from the warranty, the operator must maintain the electric pressure washer as instructed in this manual, including proper storage.

NOTICE Should you have questions about replacing components on your electric pressure washer, please call customer center for assistance.

Before Each Use

1. Clean debris.
2. Check water inlet screen for debris or damage.
3. Check high pressure hose for leaks.
4. Check spray gun operation.

Electric Pressure Washer Maintenance

Clean Debris

Daily or before use, clean accumulated debris from electric pressure washer. Inspect cooling air slots and openings on the electric pressure washer. These openings must be kept clean and unobstructed.

The electric pressure washer parts should be kept clean to reduce the risk of overheating and ignition of accumulated debris.

- Use a damp cloth to wipe exterior surfaces clean.

NOTICE Improper treatment of the electric pressure washer can damage it and/or shorten its life.

- DO NOT insert any objects through cooling slots.

Check and Clean Water Inlet Screen

Examine water inlet screen. If the screen is dirty, clean with a small brush and water. If the screen is damaged, replace it.

Check High Pressure Hose

The high pressure hose can develop leaks from wear, kinking, or abuse. Inspect the hose each time before using it. Check for cuts, leaks, abrasions or bulging of cover, damage or movement of couplings. If any of these conditions exist, replace the hose immediately.



WARNING The high pressure stream of water that this equipment produces could cut through skin and its underlying tissues, resulting in serious injury and possible amputation.

- NEVER repair high pressure hose. Replace it.
- Replacement hose rating MUST equal or exceed maximum pressure rating of unit.

Check Spray Gun

Examine the hose connection to the spray gun and make sure it is secure. Test the trigger (A) by open trigger lock small lever (B) and making sure the trigger “springs back” into place when you release it. You should not be able to press the trigger without pressing the trigger lock button. Replace spray gun immediately if it fails any of these tests.

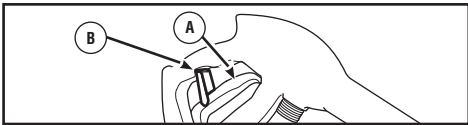

Spray Tip Maintenance

Excessive pump pressure can cause a pulsing sensation felt while squeezing the spray gun trigger. The principal cause of excessive pump pressure is a spray tip clogged or restricted with foreign materials such as dirt, etc. A clogged spray tip could lead to pump cycling ON/OFF or not turning on even when there is some flow.

1. Press the master ON/OFF switch to the OFF (0) position. Remove power cord plug from electrical outlet.
2. Disconnect water supply at the electric pressure washer.
3. ALWAYS point spray gun in a safe direction, open trigger lock small lever and squeeze spray gun trigger to release retained high water pressure.



WARNING The high pressure stream of water that this equipment produces could cut through skin and its underlying tissues, resulting in serious injury and possible amputation.

Spray gun traps high water pressure, even when motor is stopped and water is disconnected, which could result in serious injury

- Keep high pressure hose connected to pump and spray gun while system is pressurized.
- ALWAYS point spray gun in safe direction, squeeze spray gun trigger to release high pressure, every time you turn off pressure washer.

4. Remove spray tip from end of spray wand.
5. Use a small paper clip to free any foreign material clogging or restricting any of the spray tips.
6. Using a garden hose, remove additional debris by back flushing water through spray wand. Back flush between 30 to 60 seconds.
7. Reinstall spray tip into spray wand.
8. Make sure garden hose is connected to water inlet. Check that high pressure hose is connected to spray gun and pump. Turn on water.
9. Plug power cord into electrical outlet and press the master ON/OFF switch to the ON (I) position.
10. Test the electric pressure washer by operating with the wand.

Pump and Motor Maintenance

The electric pressure washer does not require any maintenance to the pump or motor. Both assemblies are pre-lubricated and sealed, requiring no additional lubrication ever.

After Each Use

Water should not remain in the unit for long periods of time. Sediments or minerals can deposit on pump parts and “freeze” pump action. Follow these procedures after every use:

1. Fill detergent tank with clean water (if used).
2. Run the electric pressure washer with foamer spray tip. Flush for one or two minutes.
3. Press the master ON/OFF switch to the OFF (0) position.
4. Turn off water supply, point gun in a safe direction, and squeeze trigger to relieve trapped pressure, and let engine cool.
5. Disconnect hose from spray gun and high pressure outlet on pump. Drain water from hose, spray gun, and spray wand. Use a rag to wipe off the hose.
6. Drain water from pump by tipping unit to the side (water inlet / outlet facing down) for two minutes.
7. Wrap high pressure hose and store using the strap on the back of the dashboard.
8. Coil power cord.
9. Store spray gun/wand in gun holster. Store spray tips in holes on dashboard.
10. Store unit in a clean, dry area.
11. If storing for more than 30 days see Winter or Long Term Storage.

Winter or Long Term Storage

Follow steps After Each Use.

NOTICE Water left in pump could freeze and permanently damage pump. Freeze damage is not covered under warranty.

Protecting the Pump

To protect the pump from damage caused by mineral deposits or freezing, use **POWERWASHER® Pump Guard**. This prevents freeze damage and lubricates plunger and seals.

NOTICE Pump Guard is available as an optional accessory. It is not included with the electric pressure washer.

NOTICE You must protect your unit from freezing temperatures.

- Failure to do so will permanently damage your pump and render your unit inoperable.

CAUTION: Always store your pressure washer in a location where the temperature will not fall below 40 °F (4 °C). The pump in this machine is susceptible to permanent damage if frozen. **FREEZE DAMAGE IS NOT COVERED BY THE WARRANTY.**

Final Storage Procedures

1. Coil power cord.
2. Coil high pressure hose.
3. Store spray gun and accessories appropriately.
4. Store unit in a clean, dry area that is protected from freezing temperatures.
5. Cover unit with a suitable protective cover that does not retain moisture.

Troubleshooting

Problem	Cause	Correction
Pump has following problems: failure to produce pressure, erratic pressure, chattering, loss of pressure, low water volume.	<ol style="list-style-type: none"> 1. Water inlet is blocked. 2. Inadequate water supply. 3. Garden hose is kinked or leaking. 4. Clogged water inlet screen. 5. Water supply is over 90°F (32°C). 6. High pressure hose is blocked or leaks. 7. Nozzle is obstructed. 8. Pump is faulty. 	<ol style="list-style-type: none"> 1. Clear inlet. 2. Provide adequate water flow. 3. Straighten garden hose or replace if leaking. 4. Check and clean water inlet screen. 5. Provide cooler water supply. 6. Clear blocks in high pressure hose or replace hose. 7. Clean nozzle. 8. Contact the authorized service center.
Unit fails to start when spray gun trigger is squeezed.	<ol style="list-style-type: none"> 1. Water supply is not turned on. 2. Unit is not turned on. 3. Garden hose is too long. 	<ol style="list-style-type: none"> 1. Turn on water supply. 2. Press the master ON/OFF switch to the Pressure Washer ON () position. Reset GFCI. 3. Use only 50 ft. (15.24 m) maximum garden hose.
Detergent fails to mix with spray.	<ol style="list-style-type: none"> 1. Transparent tube is clogged or cracked. 2. Transparent tube is not attached to detergent tank. 3. Tip wrong 	<ol style="list-style-type: none"> 1. Clean or replace transparent tube. 2. Attach transparent tube to bottom of detergent tank. 3. Intall soap tip on wand

Service Information

Do not return this product to your retailer.
Please contact our customer service department
at www.simpsoncleaning.com or 1-877-362-4271.

Limited Warranty

Limited Warranty

This product is warranted against defects in material and workmanship for a period of one year on all components excluding the spray gun, high pressure hose, wands, nozzles, and ground fault circuit interrupter (GFCI) which are only covered for 90 days; effective from the date of retail purchase and is not transferable.

This warranty excludes incidental/ consequential damages and failures due to misuse, abuse or normal wear and tear. This warranty applies only to products used in consumer (home) applications.

This warranty does not apply to commercial or rental applications.

This warranty gives you specific rights, and you may also have other rights, which vary from state to state.

Please complete and return the enclosed Customer Information Card.

Return of this card is not required to validate this warranty. A store issued receipt or credit card statement showing the purchase date is an acceptable warranty validation. Please retain one of these documents in your records.

If you have any questions, please contact our customer service department at www.simpsoncleaning.com or 1-877-362-4271.

What is covered: Replacement parts and labor. Please note that we reserve the right to repair or replace the product as we deem appropriate.

What is not covered: This warranty does not include such parts as nozzles which must be replaced as part of normal maintenance of the equipment, rather than as the result of a defect. Transportation charges to warranty center for defective products.

Transportation charges to consumer for repaired products. Damages caused by abuse, accident, improper repair, or failure to perform normal maintenance.

Use of improper chemicals or noncompliance with the operator manual's instructions. Sales outside of the United States or Canada. Any other expense including consequential damages, incidental damages, or incidental expenses, including damage to property. Some states do not allow the exclusion or limitation of incidental or consequential damages, so the above limitation

or exclusion may not apply to you. This warranty does not cover damage resulting from failure to observe any of the following conditions:

- 1) The inlet water pressure must be between 20 and 100 psi.
- 2) The inlet water temperature must not exceed 90°F (32°C)
- 3) The unit should not be stored in areas where temperatures may drop below 40°F (4°C)

Implied Warranties

Any implied warranties, including the implied warranties of merchantability and fitness for a particular purpose, are limited in duration to one year on all components excluding the spray gun, high pressure hose, wand, and ground fault circuit interrupter (GFCI) which are only covered for 90 days; effective from the date of retail purchase and is not transferable. This warranty excludes incidental/consequential damages and failures due to misuse, abuse or normal wear and tear. This warranty applies only to products used in consumer (home) applications. This warranty does not apply to commercial or rental applications. This warranty gives you specific rights, and you may also have

other rights, which vary from state to state.

Some states do not allow the exclusion or limitation of implied warranties or incidental or consequential damages, so the above limitation or exclusion may not apply to you.

Electric Pressure Washer

Product Specifications

Peak Pressure | 2300 PSI

Peak Water Flow | 1.2 GPM

Water Supply Temperature | 5°C (41°F) - 90°F (32°C)

Motor | Induction type

Rated Voltage | 120 Volts AC

Current | 13 Amps

Values are within manufacturing tolerance of (+/- 10%)
Complies with CETA Performance Standard CPC-100





Distributed by: FNA Group Inc. Pleasant Prairie, WI 53158