

User Manual

Smart Projector T2/T2 Plus

EN

Contents

English	01
English	01
English	01
English	01
English	01
English	01
English	01

Dear customer,

Thank you for choosing Yaber Projector. Please kindly read this QSG carefully before using the projector.

Scan the QR code on the next page to get the detailed product user manual and video guideline.

We understand that using a projector can sometimes be confusing, however, leaving a review on the product page doesn't help for your perfect experience :(Please let us help you! We really hope to get your kind feedback, and we'll surely serve you with a quick & satisfying solution as soon as possible!

Many common problems can usually be solved with appropriate setting adjustments, such as battery issues, instability of auto focus or keystone, Dolby sound issues, WIFI or Bluetooth connection.

If you have any questions, please send your order No. and problem in mail subject, **e.g. [US+Model No. +000-0000000-0000000+your problem]** to our mailbox, faster solved if you kindly **send videos or pictures in the same time**. Our service team will serve you within 24 hours as soon as possible.

: service@yaber.com (Buy from Amazon)
: aftersales@yabertech.com (Buy from Other authorized partners)

Our R&D Team dedicating themselves to bringing you a wonderful & warm watching experience with your families & friends. Our QC Team set a strict full inspection process and well package before shipment to ensure good quality and functionality for every Yaber Projector.

If you encounter any problems, please give us a chance to serve you and know more about YABER Projector. :)

We're committing to provide you with the most satisfactory solution. Thanks for your kind understanding and patience in advance.

YABER Projector Consumer Service Team



The terms HDMI, HDMI High-Definition Multimedia Interface, HDMI trade dress and the HDMI Logos are trademarks or registered trademarks of HDMI Licensing Administrator, Inc.



PDF user manual

Scan and download



Video Guideline

Scan to learn more

Where to Get More Help

Purchased from Amazon : ✉ service@yaber.com

Purchased from other Authorized Partners : ✉ aftersales@yabertech.com

🌐 www.yaber.com 📺 [@yaberofficial](https://www.youtube.com/@yaberofficial) 📘 [@yaber.projector](https://www.facebook.com/yaber.projector)

Package Contents

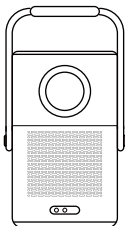

Projector

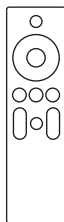

Remote Control
(For T2)



Lens Cover



QSG & FAQ

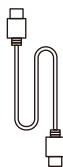

HDMI Cable

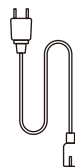

Power Cord

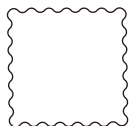

Cleaning Cloth

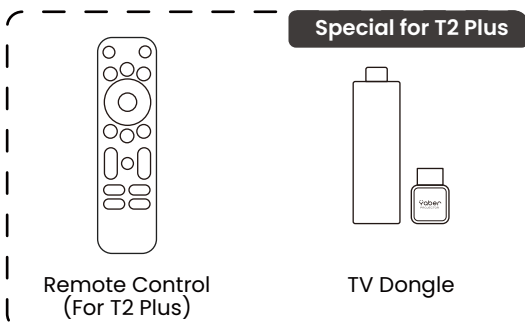

Remote Control
(For T2 Plus)

TV Dongle

Product Overview

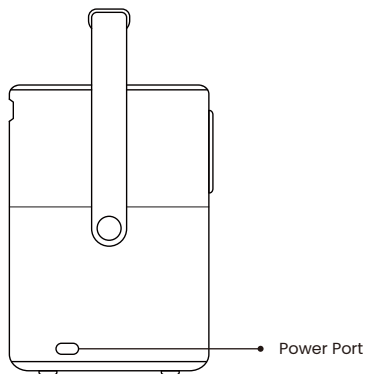
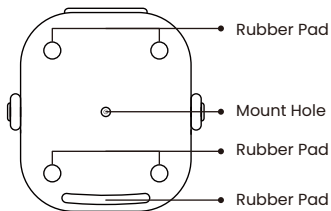
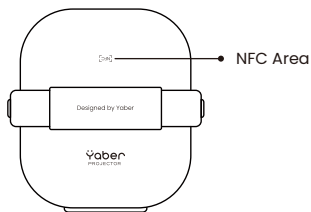
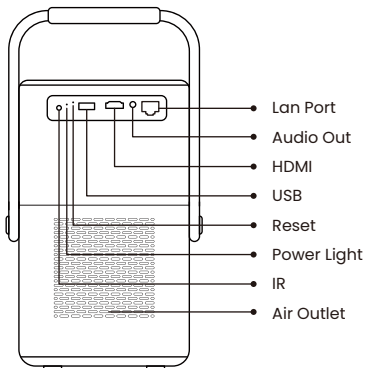
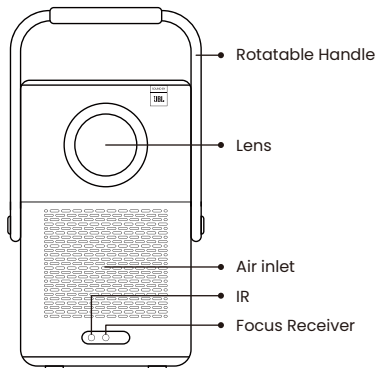

TV Dongle Overview (Special for T2 Plus)

TV Dongle

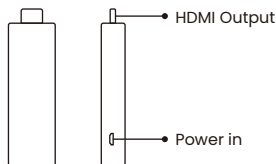

Adapter(Power in + Video Source)

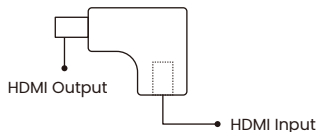

Tv Dongle Installation



Notice: When using Dongle on the T2/T2 Plus, it must be connected via the Yaber Adapter. The Yaber adapter combines power and video source function .

Step1: Connect the dongle with the adapter

Step2: Connect the adapter with the HDMI port of the projector

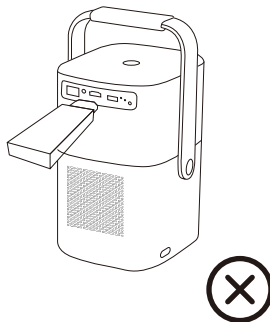
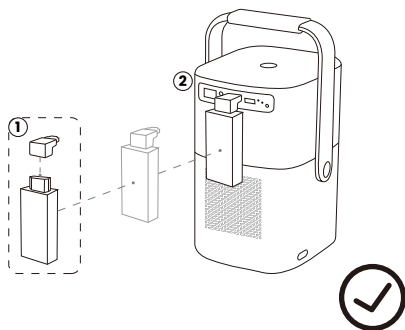

Getting Started

Attentions for battery

1. Please make sure to use the projector's power cord for charging.
2. Due to long-time transportation, the battery may lost, and show not fully charged when you turn on the projector for the first time. It's normal and workable.
3. When the battery is lower than 20%, the system will prompt you to charge. The projector is still allowed to be used, however we recommend that you turn it off and charge it to extend battery life.
4. In battery mode, the picture brightness will be reduced to extend the usage time.
5. The battery is not removable, please do not disassemble the machine without authorization. if you encounter any problems, please feel free to contact us.
6. When the projector is completely run out of power, please turn it on again after charging for 15 minutes.
7. The projector does not support external charging.

Powering on

1. Connect the power cord to the Yaber T2/T2 Plus.
2. Connect the power cord to the power socket.
3. Click the power button to turn on the device.

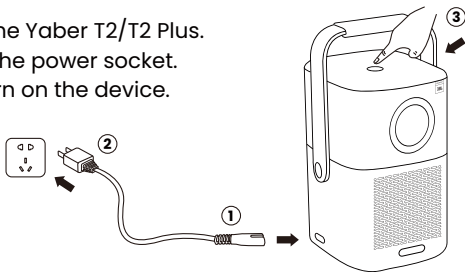

Placement

For a better image, please try to place the projector on a stable, flat surface.

If you need to adjust the screen at a larger angle, you can rotate the carrying handle to the bottom and it will provide you with support under 15°.

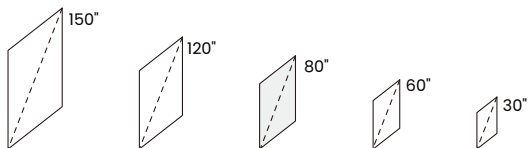
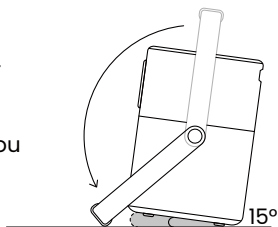

4.00	3.20	2.13	1.60	0.80	Meters
13.12	10.50	6.99	5.25	2.62	feet

 **Tip: The recommended Screen size is 80 inches.**

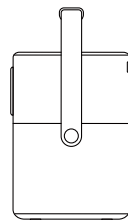

Battery Mode

- 2.5 Hours of use in battery mode.
- The brightness will be reduced to extending battery's endurance time.
- You can also adjust the brightness by adjusting the settings; However, battery's endurance time will decrease.

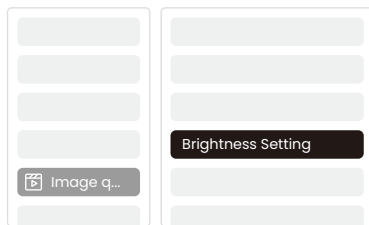

Charging Time

From 0% ~ 100%	
Projector turned off	3 Hours
Projector turned on	10 Hours

Charging Indicator Light

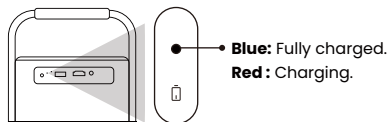

Remote Control

Only for T2

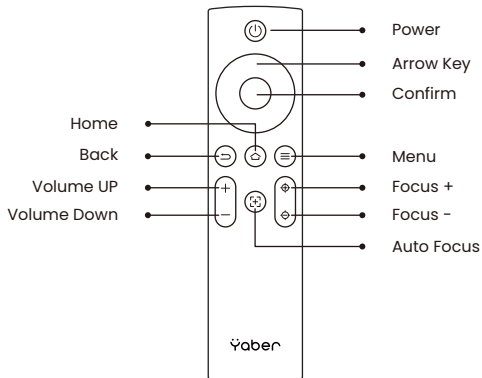

Only for T2 Plus

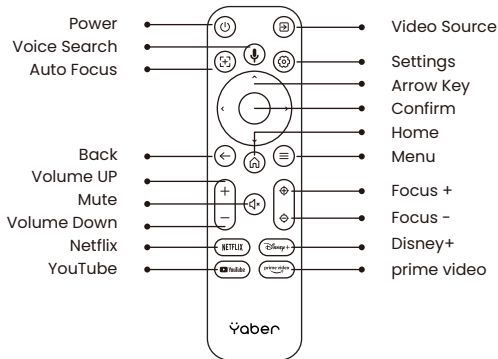



Notice: When using Google TV for the first time, you will need to follow the guidelines and long press  and  to pair with.

Image Adjustment

Keystone Correction:

Auto Keystone Correction is on by default. If you need to turn it off, you can turn it off from [Settings]-[Projection Mode]-[Auto Keystone].

Manual Keystone Correction:

If you need to further adjust the screen, you can select [Manual Keystone Correction] in the settings and adjust the screen by dragging the arrows.

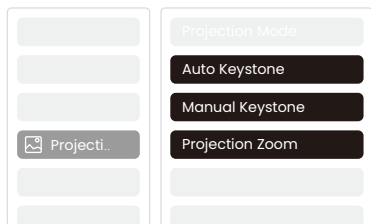

Auto Focus:

Auto focus will be activated after each shift.

You can also adjust the focus by clicking on the buttons on the remote control to get your desired picture.



Connectivity

Wi-Fi

If you are meet problems with network, please check your Wi-Fi signal via [Settings]-[Connected Wi-Fi]-[RSSI].



Screen Share

You can download the Yaber App from the Google Play Store or Apple App store for better screen casting!

NFC Settings

1. Download and install Yaber App by scanning QR code or searching “Yaber” on Apple App Store/Google Play Store
2. Make sure your phone and projector are connected to same Wi-Fi.
3. Tap your phone closely on the NFC area while the projector is powered on.

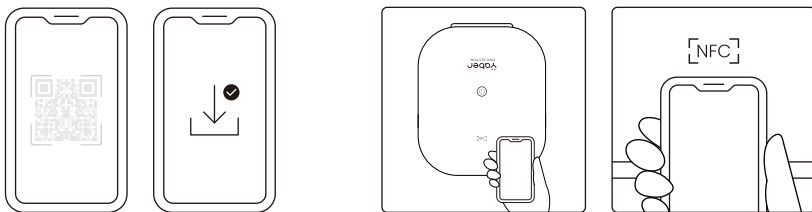

Bluetooth Speaker Mode

You can connect your phone to the projector via Bluetooth and enter Bluetooth audio mode anytime after confirmation.

In Bluetooth audio mode, you can also turn off the screen and turn the T2 into an outdoor stereo.

Notice: If another device is connecting to the projector's Bluetooth, please disconnect from it first, and then connect Bluetooth with the device you expect.

Quiet Mode

You can turn on Quiet Mode from the main page, which will provide you with a quieter and more subdued picture by reducing brightness and fan speed.



Important Precautions

Please use the device correctly:

- Do not face the lens into eyes because the strong projector light may cause injury to the eyes.
- Do not block the air inlet / outlet of the device to avoid damage to internal electronic devices arising from normal heat dissipation failure.
- Do not wipe the lens directly with cleaning tools including paper and cloth to avoid damage to the lens, please clean up the dust on the lens through clean air blowing.
- Do not wash the device with chemicals, detergents, or any liquid to prevent the circuit board from being corroded by rainwater, or moisture mineral-containing liquids.
- Keep the device's components and accessories out of reach of children.
- Make sure that the device is used in a dry and ventilated environment.
- Do not store the device in overheated or overcooled places, because extreme temperatures will shorten the life of electronic devices. Place and use the device in an environment of 0°C-40°C
- Do not put the device into any heating equipment (such as a dryer and microwave oven) for drying.
- Do not firmly extrude the device or place barriers on it or its back to avoid damage to the device.
- Do not throw, strike, or sharply vibrate the device to avoid damage to the internal circuit board
- Do not try to disassemble and assemble the device yourself. If any issue occurs, please contact the after sales service of Yaber.

Warranty

- DOLBY



Manufactured under license from Dolby Laboratories. Dolby, Dolby Audio, and the double-D symbol are trademarks of Dolby Laboratories Licensing Corporation.

- HDMI



The terms HDMI, HDMI High-Definition Multimedia Interface, HDMI trade dress and the HDMI Logos are trademarks or registered trademarks of HDMI Licensing Administrator, Inc.

FCC STATEMENT :

This device complies with Part 15 of the FCC Rules. Operation is subject to the following two conditions:

- (1) This device may not cause harmful interference, and
- (2) This device must accept any interference received, including interference that may cause undesired operation.

Warning: Changes or modifications not expressly approved by the party responsible for compliance could void the user's authority to operate the equipment.

NOTE: This equipment has been tested and found to comply with the limits for a Class B digital device, pursuant to Part 15 of the FCC Rules. These limits are designed to provide reasonable protection against harmful interference in a residential installation. This equipment generates uses and can radiate radio frequency energy and, if not installed and used in accordance with the instructions, may cause harmful interference to radio communications. However, there is no guarantee that interference will not occur in a particular installation. If this equipment does cause harmful interference to radio or television reception, which can be determined by turning the equipment off and on, the user is encouraged to try to correct the interference by one or more of the following measures:

Reorient or relocate the receiving antenna. Increase the separation between the equipment and receiver. Connect the equipment into an outlet on a circuit different from that to which the receiver is connected.

Consult the dealer or an experienced radio/TV technician for help.

FCC Radiation Exposure Statement:

This equipment complies with FCC radiation exposure limits set forth for an uncontrolled environment. This equipment should be installed and operated with minimum distance 20cm between the radiator & your body.



Correct Disposal of this product

This marking indicates that this product should not be disposed with other household wastes throughout the EU. To prevent possible harm to the environment or human health from uncontrolled waste disposal, recycle it responsibly to promote the sustainable reuse of material resources. To return your used device, please use the return and collection systems or contact the retailer where the product was purchased. They can take this product for environmental safe recycling.