

# Eaton Tripp Lite SmartOnline TAA Series

## Rack / Tower Advanced User's Guide

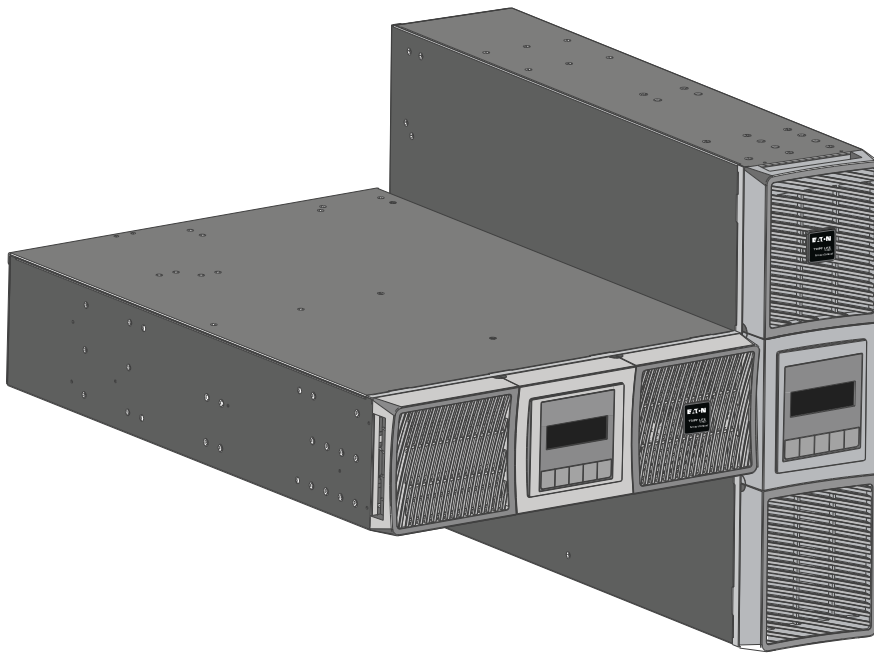

**SU6000RT3UTAA**  
**BP180RT3UTAA**

## Safety Instructions

SAVE THESE INSTRUCTIONS.

This manual contains important instructions **that should be followed during installation and maintenance of the UPS and batteries.**

This equipment has been tested and found to comply with the limits for a Class A digital device, pursuant to Part 15 of the FCC Rules. These limits are designed to provide reasonable protection against harmful interference when the equipment is operated in a commercial environment. This equipment generates, uses, and can radiate radio frequency energy and, if not installed and used in accordance with the instruction manual, may cause harmful interference to radio communications. Operation of this equipment in a residential area is likely to cause harmful interference in which case the user will be required to correct the interference at his own expense.

---

### **⚠ WARNING**

---

This is a category C2 UPS product. In a residential environment, this product may cause radio interference, in which case the user may be required to take additional measures.

---

## Suppliers Declaration of Conformity

Unique Identifier: EATON, SU6000RT3UTAA, BP180RT3UTAA

Responsible Party:

EATON  
10000 Woodward Ave  
Woodridge, IL 60517 USA  
773-869-1111  
[tripplite.eaton.com](http://tripplite.eaton.com)

## Special Symbols

The following are examples of symbols used on the product to alert you to important information:



**RISK OF ELECTRIC SHOCK** - Observe the warning associated with the risk of electric shock symbol.



**CAUTION: REFER TO OPERATOR'S MANUAL** - Refer to your operator's manual for additional information, such as important operating and maintenance instructions.



This symbol indicates that you should not discard the UPS or the UPS batteries in the trash. This product contains sealed, lead-acid batteries and must be disposed of properly. For more information, contact your local recycling/reuse or hazardous waste center.



This symbol indicates that you should not discard waste electrical or electronic equipment (WEEE) in the trash. For proper disposal, contact your local recycling/reuse or hazardous waste center.

## Battery Warning Instructions

- Risk of electric shock. All repairs and service should be performed by **AUTHORIZED SERVICE PERSONNEL ONLY**. There are **NO USER-SERVICEABLE PARTS** inside the UPS.
- Remove watches, rings, and other metal objects from the hands.
- Wear rubber gloves and boots.
- Use tools with insulated handles.
- The system must be properly grounded at all times.
- The battery supplied with the system contains small amounts of toxic materials. To avoid accidents, observe the following directives:
  - Servicing of batteries should be performed or supervised by personnel knowledgeable about batteries and the required precautions.
  - When replacing batteries, replace with the same type and number of batteries or battery packs.
  - Do not dispose of batteries in a fire. The batteries may explode.
  - Batteries constitute a danger (electrical shock and burning). The short-circuit current may be very high.
- Precautions must be taken for all handling. A battery can present a risk of electric shock and high short circuit current. The following precautions should be observed when working on batteries:
  - Do not lay tools or metal parts on top of batteries.
  - Disconnect the charging source prior to connecting or disconnecting battery terminals.
  - Remove battery grounds during installation and maintenance to reduce the likelihood of shock
  - Determine if the battery is inadvertently grounded. If inadvertently grounded, remove the source from the ground. Contact with any part of a grounded battery can result in electrical shock. The likelihood of such shock can be reduced if such grounds are removed during installation and maintenance (applicable to equipment and remote battery supplies not having a grounded supply circuit).

### **Product Safety**

- To connect the UPS, instructions and operation described in the manual must be followed in the indicated order.
- CAUTION - To reduce the risk of fire, the unit connects only to a circuit provided with 20 or 30 amperes maximum branch circuit over current protection in accordance with the National Electric Code.
- Check that the indications on the rating plate correspond to your AC powered system and to the actual electrical consumption of all the equipment to be connected to the system.
- Ensure that the system is free of any contaminants, the surrounding area is free of debris, and there are no foreign substances within the system.
- For PLUGGABLE EQUIPMENT, the socket-outlet shall be installed near the equipment and shall be easily accessible
- Do not allow any liquids to enter the UPS. Do not place beverages or any other liquid-containing vessels on or near the unit.
- This unit is intended for installation in a controlled environment (temperature-controlled, indoor area free of conductive contaminants). Avoid installing the UPS in locations with standing or running water or excessive humidity.
- Never install the system near liquids or in an excessively damp environment. This equipment should only be used in a dry, indoor environment.
- Never let a foreign body penetrate inside the system.
- Do not plug the UPS input into its own output.
- Never block the ventilation grates of the system.
- Never expose the system to direct sunlight or to a heat source.
- Store the system in a dry place before installing, if storage is required.
- Unplug the UPS prior to cleaning, and do not use liquid or spray detergent.
- The admissible storage temperature range is -25°C to +55°C without batteries, 0°C to 40°C with batteries.
- The system is not for use in a computer room AS DEFINED IN the standard for the Protection of Information Technology Equipment, ANSI/NFPA.
- To reduce the risk of overheating the UPS, do not cover the unit's cooling vents and avoid exposing the UPS to direct sunlight or installing the unit near heat-emitting appliances such as space heaters or furnaces.

### **Special Precautions**

- The unit is heavy: wear safety shoes and use vacuum lifter preferentially for handling operations.
- All handling operations will require at least two people (unpacking, lifting, installation in rack system).
- Before and after the installation, if the UPS remains de-energized for a long period, the UPS must be energized for a period of 24 hours, at least once every 6 months (for a normal storage temperature less than 25°C). This charges the battery, thus avoiding possible irreversible damage.
- For potential safety issue on defective UPS : DISCONNECT INTERNAL BATTERY for storage and transportation.

# Table of Contents

<b>1 Introduction</b> .....	<b>1</b>
1.1 Introduction.....	1
1.2 Environmental Protection .....	1
<b>2 Presentation</b> .....	<b>3</b>
2.1 Standard Installations .....	3
2.2 Accessories.....	3
2.3 Rear Panels .....	4
<b>3 Installation</b> .....	<b>5</b>
3.1 Inspecting the Equipment.....	5
3.2 Unpacking the Cabinet.....	5
3.3 Checking the Accessory Kit .....	6
3.4 Tower Installation .....	7
3.5 Rack Installation .....	8
3.6 Connecting the Internal Battery .....	9
3.7 Installation Requirements.....	10
3.8 Connecting the EBM's.....	11
3.9 Connecting the Power Cables .....	12
3.10 Detecting Other Accessories.....	12
<b>4 Interfaces and Communication</b> .....	<b>13</b>
4.1 Control Panel .....	13
4.2 LCD Description .....	14
4.3 UPS Home Menu .....	15
4.4 User Settings.....	16
4.5 Communication Ports .....	18
4.6 UPS Remote Control Functions .....	19
4.7 Tripp Lite by Eaton PowerAlert Software Suite.....	21
<b>5 Operation</b> .....	<b>22</b>
5.1 Startup and Normal Operation .....	22
5.2 Starting the UPS on Battery .....	22
5.3 UPS Shutdown .....	22
<b>6 Modes of Operation</b> .....	<b>23</b>
6.1 Online Mode .....	23
6.2 Battery Mode .....	23
6.3 Low Battery Warning.....	23
6.4 Bypass Mode .....	23
6.5 Standby Mode .....	23
6.6 Transferring Between Modes.....	24



# Table of Contents

6.7 Setting High-Efficiency mode .....	24
6.8 Configuring Battery Settings .....	24
6.9 Retrieving the Event Log .....	24
<b>7 UPS Maintenance.....</b>	<b>25</b>
7.1 Equipment Care .....	25
7.2 Storing the Equipment .....	25
7.3 Replacing the Batteries .....	25
7.4 Recycling The Used Equipment .....	27
<b>8 Troubleshooting .....</b>	<b>28</b>
8.1 Typical Alarms and Faults .....	28
8.2 Silencing the Alarm .....	29
8.3 Service and Support .....	30
<b>9 Specifications.....</b>	<b>31</b>
9.1 Model Specifications .....	31



# Chapter 1 Introduction

## 1.1 Introduction

Thank you for selecting an Eaton Tripp Lite Series product to protect your electrical equipment. The Eaton Tripp Lite Series SmartOnline UPS range has been designed with the utmost care. Please take the time to read the safety instructions and the advanced user guide to take full advantage of the many features of your Uninterruptible Power System.

To discover the entire range of products and the options available for the Tripp Lite by Eaton SmartOnline UPS range, visit our website at [tripplite.eaton.com](http://tripplite.eaton.com) or contact your Eaton Tripp Lite Series representative.

## 1.2 Environmental Protection

Eaton has implemented an environmental-protection policy.

Products are developed according to an eco-design approach.

### Substances

This product does not contain CFCs, HCFCs, or asbestos.

### Packing

To improve waste treatment and facilitate recycling, separate the various packing components.

- The cardboard we use comprises over 50% of recycled cardboard.
- All bags are made of polyethylene.
- Packing materials are recyclable and bear the appropriate identification symbol



**Table 1. Packing Material Symbols**

Materials	Abbreviations	Number in the symbols
Polyethylene terephthalate	PET	01
High-density polyethylene	HDPE	02
Polyvinyl chloride	PVC	03
Low-density polyethylene	LDPE	04
Polypropylene	PP	05
Polystyrene	PS	06

Follow all local regulations for the disposal of packing materials.

### End of Life

Eaton will process products at the end of their service life in compliance with local regulations. Eaton works with companies in charge of collecting and eliminating our products at the end of their service life.



### **Product**

The product is made up of recyclable materials.

Dismantling and destruction must take place in compliance with all local regulations concerning waste. At the end of its service life, the product must be transported to a processing center for electrical and electronic waste.

### **Battery**

The product contains lead acid (Pb) batteries that must be processed according to applicable local regulations concerning batteries.

The battery may have to be removed to comply with regulations and in view of the correct local disposal requirements.

### **Benefits**

The Eaton Tripp Lite Series UPS protects your sensitive electronic equipment from the most common power problems, including power failures, power sags, power surges, brownouts, line noise, high voltage spikes, frequency variations, switching transients, and harmonic distortion.

Power outages can occur when you least expect it, and power quality can be erratic. These power problems have the potential to corrupt critical data, destroy unsaved work sessions, and damage hardware, causing hours of lost productivity and expensive repairs.

With the Eaton Tripp Lite Series SmartOnline UPS, you can safely eliminate the effects of power disturbances and guard the integrity of your equipment. Providing outstanding performance and reliability and unique benefits that include the following:

- True online double-conversion technology with high power density, utility frequency independence, and generator compatibility.
- Selectable High-Efficiency mode of operation.
- Standard communication options: one RS-232 communication port, USB communication port, and relay output contacts.
- Optional connectivity cards with enhanced communication capabilities.
- Extended runtime with up to four Extended Battery Modules (EBMs) per UPS.
- Remote On/Off control through Remote On/Off (ROO) and Remote Power Off (RPO) ports.
- Backed by worldwide agency certifications.

## Chapter 2 Presentation

### 2.1 Standard Installations

Figure 1. UPS Dimensions

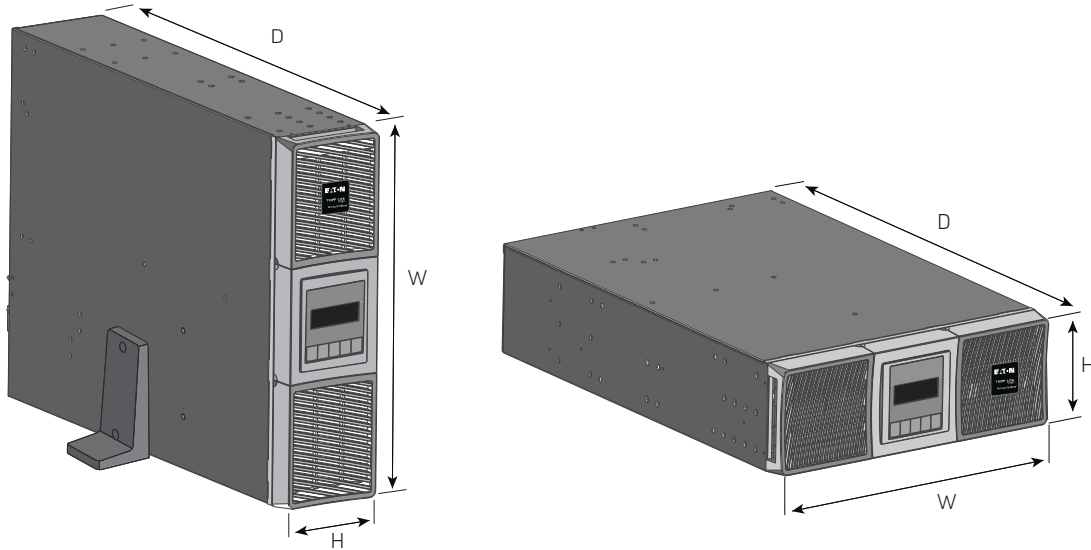

Description	Weights (lb/kg)	Dimensions (inch/mm) D xW xH
SU6000RT3UTAA	106 / 48	28.4 x 17.3 x 5.1 / 722 x 440 x 130
BP180RT3UTAA	150 / 68	25.4 x 17.3 x 5.1 / 645 x 440 x 130

### 2.2 Accessories

Table 2. UPS Accessories

Part number	Description
BP180RT3UTAA	Extended battery module
SUTFMR	5K transformer module
SUPDMBP6K	SmartOnline maintenance bypass module
RK2PC	Two-post rail kit
LXE communication card	Network card
RELAY-MS	Relay card

### 2.3 Rear Panels

**Figure 2. SU6000RT3UTAA**

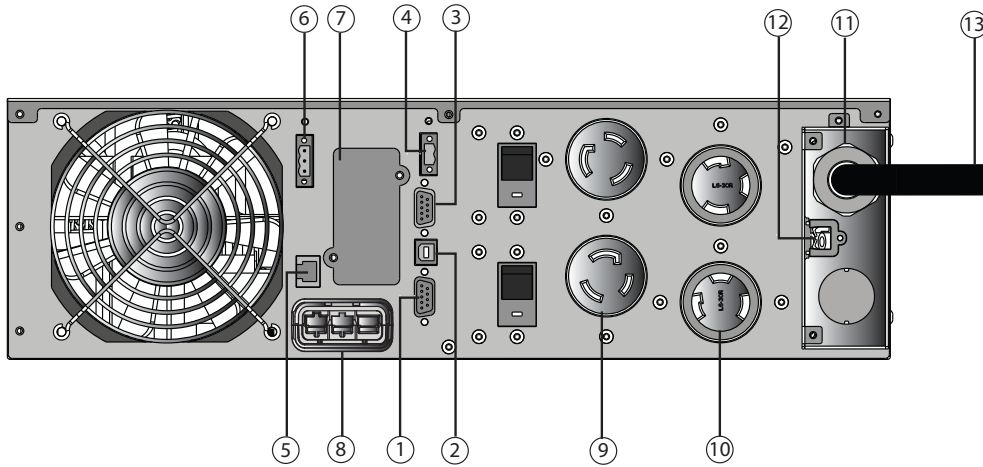

- |  |   |
|--|---|
| <ul style="list-style-type: none"> <li>① RS232 communication port</li> <li>② USB communication port</li> <li>③ Dry (relay)contacts communication port</li> <li>④ Connector for ROO (Remote On / Off) control</li> <li>⑤ Connector for communicating with an additional battery module</li> <li>⑥ Connector for RPO (Remote Power Off) control</li> </ul> | <ul style="list-style-type: none"> <li>⑦ Slot for optional communication card</li> <li>⑧ Connector for additional battery module</li> <li>⑨ (2) L6-20R outlets</li> <li>⑩ (2) L6-30R outlets</li> <li>⑪ Input / Output terminal blocks</li> <li>⑫ Connector for Hotswap / MBP detection</li> <li>⑬ Input power cable with L6-30 plug</li> </ul> |
|--|---|

**Figure 3. BP180RT3UTAA**

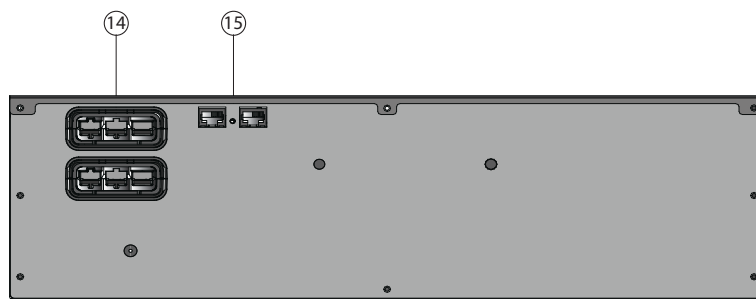

- |   |  |
|---|--|
| <ul style="list-style-type: none"> <li>⑭ Connectors for battery modules (to the UPS or to the other battery modules)</li> </ul> | <ul style="list-style-type: none"> <li>⑮ Connectors for communicating with an additional battery module</li> </ul> |
|---|--|



## Chapter 3 Installation

### 3.1 Inspecting the Equipment

If your equipment has been damaged during shipment, keep the shipping cartons and packing materials for the carrier or place of purchase and file a claim for shipping damage. If you discover damage after acceptance, file a claim for concealed damage.

To file a claim for shipping damage or concealed damage:

1. File with the carrier within 15 days of receipt of the equipment;
2. Send your Eaton Tripp Lite Series service representative a copy of the damage claim within 15 days.



#### IMPORTANT

---

Check the battery recharge date on the shipping carton label. If the date has passed and the batteries were never recharged, do not use the UPS. Contact your service representative.

---

### 3.2 Unpacking the Cabinet

Unpacking the UPS in a low-temperature environment may cause condensation in and on the UPS cabinet. Do not install the UPS until the inside and outside of the UPS are dry (hazard of electric shock).

The cabinet is heavy. Follow the special precautions provided and on the carton.

Unpack the equipment and remove all the packing materials and shipping carton.



#### NOTE

Do not lift the UPS or EBM from the front panel.

---

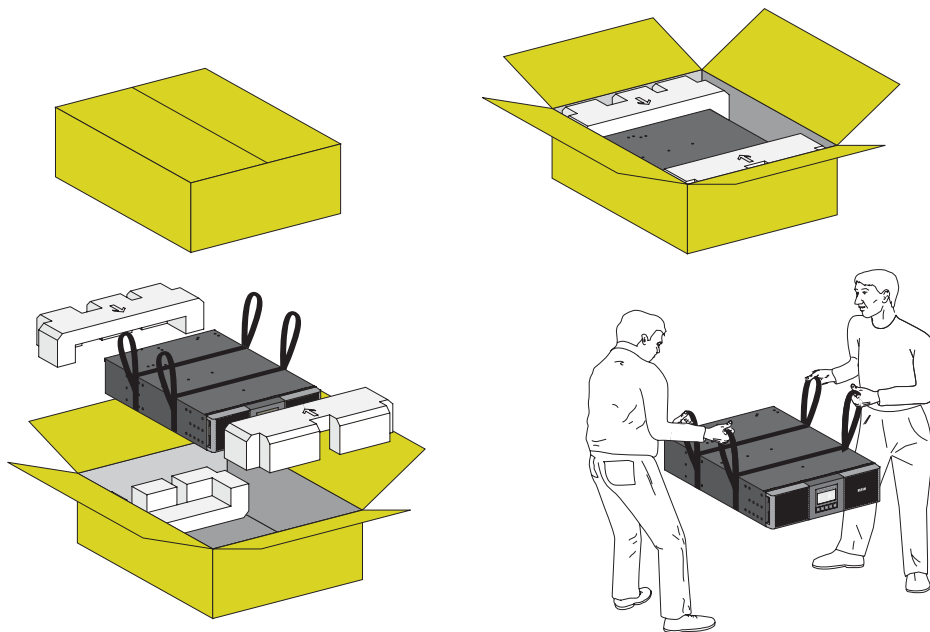

Discard or recycle the packaging responsibly, or store it for future use. Place the cabinet in a protected area with adequate airflow free of humidity, flammable gas, and corrosion.

## Checking the Accessory Kit

Packing materials must be disposed of in compliance with all local regulations concerning waste. Recycling symbols are printed on the packing materials to facilitate sorting.

### 3.3 Checking the Accessory Kit

Verify that the following additional items are included with the UPS:

**Figure 4. SU6000RT3UTAA**

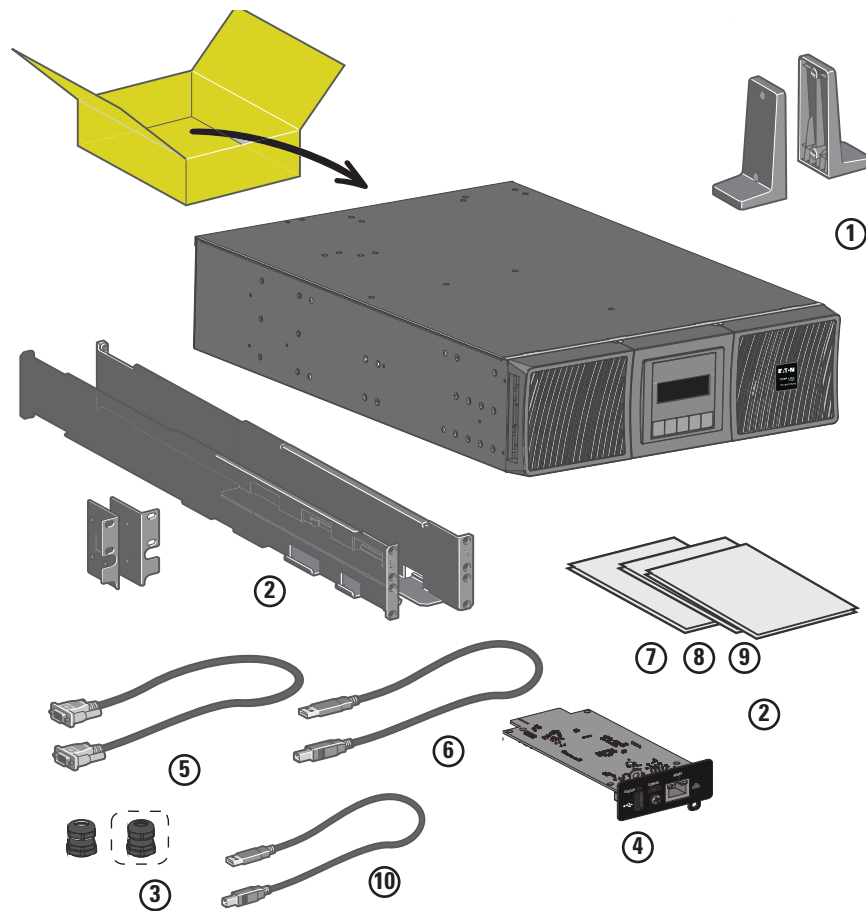

- ① (2) Tower stands
- ② Rack kit for 19-inch enclosures
- ③ Cable gland for output connection  
additional cable gland for Input
- ④ LXE communication card (optional)  
standard on network bundle models
- ⑤ RS232 communication cable
- ⑥ USB communication cable
- ⑦ Safety instructions
- ⑧ Quick start guide
- ⑨ LXE card user guide
- ⑩ LXE card data cable

Figure 5. BP180RT3UTAA

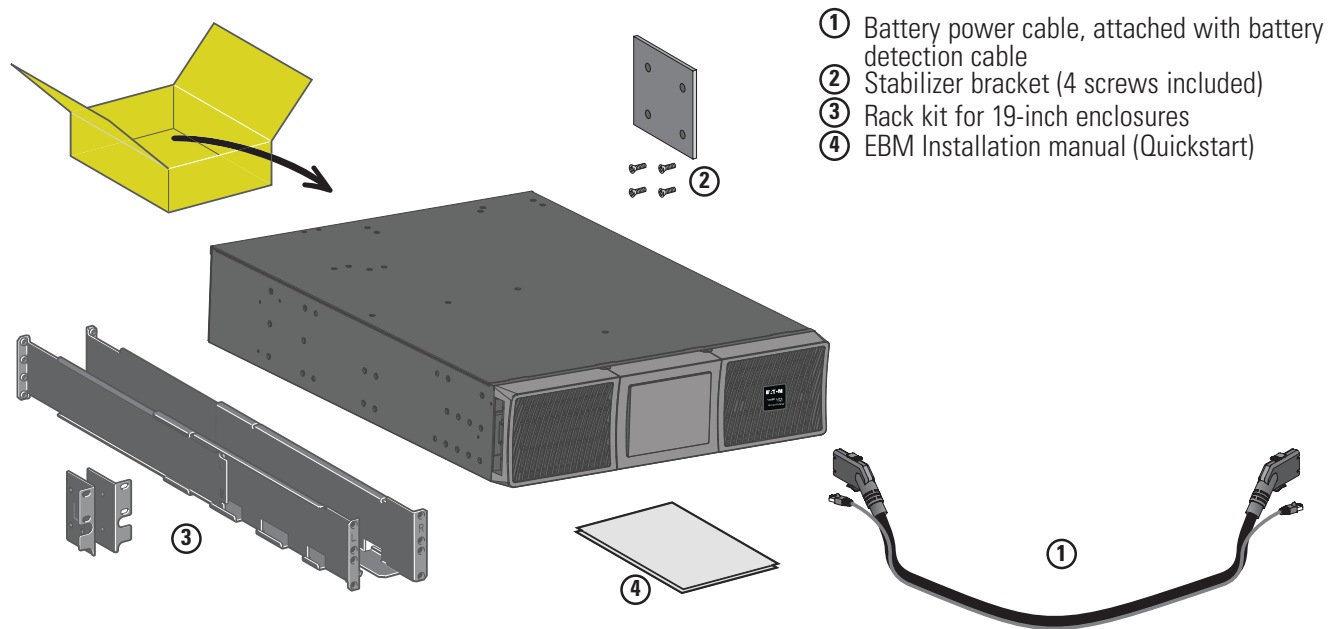

**NOTE 1** Discard the EBM user's guide if you are installing the EBM with a new UPS at the same time.

**NOTE 2** Use the UPS user's guide to install the UPS and the EBM.

**NOTE 3** If you ordered other UPS accessories, refer to specific user manuals to check the packing contents.

### 3.4 Tower Installation

**Tip** If you ordered other UPS accessories, refer to specific user manuals to check the tower installation with the UPS. The UPS batteries come from the factory disconnected; see [Figure 6](#) to connect the battery pack.

To install the cabinet:

1. Place the UPS on a flat, stable surface in its final location.
2. Always keep six inches or 150 mm of free space behind the UPS rear panel for ventilation.
3. If installing additional cabinets, place them next to the UPS in their final location.

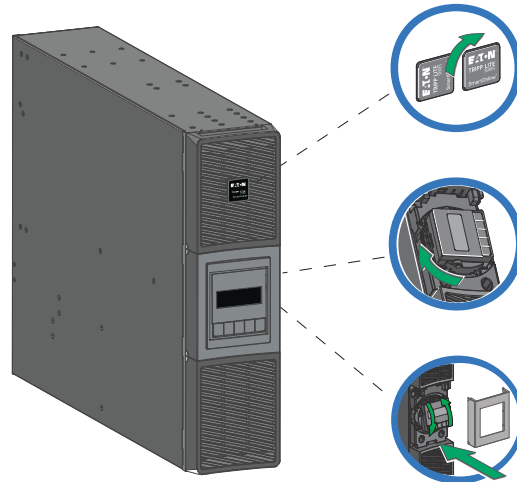
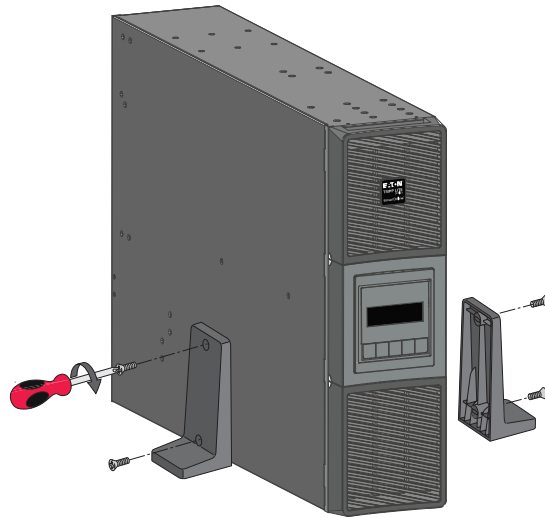

## 3.5 Rack Installation

---

**i NOTE** It is remove the UPS internal battery pack before attempting to install the UPS in a rack. See [Figure 13](#) for instructions on how to remove the battery pack.

---

Follow steps 1 to 5 to mount the UPS onto the rails.

---

**i NOTE** Eaton supplies the rack mounting rails and necessary hardware.

---

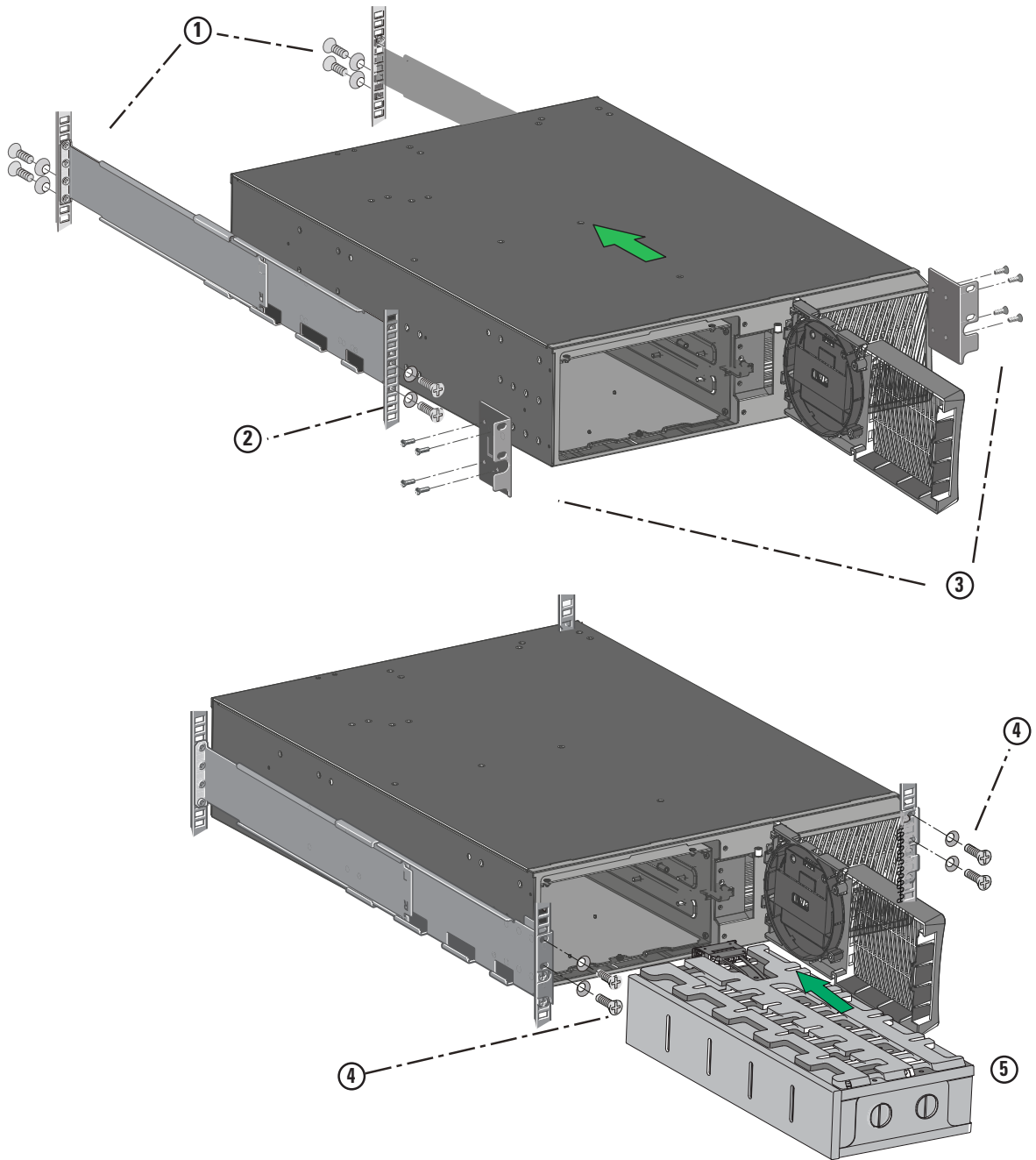

### 3.6 Connecting the Internal Battery



**NOTE**

Only connect the UPS to the utility once the installation is complete. Do not make unauthorized changes to the UPS; otherwise, damage may occur to your equipment and void your warranty.



**Figure 6. Internal Battery Connection**

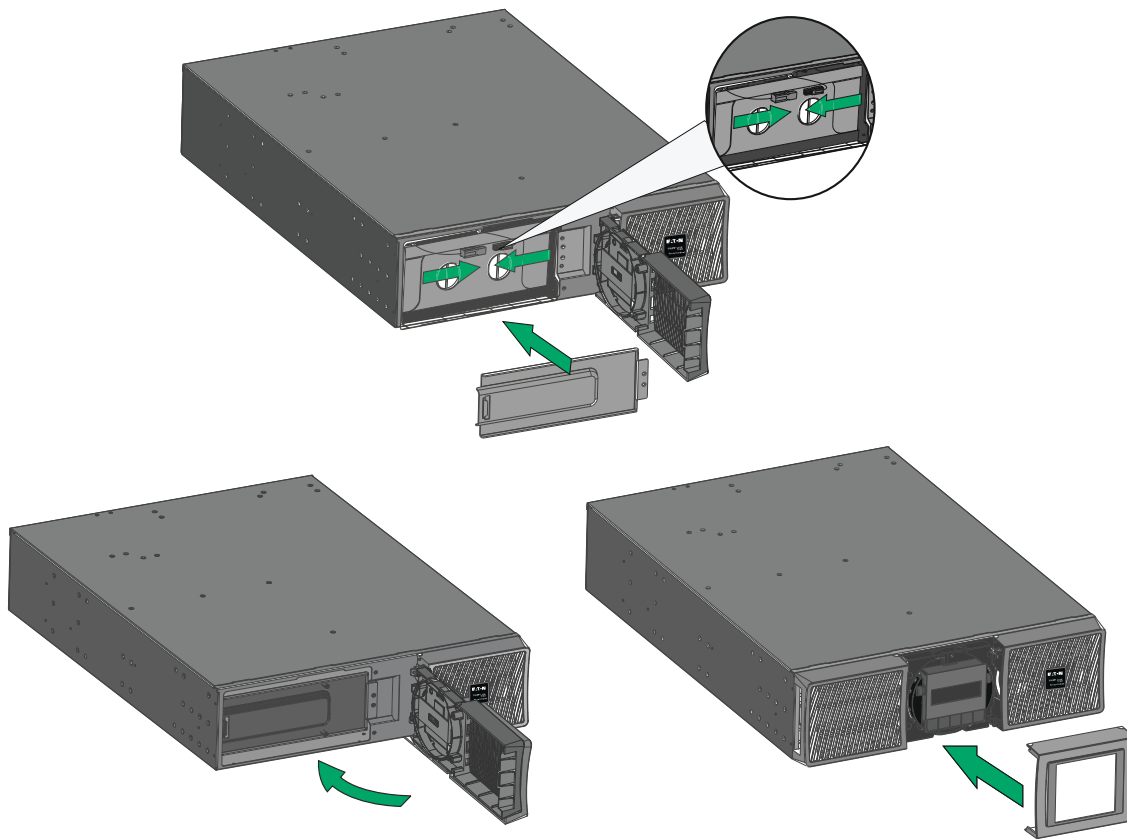

To connect to the UPS internal battery pack:

1. Connect the two battery connectors.
2. Reinstall the battery protection cover and the front panel, then clip the center cover.

### 3.7 Installation Requirements

Eaton recommends the following protective devices and cable cross-sections.

**Table 3. Upstream protection**

UPS Power rating	Upstream circuit breaker
6000VA	D curve — 30A

**Table 4. Recommended wire size**

Terminal Position	Wire Function	Terminal Wire Size Rating	Minimum Input Wire Size	Tightening Torque
L1	Phase	4-16 mm <sup>2</sup> (12-6 AWG)	6 mm <sup>2</sup> (10 AWG) 105° C 10 mm <sup>2</sup> (8 AWG) 75°C	10 lb in / 1.13 Nm

**Table 4. Recommended wire size (Continued)**

Terminal Position	Wire Function	Terminal Wire Size Rating	Minimum Input Wire Size	Tightening Torque
N (L2)	Neutral (Phase)			
	Ground			

### 3.8 Connecting the EBM's

#### **CAUTION**

To ensure a proper connection, insert the EBM cable into the battery connector quickly and firmly so that the battery cable will not come loose or pull away.

1. Plug the EBM power cable(s) into the battery connector(s). Up to four EBM's may be connected to the UPS.
2. Verify that the EBM connections are tight and that each cable has adequate bend radius and strain relief.
3. Connect the battery detection cable(s) to the UPS connector and the EBM(s).

**Figure 7. SmartOnline Rack / Tower EBM Connections**

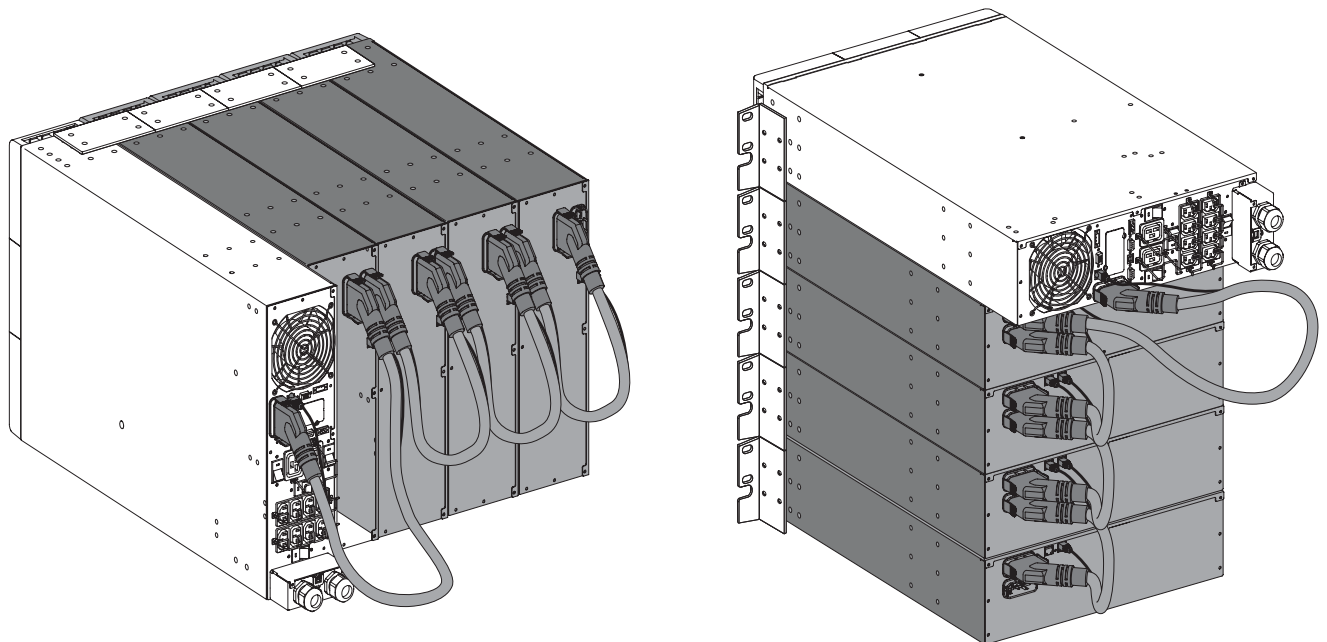

### 3.9 Connecting the Power Cables

#### Access to Terminal Blocks

1. Remove the terminal blocks cover (one screw)
2. Punch out the knockouts and insert the cables/conduits inside.

**CAUTION**

High leakage current. Earth connection essential before connecting supply.

**NOTE** The L6-30P input power cable is attached by Eaton.

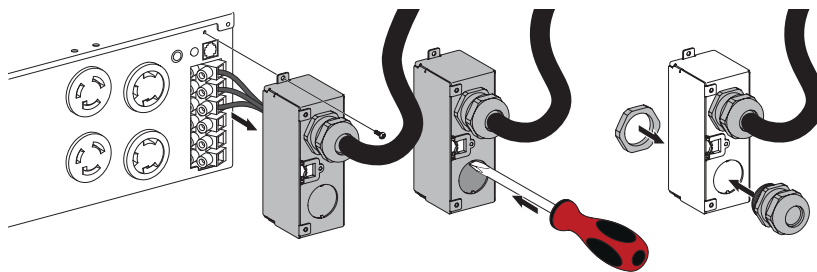

**WARNING**

This type of connection must be carried out by qualified electrical personnel.

Before carrying out any connection, check that the upstream protection device (Normal AC source) is open "O" (Off). Always connect the ground wire first.

If you ordered additional equipment, refer to the specific user manual to check the terminal blocks connection of the UPS with this accessory.

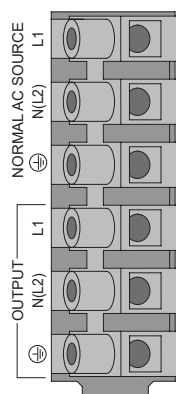

- 1 Insert the Normal AC cable through the cable gland.
- 2 Connect the three cables to the Normal AC source terminal blocks.
- 3 Insert the Output cable through the cable gland.
- 4 Connect the three cables to the Output terminal blocks.
- 5 Put back and secure the terminal blocks cover with the screw.
- 6 Tighten the strain relief.

### 3.10 Detecting Other Accessories

**Tip** If you ordered other UPS accessories, refer to their specific user manuals to check the connection to the UPS.





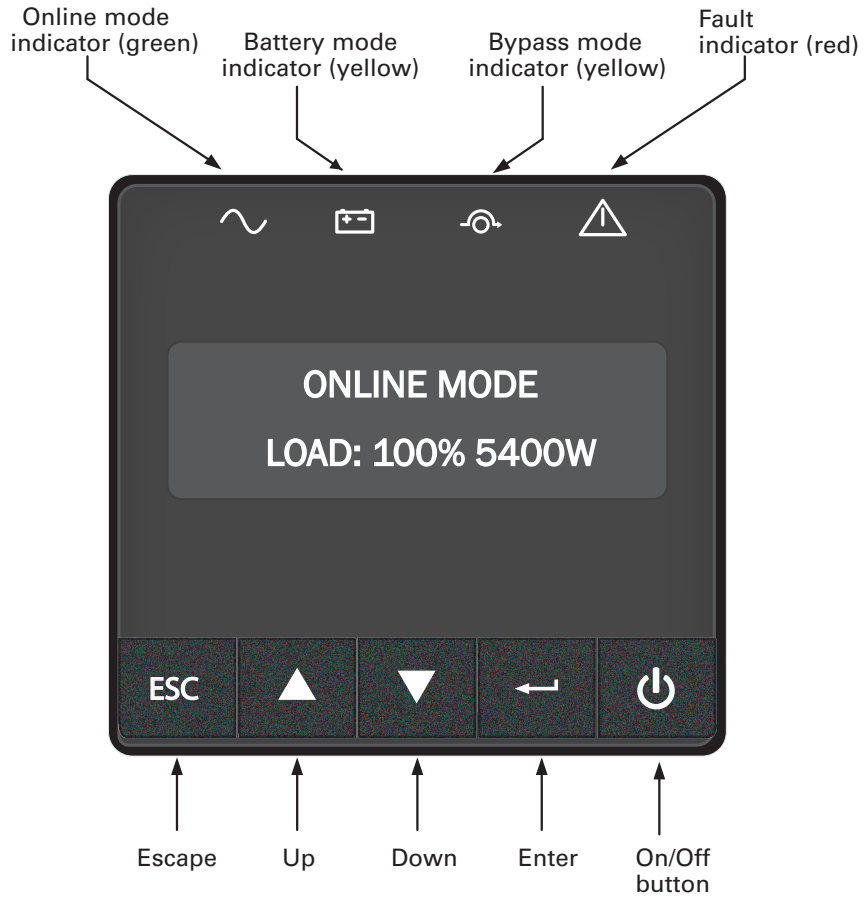

## Chapter 4 Interfaces and Communication

### 4.1 Control Panel

Figure 8. Control Panel



Indicator	Status	Description
 Green	On	The UPS is operating normally on Online, on High-Efficiency mode or on Battery Mode.
 Orange	On	The UPS is on Battery Mode.
 Orange	On	The UPS is on Bypass Mode.
 Red	On	The UPS has an active alarm or fault.

## 4.2 LCD Description

The LCD screen has two lines, and each line has 16 characters. The first line shows the UPS status and the second line shows the UPS measurements.

After five minutes of inactivity, the LCD displays the screen saver, and the LCD backlight automatically dims. Press any button to restore the screen.

Note: If a fault or alarm appears, the first line of LCD will cycle between the fault/alarm message and UPS mode. See [8.1 Typical Alarms and Faults](#) for additional information.

**Figure 9. LCD Description**

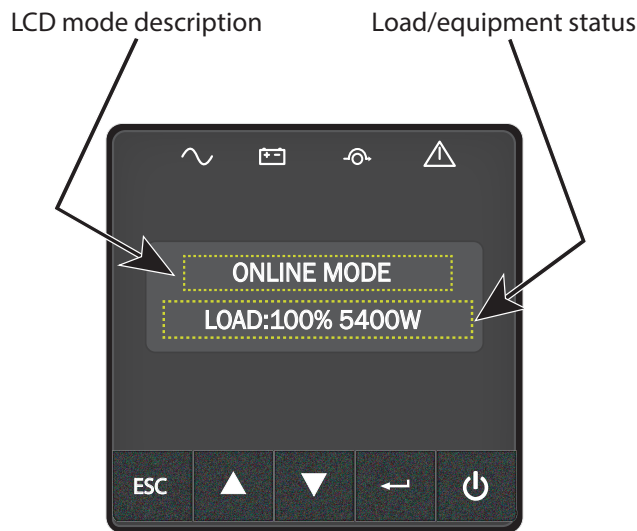

The following table describes the status information provided by the UPS

**Note:** If any other indicator displays, see [8.1 Typical Alarms and Faults](#) for additional information.

**Table 5. LCD Operating Modes**

UPS Display	Description
<p>STANDBY MODE IN : 208V 60.0HZ</p>	<p>Equipment is not powered until  button is pressed. The UPS is Off, waiting for the startup command from user.</p>
<p>ONLINE MODE LOAD:100% 5400VA</p>	<p>The UPS is powering and protecting the equipment. The UPS is operating normally.</p>
<p>BATTERY MODE RUNTIME : 104MIN</p>	<p>A utility failure has occurred and the UPS is on Battery Mode. The UPS is powering the equipment with the battery power. Prepare your equipment for shutdown.</p>

**Table 5. LCD Operating Modes (Continued)**

UPS Display	Description
<p><b>HIGH EFFIC. MODE</b> IN : 208V 60.0HZ</p>	The UPS is operating on High-Efficiency mode. The UPS is powering and protecting the equipment
<p><b>BYPASS MODE</b> IN : 208V 60.0HZ</p>	An overload or a fault has occurred, or a command has been received, and the UPS is in Bypass Mode. Equipment is powered but not protected by the UPS.

### 4.3 UPS Home Menu

The SmartOnline UPS will display the *Home Menu* by default. The *Home Menu* will show the UPS mode and contains nine different types of UPS measurements that can be seen by navigating the menu.

Navigate the *Home Menu* by pressing the ▲ or ▼ buttons on the display.

Press the ESC button to return to the first measurement of the *Home Menu*.

**Table 6. UPS Home Menu**

Display Information	LCD Display	Bottom Row Values
Displays the UPS mode, load percentage and W.	<p><b>ONLINE MODE</b> LOAD : 100% 4500W</p>	The LOAD DATA screen specifies the amount of power that connected equipment is currently using in terms of percentage and Watts.
Displays the UPS mode, load percentage and VA.	<p><b>ONLINE MODE</b> LOAD:100% 5400VA</p>	The OUTPUT LOAD LEVEL screen indicates the load percentage and VA output load level.
Displays the UPS mode and output load power factor.	<p><b>ONLINE MODE</b> LOAD: PF = 0.99</p>	The OUTPUT LOAD POWER FACTOR screen indicates the power factor of connected equipment.
Displays the UPS mode, input voltage and frequency.	<p><b>ONLINE MODE</b> IN:208V 60.0HZ</p>	The INPUT VOLTAGE & FREQUENCY screen displays current UPS input data.
Displays the UPS mode, bypass voltage and frequency	<p><b>ONLINE MODE</b> BP : 208V 60.0HZ</p>	The BYPASS VOLTAGE & FREQUENCY screen displays current data.
Displays the UPS mode and output voltage and frequency.	<p><b>ONLINE MODE</b> OUT : 208V 60.0HZ</p>	The OUTPUT VOLTAGE & FREQUENCY screen displays current UPS output data.

**Table 6. UPS Home Menu (Continued)**

Display Information	LCD Display	Bottom Row Values
Displays the UPS mode, battery voltage and battery charge percentage.	<b>ONLINE MODE</b> <b>BATT : 180V 100%</b>	The BATTERY VOLTAGE screen tracks the charge level of your connected battery bank in terms of voltage and charge percentage.
Displays the UPS mode, and remaining battery runtime.	<b>ONLINE MODE</b> <b>RUNTIME : 104MIN</b>	The RUNTIME REMAINING screen tracks the approximate minutes of runtime available under the current loading and battery pack configuration. The runtime value will automatically re-calculate as connected equipment power consumption changes.
Displays the UPS mode, and external battery quantity.	<b>ONLINE MODE</b> <b>EBM: X</b>	The EBM screen display external battery quantity.
Displays the UPS mode, and remaining Watts of UPS.	<b>ONLINE MODE</b> <b>REMAIN W: 2.20KW</b>	The REMAIN WATTS screen tracks the remaining capacity of the UPS in kilowatt.
Displays the UPS mode and cumulative demand energy by the UPS.	<b>ONLINE MODE</b> <b>DEMAND E: 2.20KWH</b>	The DEMAND ENERGY screen offers continuous data on the KWh (kilowatt-hour) that connected equipment has consumed in the last one-hour period.

#### 4.4 User Settings

The following table displays the options that can be changed by the user.

**Table 7. User Settings**

	Submenu	Available Settings	Default settings
Local Settings	Language	[English] [Français] [Deutsch] [Español] [Русский] [Português] [Italiano] [Simplified Chinese] [Japanese] Menus, status, notices and alarms, UPS fault, Event Log data and settings are in all supported languages.	[English] User selectable when UPS is powered for the first time.
	Date/ time	Format: [International] [US]	[US]
	LCD	Modify LCD screen brightness and contrast to be adapted to room light conditions.	
	Audible alarm	Mode: [Enabled] [Disabled on battery] [Always disabled] Enable or disable the buzzer if an alarm occurs. Level: [High] [Low]	[Enabled] [High]
In/Out settings	Output voltage	[200V] [208V] [220V] [230V] [240V]	[208V]
	Output frequency	Frequency converter: [Enabled] [Disabled] Frequency settable in frequency converter mode	[Disabled]



Table 7. User Settings (Continued)

	Submenu	Available Settings	Default settings
	Output mode	[Industrial] [Network] Set UPS behavior regarding transfer on Bypass	[Network]
	Input volt hysteresis	Sets input voltage hysteresis from [1] to [10V]	[10V]
	High Efficiency mode	[Enabled] [Disabled] Power the output from Bypass for high efficiency	[Disabled]
	Bypass transfer	[Transfer if BP AC NOK] [Enabled] [Disabled] Allow transfer on Bypass out of tolerance	[Disabled]
	Interrupt time	If Bypass transfer is enabled, Interrupt time: [10ms] [20ms] Define break duration when transfer on Bypass	[10ms]
	Overload prealarm	[10%] ... [102%] Load % when overload alarm occurs	[102%]
	Redundancy mode	[Unitary UPS] [Hot Standby] Force slew rate value to 0.5Hz/s	Unitary UPS
On/Off Settings	Cold Start	[Enabled] [Disabled] Authorize the product to start on battery power.	[Enabled]
	Forced reboot	[Enabled] [Disabled] If mains recover during a shutdown sequence: If set to Enabled, shutdown sequence will complete and wait 10 seconds prior to restart, If set to Disabled, shutdown sequence will not complete and restart will occur immediately.	[Enabled]
	Auto restart	[Enabled] [Disabled] Authorize the product to restart automatically when mains recovers after a complete battery discharge.	[Enabled]
	Auto start	[Enabled] [Disabled] The UPS automatically starts up as soon as mains power is available (no need to press the  button).	[Disabled]
	Energy Saving	[Disabled] [100W] ... [1000W] If Enabled, UPS will shutdown after 5 min. of back-up time, if load is less than threshold.	[Disabled]
	Sleep mode	[Enabled] [Disabled] If Disabled, LCD and communication will turn OFF immediately after UPS is OFF. If Enabled, LCD and communication stays ON 1h30 min after UPS is OFF.	[Enabled]
	Remote Command	[Enabled] [Disabled] If Enabled, shutdown or restart commands from software are authorized.	[Enabled]

**Table 7. User Settings (Continued)**

	Submenu	Available Settings	Default settings
	Bypass standby	[Enabled] [Disabled] Define if output is powered from Bypass in Standby mode.	[Disabled]
Battery settings	Low battery warning	[Capacity] [0%] ... [100%] The alarm triggers when the set percentage of battery capacity or remaining back-up time is reached.	[20%]
	Restart bat. level	[0%] ... [100%] If set, automatic restart will occur only when percentage of battery charge is reached.	[0%]
	External battery	[Auto detection] [Manual EBM set.] [Manual battery set.] [No battery]	[Auto detection] Using standard EBM, UPS detects automatically the number of EBM connected
	Deep Disch. protect.	[Yes] [No] If set to Yes, the UPS automatically prevents battery from deep discharge by adapting end of back-up time voltage threshold. Warranty void if set to No.	[Yes]

## 4.5 Communication Ports

**Figure 10. Communication Port Information**

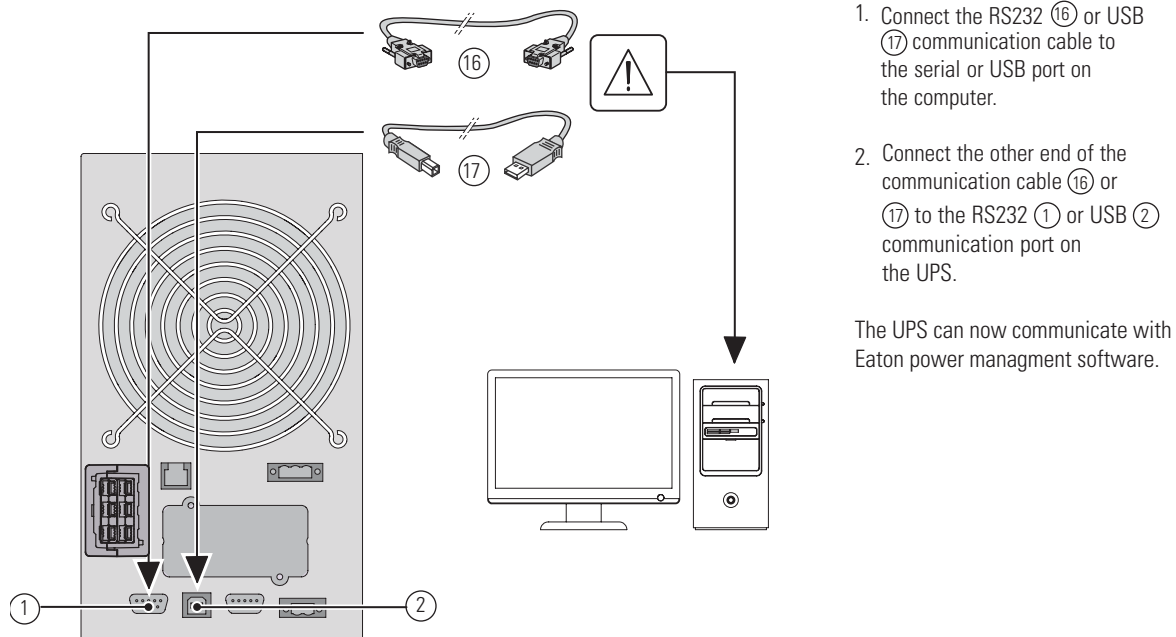

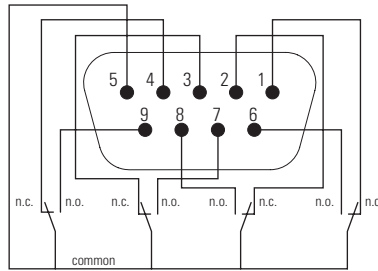

**Table 8. Communication Port Pinouts**

Pin 1: not on bypass	Pin 6: on bypass
Pin 2: load not protected	Pin 7: low battery
Pin 3: not low battery	Pin 8: load protected
Pin 4: not on battery	Pin 9: on battery
Pin 5: user common	
n.o.: contact normally open n.c.: contact normally closed	



**IMPORTANT**



The relay output contacts must not be connected to any utility-connected circuits. Reinforced insulation to the utility is required. The relay output contacts have a maximum rating of 250 Vac/5A.

## 4.6 UPS Remote Control Functions

### Remote On/Off

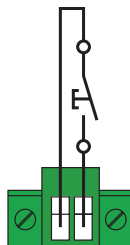
**Figure 11. Normally Open ROO**



- Remote On/Off allows for remote activation of the  button to switch the UPS On/Off.
- When contact changes from open to closed, the UPS is switched on (or stays on).
- When contact changes from closed to open, the UPS is switched off (or stays off).
- On/off control via the  button has priority over the remote control.



## Remote Power Off

RPO is used to shut down the UPS remotely when the contact is open. This feature can be used for shutting down the load and the UPS by thermal relay, for instance, in the event of room over temperature. When RPO is activated, the UPS shuts down the output and all of its power converters immediately. The UPS remains on to alarm the fault. The RPO circuit is an IEC 60950 safety extra low voltage (SELV). This circuit must be separated from any hazardous voltage circuits by reinforced insulation.

- The RPO must not be connected to any utility-connected circuits. Reinforced insulation to the utility is required. The RPO switch must have a minimum rating of 27 Vdc and 20 mA and be a dedicated latching type switch not tied into any other circuit. For proper operation, the RPO signal must remain active for at least 250 ms.
- To ensure the UPS stops supplying power to the load during any mode of operation, the input power must be disconnected from the UPS when the Remote Power Off function is activated.

Leave the RPO connector installed in the RPO port on the UPS even if the RPO function is not utilized.

### RPO Connections:

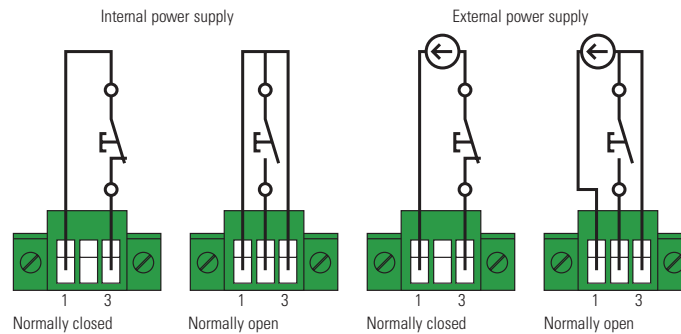

Terminal wire size rating is 0.32-4 mm<sup>2</sup> (22-12 AWG).  
Suggested wire size is 0.82 mm<sup>2</sup> (18 AWG).

### Remote control connection and test

1. Verify that the UPS is shut down and that the mains electrical input is disconnected from the UPS.
2. Remove the RPO connector from the UPS by loosening the screws.
3. Connect a normally closed volt-free contact between the two pins of the connector.

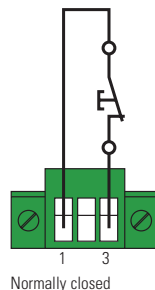

Contact open: shut down of UPS  
To return to normal operation, deactivate the external remote shut down contact and restart the UPS from the front panel.

4. Plug the RPO connector into the back of the UPS and tighten the screws.
5. Connect and restart the UPS according to the previously-described procedures.

6. Activate the external remote shutdown contact to test the function. Always test the RPO function before applying your critical load to avoid an accidental load loss.

### Connectivity Cards

Connectivity cards allow the UPS to communicate in a variety of networking environments and with different types of devices. The SmartOnline models have one open communication bay for the WEBCARDLXE network card, which provides monitoring and control using an SNMP network management platform, web browser, SSH, or Telnet.

**Figure 12. WEBCARDLXE**

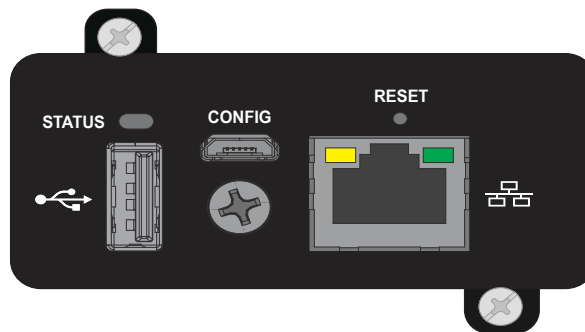

**NOTE**

Connect a Cat-6 shielded ethernet cable (F/UTP or F/FTP) or higher between the LXE platform device's ethernet port and a network jack.

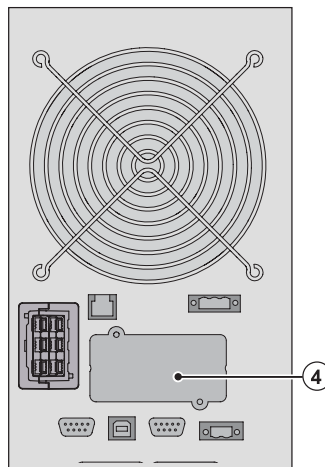

It is not necessary to shutdown the UPS before installing a communication card.

1. Remove the slot cover ④ secured by screws.
2. Insert the communication card in the slot.
3. Secure the card cover with the 2 screws.

## 4.7 Tripp Lite by Eaton PowerAlert Software Suite

The Tripp Lite by Eaton PowerAlert software suite is available from [www.tripplite.eaton.com](http://www.tripplite.eaton.com). The PowerAlert software suite provides up-to-date graphics representing UPS power and system data and power flow. It also gives you a complete record of critical power events and notifies you of important UPS or power information.

In the case of a power outage, or the SmartOnline UPS battery power becomes low, the PowerAlert Software suite can automatically shut down your computer system to protect your data before the UPS shutdown occurs.





## Chapter 5 Operation

### 5.1 Startup and Normal Operation

**NOTE**

If you ordered a transformer module or other accessory, refer to the specific user manual of that accessory to check the startup sequence of the UPS with the accessory.

To start the UPS:

1. Verify that the internal batteries are connected. See [3.6 Connecting the Internal Battery](#).
2. If optional EBMs are installed, verify that the EBMs are connected to the UPS. See section [3.8 Connecting the EBM's](#).
3. Verify that the UPS power cord is plugged in.
4. The UPS front panel display will illuminate.
5. Press the  button on the UPS front panel for at least 3 seconds. The UPS front panel display changes status to "UPS starting...".
6. Check the UPS front panel display for active alarms or notices. Resolve any active alarms before continuing. See section [8.1 Typical Alarms and Faults](#). If the  indicator is on, do not proceed until all alarms are clear. Check the UPS status from the front panel to view the active alarms. Correct the alarms and restart if necessary.
7. Verify that the  indicator illuminates solid green, indicating that the UPS is operating normally and any loads are powered and protected.

### 5.2 Starting the UPS on Battery

Before using this feature, the UPS must have been powered by utility power with output enabled at least once. Battery start can be disabled. See cold start setting in [4.4 User Settings](#).

To Start the UPS on the battery:

1. Press the  button on the UPS front panel until the UPS front panel display illuminates and shows a status of "UPS starting...".

The UPS cycles from Standby mode to Battery mode. The  indicator illuminates solid yellow.  
The UPS supplies power to your equipment.

2. Check the UPS front panel display for active alarms or notices. Resolve any active alarms before continuing. See [8.1 Typical Alarms and Faults](#).

### 5.3 UPS Shutdown

To shut down the UPS:

1. Press the  button on the front panel for three seconds. A confirmation message will appear. When confirmed, the UPS starts to beep and shows a status of "UPS shutting OFF". The UPS then transfers to Standby Mode.
2. Set the upstream circuit breaker (not provided) to the "O" position (off) to switch off the utility power.

## Chapter 6 Modes of Operation

### 6.1 Online Mode

During Online mode, the  indicator illuminates solid green and the UPS is powered from the utility. The UPS monitors and charges the batteries as needed and provides filtered power protection to your equipment. Optional High-Efficiency and Energy Saving settings minimize heat contribution to the rack environment.

### 6.2 Battery Mode

When the UPS is operates during a power outage, the alarm beeps once every ten seconds, and the  indicator illuminates solid yellow. The battery provides the necessary energy. When the utility power returns, the UPS transfers to the Online mode of operation while the battery recharges. If battery capacity becomes low while in Battery Mode, the audible alarm beeps once every three seconds. This warning is approximate, and the actual time to shutdown may vary significantly. Shut down all applications on the connected equipment, because automatic UPS shut down is imminent. The UPS automatically restarts when utility power is restored after the UPS shuts down.

### 6.3 Low Battery Warning

- The  indicator illuminates solid yellow.
- The audio alarm beeps every three seconds.

The remaining battery power is low. Shut down all applications on the connected equipment because automatic UPS shutdown is imminent.

End of battery backup time

- LCD displays "End of backup time."
- All of the LEDs are OFF.
- The audio alarms will stop.

### 6.4 Bypass Mode

In the event of a UPS overload or internal failure, the UPS transfers your equipment to utility power. Battery mode is not available, and your equipment is not protected, However, the UPS continues to filter utility power.

The  indicator illuminates. Depending on overload conditions, the UPS remains in Bypass mode for at least five seconds and will stay in this mode if three transfers to Bypass occur within twenty minutes.

The UPS transfers to Bypass mode when:

- the user activates Bypass mode through the front panel.
- the UPS detects an internal failure.
- the UPS has an over-temperature condition.
- the UPS has an overload condition listed in [9.1 Model Specifications](#).

The UPS shuts down after a specified delay for overload conditions listed in [9.1 Model Specifications](#). The UPS remains on to alarm the fault.

### 6.5 Standby Mode

When the UPS is turned off and remains connected to the AC source, the UPS is in Standby mode.

The output is powered but not protected if the Bypass Standby setting is enabled.

The battery recharges when necessary and the communication ports are powered.

### 6.6 Transferring Between Modes

**From Online (or Battery) to Bypass mode.** Press any button to activate the menu options, then select Control and go to Bypass.

**From Bypass to Online (or Battery) mode.** Press any button to activate the menu options, then select Control and go to back Normal.

See for help with navigation between settings.

### 6.7 Setting High-Efficiency mode

In High-Efficiency mode, the UPS operates on bypass and transfers to Online (or Battery) mode in less than 10 ms when the utility fails. Transfers to High-Efficiency mode will be active after five minutes of bypass voltage monitoring: if bypass quality is out of tolerance, then the UPS will remain in Online mode.

Eaton recommends using High-Efficiency mode only to protect IT equipment.

To set the High-Efficiency mode:

1. Select settings, In/Out settings, and High-Efficiency mode.
2. Select Enabled and press enter to confirm.
3. The UPS transfers to High-Efficiency mode after five minutes.

### 6.8 Configuring Battery Settings

#### Automatic Battery Tests

Automatic battery tests occur once a month in constant charging mode.

The battery test frequency can be modified.

During the test, the UPS transfers to Battery mode and discharges the batteries for ten seconds under load.

#### Low battery warning

During discharge, the low battery alarm is activated if the remaining runtime goes below three minutes or less than the setting capacity threshold (0% by default). This threshold can be modified.







#### Restart battery level

This setting is used to define the battery restart level. The battery level must reach this threshold (0% by default) to enable the UPS to start.

See the section to modify these settings.

### 6.9 Retrieving the Event Log

To retrieve the event log through the display:

1. From the UPS home menu, press the  button to enter User Settings.
2. In the User Settings screen press the  or  button until the Event Log menu is displayed.
3. Press the  button. Use the  or  buttons to display the events.

The log retains 50 events, with the most recent event listed first. Press the esc button twice to return to the UPS home menu.

## Chapter 7 UPS Maintenance

### 7.1 Equipment Care

For the best preventive maintenance, keep the area around the equipment clean and dust free. If the atmosphere is very dusty, clean the outside of the system with a vacuum cleaner. For full battery life, keep the equipment at an ambient temperature of 25° C (77° F).

If the UPS needs to be transported, verify that the battery is disconnected and the UPS is turned off. The batteries are rated for a 3-5 year service life. The length of service life varies, depending on the frequency of use and ambient temperature (product life divided by two for each ten degrees C over 25).

Batteries used beyond expected service life will often have reduced runtimes. Replace batteries at least every four years to keep units running at peak efficiency. Battery runtime will be reduced at low temperatures (below 10° C).

### 7.2 Storing the Equipment

If you store the equipment for an extended period, recharge the battery every six months by connecting the UPS to utility power. The internal batteries charge to 90% capacity in less than 3 hours. However, Eaton recommends charging the batteries for 48 hours after long-term storage. Check the battery recharge date on the shipping carton label. If the date has passed and the batteries were never recharged, do not use them. Contact your service representative.

### 7.3 Replacing the Batteries



#### IMPORTANT

---

DO NOT DISCONNECT the batteries while the UPS is in Battery Mode.

---

Batteries can be replaced easily without turning off the UPS or disconnecting the load. If you prefer to remove input power to change the batteries, see [5.3 UPS Shutdown](#).

Consider all warnings, cautions, and notes before replacing batteries.

- Servicing should be performed by qualified service personnel knowledgeable of batteries and required precautions. Keep unauthorized personnel away from batteries.
- Batteries can present a risk of electrical shock or burn from a high short circuit current. Observe the following precautions:
  1. Remove watches, rings, or other metal objects
  2. Use tools with insulated handles
  3. Do not lay tools or metal parts on top of batteries
  4. Wear rubber gloves and boots
- When replacing batteries, use the same type and number of batteries or battery packs. Contact your service representative to order new batteries.
- Proper disposal of batteries is required. Refer to your local regulations for proper disposal requirements.
- Never dispose of batteries in a fire. Batteries may explode when exposed to flame.
- Do not open or mutilate the batteries. Released electrolyte is highly toxic and will harm your eyes and skin.
- Determine whether the battery is inadvertently grounded. If it is inadvertently grounded, remove the source from the ground. Contact with any part of a grounded battery can result in electrical shock. The likelihood of such shock can be reduced if such grounds are removed during installation and maintenance (applicable to equipment and remote battery supplies not having a grounded supply circuit).

- Disconnect the charging source prior to connecting or disconnecting battery terminals.

---

**WARNING**

---

ELECTRIC ENERGY HAZARD. Do not attempt to alter any battery wiring or connectors. Attempting to alter wiring can cause injury.

---

### Replacing the internal battery

The internal battery is heavy. Use caution when handling heavy batteries.

**Figure 13. Internal Battery Pack Replacement**

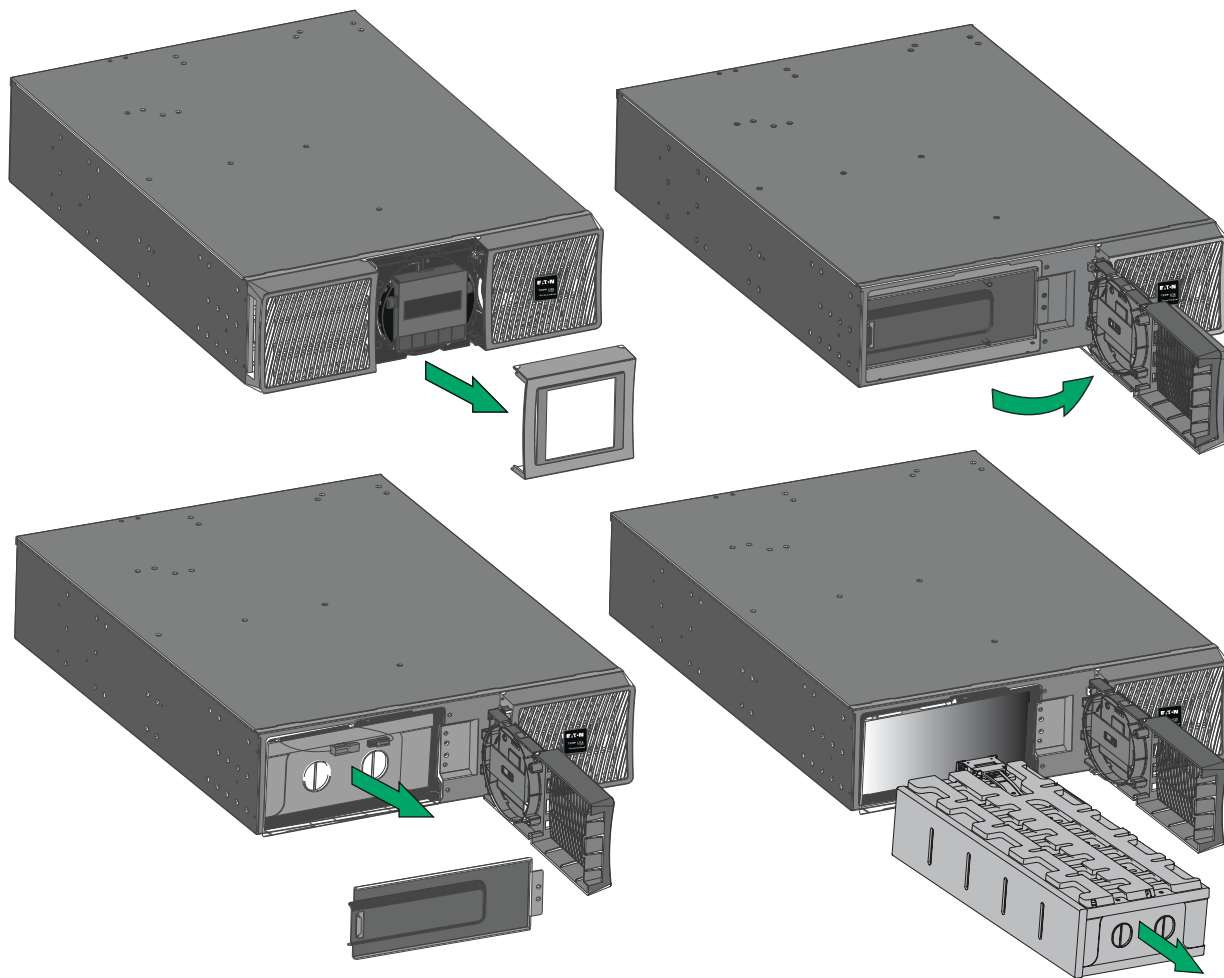

To replace the battery pack:

1. Remove the center cover of the front panel.
2. Remove the two screws to open the left front panel.
3. Disconnect the battery connectors.

A ribbon cable connects the LCD control panel to the UPS. Do not pull or disconnect the cable.

4. Remove the two screws to pull out the metal battery protection cover.
5. Pull out the handle of the battery pack, and slide the pack out slowly onto a flat and stable surface. Use two hands to support the battery pack. See [7.4 Recycling The Used Equipment](#) for proper disposal.
6. Verify that the replacement batteries have the same rating as those being replaced.
7. Put the new battery pack into the UPS. Seat the battery pack firmly into the UPS,
8. Verify that all of the alarms have cleared on the display.
9. Screw back the metal battery protection cover and the front panel, then clip the center cover back into place.
10. If the UPS was shut down during the battery replacement process, see [5.1 Startup and Normal Operation](#) to power the UPS back on.

### Replacing the EBM(s)

The EBM is heavy. Lifting the cabinet into a rack requires a minimum of two people.

To replace the EBM(s):

1. Unplug the UPS's EBM power and battery detection cables. If additional EBM(s) are installed, unplug the EBM power cable and battery detection cable from each EBM.
2. Replace the EBM(s). See [7.4 Recycling The Used Equipment](#) for proper disposal.  
A small amount of arcing may occur when connecting an EBM to the UPS which is normal and will not harm personnel. Insert the EBM cable into the UPS battery connector quickly and firmly.
3. Plug the EBM cable(s) into the battery connector(s). Up to four EBMs may be connected to the UPS.
4. Verify that the EBM connections are tight and that each cable has adequate bend radius and strain relief.
5. Connect the battery detection cable(s) to the UPS connector and the EBM(s).
6. If the UPS was shut down during the battery replacement process follow the start procedure in the Start-up and Normal Operation section.

## 7.4 Recycling The Used Equipment

Contact your local recycling or hazardous waste center for information on proper disposal of the used equipment.



**RISK OF ELECTRIC SHOCK** - Observe the warning associated with the risk of electric shock symbol.



This symbol indicates that you should not discard the UPS or the UPS batteries in the trash. This product contains sealed, lead-acid batteries and must be disposed of properly. For more information, contact your local recycling/reuse or hazardous waste center.



This symbol indicates that you should not discard waste electrical or electronic equipment (WEEE) in the trash. For proper disposal, contact your local recycling/reuse or hazardous waste center.

## Chapter 8 Troubleshooting

### 8.1 Typical Alarms and Faults

The Eaton Tripp Lite Series UPS alerts you to whenever potential operating problems occur. The alarms shown by the control panel do not mean that the output power is affected. Instead, they are preventive alarms intended to alert the user.

- Events are silent status information that is recorded in the Event log. For example = "AC freq in range."
- Alarms are recorded in the Event log and display on the LCD status screen. Some alarms may be announced by a beep every three seconds. For example = "Battery low."
- Faults are announced by a continuous beep and a red LED, recorded into the fault log, and display on the LCD with a specific message box. For example = Output short circuit.





Use the following troubleshooting chart to determine the UPS alarm condition.





#### Checking the Alarms and Faults

To check the Event log or Fault log :

1. Press any button on the front panel display to activate the menu options.
2. Press the ▼ button to select Event log or Fault log.
3. Scroll through the list of events or faults.

The following table describes typical conditions.

Conditions	Possible cause	Action
Battery mode  LED is on One beep every ten seconds	A utility failure has occurred, and the UPS is in Battery mode.	The UPS is powering the equipment with battery power. Prepare your equipment for a shutdown.
Battery mode  LED is on One beep every three seconds	The UPS is in Battery mode, and the battery is running low.	This warning is approximate, and the actual time to shut down can vary significantly. Depending on the UPS load and number of Extended Battery Modules (EBMs), the Battery Low warning may occur before the batteries reach 20% capacity.
No battery  LED is on Beep continuous	The batteries are disconnected.	Verify that all batteries are properly connected. To clear a battery disconnected alarm initiate a battery test. If the condition persists, contact your service representative.
Battery fault  LED is on Beep continuous	The battery test failed due to discharged or disconnected batteries.	Verify that all batteries are properly connected. To clear a battery disconnected alarm initiate a battery test. If the condition persists, contact your service representative.
The UPS does not provide the expected backup time	The batteries need charging or service.	Apply utility power for 48 hours to charge the batteries. If the condition persists, contact your service representative.

Conditions	Possible cause	Action
Bypass mode  LED is on	An overload or a fault has occurred, or a command has been received, and the UPS is in Bypass mode.	Equipment is powered but not protected by the UPS. Check for one of the following alarms: over-temperature or overload alarms, or that the red LED on the UPS is on.
Power overload  LED is on	Power requirements exceed the UPS capacity (greater than 100% of nominal).	Remove some of the equipment from the UPS. The UPS continues to operate, but may switch to Bypass mode or shut down if the load increases. The alarm resets when the condition becomes inactive.
UPS over temperature  LED is on. One beep every three seconds	The UPS internal temperature is too high or a fan has failed. At the warning level, the UPS generates the alarm but remains in the current operating state. If the temperature rises another One0° C, the UPS transfers to Bypass mode or shuts down if Bypass is unusable.	If the UPS transferred to Bypass mode, the UPS will return to normal operation when the temperature drops 5° C below the warning level. If the condition persists, shut down the UPS. Clear vents and remove any heat sources. Allow the UPS to cool. Ensure the airflow around the UPS is not restricted. Restart the UPS. If the condition persists, contact your service representative.
The UPS does not start	The input source is not connected correctly.	Check the input connections.
	The Remote Power Off (RPO) switch is active or the RPO connector is missing.	If the UPS Status menu displays "Remote Power Off", deactivate the RPO input.
Input bad wiring / Output bad wiring  LED is on Beep is continuous	Input/Output cables are not connected to the correct terminal blocks.	Correctly connect the Input/Output cables.

## 8.2 Silencing the Alarm

Press the ESC button on the front panel display to silence the alarm. Check the alarm condition and perform the appropriate action to resolve the situation. If the alarm status changes, the alarm will beep again, overriding the previous alarm silencing.



### 8.3 Service and Support

If you have any questions or problems with the UPS, call your **Local Distributor** or **Eaton Support** at one of the following telephone numbers and ask for a UPS technical representative.

United States:	<b>1-800-356-5737</b>
Canada:	<b>1-800-461-9166 ext 260</b>
All other countries:	<b>Call your local service representative</b>

Please have the following information ready when you call Eaton Support:

- Model number
- Serial number
- Version number (if available)
- Date of failure or problem
- Symptoms of failure or problem
- Customer return address and contact information

If repair is required, you will be given a Returned Material Authorization (RMA) number. This number must appear on the outside of the package and on the Bill Of Lading (if applicable). Use the original packaging or request packaging from Eaton Support or your local distributor. Units damaged in shipment as a result of improper packaging are not covered under warranty. A replacement or repair unit will be shipped, and freight prepaid for all units within the warranty period.



**NOTE**

For critical applications, immediate replacement may be available. Call **Eaton Support** for the dealer or distributor nearest you.

---

# Chapter 9 Specifications

## 9.1 Model Specifications

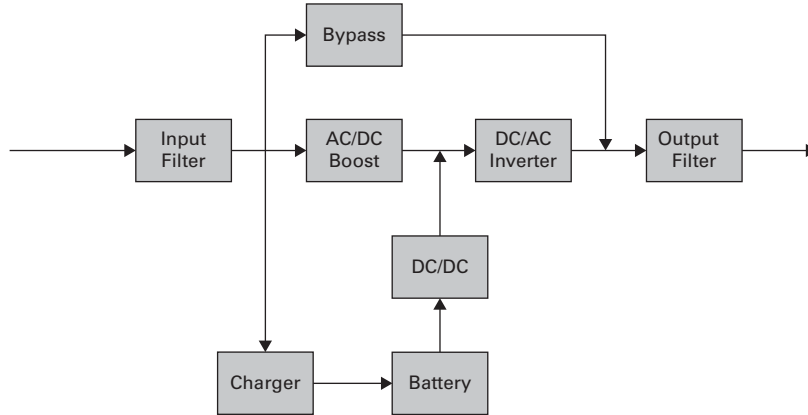

**Table 9. Power Module List**

Model	Power ratings
SU6000RT3UTAA	5200VA / 4600W at 200V output
	5400VA / 4800W at 208V output
	5700VA / 5100W at 220V output
	6000VA / 5300W at 230V output
	6000VA / 5400W at 240V output

**Table 10. Electrical Input**

Model	Default input voltage	Input nominal voltages / Max Current		Input voltage window at rated load
		Voltage	Current	
SU6000RT3UTAA	208V	200V	25.8A	176-276V
		208V	24.8A	
		220V	23.5A	
		230V	22.4A	
		240V	21.5A	
Nominal frequency		50/60Hz auto-sensing		
Frequency range		50Hz : 40-60Hz before transfer to battery 60Hz : 40-70Hz before transfer to battery		
Bypass voltage range		-20% / +15% of nominal value (default)		
Noise filtering		MOV for normal and common mode noise		



**Table 11. Extended Battery Module List**

Model	Configuration	Battery voltage
BP180RT3UTAA	Rack / Tower	180Vdc

**Table 12. Weights and Dimensions**

Description	Weights (lb/kg)	Dimensions (inch/mm) D x W x H
SU6000RT3UTAA	106 / 48	28.4 x 17.3 x 5.1 / 722 x 440 x 130
BP180RT3UTAA	150 / 68	25.4 x 17.3 x 5.1 / 645 x 440 x 130

**Table 13. Electrical Input Connections**

Model	Input connection
SU6000RT3UTAA	L6-30P cord or hardwired

**Table 14. Electrical Output**

All models		
Voltage regulation	Normal and Battery Mode $\pm 1\%$	
Efficiency	Normal Mode > 98% (High-Efficiency mode) >93%	Battery mode > 91%
Frequency regulation	Normal mode sync with line $\pm 5\%$ of nominal line frequency (outside this range: $\pm 0.5\%$ of auto-selected nominal frequency)	Battery mode $\pm 0.5\%$ of auto-selected nominal frequency
Nominal output	200/208/220/230/240V (voltage configurable)	
Maximum Output Current	SU6000RT3UTAA	
	200V out : 4600W/26.0A	
	208V out : 4800W/26.0A	
	220V out : 5100W/25.9A	
	230V out : 5300W/26.1A	
Maximum Output Current	240V out : 5400W/25.0A	
Frequency	50 or 60 Hz, auto-sensing or configurable as a frequency converter	
Output overload	100-102% : no alarm 102-110% : load transfers to Bypass mode after 2 minutes 110-125% : load transfers to Bypass mode after 1 minute 125-150% : load transfers to Bypass mode after 10 seconds > 150% : load transfers to Bypass mode after 500 ms	
Output overload ( Bypass mode )	100-125% : no alarm 125-150% : UPS shuts down after one minute > 150% : UPS shuts down after one second	



**Table 14. Electrical Output (Continued)**

All models	
Voltage waveform	Sine wave
Harmonic distortion	< 2% THDV on linear load < 5% THDV on non-linear load
Transfer time	Online mode: 0 ms (no break) High-Efficiency mode: 10 ms maximum (due to loss of utility)
Power factor	Up to 0.9
Load crest ratio	Up to 3:1

**Table 15. Electrical Output Connections**

Model	Output connection	Output cable
SU6000RT3UTAA	Hardwired (2) L6-30R (2) L6-20R	No

**Table 16. Environmental and Safety**

Certifications	IEC/EN 62040-1 IEC/EN 62040-2 :Cat. C2 IEC/EN 62040-3 UL1778 5th edition CSA 22.2
EMC ( Emissions)*	CISPR32 (EN55032) Class A AS/NZS CISPR32 Class A IEC 61000 (-3-11) IEC 61000 (-3-12) FCC part 15 Class A
EMC (Immunity)	IEC 61000-2-2 IEC 61000-4-2, Level 3 IEC 61000-4-3, Level 3 IEC 61000-4-4, Level 4 (also on signal ports) IEC 61000-4-5, Level 4, Criteria B IEC 61000-4-6, Level 3 IEC 61000-4-8, Level 4 IEC 61000-4-11 IEC 61000-4-12
* for output cable < 10m.	
Agency markings*	cTUVus/NOM(TUV NOM)/CE
Operating temperatures	0 to 40°C (32 to 104°F) in Online mode, with linear de rating for altitude <b>Note:</b> thermal protection switches load to bypass in case of overheating.

**Table 16. Environmental and Safety (Continued)**

Storage temperatures	0 to 40°C (32 to 104°F) with batteries -25 to 55°C (-13 to 130°F) without batteries
Transit temperature	-25 to 55°C (-13 to 130°F)
Relative humidity	0 to 96% no condensing
Operating altitude	Up to 3,000 meters (9,843 ft) above sea level with 10% derating per 1000m
Transit altitude	Up to 10,000 meters (32,808 ft) above sea level
Audible noise	< 45 dBA at 1 meter typical

**Table 17. Battery Specifications**

SU6000RT3UTAA Models						
Rack / Tower configuration	Internal batteries 180Vdc			EBM BP180RT3UTAA 180Vdc		
Type	Sealed, maintenance-free, valve-regulated, lead-acid, with minimum 3-year float service life at 25 °C (77 °F). Lifetime is reduced above 25° C (77° F)					
Monitoring	Advanced monitoring for earlier failure detection and warning					
Battery port	External three-pole SBS75G black connector on UPS for connection to EBM					
EBM battery cable length	40 cm (15.7 in)					
Battery charging mode	Constant charging					
Backup time in minutes	Percentage	10%	25%	50%	75%	100%
	Internal	64	25	9.5	5	3.1
	1 EBM	229	95	44	26	18
	2 EBM	454	165	83	50	35
	3 EBM	594	240	113	77	52
Recharge time to reach 90% after a full discharge Time ( In hours)	Internal Battery	1 EBM	2 EBM	3 EBM	4 EBM	
		1.5	7.1	13.7	19.4	27.4

**Table 18. Communications Options**

SU6000RT3UTAA Models	
Communication bay	Available independent communication bay for connectivity card
Compatible connectivity cards	WEBCARDLXE
Communication ports	RS-232 (DB9): 1200-19200 bps USB: 19200 bps



**Table 18. Communications Options (Continued)**

<b>SU6000RT3UTAA Models</b>	
Relay output contacts	Four relay outputs (normally open or normally closed)
Remote On/Off	Two pins jumper (normally open)
Remote power off	Three pins jumper (normally open or normally closed)



DPD-T2TL2206 01