



# KitchenAid

9 Cup Food Processor  
5KFP0921A



In some European factories the letter "W" of the part code mentioned herein will be automatically replaced by the number "4000" (e.g. "W12345678" becomes "400012345678")



# PARTS AND FEATURES

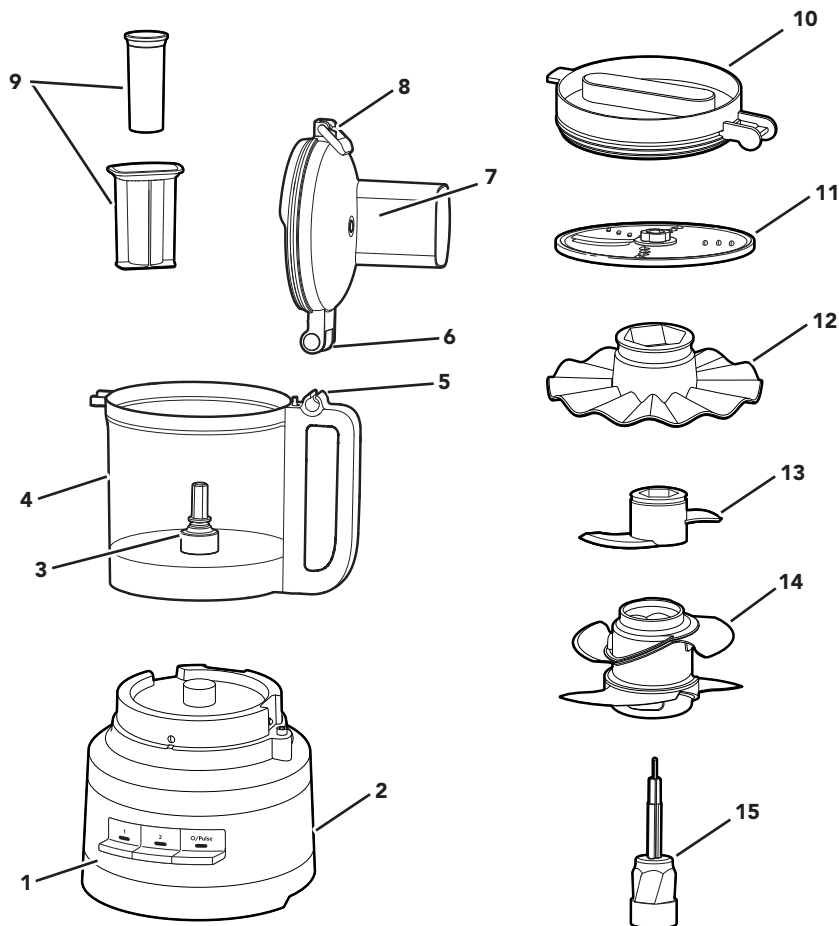

- |   |   |    |                                 |
|---|---|----|---------------------------------|
| 1 | Heavy-Duty Base                         | 8  | Lid Latch                       |
| 2 | Power Cord and Cord Storage (not shown) | 9  | 2-Piece Food Pusher             |
| 3 | Drive Pin                               | 10 | Refrigerator Lid                |
| 4 | 9-Cup (2.1 L) Work Bowl                 | 11 | Reversible Slice/Shredding Disk |
| 5 | Handle Hinge                            | 12 | Whisking Accessory              |
| 6 | Lid Hinge                               | 13 | Dough Blade                     |
| 7 | Work Bowl Cover with 2-in-1 Feed Tube   | 14 | Multi-Purpose Four Blade        |
|   |   | 15 | Drive Adapter                   |



## PRODUCT SAFETY

### Your safety and the safety of others are very important.

We have provided many important safety messages in this manual and on your appliance. Always read and obey all safety messages.



This is the safety alert symbol.

This symbol alerts you to potential hazards that can kill or hurt you and others.

All safety messages will follow the safety alert symbol and either the word "DANGER" or "WARNING." These words mean:

**! DANGER**

**You can be killed or seriously injured if you don't immediately follow instructions.**

**! WARNING**

**You can be killed or seriously injured if you don't follow instructions.**

All safety messages will tell you what the potential hazard is, tell you how to reduce the chance of injury, and tell you what can happen if the instructions are not followed.

## IMPORTANT SAFEGUARDS

When using electrical appliances, basic safety precautions should always be followed, including the following:

1. Read all instructions. Misuse of appliance may result in personal injury.
2. To protect against risk of electrical shock, do not put Food Processor in water or other liquid.
3. This appliance is not intended for use by persons (including children) with reduced physical, sensory or mental capabilities, or lack of experience and knowledge, unless they are closely supervised and instructed concerning use of the appliance by a person responsible for their safety. Close supervision is necessary when any appliance is used by or near children. Children should be supervised to ensure that they do not play with appliance.
4. Turn the appliance OFF, then unplug from the outlet when not in use, before assembling or disassembling parts and before cleaning. To unplug, grasp the plug and pull from the outlet. Never pull from the Power Cord.
5. Avoid contacting moving parts.
6. Do not operate any appliance with a damaged cord or plug, or after the appliance malfunctions, or is dropped or damaged in any manner. Return appliance to the nearest Authorized Service Facility for examination, repair, or electrical or mechanical adjustment.
7. The use of attachments not recommended or sold by KitchenAid may cause fire, electric shock, or injury.
8. Do not use outdoors.
9. Do not let cord hang over edge of table or counter.
10. Keep hands and utensils away from moving Blades or Discs while processing food to reduce the risk of severe injury to persons or damage to the Food Processor. A scraper may be used but must be used only when the Food Processor is not running.



## PRODUCT SAFETY

11. Blades are sharp. Care should be taken when handling the sharp cutting blades, emptying the bowl and during cleaning.
12. If the supply cord is damaged, it must be replaced by the manufacturer, its service agent or similarly qualified persons in order to avoid hazard.
13. To reduce the risk of injury, never place cutting Blade or Discs on Base without first putting Bowl properly in place.
14. Never leave the appliance unattended while it is in operation.
15. Be certain Cover is securely locked in place before operating Food Processor.
16. Never feed food by hand. Always use Food Pusher.
17. Do not attempt to defeat the Cover interlock mechanism.
18. Do not fill the Bowl above the marked maximum fill line (or rated capacity) to avoid risk of injury due to damage to the Cover or Bowl.
19. Refer to the "Care and Cleaning" section for instructions on cleaning the surfaces in contact with food.
20. Be careful if hot liquid is poured into the food processor as it can be ejected out of the appliance due to sudden steaming.
21. This appliance is intended to be used in household and similar applications such as:
  - staff kitchen areas in shops, offices and other working environments;
  - farm houses;
  - by clients in hotels, motels and other residential type environments;
  - bed and breakfast type environments;

## SAVE THESE INSTRUCTIONS

Instructions are also available online, visit our website at:

[www.KitchenAid.com.au](http://www.KitchenAid.com.au) or [www.KitchenAid.co.nz](http://www.KitchenAid.co.nz)

## ELECTRICAL REQUIREMENTS

---

**Voltage:** 220-240 V

**Frequency:** 50-60 HZ

**Wattage:** 250 W

**NOTE:** If the plug does not fit in the outlet, contact a qualified electrician. Do not modify the plug in any way.



## ACCESSORIES SELECTION GUIDE

Action	Setting	Food	Accessory
Whisking/ Whipping	1 or 2	Cream, Eggs	Whisk Accessory
Chop	1 or O/Pulse	Cheese Chocolate Fruits Fresh herbs	Multi-Purpose Four Blade
Mince or Purée	2 or O/Pulse	Nuts Tofu Vegetables	
Mix	1	Pasta Sauce Pesto Salsa Sauces Batters	
Slice	1	Fruit (soft) Potatoes Tomatoes Vegetables (soft)	Reversible Slicing/ Shredding Disc (slicing side)
	2	Cheese Chocolate Fruit (hard) Vegetables (hard)	
Shred (Medium)	1	Potatoes Vegetables (soft)	Reversible Slicing/ Shredding Disc (shredding side)
	2	Cabbage Cheese Chocolate Fruits (hard) Vegetables (hard)	
Knead	O/Pulse / 2	Yeast Dough	Dough Blade



# PRODUCT ASSEMBLY

## Before first use

Before using your Food Processor for the first time, wash all parts and accessories either by hand or in the dishwasher (see "Care and Cleaning" section).

**NOTE:** Your Food Processor is designed so that all accessories may be stored inside the Work Bowl.

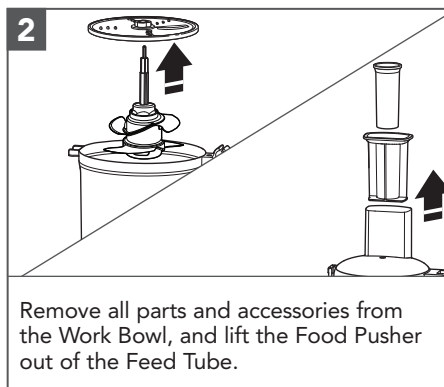
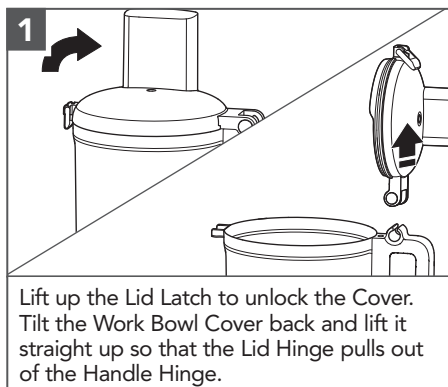

**IMPORTANT:** Place the Food Processor on a dry, level countertop with the controls facing forward. Do not plug in the Food Processor until it is completely assembled.

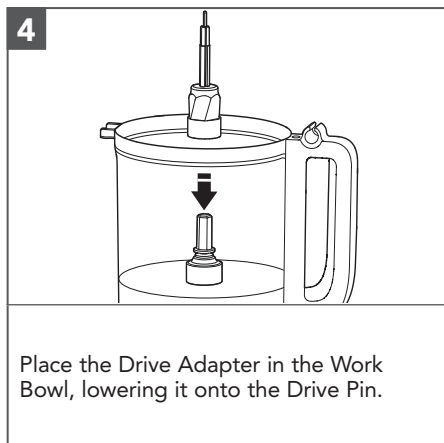
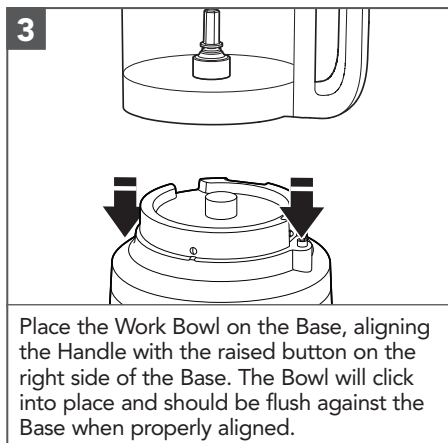



# PRODUCT ASSEMBLY

**NOTE:** For ease of assembly, install the desired Blade or Disc before attaching the Work Bowl Cover.

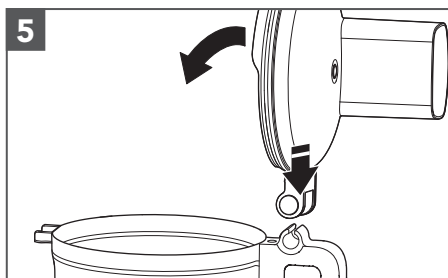

To attach the Work Bowl Cover, hook the Lid Hinge into the Handle Hinge on the Work Bowl and close the Cover.

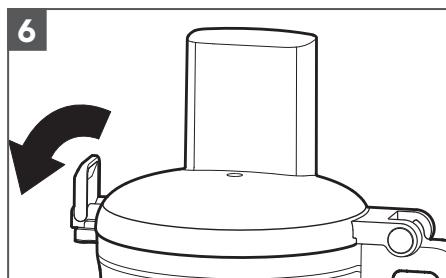

Once the Work Bowl Cover is closed, push the Lid Hinge down into the locked position.

**NOTE:** Your Food Processor will not operate unless the Work Bowl Cover is fully closed and the Work Bowl is properly seated on the Base.

## USING THE REFRIGERATOR LID

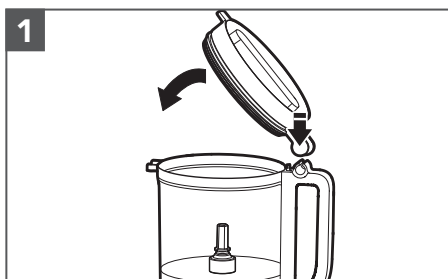

To attach the Refrigerator Lid, hook the Lid Hinge into the Handle Hinge on the Work Bowl and close the Lid.



Once the Refrigerator Lid is closed, push the lid firmly to ensure closure.

## INSTALLING THE MULTIPURPOSE BLADE OR DOUGH BLADE

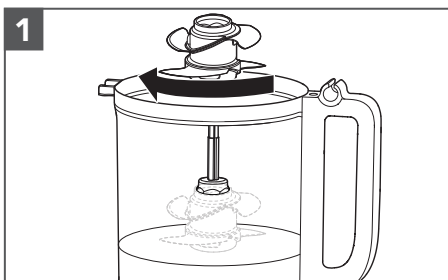

Place the Blade on the Drive Adapter. Rotate the Blade so it falls down to the base of the Adapter.

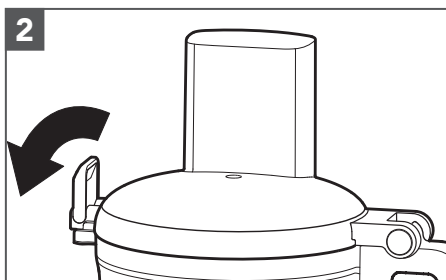

Install the Work Bowl Cover, and be sure the Lid Latch is pushed down to the locked position.



# PRODUCT ASSEMBLY

## INSTALLING THE REVERSIBLE SLICING/SHREDDING DISC

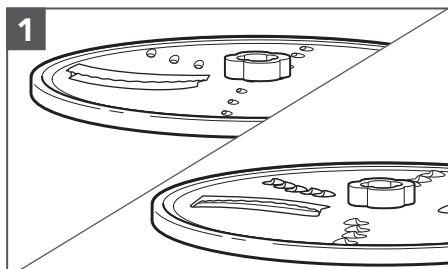

**1**

**To slice:** Turn the Disc so that the raised Slicing Blade is facing up.

**To shred:** Turn the Disc so that the small, raised Shredding Blades are facing up.

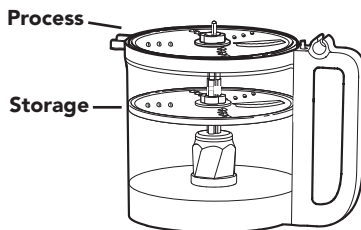

The Disc can be placed in two different positions: level with the top of the Bowl for processing, and lower, inside of the Bowl for storage.

**NOTE:** Make sure the Disc is level with the top of the Bowl for best performance.

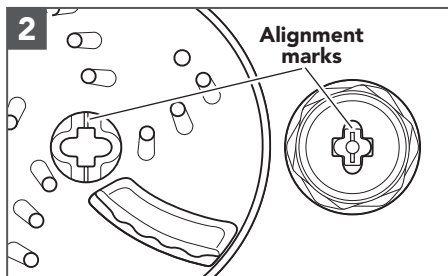

**2**

Hold the Disc by its centre hub and lower it onto the Drive Adapter, aligning the mark on the centre hub of the Disc to the matching mark on the Adapter. When properly placed, the Disc should be level with the top of the Bowl. If the Disc falls to the storage position, lift it out, turn it 90°, and lower it again.

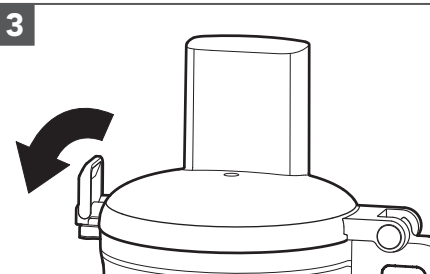

**3**

Install the Work Bowl Cover, and be sure the Lid Latch is pushed down to the locked position.



# PRODUCT ASSEMBLY

## USING THE WHISKING ACCESSORY

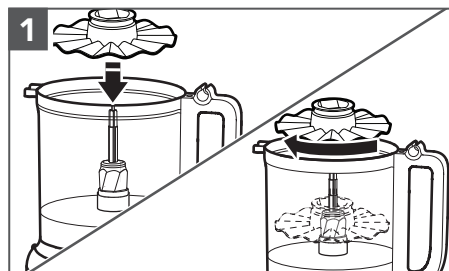

**1** Place the Whisking Accessory onto the Drive Adapter. Rotate the Whisking Accessory so it falls down to the base of the Adapter.

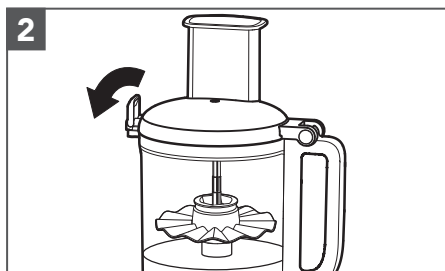

**2** Install the work bowl Cover, and be sure the Lid Latch is pushed down to the locked position.

## PRODUCT USAGE

### ⚠ WARNING



#### Rotating Blade Hazard

- Always use food pusher.
- Keep fingers out of openings.
- Keep away from children.
- Failure to do so can result in amputation or cuts.

Before operating the Food Processor, be sure the Work Bowl, Blades/Disc, and Work Bowl Cover are properly assembled on the Base (see the "Product Assembly" section).

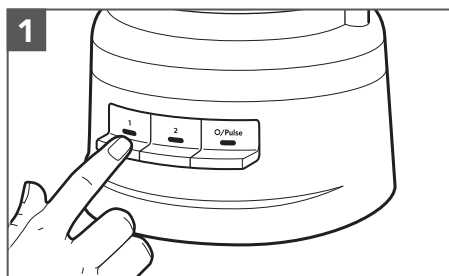

**1** To turn on, press 1 or 2. The Food Processor will run continuously and the indicator light will glow.  
To turn off, press 1 or 2 again, or press O/Pulse.

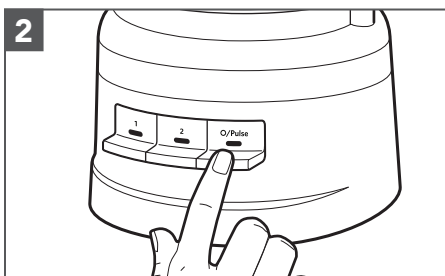

**2** **To use the Pulse function:**  
Press O/Pulse for short bursts, or press and hold for longer bursts. The Pulse function runs at high speed only. The Food Processor will turn off when the O/Pulse button is released.



## PRODUCT USAGE

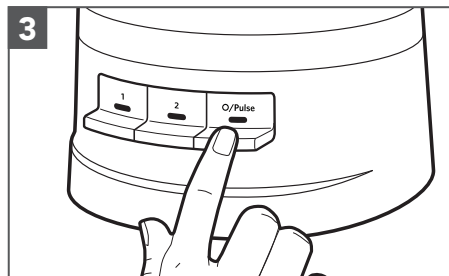

When finished, press the O/Pulse button. The indicator light will go out and the Blade or Disc will slow to a stop.

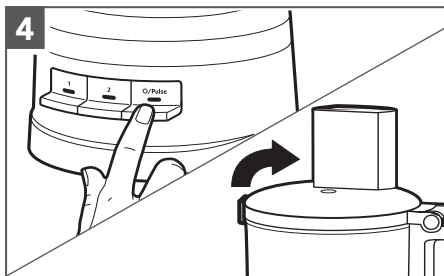

Wait until the Blade or Disc comes to a complete stop before removing the Work Bowl Cover. Be sure to turn off the Food Processor before removing the Work Bowl Cover, or before unplugging the Food Processor.

## USING THE 2-IN-1 FEED TUBE

The 2-in-1 feed tube features a 2-piece Food Pusher. To slice or shred small items, insert the 2-Piece Food Pusher into the Feed Tube.

Use the small Feed Tube and pusher to process small or slender items, like single carrots or celery stalks.

To slowly drizzle oil into ingredients, just fill the small pusher with the desired amount of oil. A small hole in the bottom of the pusher will drizzle the oil at a constant rate.



**2-Piece Food Pusher**

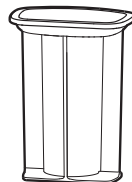

## REMOVING PROCESSED FOODS

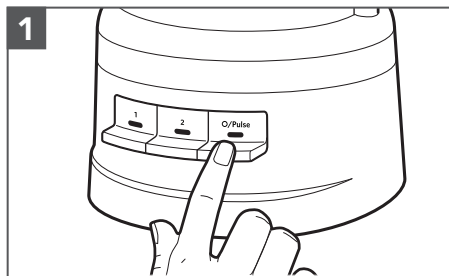

**Turn the Food Processor off:** Press the O/Pulse button and unplug the Food Processor before disassembling.

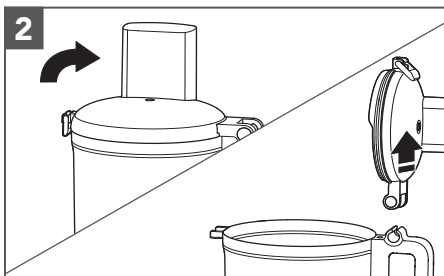

Lift the Lid Latch to unlock the Work Bowl Cover, then lift the Cover to remove.



## PRODUCT USAGE

**3**

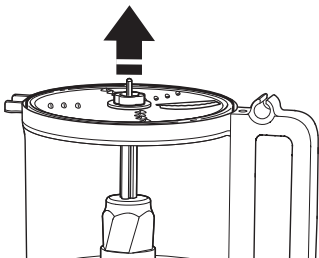

If using the Disc, remove it before removing the Bowl. Holding the Disc by the centre hub, lift it straight up.

**4**

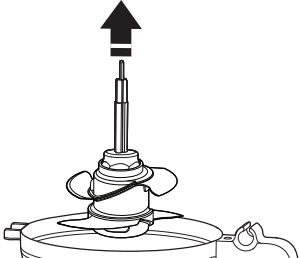

Remove the Drive Adapter and Accessory, if using. The Blade will stay in place on the Drive Adapter when you remove the Adapter.

**5**



Lift the Work Bowl off of the Base to remove food from the Bowl with a spatula.

## RECOMMENDED USAGE AND HELPFUL HINTS

### USING THE DOUGH BLADE

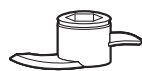

The dough blade is designed for mixing and kneading yeast dough quickly and thoroughly. For the best

results, use **O/Pulse** to mix the dry ingredients and then speed 2 when adding water.

The maximum recommended amount is 375g (3 cups) flour and 260g/ml of water, at a maximum duration of 2 minutes on high speed.

### USING THE MULTI-PURPOSE FOUR BLADE



The multipurpose blade is used to chop and puree foods like fruits, vegetables, nuts, and beans/legumes. This

blade will also mince meats like beef, chicken and pork.

The maximum recommended amount for mincing is 200g beef, on high speed for a maximum duration of 10s.



# RECOMMENDED USAGE AND HELPFUL HINTS

## USING THE WHISKING ACCESSORY

---



The whisking accessory is used to whisk and whip quickly and thoroughly. For the best results, use O/Pulse to whisk/whip to desired texture.

The maximum recommended capacity for liquid is 500g on high speed for a maximum duration of 2 minutes.

## USING THE SLICE AND SHRED DISCS

---



The Slice/Shred disk is used to slice and shred fruits, vegetables, cheese and more.

The maximum recommended capacity for shredding or slicing ingredients is 500g for a maximum duration of 2 minutes.



# CARE AND CLEANING

**IMPORTANT:** The BPA-free Bowl requires special handling. If you choose to use a dishwasher instead of hand washing, please follow these guidelines.

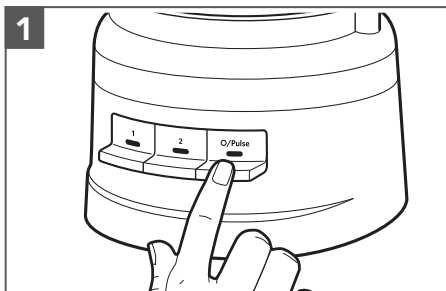

Press the O/Pulse button, then unplug the Food Processor before cleaning.

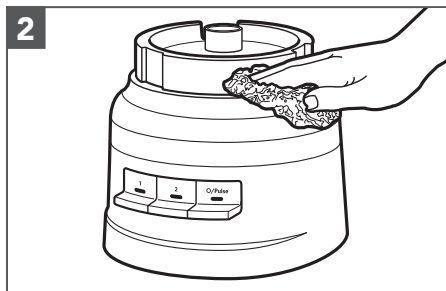

Wipe the base and cord with a warm, damp cloth, and wipe clean with a damp cloth. Thoroughly dry with a soft cloth. Do not use abrasive cleaners or scouring pads. Do not immerse base in water or other liquid.

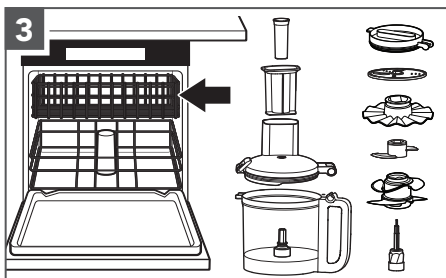

All parts are top rack dishwasher safe. Avoid laying the Bowl on its side. Thoroughly dry all parts after washing. Use gentle dishwashing cycles such as normal. Avoid high-temperature cycles.

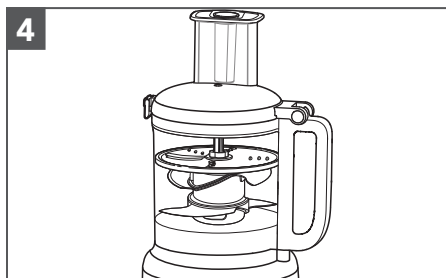

You can store up to two blades and three discs, as well as the drive adapter inside of the Work Bowl when the Food Processor is not in use. Wrap the Power Cord around the Cord Storage on the bottom of the Base, then secure the plug by clipping it to the housing.

**NOTE:** If washing the Food Processor parts by hand, avoid the use of abrasive cleansers or scouring pads. They may scratch or cloud the Work Bowl and Cover.



## TROUBLESHOOTING GUIDE

Problem	Solution
If your Food Processor should malfunction or fail to operate, check the following:	Check to see if the Food Processor is securely plugged into a earthed electrical outlet.
	Make sure that the Bowl and Lid are properly aligned and locked in place.
	Have you pressed more than one button at the same time?
	Unplug the Food Processor, then plug it back into the outlet.
Is the fuse in the circuit to the Food Processor in working order?	If you have a circuit breaker box, be sure the circuit is closed.
The Food Processor may need to cool to room temperature:	If the speed light turns off and the O/Pulse light flashes, wait until the O/Pulse light turns off and retry. The Food Processor may take from 5-15 minutes to cool completely.
The motor may be locked:	If the speed light stays on while the O/Pulse light flashes, press the O/Pulse button to reset the motor.
Food Processor not shredding or slicing properly:	Make sure the raised-Blade side of the Disc is positioned face up on the Drive Adapter.
	Make sure ingredients are suitable for slicing or shredding.
	Make sure the Disc is positioned in the process position (near the top of the Bowl), and not the storage position (low and inside of the Bowl).
If the Work Bowl Cover won't close when using the Disc:	Make sure the Disc is installed correctly, and is positioned properly on the Drive Adapter.
If the problem cannot be corrected:	See the "Customer Service" section. Do not return the Food Processor to the retailer. Retailers do not provide service.



# CUSTOMER SERVICE

## In Australia:

For any questions, or to find the nearest Authorised KitchenAid Service Centre, please find our contact details below.

**NOTE:** All service should be handled locally by an Authorised KitchenAid Service Centre.

**Toll free number:** 1-800-990-990

**Phone number:** 02 49026500

## Address Australia:

KitchenAid Australia Pty Ltd  
6-8 Billbrooke Close  
Cameron Park NSW 2285, Australia  
Phone: 1-800-990-990  
Mobile: 0249026500  
Email: enquiries@kitchenaid.com.au

## In New Zealand:

Website: [www.kitchenaid.co.nz](http://www.kitchenaid.co.nz)  
Email: enquiries@kitchenaid.co.nz  
Phone: 0800 881 200

## In other countries:

For all product related questions and after-sales matters, please contact your dealer to obtain the name of the nearest Authorised KitchenAid Service/Customer Centre.

**For more information, visit our website at:**

[www.KitchenAid.com.au](http://www.KitchenAid.com.au)



# KitchenAid

©2021 All rights reserved.

W11517032B

07/21

In some European factories the letter "W" of the part code mentioned herein will be automatically replaced by the number "4000" (e.g. "W12345678" becomes "400012345678")

