

ENGLISH

Canon

DIGITAL
IXUS 40

DIGITAL
IXUS 30



DiG!C II



PictBridge



**DIRECT
PRINT**



**BUBBLE JET
DIRECT**

Camera User Guide

Please read the *Read This First* section (p. 6).

Please also read the *Canon Digital Camera Software Starter Guide Disk* and the *Direct Print User Guide*.

Exif Print



Flowchart and Reference Guides



This Guide

Shooting with the Camera



Canon Digital Camera Software Starter Guide Disk

Installing the Software



This Guide

Connecting the Camera to a Computer



This Guide



Canon Digital Camera Software Starter Guide Disk

Downloading Images to a Computer



Direct Print User Guide



Printer User Guide

Using the Printer and Printing

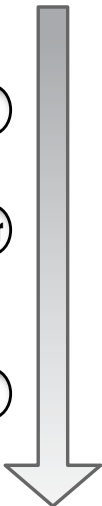

Use of genuine Canon accessories is recommended.

This product is designed to achieve excellent performance optimally when used with genuine Canon accessories. Canon shall not be liable for any damage to this product and/or accidents such as fire, etc., caused by the malfunction of non-genuine Canon accessories (e.g., a leakage and/or explosion of a battery pack). Please note that this warranty does not apply to repairs arising out of the malfunction of non-genuine Canon accessories, although you may request such repairs on a chargeable basis.

Camera Body Temperature

If your camera is used for prolonged periods, the camera body may become warm. Please be aware of this and take care when operating the camera for an extended period.

About the LCD Monitor

The LCD monitor is produced with extremely high-precision manufacturing techniques. More than 99.99% of the pixels operate to specification. Less than 0.01% of the pixels may occasionally misfire or appear as red or black dots. This has no effect on the recorded image and does not constitute a malfunction.

Video Format

Please set the camera's video signal format to the one used in your region before using it with a TV monitor (p. 141).

Charging the Date/Time Battery

- The camera has a built-in rechargeable lithium-ion battery that maintains the date, time and other camera settings. This battery recharges when the main battery pack is inserted into the camera. When you first purchase the camera, place a charged battery pack in it for at least 4 hours to charge the date/time battery. It will charge even when the camera power is turned off.
- If the Date/Time menu appears when the camera power is turned on, it means that the date/time battery charge is depleted. Recharge it as described above.

Conventions Used in the Text

Icons appearing beside or below titles indicate the modes in which the procedure can be used. In the example below, the procedure can be used in the following mode.

When the mode switch is set to  (Shooting) —

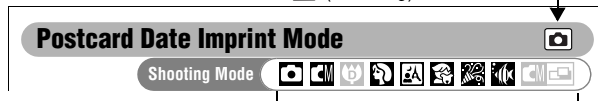

When the Shooting mode is set to the following modes

-  Auto
-  Manual
-  Portrait
-  Night Snapshot
-  Kids&Pets
-  Indoor
-  Underwater

* When a shooting mode icon is shown in gray, the procedure cannot be performed in that mode.

* The  symbol indicates the Stitch Assist mode.



: This mark denotes issues that may affect the camera's operation.



: This mark denotes additional topics that complement the basic operating procedures.

- This guide uses illustrations from the DIGITAL IXUS 40 in its explanations.
- In this guide an SD memory card (Secure Digital, a copyright protection system) is referred to as an SD card.

Items marked with ☆ are lists or charts that summarize camera functions or procedures.

Read This First

Please Read.....	6
Safety Precautions	7
Preventing Malfunctions	12

Components Guide

Components Guide.....	13
DIGITAL IXUS 40	13
DIGITAL IXUS 30	16

Preparing the Camera







Charging the Battery Pack	21
Installing the Battery Pack.....	24
Installing the SD Card	26
Formatting SD Cards.....	28
Setting the Date and Time	31
Setting the Language	34

Basic Functions



Turning the Power On	36
Switching Between Shooting/Playback.....	38
Using the LCD Monitor.....	39
Information Displayed on the LCD Monitor	41
Using the Viewfinder	45
Using the Zoom.....	46
Pressing the Shutter Button	47
☆ Selecting Menus and Settings	49
☆ Menu Settings and Factory Defaults.....	53
Resetting Settings to Their Default Values	58

Shooting

Shooting in Auto Mode	59
Reviewing an Image Right after Shooting	60
Changing Resolution/Compression Settings	62
⚡ Using the Flash	64
Selecting a Shooting Mode	66
Auto	66

Manual	66
Portrait	66
Digital Macro	66
Night Snapshot.....	66
Kids&Pets.....	67
Indoor.....	67
Underwater.....	67
 Shooting Close-Ups/  Infinity Shots.....	68
Magnified Close-Up Shooting (Digital Macro)	70
Using the Digital Zoom	72
 Continuous Shooting.....	73
Postcard Date Imprint Mode.....	74
 Using the Self-timer	76
 Shooting a Movie.....	78
Shooting Panoramic Images (Stitch Assist)	82
Switching between Focusing Modes.....	85
Shooting Hard-to-Focus Subjects (Focus Lock, AF Lock).....	86
Locking the Exposure Setting (AE Lock).....	88
Locking the Flash Exposure Setting (FE Lock).....	89
 Switching between Light Metering Modes	90
Adjusting the Exposure Compensation	91
Shooting in Long Shutter Mode.....	92
Adjusting the Tone (White Balance).....	94
Changing the Photo Effect	97
Adjusting the ISO Speed	98
Setting the Auto Rotate Function	99
Resetting the File Number	100

Playback

Displaying Images Individually	103
 Magnifying Images	104
 Viewing Images in Sets of Nine (Index Playback)	105
Viewing Movies	106
Editing Movies	109
Rotating Images in the Display	111
Attaching Sound Memos to Images.....	112
Automated Playback (Slide Shows)	114
Protecting Images	118

Erasing

 Erasing Single Images	119
Erasing All Images	120

Print Settings

About Printing	122
Setting the DPOF Print Settings	124

Image Transmission Settings (DPOF Transfer Order)

Selecting Images for Transferring	130
---	-----

Connecting the Camera to a Computer

Connecting the Camera to a Computer	133
Computer System Requirements	133
Downloading Images by Direct Transfer	137
Connecting the Camera to the Computer to Download Images without Installing Software	139
Downloading Directly from an SD Card	139

Viewing Images on a TV set

Viewing Images on a TV set	140
----------------------------------	-----

Customizing the Camera (My Camera Settings)

Changing My Camera Settings	142
Registering My Camera Settings	144

List of Messages

List of Messages	148
------------------------	-----

Troubleshooting

Troubleshooting	150
-----------------------	-----

Appendix

Using an AC Adapter Kit (Sold Separately)	154
Camera Care and Maintenance	155
Specifications	156
Photo Tips and Information	164
Index	167
 Functions Available in Each Shooting Mode	176

Please Read

Test Shots

Before you try to photograph important subjects, we highly recommend that you shoot several trial images to confirm that the camera is operating and being operated correctly.

Please note that Canon, its subsidiaries and affiliates, and its distributors are not liable for any consequential damages arising from any malfunction of a camera or accessory, including SD memory cards, that results in the failure of an image to be recorded or to be recorded in a format that is machine readable.

Warning Against Copyright Infringement

Please note that Canon digital cameras are intended for personal use and should never be used in a manner that infringes upon or contravenes international or domestic copyright laws and regulations. Please be advised that in certain cases the copying of images from performances, exhibitions, or commercial properties by means of a camera or other device may contravene copyright or other legal rights even if the image was shot for personal use.

Warranty Limitations

For information on your camera's warranty, please refer to the Canon European Warranty System (EWS) Booklet supplied with your camera.

For Canon Customer Support contacts, please see rear of this booklet or the European Warranty System (EWS) Booklet.

Safety Precautions

- Before using the camera, please ensure that you read and understand the safety precautions described below. Always ensure that the camera is operated correctly.
- The safety precautions noted on the following pages are intended to instruct you in the safe and correct operation of the camera and its accessories to prevent injuries or damage to yourself, other persons and equipment.
- In the next few pages, the term equipment refers primarily to the camera and its power supply accessories, such as the battery charger and separately sold compact power adapter. See the *System Map* for power supply accessory details.

Storing SD cards

Store the SD memory card out of the reach of children and infants.

It may be swallowed accidentally. If this occurs, consult a doctor immediately.

Warnings

-
- **Do not aim the camera directly into the sun or at other intense light sources that could damage your eyesight.**
-
- **Do not trigger the flash in close proximity to human or animal eyes.** Exposure to the intense light produced by the flash may damage eyesight. In particular, remain at least one meter (39 inches) away from infants when using the flash.
-
- **Store this equipment out of the reach of children and infants.** Accidental damage to the camera or battery pack by a child could result in serious injury. In addition, placement of the strap around the child's neck could result in asphyxiation.
-
- **Do not attempt to disassemble or alter any part of the equipment that is not expressly described in this guide.** Disassembly or alteration may result in high-voltage electrical shock. Internal inspections, alterations and repairs should be conducted by qualified service personnel authorized by your camera distributor or a Canon Customer Support Help Desk.
-

-
- **To avoid the risk of high-voltage electrical shock, do not touch the flash portion of the camera if it has been damaged.** Similarly, never touch internal portions of the equipment that become exposed as a result of damage. There is a risk of high-voltage electrical shock. Please take the first opportunity to consult your camera distributor or the closest Canon Customer Support Help Desk.

 - **Stop operating the equipment immediately if it emits smoke or noxious fumes.** Failure to do so may result in fire or electrical shock. Immediately turn the camera power off, remove the battery pack or unplug the battery charger from the power outlet. Confirm that smoke or fume emissions have ceased. Please consult your camera distributor or the closest Canon Customer Support Help Desk.

 - **Stop operating the equipment if it is dropped or the casing is damaged.** Failure to do so may result in fire or electrical shock. Immediately turn the camera power off, remove the battery pack or unplug the power cable from the power outlet. Please consult your camera distributor or the closest Canon Customer Support Help Desk.

 - **Do not allow the equipment to come into contact with, or become immersed in, water or other liquids.** Do not allow liquids to enter the interior. The camera has not been waterproofed. If the exterior comes into contact with liquids or salt air, wipe it dry with a soft, absorbent cloth. If water or other foreign substances enter the interior, immediately turn the camera power off and remove the camera battery pack or unplug the power cord from the power outlet. Continued use of the equipment may result in fire or electrical shock. Please consult your camera distributor or the closest Canon Customer Support Help Desk.

 - **Do not use substances containing alcohol, benzene, thinners or other flammable substances to clean or maintain the equipment.** The use of these substances may lead to fire.

 - **Remove the power cord on a regular periodic basis and wipe away the dust and dirt that collects on the plug, the exterior of the power outlet and the surrounding area.** In dusty, humid or greasy environments, the dust that collects around the plug over long periods of time may become saturated with humidity and short-circuit, leading to fire.
-

-
- **Do not cut, damage, alter or place heavy items on the power cord.** Any of these actions may cause an electrical short circuit, which may lead to fire or electrical shock.
-
- **Do not handle the power cord if your hands are wet.** Handling it with wet hands may lead to electrical shock. When unplugging the cable, ensure that you hold the solid portion of the plug. Pulling on the flexible portion of the cable may damage or expose the wire and insulation, creating the potential for fires or electrical shocks.
-
- **Use only recommended power accessories.** Use of power sources not expressly recommended for this equipment may lead to overheating, distortion of the equipment, fire, electrical shock or other hazards.
-
- **Do not place the battery pack near a heat source or expose it to direct flame or heat.** Neither should you immerse it in water. Such exposure may damage the battery pack and lead to the leakage of corrosive liquids, fire, electrical shock, explosion or serious injury.
-
- **Do not attempt to disassemble, alter or apply heat to the battery pack.** There is serious risk of injury due to an explosion. Immediately flush with water any area of the body - including the eyes and mouth, or clothing - that comes into contact with the inner contents of a battery. If the eyes or mouth contact these substances, immediately flush with water and seek medical assistance.
-
- **Avoid dropping or subjecting the battery pack to severe impacts that could damage the casings.** It could lead to leakage and injury.
-
- **Do not short-circuit the battery terminals with metallic objects, such as key holders.** It could lead to overheating, burns and other injuries. Use the supplied terminal cover to transport or store the battery pack.
-
- **Before you discard a battery, cover the terminals with tape or other insulators to prevent direct contact with other objects.** Contact with the metallic components of other materials in waste containers may lead to fire or explosions. Discard the battery pack in specialized waste facilities if available in your area.
-
- **Use only recommended battery pack and accessories.** Use of battery pack not expressly recommended for this equipment may cause explosions or leaks, resulting in fire, injury and damage to the surroundings.
-

-
- **Use the specified battery charger to charge Battery Pack NB-4L.** Use of other chargers may lead to overheating, distortion of the equipment, fire or electrical shock.

 - **Disconnect the battery charger and compact power adapter from both the camera and the power outlet after recharging and when they are not in use to avoid fire and other hazards.** Continuous use over a long period may cause a unit to overheat and distort, resulting in fire.

 - **The battery charger and compact power adapter are designed for exclusive use with your camera.** Do not use it with other products or batteries. There is a risk of fire and other hazards.
-

Caution about magnetic fields

Keep objects that are sensitive to magnetic fields (such as credit cards) away from the speaker of the camera (p.14, 17). Such items may lose data or stop working.

Cautions

- **Avoid using, placing or storing the equipment in places subject to strong sunlight or high temperatures, such as the dashboard or trunk (boot) of a car.** Exposure to intense sunlight and heat may cause the batteries to leak, overheat or explode, resulting in fire, burns or other injuries. High temperatures may also cause deformation of the casing. Ensure that there is good ventilation when using the battery charger to charge the battery pack.

 - **Do not store the equipment in humid or dusty areas.** Storage in such areas could lead to fire, electrical shock or other damage.

 - **Be careful not to bang the camera or subject it to strong impacts or shocks that could lead to injury or damage the equipment when wearing or holding it by the strap.**

 - **Be careful not to cover the flash with your fingers or clothing when shooting.** The flash may be damaged and emit smoke or noise. In addition, do not touch the surface of the flash after taking several pictures in rapid succession. Either action could result in burns.

 - **Do not operate the flash with dirt, dust or other items stuck to its lens.** The resulting heat build-up could damage the flash.

 - **Ensure that the battery charger is plugged into a power outlet of the specified rating, not over the specified rating.** The plug of the battery charger varies according to region.

 - **Do not use the battery charger or compact power adapter if the plug or cable is damaged, or if the plug is not fully inserted into the power outlet.**

 - **Do not allow metal objects (such as pins or keys) or dirt to contact the charger terminals or plug.**

 - **If your camera is used for prolonged periods, the camera body may become warm.** Please take care when operating the camera for extended periods as your hands may experience a burning sensation.
-

Preventing Malfunctions

Avoid Strong Magnetic Fields

Never place the camera in close proximity to electric motors or other equipment generating strong electromagnetic fields. Exposure to strong magnetic fields may cause malfunctions or corrupt image data.

Avoid Condensation Related Problems

Moving the equipment rapidly between hot and cold temperatures may cause condensation (water droplets) to form on its external and internal surfaces. You can avoid this by placing the equipment in an airtight, resealable plastic bag and letting it adjust to temperature changes slowly before removing it from the bag.

If Condensation Forms Inside the Camera

Stop using the camera immediately if you detect condensation. Continued use may damage the equipment. Remove the SD card and battery pack or compact power adapter from the camera and wait until the moisture evaporates completely before resuming use.

Extended Storage

When not using the camera for extended periods of time, remove the battery pack from the camera or battery charger and store the equipment in a safe place. Storing the camera for extended periods with a battery pack installed will run down the battery pack. However the date, time and other camera settings may reset to default settings if the battery pack has been removed for more than three weeks.

DIGITAL IXUS 40

Front View

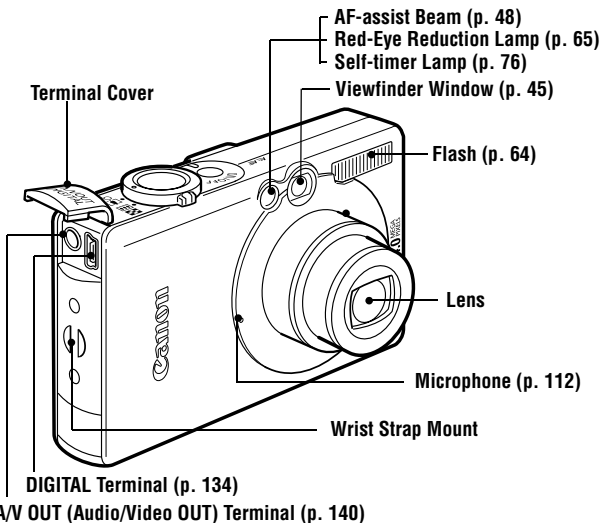

The interface cable and AV cable cannot be connected simultaneously.

How to Open the Terminal Cover

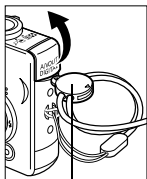

You can use this toggle to open the terminal cover or SD card slot/battery cover.

Attaching the Wrist Strap*

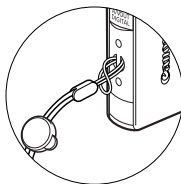

* When carrying the camera by the strap, be careful not to swing the camera or catch it on other items.

Back View

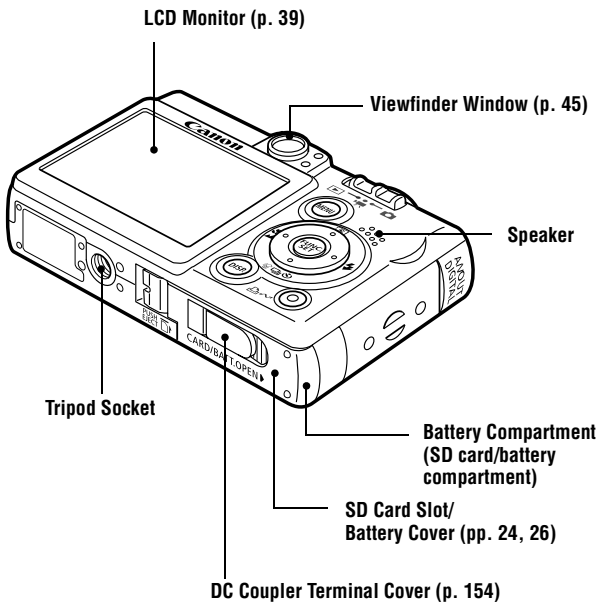

Operation Panel

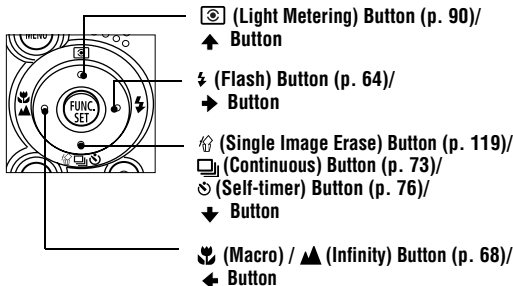
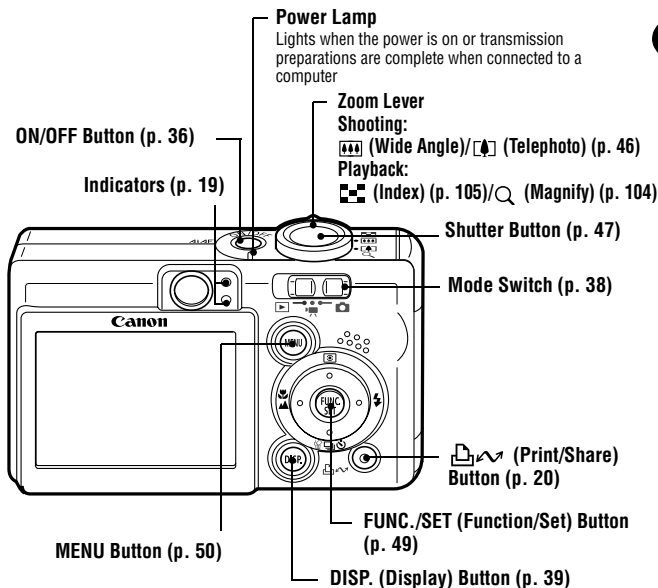

Front View

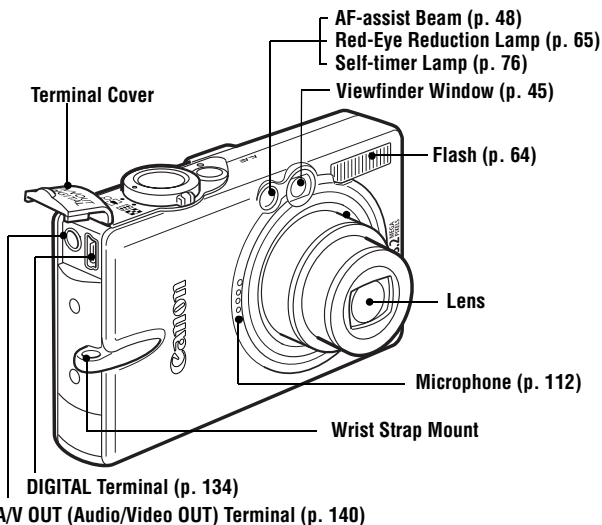

The interface cable and AV cable cannot be connected simultaneously.

How to Open the Terminal Cover

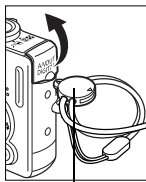

You can use this toggle to open the terminal cover or SD card slot/battery cover.

Attaching the Wrist Strap*

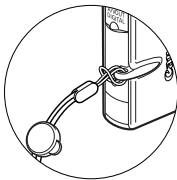

* When carrying the camera by the strap, be careful not to swing the camera or catch it on other items.

Back View

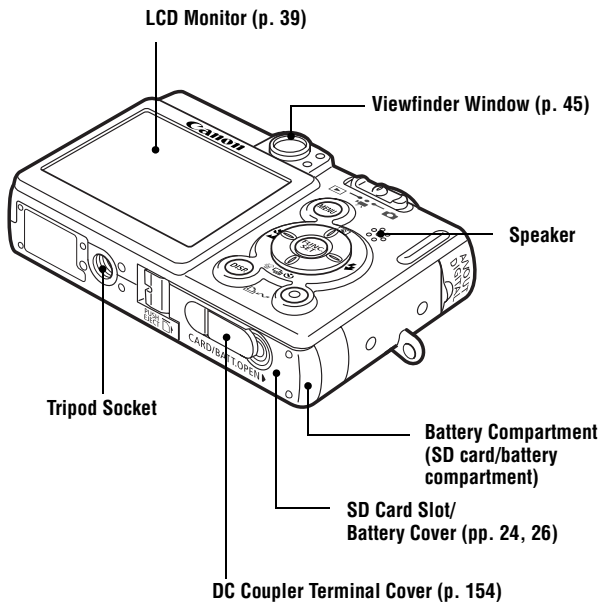

Operation Panel

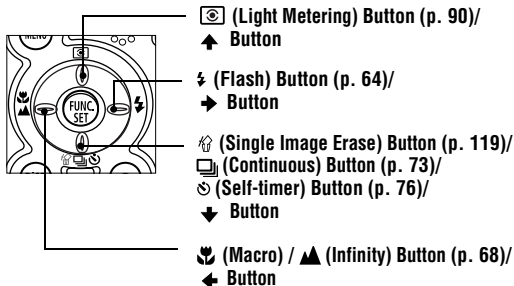
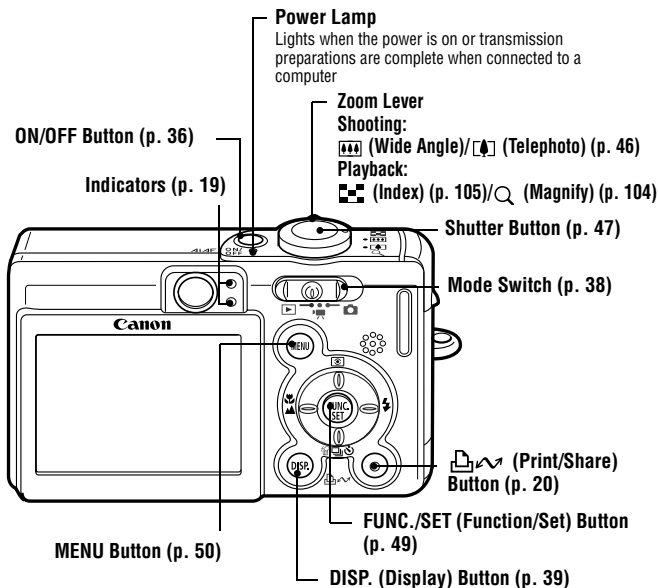

Holding the Camera

Images become blurred if the camera moves when the shutter button is pressed. Hold the camera as shown below to avoid camera movement when shooting.

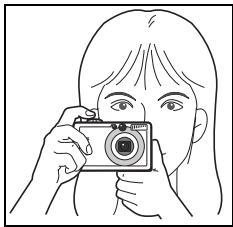

Hold the camera firmly with both hands and let your elbows rest at your sides. Place your finger on the shutter button as you hold the camera.

- Make sure that your hair or fingers do not obstruct the lens, flash, self-timer lamp, microphone or speaker.
- Fix the camera onto a tripod when shooting infinity shots or in dark places.

Indicators

The indicators light or blink when the **ON/OFF** button or shutter button is pressed.

Upper Indicator

Green: Ready to shoot

Blinking Green: Recording to SD card / Reading SD card / Erasing from SD card/Transmitting data (during a computer connection)

Orange: Ready to shoot (flash on)

Blinking Orange: Ready to shoot (camera shake warning)

Lower Indicator

Yellow: Macro mode / Infinity mode/ AF lock

Blinking Yellow: Focusing difficulty (single beep).

Although you can still press the shutter button when the indicator blinks yellow, you are recommended to shoot using the focus lock or AF lock (p. 86).

The following operations are accessible through one easy press of the  (Print/Share) button.

- Printing: See the *Direct Print User Guide* (supplied with the camera)
- Downloading images (Windows only): See p.132 of this guide and the *Canon Digital Camera Software Starter Guide Disk* (supplied with the camera)

The indicator blinks or lights during a printer or computer connection.

Blue: Ready to print/Ready to transfer images

Blinking blue: Printing/Transferring

The following cables are used to connect the camera to a computer or printer.

Computer (p. 132)

Interface Cable IFC-400PCU (supplied with the camera)

Direct Print Compatible Printers (Sold Separately)

- Compact Photo Printer (SELPHY CP series)/Card Photo Printer
Interface Cable IFC-400PCU (supplied with the camera) or the Direct Interface Cable DIF-100 (supplied with the printer).
- Bubble Jet Printers (PIXMA series/SELPHY DS series)
 - *Canon Direct Print* Compatible Printers:
Please refer to your Bubble Jet printer user guide.
 - *PictBridge* Compliant Printers:
Interface Cable IFC-400PCU (supplied with the camera)
- *PictBridge* Compliant Non-Canon Printers
Interface Cable IFC-400PCU (supplied with the camera)

Please refer to the *System Map* or the *Direct Print User Guide* supplied with the camera for direct print compatible printer information.

Charging the Battery Pack

Use the following procedures to charge the battery pack the first time you use the camera or when the “Change the battery pack” message displays.

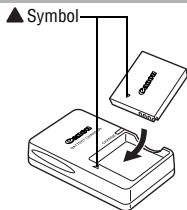

1 Insert the battery pack into the battery charger.

Align the ▲ on the battery pack and battery charger and insert it correctly.

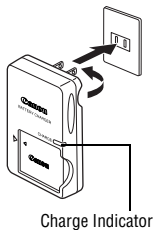

2 Battery charger model names and types vary by region.

(For CB-2LV)

Plug the battery charger into a power outlet.

(For CB-2LVE)

Attach the power cord to the battery charger and plug it into a power outlet.

- The charge indicator will light orange while the battery pack is charging. It will change to green when the charge is complete.
- After charging, unplug the battery charger and immediately remove the battery pack.



To protect the battery pack and prolong its life, do not charge it for longer than 24 hours continuously.



- Since this is a lithium-ion battery pack, you need not completely discharge it before recharging. It can be recharged at any point. However, since the maximum number of charge cycles is approximately 300 times (battery life based on Canon's testing standards), you are recommended to charge the battery pack after having discharged it completely to prolong battery life.
- It takes approximately 90 minutes to fully charge the battery pack from a fully discharged state (based on Canon's testing standards). Charging it within a temperature range of 5° to 40 °C (41° to 104 °F) is recommended.
- Charge times may vary according to the ambient temperature and the battery pack's charge state.
- You may hear a noise during charging. This is not a malfunction.
- See *Battery Capacity (Battery Pack NB-4L (Fully charged))* (p. 162).

Battery Pack Handling Precautions

- Keep the battery pack terminals (\oplus T \ominus) clean at all times. Dirty terminals may cause poor contact between the battery pack and camera. Polish the terminals with a soft cotton swab before charging or using the battery pack.
- Do not rapidly overturn or wave the battery charger around when it contains the battery pack. The battery pack could fly out.
- At low temperatures, battery pack performance may be reduced and the low battery icon may appear earlier than usual. Under these conditions, resuscitate the battery pack by warming it in a pocket immediately before use. However, ensure that there are no metallic items in the pocket that could cause a short circuit, such as a key holder, etc.
- Do not place anything, such as tablecloths, carpets, bedding or cushions, on top of the battery charger while it is charging. Heat will build up and could result in a fire.
- Do not charge batteries other than Battery Pack NB-4L in this charger.
- The battery pack continues to discharge a minimal portion of its power while installed in the camera, even with the power off, or in the charger. This will shorten battery life.

- Do not allow any metal objects such as key rings to touch the \oplus and \ominus terminals (Fig. A), as this can damage the battery pack. To carry the battery pack or store it during periods of disuse, always replace the terminal cover (Fig. B). You may be able to check the charge state when Battery Pack NB-4L is used depending upon how the terminal cover is attached (Fig. C, D).

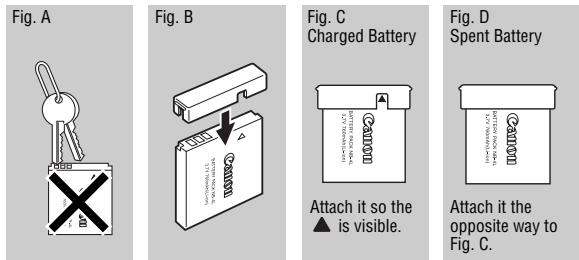

- Even charged battery packs continue to discharge naturally. You are advised to charge the battery on the day of use, or one day before, to ensure a full charge.
- Since storing a fully charged battery pack for long periods of time (about one year) may shorten its life cycle or affect its performance, you are recommended to use it in the camera until it is completely discharged and to store it in an indoor location with low relative humidity and between the temperatures of 0 to 30 °C (32 to 86 °F). If you do not use the battery pack for long periods of time, charge it fully and discharge it fully in the camera about once a year before returning it to storage.
- If the performance of the battery pack diminishes substantially even when it is fully charged, its life has been exceeded and it should be replaced.

Installing the Battery Pack

Install Battery Pack NB-4L (supplied).



Please recharge the battery pack (p. 21) before you use it for the first time.

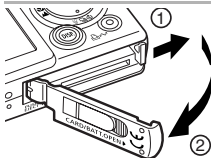

1 Slide the SD card slot/battery cover in the direction of the arrows.

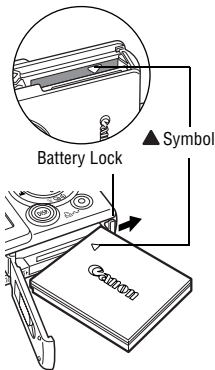

2 Press the battery lock while inserting the battery pack all the way in until the lock clicks.

Align the ▲ on the battery pack and battery chamber and insert it correctly.

To remove the battery pack, press the battery lock in the direction of the arrow and hold it while pulling the battery pack out.

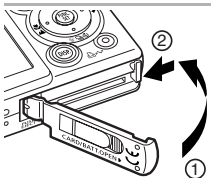

3 Slide the SD card slot/battery cover closed.





- Please watch the loading slot area carefully as you insert and remove the battery pack.
- Do not turn off the power or open the SD card slot/battery cover while the indicator blinks green. The camera is writing, reading, erasing or transmitting an image to or from the SD card.
- Remove the battery pack when the camera is not in use. Please note, however, that the date, time and other camera settings may reset to the default settings if the battery pack has been removed for more than three weeks.



Please use an AC Adapter Kit ACK-DC10 (sold separately) for extended use of the camera (p. 154).

Battery Pack Charge

The following icons and messages will display when the battery pack charge is low.

	<p>Battery pack charge is low. Recharge it as soon as possible before it is required for an extended period.</p> <p>When the LCD monitor is off, this icon will display when you press any button other than the ON/OFF, FUNC./SET, MENU or  (Print/Share) button.</p>
<p>Change the battery pack</p>	<p>Battery charge is insufficient to operate the camera. Replace the battery pack immediately.</p>



See *Battery Capacity (Battery Pack NB-4L (Fully charged))* (p. 162).

Installing the SD Card

Write Protect Tab

The SD card has a write protect tab. Sliding the tab downward prevents recording of data and protects existing data (e.g. images). When recording to, erasing from or formatting the SD card, slide the tab upward.

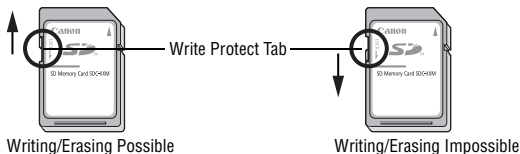

Ensure that the SD card is correctly oriented before inserting it in the camera. It may damage the camera if inserted backward by mistake.

Turn the camera power off and insert the SD card with the following procedures.

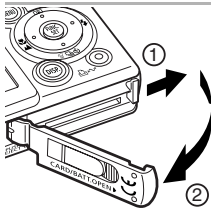

1 Slide the SD card slot/battery cover in the direction of the arrows.

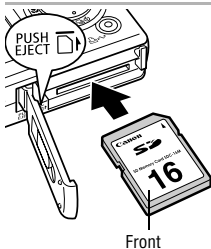

2 Insert the SD card.

- Push it in with your finger or the white portion of the wrist strap, as illustrated on the camera bottom, until it clicks into place.
- Do not touch or allow metal objects to contact the terminals on the back of the SD card.

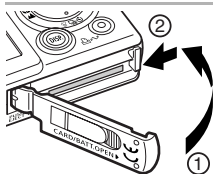

3 Slide the SD card slot/battery cover closed.

To Remove the SD card

Push the SD card with your finger or the toggle on the wrist strap until it clicks and then release it.

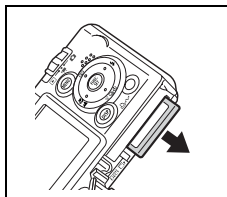
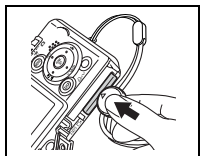
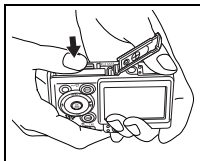

- Please watch the loading slot area carefully as you insert and remove the SD card.
- Since the camera is writing, reading, erasing or transmitting data to or from the SD card when the indicator blinks green, never perform the following actions during this time. It could corrupt the image data.
 - Subject the camera body to vibration or shocks.
 - Turn the camera's power off, or open the SD card slot/battery cover.
- Please note that SD cards formatted with other manufacturers' cameras or a computer, or formatted or edited with application programs, may slow down writing to the SD card or may not operate correctly in the camera.
- You are recommended to use SD cards that have been formatted in your camera (p. 28). The card supplied with the camera may be used without further formatting.



See *SD Cards and Estimated Capacities* (p. 160).

Formatting SD Cards

You should always format a new SD card or one from which you wish to erase all images and other data.



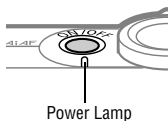

Please note that formatting (initializing) an SD card erases all data, including protected images and other file types.



1 Press the ON/OFF button until the power lamp lights green.



2 Press the MENU button.

The  (Rec.) or  (Play) menu is displayed.



3 Use the → button to select the  (Set up) menu.

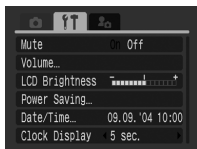

4 Use the ↑ or ↓ button to select [Format] and press the FUNC./SET button.

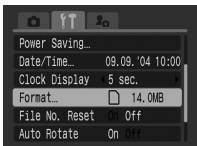

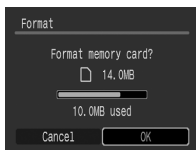

5 Use the → button to select [OK] and press the FUNC./SET button.

- To exit instead of formatting, select [Cancel].
- The capacity of the SD card displayed after formatting will be less than the rated capacity of the SD card. This is not a malfunction of the SD card or camera.



- When the camera is malfunctioning, a corrupted SD card might be the cause. Reformatting the SD card may solve the problem.
- When a non-Canon brand SD card is malfunctioning, reformatting it may solve the problem.
- SD cards formatted in other cameras, computers, or peripheral devices may not operate correctly in this camera. When that happens, reformat the SD card with this camera. If formatting in the camera does not work properly, turn the camera off and re-insert the SD card. Then turn the camera back on and format again.

SD Card Handling Precautions

- SD cards are high-precision electronic devices. Do not bend them, apply force to them, or subject them to shocks or vibration.
- Do not attempt to disassemble or alter the SD card.
- Do not allow dirt, water or foreign objects to contact the terminals on the back of the card. Do not touch the terminals with your hands or metal objects.
- Do not peel away the original label on the SD card or cover it with another label or sticker.
- When writing on the SD card, use a soft point pen (e.g. felt-tip pen). Using a sharp point pen (e.g. ball-point pen) or pencil may damage the SD card or corrupt the recorded data.
- Since some or all of the data recorded on the SD card may be corrupted or erased by electrical noise, static electricity or card malfunction, making a backup copy of important data is recommended.
- Moving an SD card rapidly between temperature extremes will cause condensation to form in the card and lead to a malfunction. To avoid condensation, place the SD card in a sealed plastic bag before moving it into a different temperature zone and allow it to adjust slowly to the new temperature.
- If condensation forms on the SD card, store it at room temperature until the water droplets have evaporated naturally.
- Do not use or store SD cards in the following locations.
 - Locations subject to dust or sand
 - Locations subject to high humidity and high temperatures

Precaution for Multi Media Cards

This camera is designed to perform optimally when used with genuine Canon-brand SD cards. You may use multi media cards (MMC) with this camera. However, Canon makes no warranties concerning the use of multi media cards (MMC).

Setting the Date and Time

The Date/Time menu will appear the first time the camera power is turned on or whenever the built-in rechargeable lithium-ion date/time battery charge is low. Start from Step 5 to set the date and time.





Power Lamp

- 1 Press the ON/OFF button until the power lamp lights green.





- 2 Press the MENU button.

The  (Rec.) or  (Play) menu is displayed.

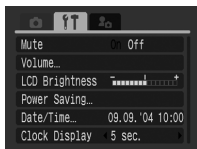

- 3 Use the  button to select the  (Set up) menu.



- 4 Use the  or  button to select [Date/Time] and press the FUNC./SET button.

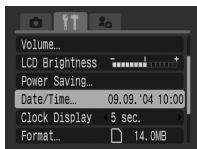



5 Set the date and time.

- Use the ← or → button to select a field (year, month, day, hour, minute and date format).
- Use the ↑ or ↓ button to change its value.



6 Press the FUNC./SET button.

The setting is complete.



7 Press the MENU button.

The display will return to the shooting or playback screen.



- Please note that the date and time settings may reset to the default settings if the camera battery has been removed for more than three weeks. Reset them when this occurs.
- For embedding the date on the image data, refer to page 75.
- To set the camera so that the date and time will not appear on the image when it is being shot but only when it is printed, see *Setting the Print Style* (p. 128), the *Direct Printer User Guide* or the *Canon Digital Camera Software Starter Guide Disk* supplied with the camera.



Charging the Date/Time Battery

- The camera has a built-in rechargeable lithium-ion battery for saving settings such as the date and time. This battery is recharged by the battery pack while it is in the camera. Right after purchasing the camera, leave a charged battery pack in the camera, or plug in AC Adapter Kit ACK-DC10 (sold separately), for about 4 hours to charge the date/time battery. It will charge even when the camera power is turned off.
- If the Date/Time menu appears when the camera power is turned on, the date/time battery charge is low. Use the above method to recharge it.

Using the Clock

You can display the current date and time for a 5-second* interval using the following methods. This is convenient for confirming the shooting date and time.

* Default setting

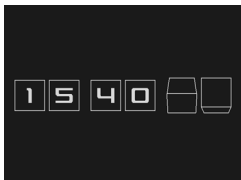

Depending on the camera model, the display may vary slightly.

- **Holding the FUNC./SET Button While Pressing the ON/OFF Button**

- The start-up image will not display at startup, also the start-up sound will not play.
- The Date/Time menu will display if the time has not been set.
- The Display Off function will not work while the clock display is on.

- **Pressing and Holding the FUNC./SET Button in Shooting Mode**

The clock display will differ according to the camera orientation.

- Camera held horizontally: only the time displays
- Camera held vertically: both the time and date display

While the clock display is on, you can change the display color by pressing the **←** or **→** button or by firmly holding and gently shaking the camera as shown in the illustration. Feel free to change to your preferred color.

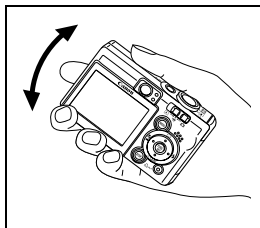

The clock display will cease when the display interval is over or when you operate any one of the **FUNC./SET**, **MENU** or Shutter buttons or the mode switch.

- The clock cannot be displayed when menus are displayed with the **MENU** button.
- The clock's display interval can be changed in the **fn** (Set up) menu (p. 55).

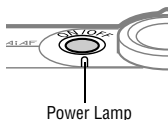

Setting the Language

Use this feature to select the language for the LCD monitor display.



1 Press the **ON/OFF** button until the power lamp lights green.



2 Press the **MENU** button.
The  (Rec.) or  (Play) menu is displayed.



3 Use the **→** button to select the  (Set up) menu.

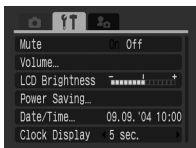

4 Use the **↑** or **↓** button to select [Language] and press the **FUNC./SET** button.

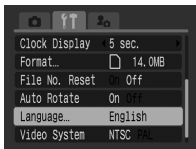



English	Norsk	Polski
Deutsch	Svenska	Čeština
Français	Español	Magyar
Nederlands	简体中文	Türkçe
Dansk	Русский	繁體中文
Suomi	Português	한국어
Italiano	Ελληνικά	日本語



5 Use the **↑**, **↓**, **←** or **→** button to select a language and press the **FUNC./SET** button.



6 Press the **MENU** button.

The display will return to the shooting or playback screen.



The Language menu can also be displayed in Playback mode by holding down the **FUNC./SET** button and pressing the **MENU** button. This function cannot be used while a movie clip is played back, or a separately sold printer is connected to the camera.

Turning the Power On

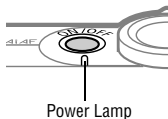

Press the **ON/OFF** button until the indicator lights green.

- The lens extends when the mode switch is set to or .
- The LCD monitor will turn on when the mode switch is set to or (in mode, the indicator beside the viewfinder will blink green).

To Turn the Power Off

Press the **ON/OFF** button again.



- If the "Card locked!" message appears right after the power is turned on, the SD card cannot record (p. 26).
- The Date/Time menu will appear the first time the camera power is turned on or whenever the built-in rechargeable lithium-ion battery charge is low. Reset the date and time when this occurs (p. 31).
- If the power saving function activates, press the **ON/OFF** button to restore power.
- You will hear a start-up sound and see the start-up image when the power is turned on. To change the start-up sound and image, see pp. 54, 57, 142.
- The start-up image does not display when the camera is connected to a TV via the A/V OUT terminal.

Turning On the Power without the Start-Up Sound

Hold the **MENU** button while pressing the **ON/OFF** button. This will set the [Mute] setting to [On] and silence the operation sound and the shutter sound. This is convenient when you wish to shoot silently.

Power Saving Function

This camera is equipped with a power saving function.

When this function is turned on and it activates, restore power by pressing the **ON/OFF** button.

Shooting Mode: Powers down approximately 3 minutes after the last control is accessed on the camera.
The LCD monitor automatically turns off 1 minute* after the last control is accessed even if [Auto Power Down] is set to [Off]. Press any button other than the ON/OFF button or change the camera orientation to turn the LCD monitor back on.

* This time can be changed (p. 55).

Playback Mode: Powers down approximately 5 minutes after the last control is accessed on the camera.

Connected to a Printer (sold separately):

Powers down approximately 5 minutes after the last control is accessed on the camera.

- The power saving function will not activate during a slide show or while the camera is connected to a computer.
- The power saving function can be turned off (p. 55).

Switching Between Shooting/Playback

The mode switch is used to select Shooting and Playback modes.

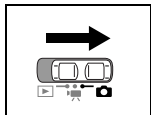

To Shoot Still Images (Shooting Mode)

Slide the mode switch to .

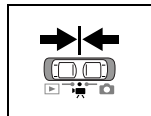



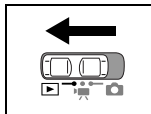

To Shoot Movies (Movie Mode)

Slide the mode switch to .





To Play Back Images (Playback Mode)

Slide the mode switch to .

- The lens retracts approximately 1 minute after changing the mode switch position from  or  to .
- When a printer is connected, images can be printed (see the *Direct Print User Guide*).
- When a camera is connected, recorded images can be downloaded to and viewed with a computer (p. 133).



- When a printer is properly connected, the ,  or  icon appears on the LCD monitor.

Using the LCD Monitor

The LCD monitor can be used to compose images while shooting, adjust menu settings and play back recorded images. Icons showing the camera's status and setting contents appear on the LCD monitor.



The image in the LCD monitor will darken in strong sunlight or bright light. This does not constitute a malfunction.

Shooting Mode (📷, 🗣️)



Press the DISP. button.

The display mode changes as follows with each press.

Standard (No Information)



Detailed (Information View)



- The LCD monitor setting (On or Off) is saved by the camera when the power is turned off so that the same setting is automatically available when the power is turned on again. However, the setting may be lost when the power has been turned off after the “Change the battery pack” message has displayed, while the LCD monitor was on in Shooting mode.
- In the 🗣️ mode, the LCD monitor turns on regardless of its On/Off setting.

Playback Mode (▶)

When the mode switch is set to ▶, the LCD monitor will turn on.



Press the DISP. button.

The display mode changes as follows with each press.

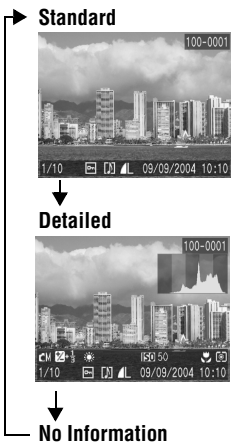

In index playback mode (p. 105), the detailed display is not available.



Information Displayed on the LCD Monitor

When shooting or playing back images, the shooting information, review information or replay information appears on the LCD monitor.

Shooting Information (Shooting Mode)

When setting the flash, continuous mode, self-timer, macro mode, infinity mode, or the metering method, the shooting information displays on the LCD monitor for approximately 6 seconds even if the LCD monitor is set to Standard (No Information) or Off. It may not display under some circumstances, depending on the selected settings.



A slow shutter speed has likely been selected because of insufficient lighting if the upper indicator beside the viewfinder blinks orange after the metering preparations are complete and the camera shake icon  appears in the LCD monitor. Set the flash to  or , or affix the camera to a tripod to shoot.



- Right after a shot is taken, the image and its information appear in the LCD monitor for 2 seconds (or for the number of seconds selected if the review time was changed (2 - 10 sec.)) even if you release the shutter button (p. 61). If you continue to press the shutter button right after shooting an image, or press the **FUNC./SET** button while the image is displayed, the image will continue to display.
- While a recorded image is displayed on the LCD monitor, you can check the exposure with the graph (see *Histogram Function* p.44) that shows the distribution of the brightness data. If the exposure requires adjustment, set the exposure compensation and reshoot. Press the **DISP.** button if the histogram and other information are not shown.

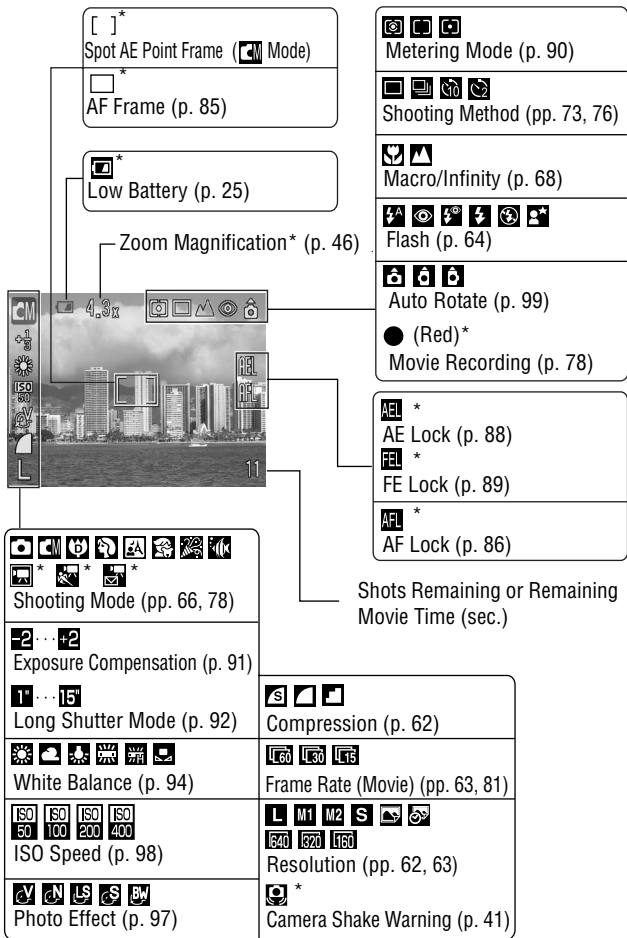

* Appears even if the LCD monitor is set to Standard (No Information).

Zoom powers indicate the combined optical and digital amount of zoom. These figures appear when the digital zoom is activated.

Playback Information—Standard (Playback Mode)

File Number

Image Number — 1/10 — Shooting Date/Time

Protection Status (p. 118)

WAVE Format Sound (p. 113)

Resolution (Still Images) (p. 62)
AVI
Movie (p. 106)

Compression (Still Images) (p. 62)

Playback Information—Detailed (Playback Mode)

Histogram

Shooting Mode (pp. 66, 78, 82)

Exposure Compensation (p. 91)

Long Shutter Mode (p. 92)

Flash (p. 64)

Macro/Infinity (p. 68)

Metering Mode (p. 90)

Movie Length Shown on Movie Files (p. 78)

White Balance (p. 94)





Photo Effect (p. 97)

ISO Speed (p. 98)

Resolution (Movies) (p. 63)

Frame Rate (Movie) (pp. 63, 81)

The following information may also be displayed with some images.

	A sound file in a format other than the WAVE format is attached or the file format is not recognized.
	JPEG file with format not conforming to Design rule for Camera File System Standards
	RAW format file
	File with unrecognized format



Please note that image information recorded by this camera may not display correctly on other cameras and image information recorded by other cameras may not display correctly on this camera.

Histogram Function

The histogram is a graph that allows you to judge the brightness of the shot image. The greater the bias toward the left in the graph, the darker the image. The greater the bias toward the right, the brighter the image. If the image is too dark, adjust the exposure compensation to a positive value. Similarly, adjust the exposure compensation to a negative value if the image is too bright (p. 91).

Sample Histograms



Dark Image



Balanced Image



Bright Image

Using the Viewfinder

The viewfinder can be used to conserve power by turning the LCD monitor off (p. 39) while shooting.

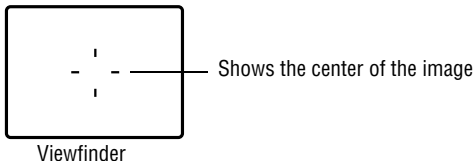

Image Seen in Viewfinder vs. Recorded Image

Usually the recorded image contains more of the scene than is seen in the viewfinder. Confirm the actual image size with the LCD monitor. The image recorded may differ from what is seen in the viewfinder due to the distance between the viewfinder and lens (especially with close-ups). If you use the viewfinder to take close-up shots, portions of the close-up subject may not appear in the recorded image. Use the LCD monitor when taking close-up shots.

About the Autofocus Function

This camera employs AiAF (artificial intelligence autofocus) technology which uses a broad metering field to calculate the focal distance with high precision. It delivers a crisp focus even when the photographic subject is slightly off-center.

The AiAF function can be turned off so that the autofocus is metered from a fixed AF frame at the center of the field (p. 85).



Using the Zoom

The zoom can be adjusted from 35 mm to 105 mm in 35mm film equivalent terms.

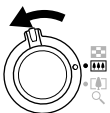
Telephoto/Wide Angle



1 Press the zoom lever toward or .

- Press the zoom lever toward  to zoom in (telephoto).
- Press the zoom lever toward  to zoom out (wide angle).

Digital Zoom

When the LCD monitor is on, you can shoot with a combined optical and digital zoom up to approximately 11x with the DIGITAL IXUS 40 and 10x with the DIGITAL IXUS 30 (p. 72).



The digital zoom is unavailable in some modes (p. 176).



Images become coarser the more they are digitally zoomed.

Pressing the Shutter Button

The shutter button features a two-stage action.

1. Pressing Halfway

Pressing halfway automatically sets the exposure, focus and white balance.

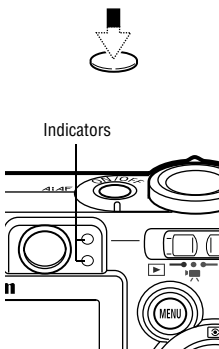

Press the shutter button halfway.

● Beep

- Focused: 2 beeps
- Focusing difficulty: 1 beep

● Indicator Status

Upper Indicator

- Green: Metering complete
- Orange: Flash will fire
- Blinking Orange: Camera shake warning/
Insufficient exposure

Lower Indicator

- Yellow: Macro mode/Infinity mode/AF lock (p.68, 86)
- Blinking Yellow: Focusing difficulty*

* Use the focus lock or AF lock to shoot when the indicator blinks yellow (p. 86).

● AF Frame Status (LCD Monitor On)

AiAF On (p. 85)

- Green Frame: Metering complete (focused AF frame)
- No Frame: Focusing difficulty

AiAF Off (p. 85) (Center AF Frame)

- Green Frame: Metering complete
- Yellow Frame: Focusing difficulty

2. Pressing Fully

Pressing the shutter button down fully activates the shutter and causes the shutter sound to play.





Press the shutter button fully.

While the image is being recorded to the SD card, the indicator blinks green.



Shots cannot be taken while the flash is charging.

AF-assist Beam

- The AF-assist Beam will sometimes emit when the shutter button is pressed halfway to assist focusing in certain conditions, e.g., dark conditions.
- The AF-assist Beam can be turned off (p. 53).
For example, if animals are your subject, turn off the beam when shooting in the dark to avoid startling them.
However, please keep in mind the following facts.
 - Turning the AF-assist Beam off or shooting in dark places may make it more difficult for the camera to focus.
 - The red-eye reduction lamp may emit when the flash is set to  or  even if the AF-assist Beam is turned off.

Selecting Menus and Settings

Menus are used to adjust shooting and playback settings, as well as other camera settings like the Date/Time and sounds. Menus are displayed by pressing the **FUNC./SET** or **MENU** button according to the circumstances. Use the following procedures to select settings.

Selecting Menu Settings with the FUNC./SET Button (Shooting Mode only)

	<p>1 Slide the mode switch to (Shooting) or (Movie).</p>
	<p>2 Press the FUNC./SET button.</p>
	<p>3 Use the or button to select an item.</p> <p>Please see the <i>FUNC. Menu</i> topic on the next page for the selectable menu items.</p>
	<p>4 Use the or button to select an option.</p> <ul style="list-style-type: none"> • Some menu items allow you to make further settings by pressing the MENU button. • You can shoot right after performing these steps. The menu displays again after the shot, allowing you to change the settings easily.
	<p>5 Press the FUNC./SET button.</p>

FUNC. Menu

 Shooting Mode (p. 66)



 Movie Mode (p. 78)



 Exposure Compensation (p. 91)



 Long Shutter Mode (p. 92)

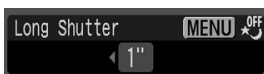

 White Balance (p. 94)



 ISO Speed (p. 98)



 Photo Effect (p. 97)

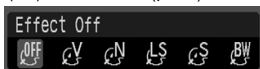

 Compression (p. 62)



 Frame Rate (p. 81)



 Resolution (p. 62)



 Resolution (Movie) (p. 63)



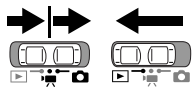

() Items in parentheses show default settings.

Selecting Menu Settings with the MENU Button



1

Slide the mode switch to  (Shooting),  (Movie) or  (Playback).



2 Press the MENU button.

In Shooting mode, the (Rec.) menu appears.

In Playback mode, the (Play) menu appears.



3 Use the or button to select the Rec./Play, Set up, or My Camera menu.

- Select the menu with the / , or icon in the upper left corner of the LCD monitor selected.
- The zoom lever lets you select the menu even if the / , or icon is not selected.



4 Use the or button to select an item.

See *Menu Settings and Factory Defaults* (p. 53).



5 Use the or button to select an option.

Menu items followed by an ellipsis (...) can only be selected after pressing the **FUNC./SET** button to display the next menu. Press the **FUNC./SET** button again to confirm the setting.



6 Press the MENU button.

- The menu will close.
- In Shooting mode, the menu can be closed by pressing the shutter button halfway.



See *Setting the DPOF Print Settings* for the procedures for the (Print Order) item in the Play menu.

Shooting Mode

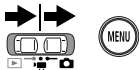

Playback Mode



Rec. Menu



(The menu will appear slightly different depending on the Shooting mode)

Play Menu

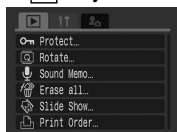

Set up Menu

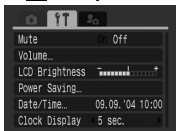

My Camera Menu



- When the My Camera menu is displayed, pressing the button displays the Rec./Play menu.
- When the Rec./Play menu is displayed, pressing the button displays the My Camera menu.

Shooting Mode

Playback Mode

: Selects items.





: Selects options.

Menu Settings and Factory Defaults







This chart shows the options and default settings for each menu.

* Default setting



Rec. Menu

Menu Item	Options	Reference Page
AiAF	Sets whether or not the camera automatically selects the AF frame or a fixed center AF frame. <ul style="list-style-type: none">• On*• Off	p. 85
Self-timer	Sets the duration of the self-timer delay. <ul style="list-style-type: none">•  10 seconds*•  2 seconds	p. 76
AF-assist Beam	Sets the AF-assist Beam to on or off. <ul style="list-style-type: none">• On*• Off	p. 48
Digital Zoom	Sets the digital zoom to on or off. <ul style="list-style-type: none">• On• Off*	p. 72
Review	Sets the duration images display on the LCD monitor after the shutter button releases. <ul style="list-style-type: none">• Off• 2* to 10 seconds	p. 60
Date Stamp	Sets the date stamp for postcard prints with embedded date stamps. <ul style="list-style-type: none">• Off*• Date• Date & Time	p. 75
Long Shutter	Sets the shutter speed to slow settings. <ul style="list-style-type: none">• On• Off*	p. 92
Stitch Assist	Images are shot in overlapping series to create single panoramic images. <ul style="list-style-type: none">•  Left to right*•  Right to left	p. 82

Play Menu

Menu Item	Options	Reference Page
 Protect	Protects images from accidental erasure.	p. 118
 Rotate	Rotates images clockwise 90° or 270° in the display.	p. 111
 Sound Memo	Adds sound memos to images.	p. 112
 Erase all	Deletes all images from an SD card (except for protected images).	p. 120
 Slide Show	Plays images automatically one after the other.	p. 114
 Print Order	Selects images and the number of print copies for output to a direct print compatible printer or photo developing service.	p. 124
 Transfer Order	Specifies settings for images before downloading to a computer.	p. 130

Set up Menu



Menu Item	Options	Reference Page
Mute	Set to [On] to silence the start-up, shutter, operation and self-timer sounds all at once. See <i>How the [Mute] option in the  (Set up) Menu and Sounds in the  (My Camera) Menu Interact (p. 57).</i> <ul style="list-style-type: none"> • On • Off* (Still beeps to warn of an error even when set to [On].)	–
Volume	Adjusts the volume of the start-up sound, operation sound, self-timer sound, shutter sound and playback sound. The volume cannot be adjusted if [Mute] is set to [On]. <div style="text-align: center; margin-top: 10px;">  </div>	–
Start-up Vol.	Adjusts the volume of the start-up sound when the camera power is turned on.	p. 36

Menu Item	Options	Reference Page
Operation Vol.	Adjusts the volume of the operation sound that beeps when any button other than the shutter button is pressed.	–
Selftimer Vol.	Adjusts the volume of the self-timer sound played 2 sec. before the shutter is released.	p. 76
Shutter Volume	Adjusts the volume of the sound played when the shutter releases. The shutter sound does not play when a movie is recording.	p. 47
Playback Vol.	Adjusts the volume of movie sounds and sound memos.	p. 106 p. 112
LCD Brightness	Adjusts the LCD brightness of the LCD monitor. • -7 to 0* to +7 Use the ◀ or ▶ button to adjust the brightness. If you press the ▲ or ▼ button, the display returns to the Set up menu. You can check the brightness in the LCD monitor while you are adjusting the setting.	–
Power Saving	Sets the [Auto Power Down] and [Display Off] options.	
Auto Power Down	Sets whether or not the camera automatically powers down after a set period of time elapses without something being pressed. • On* • Off	p. 37
Display Off	Sets the length of time before the LCD monitor turns off when no camera operation is performed. • 10 sec. • 20 sec. • 30 sec. • 1 min.* • 2 min. • 3 min.	
Date/Time	Sets the date and time and the date format.	p. 31
Clock Display	Sets the length of time for which the clock displays. • 0 – 5* – 10 sec. • 20 sec. • 30 sec. • 1 min. • 2 min. • 3 min.	p. 33
Format	Formats (initializes) SD cards.	p. 28











Menu Item	Options	Reference Page
File No. Reset	Sets how file numbers are assigned to images when new SD cards are inserted. <ul style="list-style-type: none"> • On • Off* 	p. 100
Auto Rotate	Sets whether or not images shot with the camera held vertically are automatically rotated in the display. <ul style="list-style-type: none"> • On* • Off 	p. 99
Language	Sets the language used in menus and messages on the LCD monitor. <ul style="list-style-type: none"> • English* • Deutsch (German) • Français (French) • Nederlands (Dutch) • Dansk (Danish) • Suomi (Finnish) • Italiano (Italian) • Norsk (Norwegian) • Svenska (Swedish) • Español (Spanish) • 简体中文 (Simplified Chinese) • Русский (Russian) • Português (Portuguese) • Ελληνικά (Greek) • Polski (Polish) • Čeština (Czech) • Magyar (Hungarian) • Türkçe (Turkish) • 繁體中文 (Traditional Chinese) • 한국어 (Korean) • 日本語 (Japanese) <p>You can also change the language in Playback mode by holding the FUNC./SET button and pressing the MENU button.</p>	p. 34
Video System	Sets the video output signal standard. <ul style="list-style-type: none"> • NTSC • PAL 	p. 141

My Camera Menu

You can select the start-up image and sound, operation sound, self-timer sound and shutter sound used on this camera.

These are called the My Camera settings. You can also customize the  and  options for each item with images recorded on the SD card and newly recorded sounds or by using the supplied software.

See the *Canon Digital Camera Software Starter Guide Disk* for details.

Menu Item	Available Settings	Reference Page
 Theme	Selects a common theme for each My Camera settings item.	p. 142
 Start-up Image	Sets the image displayed when the camera power is turned on.	
 Start-up Sound	Sets the sound played when the camera power is turned on.	
 Operation Sound	Sets the sound played when any button other than the shutter button is pressed.	
 Selftimer Sound	Sets the sound played 2 seconds before the shutter releases in self-timer mode.	
 Shutter Sound	Sets the sound played when the shutter button is pressed. There is no shutter sound for movies.	
My Camera Menu Contents	<ul style="list-style-type: none"> •  (Off) •  •  * •  	

• How the [Mute] option in the (Set up) Menu and Sounds in the (My Camera) Menu Interact

To turn off each sound, such as the start-up sound, shutter sound, operation sound and self-timer sound, [Mute] must first be set to [On] in the  (Set up) menu. When [Mute] is set to [On], each sound option will not play even if they are set individually to [On]. The warning sound, however, will play even when [Mute] is set to [On].

Resetting Settings to Their Default Values

You can reset the menu and button settings to the default settings in one operation.



Power Lamp

1 Press the ON/OFF button.

Set the mode switch to any position.



2 Press and hold the MENU button for more than 5 seconds.



3 Use the ← or → button to select [OK] and press the FUNC./SET button.

To exit without resetting, select [Cancel].

Default settings

Reset settings to default?

Cancel

OK



- Settings cannot be reset when the camera is connected to a computer or to a printer.
- The following cannot be reset.
 - Shooting mode
 - The Date/Time, Language and Video System options in the  (Set up) menu (p. 55, p. 56)
 - White balance data recorded with the custom white balance function (p. 94)
 - Newly added My Camera settings (p. 144)









Shooting in Auto Mode

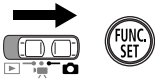

Shooting Mode

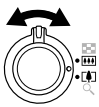

In this mode, all you have to do is press the shutter button and let the camera do everything else.

- | | |
|---|---|
|   | <p>1 Slide the mode switch to  (Shooting). In the FUNC. menu, select  (Auto).</p> <ul style="list-style-type: none"> • See <i>Selecting Menus and Settings</i> (p. 49). • You can shoot right after selecting an option. The menu displays again after the shot, allowing you to change the settings easily. |
|  | <p>2 Press the FUNC./SET button.</p> <p>The display will return to the shooting screen and  will appear on the LCD monitor.</p> |
| | <p>3 Aim the camera at the subject.</p> |
|  | <p>4 Use the zoom lever to achieve the desired composition (relative subject size in the viewfinder) (p. 46).</p> |
|  | <p>5 Press the shutter button halfway (p. 47).</p> <ul style="list-style-type: none"> • Two beeps will play when the camera has finished metering, and the upper indicator beside the viewfinder will light green or orange. If the LCD monitor is on, the AF frame will appear green. • If the subject is difficult to focus on, the lower indicator beside the viewfinder will blink yellow and the beep will play one time. |



6 Press the shutter button fully (p. 48).

- You will hear the sound of the shutter when the shutter activates.
- The picture appears for two seconds on the LCD monitor.



- See *Functions Available in Each Shooting Mode* (p. 176).
- With the Review function, you can change the length of time images show on the LCD monitor after shooting, or set it so they do not show at all (p. 60).

Reviewing an Image Right after Shooting

Shooting Mode



Right after a shot is taken, the image appears in the LCD monitor for 2 seconds. In addition, the images will keep on displaying regardless of the review duration setting if one of the following operations is performed.

- **Keeping the shutter button pressed after a shot.**
- **Pressing the FUNC./SET button while the image is displayed on the LCD monitor (except in  mode).**

Press the shutter button halfway to stop displaying it so that you can shoot the next frame.



- You can do the following while the image is displayed (except in  mode).
 - Display the image's information (p. 41).
 - Erase the image (p. 119).
 - After pressing the **FUNC./SET** button, magnify the image (p. 104).

Changing the Review Duration

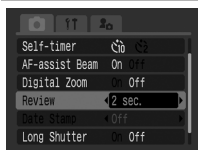

The default review time is 2 seconds. The review function can be set to [Off] or changed to any time in the range of 2 to 10 seconds in one-second increments.



1 In the  (Rec.) menu, select [Review].

See *Selecting Menus and Settings* (p. 49).



2 Use the  or  button to select the review setting and press the MENU button.



- With the [Off] option, the image will not automatically display.
- In the [2 sec.] to [10 sec.] range, the image will continue to display for the specified time even if the shutter button is released.







Changing Resolution/Compression Settings

Shooting Mode



You can change the compression (excluding movies) and resolution settings to suit the purpose of the image you are about to shoot.





Resolution		Purpose	
L (Large)** 2272 x 1704 pixels <hr/> 2048 x 1536 pixels <hr/> M1 (Medium 1) 1600 x 1200 pixels <hr/> M2 (Medium 2) 1024 x 768 pixels <hr/> S (Small) 640 x 480 pixels	High   Low	<ul style="list-style-type: none"> • Print larger than A4-size prints* 210 x 297 mm (8.3 x 11.7 in.) • Print larger than Letter-size prints* 216 x 279 mm (8.5 x 11 in.) • Print up to A4-size prints* 210 x 297 mm (8.3 x 11.7 in.) • Print up to Letter-size prints* 216 x 279 mm (8.5 x 11 in.) • Print postcard-size prints 148 x 100 mm (6 x 4 in.) • Print L-size prints 119 x 89 mm (4.7 x 3.5 in.) • Send images as e-mail attachments • Shoot more images 	
	  (Postcard Date Imprint Mode) 1600 x 1200 pixels		<ul style="list-style-type: none"> • The resolution is set to M1 (1600 x 1200) and the compression to  (Fine). • See <i>Postcard Date Imprint Mode</i> (p. 74).

* Paper sizes vary according to region.











The resolution at the **L (Large) setting is as follows:

DIGITAL IXUS 40: 2272 x 1704 pixels

DIGITAL IXUS 30: 2048 x 1536 pixels

Compression		Purpose
 Superfine	High Quality   Normal	• Shoot higher quality images
 Fine		• Shoot normal quality images
 Normal		• Shoot more images

Movies can be shot with the following resolutions.

	Resolution	Frame Rate		
		 frames/sec.	 frames/sec.	 frames/sec.
 Standard	 640 x 480 pixels	–	○	○
	 320 x 240 pixels	–	○	○
 Fast Frame Rate	 320 x 240 pixels	○	–	–
 Compact	 160 x 120 pixels	–	–	○

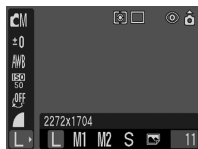



1 In the FUNC. menu, select  * or  *.

See *Selecting Menus and Settings* (p. 49).

* The current setting is displayed.



2 Use the  or  button to select an option.

- For movies, see page p.78.
- You can shoot right after selecting an option. The menu displays again after the shot, allowing you to change the settings easily.



3 Press the FUNC./SET button.

The display will return to the shooting screen.



- See *Image File Sizes (Estimated)* (p. 161).
- See *SD Cards and Estimated Capacities* (p. 160).

⚡ Using the Flash



Shooting Mode



Use the flash according to the guidelines below.

	Auto	The flash fires automatically as required by the light level.
	Auto with red-eye reduction	The flash fires automatically as required by the lighting level, and the red-eye reduction lamp fires each time the main flash fires.
	Flash on with red-eye reduction	The flash and red-eye reduction lamp fire with each shot.
	Flash on	The flash fires with every shot.
	Flash off	The flash will not fire.
	Slow Synchro	The flash timing is adjusted to slow shutter speeds. This reduces the chance that the background will be dark when shots are taken at night or in rooms with artificial lighting. The red-eye reduction lamp fires with each shot. Use of a tripod is recommended.

	○	○	—	○	○	○	○	○	○	—
	○	○	—	○	○	○	○	○	○	—
	—	—	—	○	○	○	○	○	○	—
	—	○	—	○	○	○	○	○	○	△
	○	○	○	○	○	○	○	○	○	△
	—	○	—	—	—	—	—	—	—	△

○ Setting available △ Can be selected for the first image only



1 Press the ⚡ button to switch between flash modes.

The selected flash mode appears on the LCD monitor.





- When you use flash photography at higher ISO speeds, the chances of white streaks appearing in the image increase the closer you approach to the subject.
- Since a slow shutter speed is selected in dark places when the flash is set to Off or Slow Synchro, take care to avoid camera shake.
 - Shooting in , , , , or mode
Be careful to hold the camera still to avoid camera shake.
 - Shooting in , or mode
Fix the camera to a tripod to shoot in these modes since the shutter speed will be slower than in the mode.



- The flash can be fired when the indicator lights a steady orange after pressing the shutter button halfway.
- The flash may take up to approximately 10 seconds to charge. The recharging time will vary with such factors as the shooting conditions and battery charge. Shots cannot be taken while the flash is charging.
- The flash fires twice. The main flash follows a pre-flash. The exposure reading obtained from the subject with the pre-flash is used to set the optimal flash intensity for the main flash, which is used to capture the image.
- When using the flash for standard photography, be sure to shoot from a distance of at least 50 cm (1.6 ft.) away from your subject.

Red-Eye Reduction

- Light reflecting back from eyes can make them appear red when the flash is used in dark areas. Under these conditions, use the red-eye reduction mode. For this mode to be effective, the subject must be looking right at the red-eye reduction lamp. Try asking them to look directly at the lamp. Even better results can be obtained by increasing the lighting in indoor settings or approaching closer to the subject.
- The shutter will not activate for approximately 1 second after the red-eye reduction lamp fires in order to improve the effect (except when shooting in the mode). If you want a more immediate shutter response, set the flash to , or .

Selecting a Shooting Mode



Shooting Mode



You can take an optimal picture simply by selecting the appropriate shooting mode.

	Auto	Leaves almost all of the settings choices up to the camera (p. 59).
	Manual	Lets you adjust the exposure, white balance, photo effect and other settings yourself.
	Digital Macro	You can approach as close as 3 cm (1.2 in.) (minimum focusing distance) to a subject to shoot (p. 70). Since this mode trims all but the image center and magnifies it with the digital zoom, you can make a subject appear even larger than in the normal macro mode.
	Portrait	Produces a soft effect when photographing people.
	Night Snapshot	Use this to take snapshots of people against twilight or night backgrounds to reduce the effects of camera shake even without using a tripod.
	Kids&Pets	Allows you to capture subjects that move around, such as children and pets, without missing photo opportunities.
	Indoor	Prevents camera shake and maintains the subject's true color when shooting under florescent or tungsten lightning. The exposure is regulated so as to avoid the use of flash as much as possible.
	Underwater	Appropriate for shooting images with the All Weather Case AW-DC30 (sold separately). This mode uses an optimal white balance setting to reduce bluish tones and record images with natural hues.

Manual

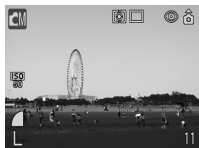

Portrait

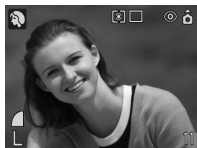

Night Snapshot



Kids&Pets



Indoor



Underwater

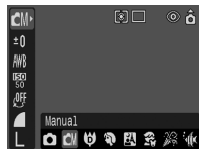





1 Choose a shooting mode from the FUNC. menu.

- See *Selecting Menus and Settings* (p. 49).
- You can shoot right after selecting an option. The menu displays again after the shot, allowing you to change the settings easily.







2 Press the FUNC./SET button.



- The display will return to the shooting screen and the icon of the selected shooting mode will appear on the LCD monitor.
- Except for the  or  mode, the shooting procedures are the same as for *Shooting in Auto Mode* (p. 59).
- See *Magnified Close-Up Shooting (Digital Macro)* (p. 70) for shooting in  mode.
- To shoot in  mode, refer to the *All Weather Case User Guide* that accompanies All Weather Case AW-DC30 (sold separately).



- In , , , and  modes, the ISO speed may increase and cause noise in the image.
- In  mode, shoot with the subject 1 - 4 m (39 in. - 3.3 ft.) (telephoto range zoom settings)/1 m (39 in.) - infinity (non-telephoto range zoom settings) from the end of the lens.



- See *Functions Available in Each Shooting Mode* (p. 176).
- Results may vary depending on the subject.
- In  mode, you are recommended to use the LCD monitor to shoot.
- To shoot underwater, install the camera in All Weather Case AW-DC30 (sold separately).

🌸 Shooting Close-Ups/▲ Infinity Shots



Shooting Mode



	Macro	Use this mode to record subjects in the range of 3 to 50 cm (1.2 in. to 1.6 ft.) from the end of the lens at the maximum wide angle setting and in the range of 30 to 50 cm (1.0 ft. to 1.6 ft.) at the maximum telephoto setting.
	Infinity	Use this mode to record landscapes and distant subjects. It can also be used for compositions combining both near and distant subjects.

	○	○	–	○	○	–	○	○	△	○	
	–	○	–	○	○	–	○	○	△	○	

○ Setting available

△ Can be selected for the first image only

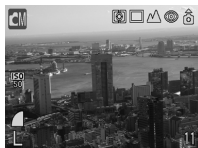

1 Press the 🌸 / ▲ button to select the macro/infinity mode.

The selected macro/infinity mode appears on the LCD monitor.

To cancel the macro/infinity mode

Press the 🌸 / ▲ button to remove or from the display.



- Use the LCD monitor to compose close-ups in macro mode since images composed with the viewfinder may be off-center (p. 45).
- The exposure may not be optimal when the flash is used in macro mode in the range of 3 to 30 cm (1.2 in. to 1.0 ft.).



See *Photo Tips and Information* (p. 164).

Image Area in Macro Mode

When the zoom is set between the maximum telephoto and wide-angle settings, the effective distance from the lens to the subject becomes the same as for the maximum telephoto setting.

Zoom Setting (35mm Film Equivalent)	Distance from Lens to Subject	Image Area
Max. Telephoto	30 cm (1.0 ft.)	108 x 81 mm (4.3 x 3.2 in.)
Max. Wide Angle	3 cm (1.2 in.)	37 x 27 mm (1.5 x 1.1 in.)



4 Use the zoom lever adjust the zoom to achieve the desired composition.



- See *Functions Available in Each Shooting Mode* (p. 176).
- The image area for close-ups at the maximum power of magnification for digital macro is as follows:
 - DIGITAL IXUS 40: Approx. 10.2 to 7.5 mm (0.40 x 0.30 in.).
 - DIGITAL IXUS 30: Approx. 11.4 to 8.5 mm (0.45 x 0.33 in.).

Using the Digital Zoom



Shooting Mode



When the LCD monitor is on, images can be zoomed to the following powers of magnification with the combined optical and digital zoom functions.

DIGITAL IXUS 40: Approx. 4.3x, 5.3x, 6.7x, 8.2x, 11x

DIGITAL IXUS 30: Approx. 3.8x, 4.8x, 6.0x, 7.4x, 10x



The digital zoom cannot be used when the LCD monitor is turned off.



1 Press the DISP. button to turn the LCD monitor on.



2 In the (Rec.) menu, select [Digital Zoom].

See *Selecting Menus and Settings* (p. 49).



3 Use the or button to select [On] and press the MENU button.

The display will return to the Shooting screen.



4 Press the zoom lever toward .

- The combined optical and digital zoom factor appears on the LCD monitor.
- When you press the zoom lever toward , the zoom stops when the lens reaches the maximum optical telephoto setting. Press the zoom lever toward again to activate the digital zoom and further zoom the image digitally.
- Press the zoom lever toward to zoom out.



Images become coarser the more they are digitally zoomed.

Continuous Shooting



Shooting Mode



In this mode, the camera shoots continuously while the shutter button is held down. Recording ceases when the shutter button is released. In addition, under the following conditions, continuous shooting can occur at a consistent interval until the SD card is full.

- A resolution and compression combination other than **L** and **S** is selected.
 - The recommended SDC-512MSH SD card (sold separately) is used.
- * This figure reflects standard shooting criteria established by Canon. Actual figures may vary according to the subject and shooting conditions.
* If continuous shooting suddenly stops, the SD card may be full.



1 Press the button to display .

To Cancel Continuous Shooting

Press the button twice to display .



To enhance the continuous shooting performance when you suspect the speed has dropped, you are recommended to format the SD card in the camera after you save all its images to your computer.



- The interval between shots may lengthen slightly when the camera's built-in memory fills.
- If the flash is firing, the interval between shots will lengthen to accommodate the flash's charging requirements.

Postcard Date Imprint Mode



Shooting Mode



You can shoot images with the optimal resolution and compression for postcard size printing.

- When printing standard image data to postcard size, sometimes the top, bottom and sides may not get printed.
- By shooting images in the Postcard Date Imprint mode, you can check the printing area (horizontal/vertical ratio of 3:2) beforehand. In addition, the resolution locks to **M1** (1600 x 1200) and the compression locks to the (Fine) setting, rendering smaller file sizes.



1 In the FUNC. menu, select *.

- See *Selecting Menus and Settings* (p. 49).
- * The current setting is displayed.



2 Use the or button to select .

You can shoot the image right after selecting settings by pressing the shutter button. The menu displays again after the shot, allowing you to change the settings easily.



3 Press the FUNC./SET button.

- The display will return to the shooting screen and will appear on the LCD monitor.
- When you press the shutter button halfway, the area that will not get printed grays out.



Selecting cancels the digital zoom when it is set to [On].



- The  icon appears in the LCD monitor when the date stamp setting (see below) is set to Date or Date & Time.
- For printing instructions, refer to the *Direct Print User Guide*.

Embedding the Date in the Image Data

You can embed the date in image data when  (Postcard Date Imprint Mode) is selected. The date will be printed on your images even if it has not been set with a computer or printer.



- Ensure that the camera's date/time is set beforehand (p. 31).
- You cannot embed the date in image data when  (Postcard Date Imprint mode) is not selected.

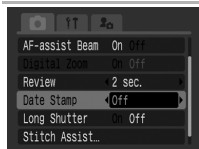

1 In the (Rec.) menu, select [Date Stamp].

See *Selecting Menus and Settings* (p. 49).



2 Use the or button to select [Date] or [Date & Time].

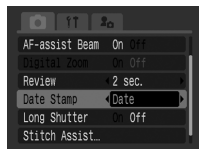

- The display will return to the shooting screen.
- When you do not want to print the date, select [Off].



- The date stamp cannot be deleted from the image data once it has been set.
- A portion of the date may not print when selecting the credit card size print (54 x 86 mm (2.1 x 3.4 in)) to print on a compact photo printer (SELPHY CP series) or card photo printer.

🕒 Using the Self-timer



Shooting Mode



With this function, images are shot 10 or 2 seconds after the shutter button is pressed. This is useful when you want to take a memorable photo with everyone including yourself in the picture. The self-timer can be used in any shooting mode.



1 Press the 🕒 button to display 🕒 or 🕒.

- When the shutter button is pressed fully, the self-timer will activate and the self-timer lamp will blink.
- When the self-timer is set to 🕒 (🕒), the shutter activates 10 (2) seconds after the shutter button is pressed fully.

To Cancel the Self-Timer

Press the 🕒 button to display 🕒.

Changing the Self-timer Countdown Time

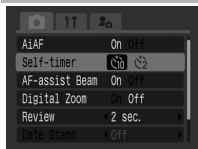

1 In the (Rec.) menu, select [Self-timer].

See *Selecting Menus and Settings* (p. 49).

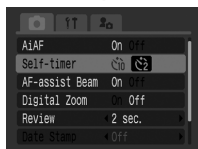

2 Use the or button to select or and press the MENU button.

- The display will return to the shooting screen.
- When is selected, the self-timer sounds and the blinking gets faster 2 seconds before the shutter activates.
- When is selected, the self-timer sounds at the same time as the shutter button is pressed. The shutter activates in 2 seconds.



- The self-timer sound can be changed with the Selftimer Sound item in the (My Camera) menu (p. 57).
- See *Photo Tips and Information* (p. 164).

Shooting a Movie



The following three movie modes are available.

	Standard	You can select the resolution and frame rate* yourself. You can shoot until the SD card becomes full (Using high-speed SD cards (SDC-512MSH recommended)). <ul style="list-style-type: none">• Resolution: (640 x 480), (320 x 240)• Frame Rate: (30 frames/sec.), (15 frames/sec.)
	Fast Frame Rate	Use this mode to record fast moving subjects, such as in sports photography. <ul style="list-style-type: none">• Resolution: (320 x 240)• Frame Rate: (60 frames/sec.)• Max. Clip Length: 1 minute
	Compact	Since the resolution is low, this mode is convenient for sending movies as e-mail attachments or when the SD card capacity is low. <ul style="list-style-type: none">• Resolution: (160 x 120)• Frame Rate: (15 frames/sec.)• Max. Clip Length: 3 minutes

* The frame rate indicates the number of frames recorded/replayed in one second. The higher the frame rate, the smoother the motion.

* The recording time will vary according to the capacity of the SD card you use. See page 160 for details.



1 Slide the mode switch to (Movie).

The maximum recording time (in seconds) is displayed.



2 In the FUNC. menu, select *.

• See *Selecting Menus and Settings* (p. 49).

* The current setting is displayed.



3 Use the ← or → button to select

,  or .

- You can shoot the image right after selecting settings by pressing the shutter button. The menu displays again after the shot, allowing you to change the settings easily.
- In  mode, you can change the resolution (p. 63) and frame rate (p. 81).



4 Press the FUNC./SET button.

The display will return to the shooting screen and the icon of the selected movie mode will appear in the LCD monitor.



5 Press the shutter button fully.

- Shooting and sound recording starts simultaneously.
- During shooting the recording time (in seconds) and a red circle appear on the LCD monitor.







6 Press the shutter button fully again to stop recording.

The maximum recording time may vary with the subject and shooting conditions. Just before the maximum is reached, or just before the SD card fills to capacity, the counter at the bottom right of the LCD monitor will display in red and recording will stop automatically after approximately 10 seconds.





- The recording time may not display properly during shooting or filming may stop unexpectedly with the following types of SD cards.
 - Slow recording cards
 - Cards formatted on a different camera or a computer
 - Cards which have had images recorded and erased repeatedlyAlthough the recording time may not display properly during shooting, the movie will be recorded correctly on the SD card. Recording time will display properly if you format the SD card in this camera (excluding slow recording SD cards).
- You are recommended to use an SD card that has been formatted in your camera to shoot movies (p. 28). The card supplied with the camera may be used without further formatting.
- Be careful not to touch the microphone while recording.
- Do not press buttons other than the shutter button while filming to avoid inadvertent recording of the operation sounds.
- The AF and zoom settings remain fixed for subsequent frames at the values selected for the first frame.
- During filming, the camera will automatically correct the exposure and white balance settings to suit the shooting conditions. Please note, however, that the sounds made by the automatic settings adjustment may also be recorded.
- After a clip is shot, the indicator will blink green while the clip is being written to the SD card. You cannot shoot again until the blinking stops.



- See *Functions Available in Each Shooting Mode* (p. 176).
- Sound is recorded monaurally.
- There is no shutter sound in movie mode.
- You can adjust the exposure compensation setting before shooting. Press the  button to lock the exposure setting (AE lock) and display the exposure compensation bar in the LCD monitor. Use the  or  button to adjust the setting. The exposure compensation setting will cancel if you press the **MENU** button or change the white balance, photo effect or shooting mode.
- The recording time and capacity may vary according to camera usage and SD card performance. If free space in the camera's internal memory becomes too scarce, even if there is surplus recording time or capacity available, the "!" symbol will display at the bottom right of the LCD monitor in red and the camera will automatically cease filming shortly thereafter. If the "!" warning displays frequently, try the following procedures.
 - Reformat the SD card before filming (p. 28)
 - Set the resolution to  (320 x 240) or the frame rate to  (15 frames/sec.)
 - Use a high-speed SD card (SDC-512MSH, etc.)
- QuickTime 3.0 or later is required to play back movie files (AVI/Motion JPEG) on a computer. QuickTime (for Windows) is included on the Canon Digital Camera Solution Disk. On the Macintosh platform, this program is generally bundled with Mac OS 8.5 or later operating systems.

Changing the Frame Rate



In the  (Standard) mode, you can select between one of two frame rates (number of frames recorded each second):  (30 frames/sec.) or  (15 frames/sec.).



1 In the FUNC. menu, select *.

- See *Selecting Menus and Settings* (p. 49).
- * The current setting is displayed.



2 Use the **←** or **→** button to select  or .

You can shoot the image right after selecting settings by pressing the shutter button. The menu displays again after the shot, allowing you to change the settings easily.



3 Press the FUNC./SET button.

The display will return to the shooting screen.

Shooting Panoramic Images (Stitch Assist)

Shooting Mode



Stitch Assist can be used to shoot overlapping images that can later be merged (stitched) to create one panoramic image on a computer.

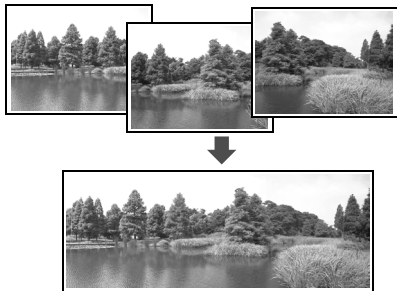

The overlapping seams of several adjacent images can be joined into a single panoramic image.



To merge the images on a computer, use PhotoStitch, one of the supplied programs.

Framing a Subject

The PhotoStitch program detects the overlapping portions of adjoining images and merges them. When shooting, try to include a distinctive item (landmark) in the overlapping portions.





- Compose each frame so that it overlaps 30 - 50% of the adjoining image. Try to keep the vertical misalignment to less than 10% of the image height.
- Do not include moving items in the overlap.
- Do not try to stitch images that include both distant and close items. These items may appear warped or doubled up in the merged image.
- Make the brightness in each image consistent. The final image will appear unnatural if the contrast in brightness is too great.
- To shoot landscapes, swivel (pan) the camera around its own vertical axis.

- To shoot close-ups, slide the camera over the subject, keeping it parallel to the subject as you move it.

Shooting

Images can be shot in two sequences in Stitch Assist mode.

	Left to right horizontally
	Right to left horizontally

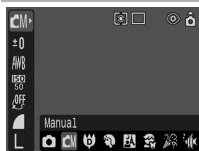

1 In the FUNC. menu select

- See *Selecting Menus and Settings* (p. 49).

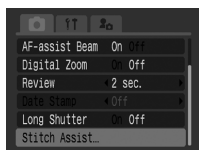

2 In the (Rec.) menu, select [Stitch Assist] and press the FUNC./SET button.

See *Selecting Menus and Settings* (p. 49).



3 Use the or button to select a shooting direction and press the FUNC./SET button.

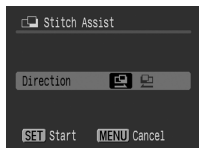



4 Shoot the first frame in the sequence.

The exposure and white balance are set and locked with the first image.



5 Compose the second image so that it overlaps a portion of the first and shoot.

- Use the ◀ or ▶ button to check or retake the recorded images.
- Minor discrepancies in the overlapping portions can be corrected when the images are stitched together.



6 Repeat the procedure for additional images.

A sequence may contain up to 26 images.



7 Press the MENU button after the last shot.

The Stitch Assist session ends. Press the **MENU** button again to return to the shooting screen.



- A custom white balance setting cannot be set in Stitch Assist mode. To use a custom white balance setting, set it before selecting [Stitch Assist] in the Rec. menu (p. 95).
- The settings for the first image are used to take subsequent images in the sequence.
- It is not possible to display images on the TV when shooting in Stitch Assist mode.



See *Functions Available in Each Shooting Mode* (p. 176).

Switching between Focusing Modes



Shooting Mode



Although the autofocus function is preset to the AiAF setting (9 AF frames), you can set it to the center AF frame.

When [AiAF] is set to [On], the AF frame does not appear. When [AiAF] is set to [Off], however, the AF frame will appear.

No frame	On	The camera detects the subject and highlights the AF frames, from 9 available points, that it will use to determine the focus.
<input type="checkbox"/>	Off	The camera focuses using the center AF frame. This is convenient for focusing on a specific part of a subject with greater certainty.

The symbol represents the AF frames as they appear in the LCD monitor.

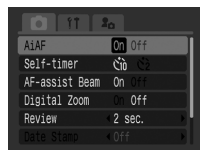

1 In the (Rec.) menu, select [AiAF].

See *Selecting Menus and Settings* (p. 49).



2 Use the or button to select [On] or [Off].

You can shoot right after selecting an option.



3 Press the MENU button.

The display will return to the shooting screen.





The focus is locked to the center AF frame when the digital zoom is used.

Shooting Hard-to-Focus Subjects (Focus Lock, AF Lock)

Shooting Mode



*The AF lock only works in the  or  mode.



It may be difficult to focus on the following types of subjects. Use the focus lock or AF lock in these situations.

- Subjects with extremely low contrast to the surroundings
- Subjects with extremely bright objects at the center of the composition
- Subjects that are moving quickly
- Subjects through glass:







Try to shoot as close to the glass as possible to reduce the chances of light reflecting back off the glass.

- Subjects with horizontal stripes

Shooting with the Focus Lock

	1 Aim the camera so that an object at the same focal distance as the main subject is centered in the viewfinder or in the AF frame displayed on the LCD monitor.
	2 Press the shutter button halfway (two beeps will play). The focal distance to the object is locked.
	3 Re-aim the camera to compose the shot as desired and press the shutter button fully.

Shooting with the AF Lock

	1 Press the DISP. button to turn the LCD monitor on.
	2 Aim the camera so that an object at the same focal distance as the main subject is centered in the AF frame.
 	3 Press the shutter button halfway (two beeps will play) and press the  /  button. <ul style="list-style-type: none"> • The focal distance to the object is locked. • The AF-L icon will display and the lower indicator beside the viewfinder will light yellow.
	4 Re-aim the camera to compose the shot as desired and shoot.

To Release the AF Lock

Press the  /  button.



- When shooting with the focus lock or AF lock using the LCD monitor, setting [AiAF] to [Off] (p. 85) is recommended since the camera focuses using the center AF frame only.
- The AF lock is convenient because you can let go of the shutter button to compose the image. Moreover, the AF lock is still effective after the picture is taken, allowing you to capture a second image with the same focus.
- The AF lock can be released by pressing the zoom lever or **MENU** button, by changing the shooting mode or by turning the LCD monitor off.

Locking the Exposure Setting (AE Lock)



Shooting Mode



You can set the exposure and focus separately. This is effective when the contrast is too strong between the subject and background or when a subject is backlit.



You must set the flash to . The AE lock cannot be set if the flash fires.



1 Press the **DISP.** button to turn the LCD monitor on.

2 Focus on the part of the subject on which you wish to lock the exposure setting.

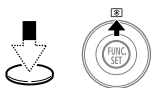

3 Press the shutter button halfway (two beeps will play) and press the button.

- The exposure setting is locked.
- The **AEL** icon will display.

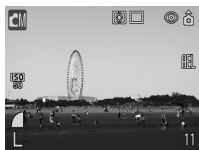

4 Re-aim the camera to compose the shot as desired and press the shutter button fully.

To Release the AE Lock

Press the button.



The AE lock may be released by pressing the zoom lever, **MENU** button or button, or by changing the white balance, ISO speed, photo effect or the shooting mode, or by turning the LCD monitor off.

Locking the Flash Exposure Setting (FE Lock)



Shooting Mode



You can lock the flash exposure so that the exposure settings are correctly set for a particular portion of your subject.

	1 Press the DISP. button to turn the LCD monitor on.
 	2 Press the ⚡ button to set the flash to ⚡ .
	3 Focus on the part of the subject on which you wish to lock the flash exposure setting.
 	4 Press the shutter button halfway (two beeps will play) and press the 👁 button. <ul style="list-style-type: none">• The flash will fire a pre-flash and lock the flash exposure to the required intensity to illuminate the subject.• The FEL icon will display.
	5 Re-aim the camera to compose the shot as desired and press the shutter button fully.

To Release the FE Lock

Press the **👁** button.



The FE lock may be released by pressing the zoom lever, **MENU** button or button, or by changing the white balance, ISO speed, photo effect or the shooting mode, or by turning the LCD monitor off.

Switching between Light Metering Modes

Shooting Mode



You can switch between metering modes to shoot.

	Evaluative	Appropriate for standard shooting conditions, including backlit scenes. The camera divides images into several zones for light metering. It evaluates complex lighting conditions, such as the position of the subject, the brightness, the direct light, and the backlighting, and adjusts the settings to the correct exposure for the main subject.
	Center Weighted Average	Averages the light metered from the entire frame, but gives greater weight to the subject matter at the center.
	Spot	Meters the area within the spot AE point at the center of the LCD monitor. Use this setting when you want to set the exposure on the subject in the center of the monitor.



1 Press the button to switch between metering modes.

The selected metering mode appears on the LCD monitor.

Adjusting the Exposure Compensation



Shooting Mode



Adjust the exposure compensation setting to avoid making the subject too dark when it is backlit or shot against a bright background or to avoid making lights appear too bright in night shots.

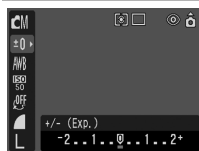

1 In the FUNC. menu, select **±0** *.

See *Selecting Menus and Settings* (p. 49).

* The current setting is displayed.



2 Use the **←** or **→** button to adjust the exposure compensation.

- The settings can be adjusted in 1/3 stops in the range -2 to +2.
- You can confirm the effect of the setting in the LCD monitor.
- You can shoot right after selecting an option. The menu displays again after the shot, allowing you to change the settings easily.



3 Press the FUNC./SET button.

The display will return to the shooting screen.

To Reset the Exposure Compensation

Return the setting to 0.



See *Photo Tips and Information* (p. 164).

Shooting in Long Shutter Mode



Shooting Mode



You can set the shutter speed to a slow setting to make dark subjects appear brighter.

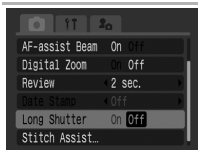

1 In the (Rec.) menu, select [Long Shutter].

See *Selecting Menus and Settings* (p. 49).



2 Use the or button to select [On] and press the MENU button.

The display will return to the shooting screen.

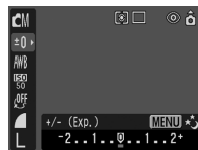

3 In the FUNC. menu, select * and press the MENU button.

See *Selecting Menus and Settings* (p. 49).

* The current setting is displayed.



4 Use the or button to select a shutter speed.

- The higher the value, the brighter the image and the lower the value, the darker the image.
- You can shoot right after selecting a value. The menu displays again after the shot, allowing you to change the settings easily.





5 Press the FUNC./SET button.

The display will return to the shooting screen.



To Cancel the Long Shutter mode

While [Long Shutter] is displayed in the FUNC. menu, press the **MENU** button.



The nature of CCD image sensors is such that noise in the recorded image increases at long shutter speeds. This camera, however, applies special processing to images shot at shutter speeds slower than 1.3 seconds to eliminate the noise, thereby producing high-quality images. Nevertheless, a certain amount of processing time may be required before the next image can be shot.



- Use the LCD monitor to confirm that the image was recorded at the desired brightness.
- Please note that camera shake becomes a factor at low shutter speeds. If the camera shake warning  appears on the LCD monitor, secure the camera to a tripod before shooting.
- Use of the flash may result in an over-exposed image. If that occurs, shoot with the flash set to .
- The following are unavailable:
 - Exposure Compensation
 - Light Metering
 - AE Lock
 - FE Lock
 - ISO speed: AUTO
 - Flash: Auto, Auto with Red-Eye Reduction, Flash on with Red-Eye Reduction

Available Shutter Speeds

The following shutter speeds (in seconds) are available.

15 13 10 8 6 5 4 3.2 2.5 2 1.6 1.3 1



3 Press the FUNC./SET button.

The display will return to the shooting screen.



This setting cannot be adjusted when the **S** (Sepia) or **BW** (B/W) photo effects are selected.

Setting a Custom White Balance

You can set a custom white balance to obtain the optimal setting for the shooting conditions by having the camera evaluate an object, such as a piece of white paper or cloth, or a photo-quality gray card that you wish to establish as the standard white color.

In particular, take a custom white balance reading for the following situations that are difficult for the **AWB** (Auto) setting to detect correctly.

- Shooting close-ups
- Shooting subjects of monotone color (such as sky, sea or forest)
- Shooting with a peculiar source of light (such as a mercury-vapor lamp)

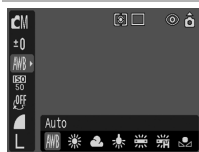

1 In the FUNC. menu, select **AWB** *.

See *Selecting Menus and Settings* (p. 49).

* The current setting is displayed.



2 Use the **←** or **→** button to select **AWB**.

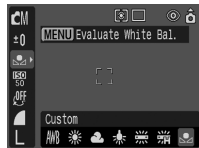



3 Aim the camera at the white paper, cloth or gray card and press the **MENU** button.

- If you are using the LCD monitor, compose the image so the paper or cloth completely fills the center frame in the display, or the entire viewfinder, before pressing the **MENU** button. The camera reads the white balance data when you press the **MENU** button.
- You can shoot right after selecting an option. The menu displays again after the shot, allowing you to change the settings easily.



4 Press the **FUNC./SET** button.

The display will return to the shooting screen.



- You are recommended to set the shooting mode to and the exposure compensation setting to zero (± 0) before setting a custom white balance. The correct white balance may not be obtained when the exposure setting is incorrect (image appears completely black or white).
- Shoot with the same settings as when reading the white balance data. If the settings differ, the optimal white balance may not be set. In particular, the following should not be changed.
 - ISO Speed
 - Flash
Setting the flash to on or off is recommended. If the flash fires when reading the white balance data with the flash set to (Auto) or (Auto with Red-Eye Reduction), make sure that you also use the flash when you shoot.
- Since the white balance data cannot be read in Stitch Assist mode, preset the white balance before selecting [Stitch Assist] in the (Rec.) menu.
- The camera will retain the custom white balance setting that you record even if you reset the camera to the default settings (p. 58).

Changing the Photo Effect



Shooting Mode



By setting a photo effect before you shoot, you can change the look and feel of the pictures you take.

	Effect Off	Records normally with this setting.
	Vivid	Emphasizes the contrast and color saturation to record bold colors.
	Neutral	Tones down the contrast and color saturation to record neutral hues.
	Low Sharpening	Records subjects with softened outlines.
	Sepia	Records in sepia tones.
	B/W	Records in black and white.

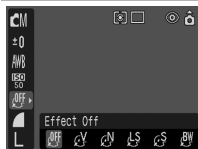

1 In the **FUNC.** menu, select *.

See *Selecting Menus and Settings* (p. 49).

* The current setting is displayed.



2 Use the **←** or **→** button to select an effect.

- You can confirm the photo effect in the LCD monitor.
- You can shoot right after selecting an option. The menu displays again after the shot, allowing you to change the settings easily.



3 Press the **FUNC./SET** button.

The display will return to the shooting screen.

Adjusting the ISO Speed



Shooting Mode



Raise the ISO speed when you wish to reduce the effects of camera shake, turn the flash off when shooting in a dark area, or use a fast shutter speed.



1 In the FUNC. menu, select *.

See *Selecting Menus and Settings* (p. 49).

* The current setting is displayed.



2 Use the or button to select a speed.

You can shoot right after selecting an option. The menu displays again after the shot, allowing you to change the settings easily.



3 Press the FUNC./SET button.

The display will return to the shooting screen.



- Higher ISO speeds increase image noise. To take clean images, use as low an ISO speed as possible.
- The AUTO setting selects the optimal speed. It will automatically raise the speed when the light from the flash is insufficient to illuminate the subject matter.



See *Photo Tips and Information* (p. 164).

Setting the Auto Rotate Function



Shooting Mode



Your camera is equipped with an Intelligent Orientation sensor that detects the orientation of an image shot with the camera held vertically and automatically rotates it to the correct viewing orientation in the display. You can set this function on/off.

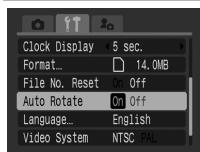

1 In the **[f]** (Set up) menu, select **[Auto Rotate]**.

See *Selecting Menus and Settings* (p. 49).



2 Use the **←** or **→** button to select **[On]** and press the **MENU** button.

- The display will return to the shooting screen.
- When the Auto Rotate function is set to **[On]** and the LCD monitor is set to the detailed display mode, the (normal), (right end is down) or (left end is down) will appear in the upper right of the display.



- This function may not operate correctly when the camera is pointed straight up or down. Check that the arrow is pointing in the right direction and if it is not, then set the Auto Rotate function to **[Off]**.
- Even if the Auto Rotate function is set to **[On]**, the orientation of images downloaded to a computer will depend upon the software used to download the images.



- When the camera is held vertically to shoot, the Intelligent Orientation sensor judges the upper end to be “up” and the lower end to be “down.” It then regulates the optimal white balance, exposure and focus for vertical photography. This function operates regardless of the On/Off status of the Auto Rotate function.

Resetting the File Number



The images you shoot are automatically assigned file numbers. You can select how the file number is assigned.

On	The file number is reset to the start (100-0001) each time a new SD card is inserted. New images recorded on SD cards with existing files are assigned the next available number.
Off	The file number of the last image to be shot is memorized so that images recorded to a new SD card start from the next number.

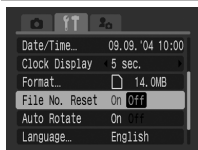

1 In the **[i]** (Set up) menu, select **[File No. Reset]**.

See *Selecting Menus and Settings* (p. 49).



2 Use the **←** or **→** button to select **[On]** or **[Off]** and press the **MENU** button.

The display will return to the shooting screen.



Setting the File No. Reset to [Off] is useful for avoiding file name duplication when images are downloaded to a computer.

About File Numbers and Folder Numbers

Images are assigned file numbers from 0001 to 9900, and folders are assigned folder numbers from 100 to 998 (Folder numbers cannot contain 99 in the last two digits).

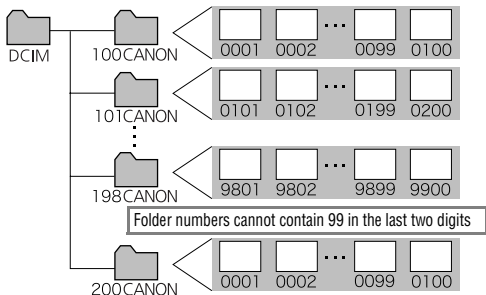

Folder File Capacity

Each folder usually contains up to 100 images.

However, since images shot in continuous shooting and Stitch Assist mode are always saved into the same folder, a folder may contain more than 100 images. The number of images may also exceed 100 if a folder contains images copied from a computer or images shot with other cameras. Please note, however, that the images in folders containing 2001 or more images cannot be played back in this camera.

Displaying Images Individually





1 Slide the mode switch to (Playback).

The last recorded image will appear in the display (single image playback).



2 Use the or button to move between the images.

Use the  button to move to the previous image and the  button to move the next image.

Holding the button down advances the images more rapidly, but the images will not appear as clearly.

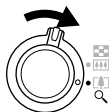

Approximate Location of the Magnified Area

1 Press the zoom lever toward Q.

SET will appear on the monitor. You can press the zoom lever toward Q to display the image at a magnification of up to 10x.



2 Use the ←, →, ↑ or ↓ button to move around the image.



3 Press the FUNC./SET button.

- The image advance mode will become active and **SET** will display in the LCD monitor. Press the ← or → button to display the preceding or next image at the same level of magnification.
- You can change the magnification level with the zoom lever.



4 Press the FUNC./SET button.

The image advance mode will cancel.

To Cancel the Magnified Display

Press the zoom lever toward . You can also cancel it immediately by pressing the **MENU** button.



Viewing Images in Sets of Nine (Index Playback)

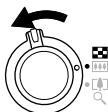

Selected Image



Movie

1 Press the zoom lever toward .

Up to nine images can be viewed at once in index playback.



2 Use the , , or button to change the image selection.

Switching between Sets of Nine Images



1 Press the zoom lever toward while in index playback.



2 Use the or button to move to the previous set or the next set of images.

Hold the **FUNC./SET** button down and press the or button to jump to the first or last set.

To Return to Single Image Playback

Press the zoom lever toward .

Viewing Movies



You can play movie clips shot in mode.



Movies cannot be played in the index playback mode.



1 Use the or button to select a movie.

Images with a **SET** icon are movies.



Movie Control Panel Volume Level

2 Press the **FUNC./SET** button.

- The movie control panel will display.
- Use the or button to adjust the sound volume.



3 Use the or button to select (Play) and press the **FUNC./SET** button.

- The movie and sound will play.
- When playback ends, the movie stops at the last frame displayed. Press the **FUNC./SET** button to display the movie control panel. Press the **FUNC./SET** button again to play from the beginning.

Pausing and Resuming Play



Press the **FUNC./SET** button during playback.

The movie playback pauses. Press the **FUNC./SET** button again to resume.

Operating the Movie Control Panel



1 Select a movie and press the **FUNC./SET** button (p. 106).

The movie control panel will display.



2 Use the **←** or **→** button to select one of the following and press the **FUNC./SET** button.



: Exit (Ends playback and returns to single image playback. Pressing the **MENU** button also returns to single image playback.)

: Play

: Slow Motion Playback

The playback speed will change if you press the **←** or **→** button in slow motion playback.

: First Frame

: Previous Frame (Rewinds if the **FUNC./SET** button is held down)

: Next Frame (Fast Forwards if the **FUNC./SET** button is held down)

: Last Frame

: Edit (Switches to movie editing mode) (p. 109)



-
- Movies recorded with high resolutions and frame rates may momentarily stop playing if played on slow reading SD cards.
 - Movies recorded at the  Fast Frame Rate setting and with the video signal set to the PAL format, may play back with a frame rate lower than the recorded one when output to a TV or video. You can play every frame by using the slow motion playback. To check the images at the original frame rate, you are recommended to play the movie back on the camera's LCD monitor or on a computer.
 - You may experience frame dropping and audio breakup when playing back a movie on a computer with insufficient system resources.
 - Movies shot with other cameras may not play back on this camera. See *List of Messages* (p. 148).



-
- You can adjust the playback volume of movie clips in the  (Set up) menu.
 - Use the television's controls to adjust the volume when playing a movie on a TV set (p. 140).
 - The audio cannot be played in slow motion playback.

Editing Movies



Selecting (Edit) in the movie control panel enables you to cut unwanted portions at the start or end of a movie clip.



Protected movies and movies less than 1 second in duration cannot be edited.



1 Use the or button to select a movie and press the **FUNC./SET** button.

Movie Editing Panel



Movie Editing Bar

2 Switch to the movie editing mode.

- See *Operating the Movie Control Panel* (p. 107).
- The movie editing panel and the movie editing bar will display.



3 Use the or button to select or and the or button to set the portion to which the cut is applied.

: Cut Beginning

: Cut End

: Cursor



4 Use the **↑** or **↓** button to select **▶ (Play)** and press the **FUNC./SET** button.

- A preview of the temporarily edited movie clip plays.
- To stop it, press the **FUNC./SET** button again.



5 Use the **↑** or **↓** button to select **□ (Save)** and press the **FUNC./SET** button.

Selecting **⏮ (Exit)** cancels the edits and returns to the movie control panel display.



6 Use the **←** or **→** button to select **[New File]** or **[Overwrite]** and press the **FUNC./SET** button.

- **[New File]** saves the edited movie under a new file name. The pre-edit data is left unchanged.

Note, if you press the **FUNC./SET** button while saving the movie, saving is canceled.

- **[Overwrite]** saves the edited movie with its original file name. The pre-edit data is lost.
- When the SD card lacks sufficient space to create a new file, only **[Overwrite]** can be selected.



- The minimum duration of a movie that can be edited is 1 second.
- It may take approximately 3 minutes to save an edited movie. If the battery pack runs out of charge partway through, edited movie clips cannot be saved. When editing movies, use a fully charged battery pack or the separately sold AC Adapter Kit ACK-DC10 (p. 154).

Rotating Images in the Display



Images can be rotated clockwise 90° or 270° in the display.

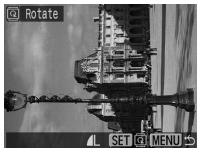

0° (Original)



90°

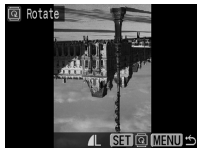

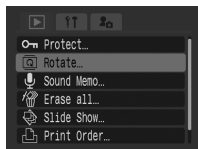

270°



1 In the  (Play) menu, select  and press the **FUNC./SET** button.

See *Selecting Menus and Settings* (p. 49).

2 Use the  or  button to select the image to be rotated and press the **FUNC./SET** button.

Cycle through the 90°/270°/0° orientations with each press of the **FUNC./SET** button.

3 Press the **MENU** button.

The display will return to the Play menu. Pressing the **MENU** button again returns to the playback screen.



- Movies cannot be rotated.
- When images are downloaded to a computer, the orientation of images rotated by the camera will depend upon the software used to download the images.



- Images can be magnified when rotated (p. 104).
- Images taken vertically with Auto Image Rotate (p. 99) set to [On] will automatically be rotated to the vertical position when viewed on the camera's LCD monitor.

Attaching Sound Memos to Images



In playback mode (including single image playback, index playback, and magnifying playback), you can attach sound memos (up to 60 seconds) to an image. The sound data is saved in the WAVE format.

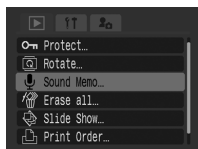

1 In the (Play) menu, select and press the **FUNC./SET** button.

See *Selecting Menus and Settings* (p. 49).



2 Use the or button to select an image and press the **FUNC./SET** button.

The sound memo control panel will display.



Sound Memo Panel



3 Use the or button to select (Record) and press the **FUNC./SET** button to record.

- The recording starts and the elapsed time is displayed.
- Press the **FUNC./SET** button again to stop recording. To resume recording, press the **FUNC./SET** button again.
- Up to 60 seconds of recordings may be added to any one image.
- To return to the previous screen, select (Exit) and press the **FUNC./SET** button.



Exiting Sound Memos

Press the **MENU** button.

Playing/Erasing Sound Memos



1 Display an image with a sound memo attached (p. 112) and press the **FUNC./SET** button.

- Images with sound memos attached have the   icons displayed on them.
- The sound memo control panel will display.



2 Use the **←** or **→** button to select **▶** (Play) or  (Erase) and press the **FUNC./SET** button.



Sound Memo Panel



▶ (Play)

- The sound memo will play. Playback will stop when you press the **FUNC./SET** button. Press the **FUNC./SET** button again to resume playback.
- Use the **▲** or **▼** button to adjust the sound volume.

 (Erase)

A confirmation menu will display. Use the **←** or **→** button to select [Erase] and press the **FUNC./SET** button.

To return the playback to the beginning, select  (Pause) while stopped and press the **FUNC./SET** button.



- You cannot attach sound memos to movies.
- The “Memory card full” message will display when the SD card is full and you will be unable to record sound memos to that card.
- If an incompatible sound memo is attached to an image, you will be unable to record or play sound memos for that image, and the “Incompatible WAVE format” message will display. You can erase incompatible sound data using the camera.
- Sound memos for protected images cannot be erased.



The volume can be adjusted in the  (Set up) menu (p. 55).

Automated Playback (Slide Shows)



Starting a Slide Show

A selection of images or all the images on an SD card can be displayed one-by-one in an automated slide show.

Slide show image settings are based on DPOF standards (p. 124).

All Images	Plays all images on the SD card in order.
Slide Show 1-3	Plays the images selected for each slide show in order (p. 115).



1 In the (Play) menu, select and press the FUNC./SET button.

- See *Selecting Menus and Settings* (p. 49).
- The Slide Show menu will display.



2 Use the or button to select [Program] and the or button to select [All Images], [Show 1], [Show 2] or [Show 3].

See p.116 from step 3, for selecting the playback images in slide shows 1-3.

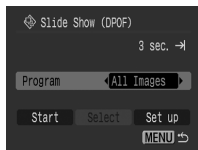

3 Use the or button to select [Start] and press the FUNC./SET button.

The slide show starts. The Slide Show menu will reappear after the playback ends.





4 Press the MENU button.

The display will return to the Play menu. Pressing the **MENU** button again returns to the playback screen.



- Movies play for their entire recorded length regardless of the time set in the slide show settings.
- The power-saving function does not activate during a slide show (p. 55).

Pausing/Resuming a Slide Show



Press the FUNC./SET button.

The slide show pauses. Press the **FUNC./SET** button again to restart it.

Fast Forwarding/Rewinding a Slide Show



Press the ← or → button.

The previous or next image displays. Hold down the button to advance through the images more rapidly.

Stopping a Slide Show



Press the MENU button.

The slide show stops and the Slide Show menu reappears.

Selecting Images for Slide Shows

You can mark images for inclusion in slide shows 1-3. Up to 998 images may be marked per slide show. Images display in the order of their selection.

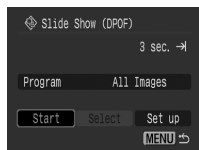

1 Display the Slide Show menu.

See *Starting a Slide Show* (p. 114).



- 2** Use the **↑** or **↓** button to select [Program] and the **←** or **→** button to select [Show 1], [Show 2] or [Show 3].

A white checkmark will appear beside a show already containing images.



- 3** Use the **↑** or **↓** button and the **←** or **→** button to choose [Select] and press the **FUNC./SET** button.



- 4** **Select images for the Slide Show**

- Use the **←** or **→** button to move between images and the **↑** or **↓** button to select or deselect them. Selected images display a number corresponding to their selection order and a white checkmark .
- You can press the zoom lever toward  to switch to the index mode (3 images) and use the same procedures to select images.
- While in index playback, pressing the **FUNC./SET** button displays the menu for selecting or deselecting all images. Use the **↑** or **↓** button to select [Mark all] or [Clear all] and press the **FUNC./SET** button.



- 5** **Press the MENU button.**

Press the **MENU** button repeatedly until the Playback screen reappears to finish the procedure.

Adjusting the Play Time and Repeat Settings

You can change the play time for all the images in a show and have the show repeat continuously.

Play Time	Sets the duration that each image displays. Choose between 3-10 seconds, 15 seconds, 30 seconds and Manual.
Repeat	Sets whether the slide show stops when all the slides have been displayed or continues until stopped.

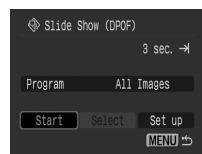

1 Display the Slide Show menu.

See *Starting a Slide Show* (p. 114).



2 Use the ← or → button to select [Set up] and press the FUNC./SET button.



3 Use the ↑ or ↓ button to select [Play Time] or [Repeat] and the ← or → button to select an option.



4 Press the MENU button.

The set up menu will close. Pressing the **MENU** button again returns to the Play menu. Press it again to go back to the playback screen.



- The display interval may vary slightly from the set time for some images when played.
- Slide shows are easy to arrange on a computer with the supplied software (ZoomBrowser EX/ImageBrowser). See the *Canon Digital Camera Software Starter Guide Disk*.

Protecting Images



You can protect important images and movies from accidental erasure.

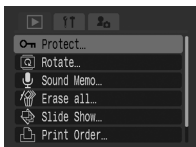

1 In the (Play) menu, select and press the **FUNC./SET** button.

See *Selecting Menus and Settings* (p. 49).



2 Use the **←** or **→** button to select an image to protect and press the **FUNC./SET** button.

- The icon appears on protected images.
- You can make the selection of images easier by toggling between single image playback and index playback by pressing the zoom lever toward or .



Protection Icon



3 Press the **MENU** button.

The Play menu displays again. Press it again to return to the playback screen.

To Cancel Protection

After step 1, select an image to remove protection from and press the **FUNC./SET** button.



Please note that formatting (initializing) an SD card erases all data, including protected images (p. 28).

Erasing Single Images



- Please note that erased images cannot be recovered. Exercise adequate caution before erasing a file.
- Protected images cannot be erased with this function.



1 Use the **←** or **→** button to select an image for deletion and press the  button.



2 Use the **←** or **→** button to select [Erase] and press the FUNC./SET button.

To exit instead of erasing, select [Cancel].



Erasing All Images



You can erase all the images saved on the SD card.



- Please note that erased images cannot be recovered. Exercise adequate caution before erasing a file.
- Protected images cannot be erased with this function.

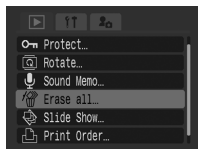

1 In the (Play) menu, select and press the FUNC./SET button.

See *Selecting Menus and Settings* (p. 49).



2 Use the or button to select [OK] and press the FUNC./SET button.

To exit instead of erasing, select [Cancel].

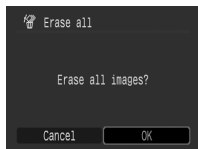

You should format the SD card when you want to erase not only image data but also all the data contained on the card (p. 28).

About Printing



Images shot with this camera can be printed using one of the following methods.

- Connecting the camera to a direct print compatible printer^{*1} with a single cable and pressing the  button on the camera.
- Selecting images and specifying the number of print copies (DPOF^{*2} print settings) with the camera before sending the images (SD card) to a photo developing center

^{*1} Since this camera uses a standard protocol (PictBridge), you can use it with other PictBridge-compliant printers in addition to Canon-brand compact photo printers (SELPHY CP series), card photo printers and Bubble Jet Printers (PIXMA series/SELPHY DS series).

^{*2} Digital Print Order Format

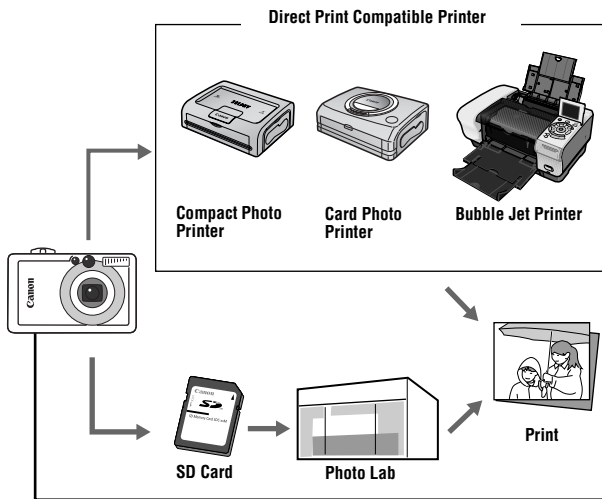

This guide explains DPOF print settings. For information on how to print images, refer to the *Direct Print User Guide* supplied with the camera. Also, refer to your printer's manual.

Please check the *System Map* to confirm the compact photo printer (SELPHY CP series), card photo printer models and Bubble Jet Printers (PIXMA series/SELPHY DS series) that can be used with this camera.

Direct Print Compatible Printing

- Connect the camera to the printer
- Set various print settings (except DPOF print settings)
- Print

For details, see the *Direct Print User Guide*.

DPOF Print Settings

- See *Selecting Images for Printing* (p. 124).
▼
- Set the number of print copies (pp. 125, 127)
▼
- See *Setting the Print Style* (p. 128).
 - Standard/Index/Both
 - Date: On/Off
 - File Numbers: On/Off

For details, see the *Direct Print User Guide*.

DPOF Transfer Order

- Select the images to download to a computer (p. 130)

Setting the DPOF Print Settings



You can select images on an SD card for printing and specify the number of print copies in advance using the camera. This is extremely convenient for sending the images to a photo developing service that supports DPOF, or for printing on a direct print compatible printer.

See the *Direct Print User Guide* for instructions on how to print.

Selecting Images for Printing

There are two ways to select images.

- Singly
- All images on an SD card (the number of print copies is set to one per image)

Single Images

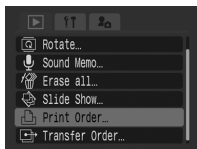

1 In the (Play) menu, select and press the **FUNC./SET** button.

See *Selecting Menus and Settings* (p. 49).



2 Use the **←** or **→** button to select **[Order]** and press the **FUNC./SET** button.

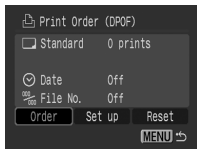

To cancel the Print Order settings, select **[Reset]**.



Number of Print Copies





Selected for an Index Print







3 Select images for printing.





As shown below, selection methods differ according to the options chosen for the  (Print Type) settings (p. 128).

(Print Type)

-  (Standard)/ (Both)

Use the  or  button to select an image and the  or  button to select the number of print copies (up to maximum of 99).

-  (Index)

Use the  or  button to move to an image and the  or  button to select or deselect it.

A checkmark displays on selected images.

You can press the zoom lever toward  to switch to the index mode (3 images) and use the same procedures to select images.



4 Press the MENU button.

The Print Order menu will reappear. Pressing the **MENU** button again returns to the Play menu. Press it again to go back to the playback screen.

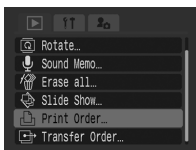

All the Images on an SD Card



- 1** In the  (Play) menu, select  and press the FUNC./SET button.

See *Selecting Menus and Settings* (p. 49).



- 2** Use the  or  button to select [Order] and press the FUNC./SET button.

To cancel the DPOF print settings, select [Reset].

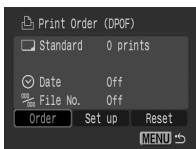

- 3** Press the zoom lever toward .

The display switches to index playback (3 images).



- 4** Press the FUNC./SET button.



5 Use the **▲** or **▼** button to select [Mark all] and press the **FUNC./SET** button.

- One copy is set to print for each image.
- When the print type is set to (Standard) or (Both), the number of print copies can be set individually for each image. When (Index) is selected, the print settings can be deleted.
- You can cancel all the settings by selecting [Clear all].



6 Press the **MENU** button.

The Print Order menu will reappear. Pressing the **MENU** button again returns to the Play menu. Press it again to go back to the playback screen.









- The symbol will display on images that have had print settings set by other DPOF-compliant cameras. These settings will be overwritten by those set by your camera.
- The output of some printers or photo developing services may not reflect the specified print settings.
- Print settings cannot be set for movie images.



- Images are printed in order from oldest to newest by the shooting date.
- A maximum of 998 images can be selected per SD card.
- When [Both] is selected, the number of print copies can be set, but it applies to Standard prints only. The Index setting only produces one print copy.
- Print settings can also be assigned to images with the bundled software (ZoomBrowser EX/Image Browser) on a computer. However, do not set the date in the DPOF print settings when printing images that have had the date embedded with the [Date Stamp] function. This may cause the date to be printed twice.

Setting the Print Style

Set the print style after selecting the image to print. The following print settings can be selected.

 Print Type	 Standard	Prints one image per page.
	 Index	Prints the selected images together at a reduced size in an index format.
	 Both	Prints the images in both the standard and index formats.
 Date		Adds the date to the print.
 File No.		Adds the file number to the print.

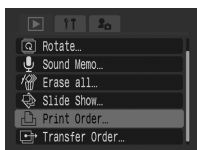

1 In the  (Play) menu, select  and press the **FUNC./SET** button.

See *Selecting Menus and Settings* (p. 49).



2 Use the **←** or **→** button to select **[Set up]** and press the **FUNC./SET** button.

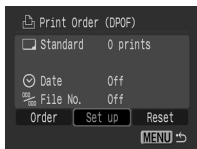

All print settings for the image are canceled when you select **[Reset]**.

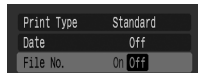
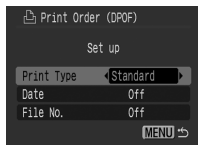

3 Use the **↑** or **↓** button to select [Print Type], [Date] or [File No.] and the **←** or **→** button to select an option.

 **(Print Type)**

Select [Standard], [Index] or [Both].

(Date)

Select [On] or [Off].

 **(File No.)**

Select [On] or [Off].



4 Press the **MENU** button.

The Print Order menu will reappear. Pressing the **MENU** button again returns to the Play menu. Press it again to go back to the playback screen.



- When the print type is set to [Index], the [Date] and [File No.] options cannot be set to [On] at the same time.
- If you selected [Standard] or [Both] as the Print Type, you can also set the Date and File No. settings to [On] at the same time. However, the data that is supported may vary among printers.
- Embedded dates in  (Postcard Date Imprint mode, p. 74) print out even when [Date] is set to [Off].



The date prints in the format specified in the Date/Time menu (p. 31).

Image Transmission Settings (DPOF Transfer Order)

You can use the camera to specify settings for images before downloading to a computer. Refer to the *Canon Digital Camera Software Starter Guide Disk* for instructions on how to transfer images to your computer.

The settings used on the camera comply with the Digital Print Order Format (DPOF) standards.



The  icon may display for an SD card that has had transfer settings set by a different DPOF-compliant camera. These settings will be overwritten by those set by your camera.

Selecting Images for Transferring

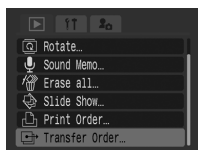

1 In the  (Play) menu, select  and press the **FUNC./SET** button.

See *Selecting Menus and Settings* (p. 49).



2 Use the **←** or **→** button to select **[Order]** and press the **FUNC./SET** button.



All transfer settings for the image are canceled when you select **[Reset]**.





Selected for Transfer



3 Use the ← or → button to move between images and the ↑ or ↓ button to select and deselect them.

- A checkmark displays on selected images.
- You can press the zoom lever toward  to switch to the index mode (3 images) and use the same procedures to select images.
- While in index playback, pressing the **FUNC./SET** button displays the menu for selecting or deselecting all images. Use the ↑ or ↓ button to select [Mark all] or [Clear all] and press the **FUNC./SET** button.



4 Press the MENU button.

The Transfer Order menu reappears. Pressing the **MENU** button again returns to the Play menu. Press it again to go back to the playback screen.



- Images are transferred in order from oldest to newest by the shooting date.
- A maximum of 998 images can be selected per SD card.

Connecting the Camera to a Computer

The following methods can be used to download images recorded by the camera to a computer. Please read *Computer System Requirements* (p. 133) in advance.

• Downloading via a Camera to Computer Connection

Windows 98	Windows Me	Windows 2000	Windows XP	Mac OS X
---------------	---------------	-----------------	---------------	-------------

With this method, you download images using computer commands after you have installed the appropriate software.

See *Connecting the Camera to a Computer* (p. 133), and the separate *Canon Digital Camera Software Starter Guide Disk*.

Windows 98	Windows Me	Windows 2000	Windows XP
---------------	---------------	-----------------	---------------

With this method, you download images using camera button operations after you have installed the appropriate software (the computer settings only need to be adjusted for the first download).

See *Connecting the Camera to a Computer* (p. 133) and *Downloading Images by Direct Transfer* (p. 137).

Windows XP	Mac OS X
---------------	-------------

With this method, you download images using computer commands without installing any software.

See *Connecting the Camera to a Computer* (p. 133) (Software Installation Not Required) and *Connecting the Camera to the Computer to Download Images without Installing Software* (p. 139).

• Downloading Directly from an SD Card

See *Downloading Directly from an SD Card* (p. 139).

Connecting the Camera to a Computer

Computer System Requirements

Please install and use the software on a computer which meets the requirements below.

Windows

OS	Windows 98 (Second Edition (SE) Only) Windows Me Windows 2000 (Service Pack 4 Only) Windows XP (Including Service Pack 1)
Computer Model	The above OS should be pre-installed on computers with built-in USB ports.
CPU	Pentium 500 MHz or higher processor is required
RAM	Windows 98 SE/Windows Me: 128 MB or more Windows 2000/Windows XP: 256 MB or more
Interface	USB
Free Hard Disk Space	<ul style="list-style-type: none">• Canon Utilities<ul style="list-style-type: none">- ZoomBrowser EX: 250 MB or more (Including the PhotoRecord printing program)- PhotoStitch: 40 MB or more• Canon Camera TWAIN Driver: 25 MB or more• Canon Camera WIA Driver: 25 MB or more
Display	1,024 x 768 pixels / High Color (16 bit) or better is required

Macintosh

OS	Mac OS X (v10.1.5 – v10.3)
Computer Model	The above OS should be pre-installed on computers with built-in USB ports.
CPU	PowerPC G3/G4/G5
RAM	256 MB or more
Interface	USB
Free Hard Disk Space	<ul style="list-style-type: none">• Canon Utilities<ul style="list-style-type: none">- ImageBrowser: 200 MB or more- PhotoStitch: 40 MB or more
Display	1,024 x 768 pixels / 32,000 colors or better is required

IMPORTANT

You must install the software and driver bundled on the supplied Canon Digital Camera Solution Disk onto your computer before connecting the camera to a computer.



The camera will not operate correctly if you connect it to your computer before installing the driver and software. If this happens, please refer to the Troubleshooting section of the *Canon Digital Camera Software Starter Guide Disk*.



- You do not need to turn off the camera or computer power when making a USB connection.
- Please refer to your computer's manual for information regarding the location of the USB port.
- You are recommended to use a fully charged battery pack or the AC Adapter Kit ACK-DC10 (sold separately) to power the camera when connecting to a computer (p. 21).
- All procedures performed with a connection to a USB 2.0 compliant board are not guaranteed.

1 Install the driver and the software applications bundled on the Canon Digital Camera Solution Disk (first time only).

- Please see the *Canon Digital Camera Software Starter Guide Disk* for the installation procedures.
- With a Macintosh, it is next necessary to set the ImageBrowser auto start settings. Please see the *Canon Digital Camera Software Starter Guide Disk* for details.

2 Use the supplied interface cable to connect the computer's USB port to the camera's DIGITAL terminal.

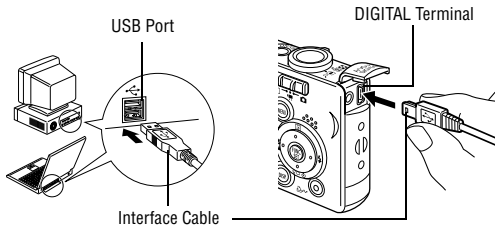

- Please see *How to Open the Terminal Cover* (pp. 13, 16).
- Insert the interface cable until it clicks into place.
- Treat the connector area with great care while you attach and remove the interface cable.
- Always grasp the connector's sides to remove the interface cable from the camera's DIGITAL terminal.

3 Set the mode switch to  (Playback).

4 Press the ON/OFF button until the power lamp lights green.

• **Windows:**

Proceed to step 5 below.

• **Macintosh:**

Refer to the *Canon Digital Camera Software Starter Guide Disk* and download images.

5 Select [Canon CameraWindow] in the event dialog that appears on the computer and click [OK] (first time only).

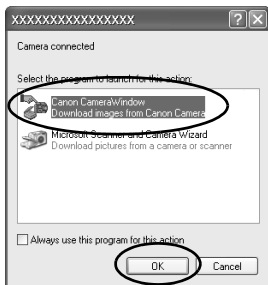

If the event dialog fails to appear, click the [Start] menu, and select [Programs] or [All Programs], followed by [Canon Utilities], [CameraWindow], and [CameraWindow].





The following window will display.



- **Using the software and computer to download images:**
See the *Canon Digital Camera Software Starter Guide Disk*.
- **Using the Camera to Download Images (Direct Transfer Function)**
See *Downloading Images by Direct Transfer* (p. 137).

Downloading Images by Direct Transfer

Use this method to download images using camera operations. Install the supplied software and adjust the computer settings before using this method for the first time (p. 134).

	All Images	Transfers and saves all images to the computer.
	New Images	Transfers and saves to the computer only the images that have not been previously transferred.
	DPOF Trans. Images	Transfers and saves to the computer only the images with DPOF Transfer Order settings (p. 130).
	Select & Transfer	Transfers and saves single images to the computer as you view and select them.
	Wallpaper	Transfers and saves single images to the computer as you view and select them. The transferred images display on the computer desktop.

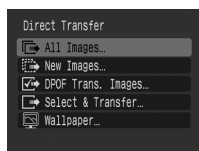

1 Confirm that the Direct Transfer menu is displayed on the camera's LCD monitor.

- The  button will light blue.
- Press the **MENU** button if the Direct Transfer menu fails to appear.

All Images/New Images/DPOF Trans. Images



2 Use the or button to select , or , and press the button.

- To cancel the transfer, press the **FUNC./SET** button.
- The images will download. The  button will blink blue while downloading is in progress. The display will return to the Direct Transfer menu when the download is complete.

Select & Transfer/Wallpaper



- 2** Use the **↑** or **↓** button to select **↓** or **↓**, and press the **↓** button (or FUNC./SET button).



- 3** Use the **←** or **→** button to select images to download and press the **↓** button (or FUNC./SET button).

The images will download. The **↓** button will blink blue while downloading is in progress.



- 4** Press the **MENU** button.

The Direct Transfer menu will reappear.



Only JPEG format images can be downloaded as wallpaper for the computer. They are automatically converted to the BMP format after downloading.



The option selected with the **↓** button is retained even when the camera's power is turned off. The previous setting will be in effect the next time the Direct Transfer menu is displayed. The image selection screen will appear directly when the [Select & Transfer] or the [Wallpaper] option was last selected.

Connecting the Camera to the Computer to Download Images without Installing Software

If you are using Windows XP or Mac OS X (v10.1.5 – v10.3), you can use the software distributed with these operating systems to download images without installing the software bundled on the Canon Digital Camera Solution Disk. This is useful for downloading images to a computer in which the software is not installed.

However, please note that there are certain limitations to downloading with this method. For more details, please refer to the supplied leaflet entitled *For Windows® XP and Mac OS X Users*.

1 Use the supplied interface cable to connect the computer's USB port to the camera's DIGITAL terminal.

See steps 2-4 and onward starting on p.134.

2 Follow the onscreen instructions to proceed with downloading.

Downloading Directly from an SD Card

1 Eject the SD card from the camera and insert it into an SD card reader connected to the computer.

Refer to your card adapter's or card reader's manual for information regarding the connection between the computer and card adapter or card reader.

2 Double-click the icon of the drive containing the SD card.

Depending on the operating system, the drive containing the SD card may display automatically.

3 Copy the SD card's images to the desired folder on the hard disk.

The images are contained in the [xxxCANON] folder, which is a subfolder of the [DCIM] folder on the SD card. The xxx represents a number from 100 to 998 (p. 101).

Viewing Images on a TV set

You can use a video-compatible television as a monitor to shoot or play back images when it is connected to the camera with the supplied AV Cable AVC-DC300.



1 Turn off the Camera and the TV. (p. 36)

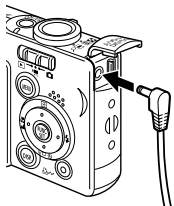

2 Connect the AV cable to the camera's A/V OUT terminal.

- Use the toggle on the wrist strap to open the terminal cover (pp. 13, 16) and insert the AV cable all the way.
- Treat the connector area with great care while you attach and remove the AV cable.

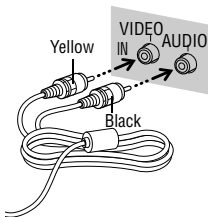

3 Plug the other ends of the AV cable to the VIDEO IN and AUDIO IN jacks on the TV.

4 Turn on the TV and switch it to Video mode.

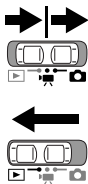

- 5** Slide the mode switch to (Shooting), (Movie) or (Playback).

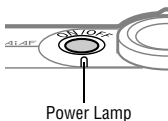

- 6** Press the ON/OFF button until the power lamp lights green.

- The image will appear on the TV. Shoot or play back images as usual.
- Press the **DISP.** button when images are not being displayed on the TV when shooting.



- A TV set cannot be used in Stitch Assist mode.
- No image will appear on the LCD monitor when the camera is connected to a TV.
- If the TV is a stereo model, you can plug the audio plug into either the left or right Audio In jack. Please refer to the TV's manual for details.



The video output signal can be switched (NTSC or PAL) to accommodate different regional standards (p. 56). The default setting varies between regions.

- NTSC: Japan, U.S.A., Canada, Taiwan and others
- PAL: Europe, Asia (excluding Taiwan), Oceania and others

If the video system is set incorrectly, the camera output may not display properly.

Customizing the Camera (My Camera Settings)

My Camera allows you to customize the start-up image and start-up, operation, self-timer and shutter sounds. Each menu item has three choices.

Example: Start-up Image



1



2

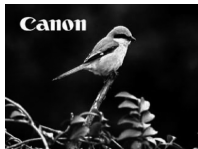

3

The **2** option features science fiction related images and sounds. The **3** option features animals.

Changing My Camera Settings



1 Select the **My Camera** menu.

See *Selecting Menus and Settings* (p. 49).



2 Use the **↑** or **↓** button to select an item.



3 Use the **←** or **→** button to select an option.

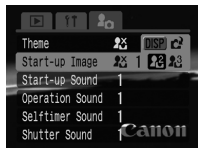



4 Press the MENU button.

- The menu will close.
- In Shooting mode, the menu can be closed by pressing the shutter button halfway.



- If you select  (Theme) in Step 2, you can select a consistent theme for each of the My Camera settings.
- The beep will not play but the start-up image will display if the [Mute] option in the  (Set up) menu is set to [On] even if a setting has been selected in the My Camera menu.

Registering My Camera Settings

Images recorded onto the SD card and newly recorded sounds can be added as My Camera settings to the **[2]** and **[3]** menu items. You can also use the supplied software to upload your computer's images and sounds to the camera.

The following menu items can be saved to the camera.

- Start-up Image • Shutter Sound • Selftimer Sound
- Operation Sound • Start-up Sound



A computer is required to restore the My Camera Settings to the defaults. Use the supplied software (ZoomBrowser EX/ImageBrowser) to add the default settings to the camera.

Registering SD Card Images and Sounds



- 1 Slide the mode switch to (Playback).



- 2 Select the (My Camera) menu.
See *Selecting Menus and Settings* (p. 49).



- 3 Use the or button to select an item.



- 4 Use the or button to select **[2]** or **[3]**.

The **[DISP]** icon will display.

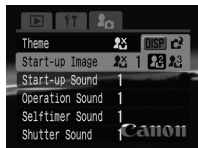



5 Press the DISP. button.



6 Select an image or record a sound.

Start-up Image

Use the **←** or **→** button to select the image you wish to register and press the **FUNC./SET** button.

Start-up, Operation, Self-timer and Shutter Sounds

- Use the **←** or **→** button to select (Record) and press the **FUNC./SET** button. Recording will start and automatically stop when the time is exceeded.
- After recording, use the **←** or **→** button to select (Register Sound) and press the **FUNC./SET** button.
- Select (End) to return to the My Camera menu without registering.
- Select (Play) to play the recorded sound.



7 Use the **←** or **→** button to select [OK] and press the FUNC./SET button.

To cancel the change, select [Cancel].



- The following cannot be registered as My Camera Settings.
 - Movies
 - Sounds recorded with the sound memo function (p. 112)
- The prior setting is erased when a new My Camera setting is added.

File Format of My Camera Settings





My Camera settings should conform to the file formats below. However, SD card images shot with this camera can be registered as My Camera settings regardless of the below formats. (Excluding sounds recorded as a movie or with the sound memo function (p. 112).)

Start-up Image

- Recording Format: JPEG (Baseline JPEG)
- Sampling Rate: 4:2:0 or 4:2:2
- Dimensions: 320 x 240 pixels
- File Size: 20 KB or less

Start-up, Operation, Self-timer and Shutter Sounds

- Recording format: WAVE (monaural)
- Quantization Bits: 8 bit
- Sampling Frequency: 11.025 kHz or 8.000 kHz
- Recorded Length

	11.025 kHz	8.000 kHz
 Start-up Sound	1.0 sec. or less	1.3 sec. or less
 Operation Sound	0.3 sec. or less	0.4 sec. or less
 Selftimer Sound	2.0 sec. or less	2.0 sec. or less
 Shutter Sound	0.3 sec. or less	0.4 sec. or less

* Any file formats other than those described above cannot be used with this camera.

An example of this function is to record “Say Cheese” as a self-timer sound so that the camera will replay this sound 2 seconds before the photo is taken. You could also record cheerful music to bring out the natural smiles of your subjects, or so they can strike a pose fitting the music. In these ways you can customize your camera by creating and adding new My Camera settings.







See the supplied *Canon Digital Camera Software Starter Guide Disk* for more information on creating and adding to the My Camera files.

List of Messages

The following messages may appear on the LCD monitor during shooting or playback. Please refer to the *Direct Print User Guide* for the messages that display during a printer connection.

Busy...	Image is being recorded to, or read from, SD card.
No memory card	You attempted to shoot or play back images without an SD card installed.
Card locked!	The SD card is write-protected.
Cannot record	You attempted to shoot an image without an SD card installed, or attempted to attach a sound memo to a movie.
Memory card error!	SD card has experienced an anomaly.
Memory card full	SD card is full of images and no more can be recorded or saved. Or no more image settings (slide show and printing settings, etc.) or sound memos can be recorded.
Naming error!	The file could not be created because there is a file with the same name as the directory that the camera is attempting to create, or the highest possible file number has already been reached. In the  Rec. Menu, set the File Reset option to [On]. Save all the images you wish to retain onto a computer, then reformat the SD card. Please note that formatting will erase all the existing images and other data.
Change the battery pack.	Battery charge is insufficient to operate the camera. Replace it at once with a charged one or recharge the battery pack.
No image.	No images recorded on SD card.
Image too large.	You attempted to play back an image larger than 4064 x 3048 pixels or with a large file size.
Incompatible JPEG format.	You attempted to play back an incompatible JPEG file.
Corrupted Data.	You attempted to play back an image with corrupted data.

RAW	You attempted to play back an image recorded in the RAW format.
Unidentified Image	You attempted to play back an image that was recorded in a special format (proprietary format used by the camera of another manufacturer, etc.) or a movie clip recorded by another camera.
Cannot magnify!	You attempted to magnify an image recorded in a different camera or format, an image edited with a computer, or a movie.
Cannot rotate	You attempted to rotate an image recorded in a different camera or format, an image edited with a computer, or a movie.
Incompatible WAVE format.	A sound memo cannot be added to this image since the format of the existing sound memo is incorrect.
Cannot register this image!	You attempted to add a start-up image or a movie that was created with another camera.
Protected!	You attempted to erase a protected image or movie.
Too many marks.	Too many images have been marked with print settings or transfer settings. Cannot process any more.
Cannot complete!	Could not save the print or transfer settings.
Unselectable image.	You attempted to set the print settings for a non-JPEG file.
Exx	(xx: number) Camera malfunction. Turn the power off and then back on, then shoot or play back. A problem exists if the error code reappears. Note the number and contact your Canon Customer Support Help Desk. If an error code displays directly after taking a picture, the shot may not have been recorded. Check image in playback mode.

Problem	Cause	Solution
Camera will not operate	Power is not turned on	<ul style="list-style-type: none"> • Press the ON/OFF button for a moment.
	SD card slot/battery cover is open	<ul style="list-style-type: none"> • Confirm that the SD card slot/battery cover is securely closed.
	Insufficient battery voltage	<ul style="list-style-type: none"> • Insert a fully charged battery into the camera. • Use the AC Adapter Kit ACK-DC10 (sold separately).
	Poor contact between camera and battery terminals	<ul style="list-style-type: none"> • Polish the terminals with a soft cotton swab before charging or using the battery pack.
Camera will not record	Mode switch is set to  (Playback)	<ul style="list-style-type: none"> • Set the mode switch to  or .
	Flash is charging (Blinking  in the LCD monitor)	<ul style="list-style-type: none"> • The indicator will light orange when it is charged. You can then press the shutter button.
	SD card is full	<ul style="list-style-type: none"> • Insert a new SD card. • If required, download the images to a computer and erase them from the SD card to make space.
	SD card is not formatted correctly	<ul style="list-style-type: none"> • Format SD card. ➔ See <i>Formatting SD Cards</i> (p. 28). • If reformatting does not work, the SD card logic circuits may be damaged. Consult the nearest Canon Customer Support Help Desk.
	SD card is write-protected.	<ul style="list-style-type: none"> • Slide the write protect tab of the SD card upward (p. 26).
Cannot play back	You attempted to play back images shot with another camera or images edited with a computer	<ul style="list-style-type: none"> • Computer images that cannot be played back will play back if they are added to the camera using the bundled software program ZoomBrowser EX or ImageBrowser.

Problem	Cause	Solution
Cannot play back	File name was changed with a computer or file location was changed	<ul style="list-style-type: none"> • Set the file name or location on the file format/structure of the camera. ➡ See <i>About File Numbers and Folder Numbers</i> (p. 101).
Lens will not retract	SD card slot/battery cover was opened with power on	<ul style="list-style-type: none"> • First close the SD card slot/battery cover and then turn the power off.
	SD card slot/battery cover was opened while recording to the SD card (warning signal sounds)	<ul style="list-style-type: none"> • First close the SD card slot/battery cover and then turn the power off.
Battery pack consumed quickly	Battery life exceeded if battery pack loses its charge quickly at normal temperature (23 °C/73 °F)	<ul style="list-style-type: none"> • Replace the battery pack with a new one.
Battery pack will not charge	Battery pack life exceeded	<ul style="list-style-type: none"> • Replace the battery pack with a new one.
	Poor contact between battery pack and battery charger	<ul style="list-style-type: none"> • Insert battery pack securely into battery charger. • Ensure that battery charger plug is securely plugged into the power outlet.
Sounds come from the camera interior	The camera's horizontal/vertical orientation was changed	<ul style="list-style-type: none"> • The camera's orientation mechanism is operating. There is no malfunction.
Image is blurred or out of focus	Camera moved	<ul style="list-style-type: none"> • Be careful not to move the camera while pressing the shutter button.
	Autofocus function hampered by obstruction to AF-assist Beam	<ul style="list-style-type: none"> • Be careful not to block the AF-assist Beam with fingers or other items.
	AF-assist Beam is set to [Off]	<ul style="list-style-type: none"> • Set the AF-assist Beam to [On] (p. 53).

Problem	Cause	Solution
Image is blurred or out of focus	Subject is out of focal range	<ul style="list-style-type: none"> • For normal shooting conditions, stay at least 30 cm (1.0 ft.) from the subject. • In macro mode, stay in the range of 30 - 50 cm (1.0 - 1.6 ft.) from the subject (3 - 50 cm (1.2 in. - 1.6 ft.) at maximum wide angle). • In digital macro mode, stay in the range of 3-10 cm (1.2 - 3.9 in.) from the subject at maximum wide angle. • Use the Infinity mode to shoot distant subjects.
	The subject is hard to focus on	<ul style="list-style-type: none"> • Use the focus lock or AF lock to shoot. ➔ See <i>Shooting Hard-to-Focus Subjects (Focus Lock, AF Lock)</i> (p. 86).
Subject in recorded image is too dark	Insufficient light for shooting	<ul style="list-style-type: none"> • Set the flash to on.
	Subject is dark in contrast to the background	<ul style="list-style-type: none"> • Set the exposure compensation to a positive (+) setting, use AE lock or use the spot metering function.
	Subject is too far away for flash to reach	<ul style="list-style-type: none"> • Shoot within 3.5 m (11.5 ft.) of the subject at the maximum wide angle or 2.0 m (6.6 ft.) of the subject at the telephoto end setting using the flash. • Raise the ISO sensitivity and then shoot. See <i>Adjusting the ISO Speed</i> (p. 98).
Subject in recorded image is too bright	Subject is too close, making the flash too strong	<ul style="list-style-type: none"> • When using the flash, stay at least 50 cm (1.6 ft.) from the subject.
	Subject is bright in contrast to the background	<ul style="list-style-type: none"> • Set the exposure compensation to a negative (-) setting, use AE lock or use the spot metering function.

Problem	Cause	Solution
Subject in recorded image is too bright	Light is shining directly on the subject or reflected off the subject into the camera	<ul style="list-style-type: none"> • Change the shooting angle.
	Flash is set to on	<ul style="list-style-type: none"> • Set the flash to off.
A bar of light (red, purple) appears on the LCD monitor	Subject is too bright	<ul style="list-style-type: none"> • This is a normal occurrence in devices containing CCDs and does not constitute a malfunction. (This bar of light will not be recorded when shooting still photos, but it will be recorded when shooting movies.)
White dots appear on the image	Light from the flash has reflected off dust particles or insects in the air. (This is especially noticeable when shooting at wide angle)	<ul style="list-style-type: none"> • This is a phenomenon that occurs with digital cameras and does not constitute a malfunction.
Flash does not fire	Flash is set to off	<ul style="list-style-type: none"> • Set the flash to on.
Image not showing on TV monitor	Incorrect video system setting	<ul style="list-style-type: none"> • Set the video system to the appropriate setting, NTSC or PAL, for your TV (p. 56).
	Shooting in Stitch Assist mode	<ul style="list-style-type: none"> • The output will not appear on a TV in Stitch Assist mode. Cancel the Stitch Assist mode.
Zoom does not operate	Zoom lever was pressed while shooting in movie mode.	<ul style="list-style-type: none"> • Operate the zoom before shooting in movie mode.
Reading images from SD card is slow	SD card was formatted in another device	<ul style="list-style-type: none"> • Use an SD card formatted in your camera. ➡ See <i>Formatting SD Cards</i> (p. 28).
Recording images to SD card takes a long time		

Using an AC Adapter Kit (Sold Separately)

It is best to power the camera with AC Adapter Kit ACK-DC10 (sold separately) when you are using it for long periods of time or connecting it to a computer.



Turn the camera power off before connecting or disconnecting the AC adapter.

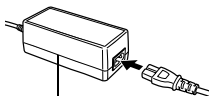

Compact Power Adapter
CA-DC10

- 1 Connect the power cord to the compact power adapter first and then plug the other end into the power outlet.**

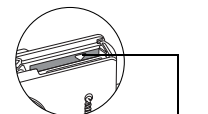

Battery Lock ▲ Symbol

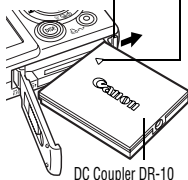

DC Coupler DR-10

- 2 Open the SD card slot/battery cover, then insert the DC coupler until it is locked.**

Press the battery lock in the direction of the arrow and hold it while aligning the ▲ on the DC coupler and battery chamber and insert the DC coupler correctly.

- Slide the SD card slot/battery cover closed.

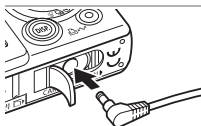

- 3 Open the DC coupler terminal cover and attach the cord to the DC terminal.**

After you have finished using the camera, unplug the AC adapter from the power outlet.



Use of an AC adapter kit other than ACK-DC10 (sold separately) may cause a malfunction in the camera or kit.

Camera Care and Maintenance

Use the following procedures to clean the camera body, lens and LCD monitor.



Never use thinners, benzene, synthetic cleansers or water to clean the camera. These substances may distort or damage the equipment.

Camera Body

Gently wipe dirt off the camera body with a soft cloth or eyeglass lens wiper.

Lens

First use a lens blower brush to remove dust and dirt, then remove any remaining dirt by wiping the lens lightly with a soft cloth.



Never use synthetic cleansers on the camera body or lens. If dirt remains, contact the closest Canon Customer Support Help Desk as listed on the rear of this booklet or the European Warranty System (EWS) Booklet.

LCD Monitor

Use a lens blower brush to remove dust and dirt. If necessary, gently wipe with a soft cloth or an eyeglass lens wiper to remove stubborn dirt.



Never rub or press strongly on the LCD monitor. These actions may damage it or lead to other problems.

Specifications

All data is based on Canon's standard testing methods. Subject to change without notice.

DIGITAL IXUS 40 DIGITAL IXUS 30

(W): wide angle (T): telephoto

Camera Effective Pixels	DIGITAL IXUS 40: Approx. 4.0 million DIGITAL IXUS 30: Approx. 3.2 million
Image Sensor	DIGITAL IXUS 40: 1/2.5-inch CCD (Total number of pixels: Approx. 4.2 million) DIGITAL IXUS 30: 1/2.5-inch CCD (Total number of pixels: Approx. 3.3 million)
Lens	5.8 (W) – 17.4 (T) mm (35mm film equivalent: 35 (W) – 105 (T) mm) f/2.8 (W) – f/4.9 (T)
Digital Zoom	DIGITAL IXUS 40: Approx. 3.6x (Up to approx. 11x in combination with the optical zoom) DIGITAL IXUS 30: Approx. 3.2x (Up to approx. 10x in combination with the optical zoom)
Optical Viewfinder	Real-image zoom viewfinder
LCD Monitor	2.0-inch, low-temperature polycrystalline silicon TFT color LCD, approx. 118,000 pixels (Picture coverage 100%)
AF System	TTL autofocus Focusing frame: 9-point AiAF/1-point AF (fixed to center)
Shooting Distance (From the front of the lens)	Normal AF: 30 cm (1.0 ft.) – infinity Macro AF: 3 – 50 cm (W)/30 – 50 cm (T) (1.2 in. – 1.6 ft. (W)/1.0 – 1.6 ft. (T))
Shutter	Mechanical shutter + electronic shutter

Shutter Speeds	15 – 1/1500 sec. The shutter speed varies according to the shooting mode. Slow shutter speeds of 1.3 sec. or slower operate with noise reduction.
Light Metering System	Evaluative, Center-weighted average or Spot (Center)
Exposure Control System	Program AE
Exposure Compensation	± 2.0 stops in 1/3-stop increments
Sensitivity	Auto*, ISO 50/100/200/400 equivalent *Camera automatically sets the optimal speed.
White Balance	TTL auto, pre-set (available settings: Daylight, Cloudy, Tungsten, Fluorescent or Fluorescent H) or custom
Built-in Flash	Auto*, on*, off, slow-synchro *Red-eye reduction is available.
Flash Range	Normal: 50 cm – 3.5 m (1.6 – 11.5 ft.) (W), 50 cm – 2.0 m (1.6 – 6.6 ft.) (T) Macro: 30 cm – 50 cm (1.0 – 1.6 ft.) (W/T) (When sensitivity is set to AUTO.)
Shooting Modes	Auto, Manual*, Digital macro, Portrait, Night snapshot, Kids&pets, Indoor, Underwater, Stitch assist**, Movie *Long shutter mode available **Selectable from the Rec. menu
Continuous Shooting	DIGITAL IXUS 40: Approx. 2.4 shots/sec. DIGITAL IXUS 30: Approx. 2.8 shots/sec. (Large/Fine mode with LCD monitor off)
Self-timer	Activates shutter after an approx. 10-sec./approx. 2-sec. delay
Recording Media	SD memory card
File Format	Design rule for camera file system and DPOF compliant
Image Recording Format	Still images: Exif 2.2 (JPEG)* ¹ Movies: AVI (Image data: Motion JPEG; Audio data: WAVE (monaural))
Compression	Superfine, Fine, Normal















Number of Recording Pixels	<p>Still images: DIGITAL IXUS 40:</p> <p>Large: 2272 x 1704 pixels</p> <p>Medium 1: 1600 x 1200 pixels</p> <p>Medium 2: 1024 x 768 pixels</p> <p>Small: 640 x 480 pixels</p> <p>DIGITAL IXUS 30:</p> <p>Large: 2048 x 1536 pixels</p> <p>Medium 1: 1600 x 1200 pixels</p> <p>Medium 2: 1024 x 768 pixels</p> <p>Small: 640 x 480 pixels</p>
	<p>Movies: Standard: (can record until the SD card is full) *¹</p> <p>640 x 480 pixels (30 frames/sec., 15 frames/sec.)</p> <p>320 x 240 pixels (30 frames/sec., 15 frames/sec.)</p> <p>Fast Frame Rate: (can record for 1 min.) *²</p> <p>320 x 240 pixels (60 frames/sec.)</p> <p>Compact: (can record for 3 min.) *²</p> <p>160 x 120 pixels (15 frames/sec.)</p>
	<p>*¹ Using high-speed SD cards (SDC-512MSH recommended).</p> <p>*² The data in parentheses refer to the maximum movie clip length.</p>
Playback Modes	<p>Single (histogram displayable), Index (9 thumbnail images), Magnified (approx. 10x (max.) in LCD monitor, advance or reverse through magnified images possible), Sound memos (up to 60 sec.), Slide show or Movie (slow motion play back possible).</p>
Direct Print	<p><i>Canon Direct Print</i> and <i>Bubble Jet Direct</i> compatible, and <i>PictBridge</i> compliant</p>
Display Languages	<p>21 languages available for menus and messages (English, German, French, Dutch, Danish, Finnish, Italian, Norwegian, Swedish, Spanish, Simplified Chinese, Russian, Portuguese, Greek, Polish, Czech, Hungarian, Turkish, Traditional Chinese, Korean and Japanese)</p>
My Camera Settings	<p>The start-up image, start-up sound, operation sound, self-timer sound, and shutter sound can be customized using the following methods:</p> <ol style="list-style-type: none"> 1. Using the images and sounds recorded on a camera. 2. Using the downloaded data from your computer using the supplied software.

Interface	USB (mini-B), PTP (Picture Transfer Protocol) Audio/Video output (NTSC or PAL selectable, monaural audio)
Power Source	Rechargeable lithium-ion battery (type: NB-4L) AC Adapter Kit ACK-DC10
Operating Temperature	0 – 40 °C (32 – 104 °F)
Operating Humidity	10 – 90%
Dimensions (excluding protrusions)	DIGITAL IXUS 40: 86.0 x 53.0 x 20.7 mm (3.4 x 2.1 x 0.82 in.) Thinnest section: 19.5 mm (0.77 in.) DIGITAL IXUS 30: 85.8 x 53.4 x 21.1 mm (3.4 x 2.1 x 0.83 in.) Thinnest section: 19.9 mm (0.78 in.)
Weight (camera body only)	DIGITAL IXUS 40: Approx. 130 g (4.59 oz.) DIGITAL IXUS 30: Approx. 115 g (4.06 oz.)

- *1 This digital camera supports Exif 2.2 (also called “Exif Print”). Exif Print is a standard for enhancing the communication between digital cameras and printers. By connecting to an Exif Print-compliant printer, the camera’s image data at the time of shooting is used and optimized, yielding extremely high quality prints.













SD Cards and Estimated Capacities

Still Images : With card included with the camera

		SDC-16M	SDC-128M	SDC-512MSH
L (2272 x 1704 pixels) DIGITAL IXUS 40		6	61	237
		12	109	425
		24	217	838
L (2048 x 1536 pixels) DIGITAL IXUS 30		8	74	295
		15	136	529
		30	269	1041
M1 (1600 x 1200 pixels)*		13	121	471
		24	217	838
		46	411	1590
M2 (1024 x 768 pixels)*		23	211	816
		42	372	1438
		74	652	2517
S (640 x 480 pixels)*		52	460	1777
		80	711	2746
		127	1118	4316

* Same for both the DIGITAL IXUS 40 and the DIGITAL IXUS 30 models.

Movie

			SDC-16M	SDC-128M	SDC-512MSH
 Standard	 (640 x 480 pixels)		6 sec.	1 min. 4 sec.	4 min. 9 sec.
			14 sec.	2 min. 7 sec.	8 min. 14 sec.
	 (320 x 240 pixels)		20 sec.	3 min. 1 sec.	11 min. 42 sec.
			40 sec.	5 min. 55 sec.	22 min. 53 sec.
 Fast Frame Rate	 (320 x 240 pixels)		10 sec.	1 min. 32 sec.	5 min. 59 sec.
 Compact	 (160 x 120 pixels)		1min. 38 sec.	14 min. 29 sec.	55 min. 57 sec.















- Maximum movie clip length at  (Fast Frame Rate): 1 min., at  (Compact): 3 min. The figures indicate the maximum continuous recording time.
- **L** (Large), **M1** (Medium 1), **M2** (Medium 2), **S** (Small), ,  and  indicate the recording resolution.
-  (Superfine),  (Fine) and  (Normal) indicate the compression setting.
- ,  and  indicate the number of frames per second.













Image File Sizes (Estimated)

Still Images

Resolution	Compression		
			
L (2272 x 1704) DIGITAL IXUS 40	2002 KB	1116 KB	556 KB
L (2048 x 1536) DIGITAL IXUS 30	1602 KB	893 KB	445 KB
M1 (1600 x 1200)*	1002 KB	558 KB	278 KB
M2 (1024 x 768)*	570 KB	320 KB	170 KB
S (640 x 480)*	249 KB	150 KB	84 KB

* Same for both the DIGITAL IXUS 40 and the DIGITAL IXUS 30 models.

Movie

	Resolution	Frame Rate	
 Standard	 (640 x 480 pixels)		1980 KB
			990 KB
	 (320 x 240 pixels)		660 KB
			330 KB
 Fast Frame Rate	 (320 x 240 pixels)		1320 KB
 Compact	 (160 x 120 pixels)		120 KB

Battery Capacity (Battery Pack NB-4L (Fully charged))

Number of Images Shot		Playback Time
LCD Monitor ON (Based on the CIPA standard)	LCD Monitor Off	
Approx. 140 images	Approx. 400 images	Approx. 180 minutes

- The actual figures will vary according to the shooting conditions and settings.
- Movie data is excluded.
- At low temperatures, the battery pack performance may diminish and the low battery icon appears very rapidly. In these circumstances, the performance can be improved by warming the battery pack in a pocket before use.

Test Conditions

Shooting: Normal temperature ($23\text{ }^{\circ}\text{C} \pm 2\text{ }^{\circ}\text{C}/73\text{ }^{\circ}\text{F} \pm 3.6\text{ }^{\circ}\text{F}$), normal relative humidity ($50\% \pm 20\%$), alternating wide angle end and telephoto end shots at 30 second intervals with the flash fired once every two shots and the camera power turned off after every tenth shot.

Power is left off for a sufficient amount of time*, then the power is turned back on and the testing procedure is repeated.

- The included memory card is used.

*Until the battery returns to normal temperature

Playback: Normal temperature ($23\text{ }^{\circ}\text{C} \pm 2\text{ }^{\circ}\text{C}/73\text{ }^{\circ}\text{F} \pm 3.6\text{ }^{\circ}\text{F}$), normal relative humidity ($50\% \pm 20\%$), continuous playback at 3 seconds per image.



See *Battery Pack Handling Precautions* (p. 22).

SD Memory Card

Interface	Compatible with SD memory card standards
Dimensions	32.0 x 24.0 x 2.1 mm (1.3 x 0.9 x 0.1 in.)
Weight	Approx. 2 g (0.1 oz.)

Battery Pack NB-4L

Type	Rechargeable lithium-ion battery
Nominal Voltage	3.7 V
Typical Capacity	760 mAh
Cycle Life	Approx. 300 times
Operating Temperatures	0 – 40 °C (32 – 104 °F)
Dimensions	35.4 x 40.3 x 5.9 mm (1.4 x 1.6 x 0.23 in.)
Weight	Approx. 17 g (0.6 oz.)

Battery Charger CB-2LV/CB-2LVE

Rated Input	100 – 240 V AC (50/60 Hz)
	10 VA (100 V) - 14 VA (240 V) (CB-2LV)
	0.1 A (100 V) - 0.06 A (240 V) (CB-2LVE)
Rated Output	4.2 V DC/0.65 A
Charging Time	Approx. 90 minutes
Operating Temperatures	0 to 40 °C (32 to 104 °F)
Dimensions	53.0 x 86.0 x 19.5 mm (2.1 x 3.4 x 0.77 in.)
Weight	Approx. 60 g (2.1 oz.) (CB-2LV)
	Approx. 55 g (1.9 oz.) (CB-2LVE)

Compact Power Adapter CA-DC10

(Included with the separately sold AC Adapter Kit ACK-DC10)

Rated Input	100 – 240 V AC (50/ 60 Hz)
	0.17 A
Rated Output	4.3 V DC/1.5 A
Operating Temperatures	0 – 40 °C (32 – 104 °F)
Dimensions	42.6 x 104.4 x 31.4 mm (1.7 x 4.1 x 1.2 in.)
Weight	Approx. 180 g (6.3 oz.)

Photo Tips and Information

Tip for Using the Self-timer (p.76)

Normally the camera shakes a little when you press the shutter button. Setting the self-timer to  delays the shutter release for 2 seconds and allows the camera to stop shaking, thus preventing a blurred image. Even better results can be obtained by placing the camera on a stable surface or by using a tripod to shoot.

How to Adjust the Exposure (p.91)

This camera automatically adjusts the exposure to shoot images with the optimal brightness. However, recorded images may sometimes be brighter or darker than the actual image depending on the shooting conditions. If this happens, adjust the exposure compensation manually.



Underexposure

The whole recorded image is dark, which makes white elements of the image appear gray. Shooting bright subjects or in backlit conditions may cause the image to be underexposed. Adjust the exposure compensation towards the + end.



Optimal Exposure



Overexposure

The whole recorded image is bright, which makes black elements of the image appear gray. Shooting dark subjects or in dark places may cause the image to be overexposed. Adjust the exposure compensation towards the - end.

ISO Speed (p.98)

The ISO speed is the numeric representation of the camera's sensitivity to light. The higher the ISO speed, the higher the sensitivity. A high ISO speed allows you to shoot images in dark indoor or outdoor conditions without a flash and also helps prevent blurred images due to camera shake. This is convenient when shooting images in places where flash photography is prohibited. The ISO speed setting makes full use of the available light, resulting in images that convey the feel of the place they were shot.



ISO 50 equivalent



ISO 400 equivalent

Advanced Technique for the Macro mode (p.68)

Macro mode can make unique images when used with the zoom function. For example, shooting a flower at maximum wide angle in Macro mode allows the camera to bring both the flower and the background into focus. However, shooting at maximum telephoto can throw the background out of focus to make the flower stand out.



Macro with the wide angle zoom



Macro with the telephoto zoom

Digital Macro

When using digital macro, you can make a subject even larger than in the normal macro mode. You can enjoy seeing characteristics of a subject in your photos that might escape the naked eye.

Image Comparison



Standard Mode
(Subject Distance:
30 cm (1.0 ft.))



Macro Mode
(Subject Distance: 3 cm
(1.2 in.))

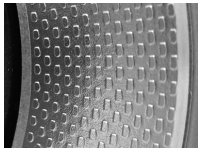

Digital Macro Mode
(Subject Distance: 3 cm
(1.2 in.))
Digital Zoom: Approx.
3.6x for DIGITAL IXUS
40

A

AC Adapter Kit ACK-DC10	154
AE Lock	88
AF Frame	47
AF Lock	87
AF-assist Beam.....	48
AiAF.....	45
Auto Play (Slide Show).....	114
Auto Rotate Function.....	99
Autofocus	45
AV Cable AVC-DC300	140

B

Battery	
Capacity.....	162
Charging.....	21
Handling	22
Installing	24

C

Clock Display.....	33
Compression	62
Computer System Requirements	
.....	133
Connecting the Camera to a Com-	
puter.....	132
Continuous Shooting.....	73
Custom White Balance	95

D

Date/Time	31
DIGITAL Terminal.....	134
Digital Zoom.....	72
Direct Interface Cable	20
Direct Transfer	137
DPOF Print Order.....	124
Print Style.....	128
Selecting Images.....	124
DPOF Transfer Order	130

E

Erasing	119
All Images	120
Single Images	119
Exposure	91

F

FE Lock	89
File Number.....	100
Flash.....	64
Focus Lock.....	86
FUNC. Menu.....	50

H

Histogram	44
-----------------	----

I

Image File Sizes	161
Index Playback	105
Indicator.....	19, 36
Infinity	68
Interface Cable	134
ISO Speed	98

L

Language	34
LCD Monitor.....	39
Information Displayed	41
Using the LCD Monitor.....	39

M

Macro	68
Magnifying	104
Menu	
Menu Settings and Factory	
Defaults	53
My Camera Menu	57
Play Menu	54
Rec. Menu	53
Set up Menu.....	54
Messages	148

Metering Modes.....	90
Mode switch	38
Movie.....	78
Editing	109
Playback	106
Shooting	78
Mute Mode	54
My Camera Menu	
Changing	142
Registering	144
My Camera Settings.....	142
File Format.....	146

O

ON/OFF Button.....	36
--------------------	----

P

Photo Effect	97
Play Menu.....	54
Playback Mode	38
Postcard Date Imprint Mode.....	74
Power-saving.....	37
Print/Share Button	15, 18
Protect.....	118

R

Rec. Menu	53
Red-Eye Reduction Function.....	65
Resolution	62
Review Duration	61
Rotate	111

S

SD Card	26
Capacities	160
Formatting	28
Handling	30
Installing.....	26
Self-Timer	76
Set up Menu	54

Shooting Mode

Auto	59
Digital Macro	70
Functions Available in Each Shooting Mode	176
Indoor	66
Kids&Pets.....	66
Manual.....	66
Night Snapshot	66
Portrait	66
Stitch Assist.....	82
Underwater	66
Shutter Button	47
Pressing Fully	48
Pressing Halfway	47
Shutter Speed.....	92
Single Image Playback.....	103
Slide Show	
Play Time.....	117
Repeat Settings	117
Sound Memo	112
Spot AE Point Frame.....	42, 90

T

Telephoto.....	46
----------------	----

U

USB port.....	134
---------------	-----

V

Video Output System	141
---------------------------	-----

W

White Balance.....	94
Wide Angle	46
Wrist Strap	13, 16

MEMO

MEMO

MEMO

MEMO

MEMO

Disclaimer

- While every effort has been made to ensure that the information contained in this guide is accurate and complete, no liability can be accepted for any errors or omissions.
- Canon reserves the right to change the specifications of the hardware and software described herein at anytime without prior notice.
- No part of this guide may be reproduced, transmitted, transcribed, stored in a retrieval system, or translated into any language in any form, by any means, without the prior written permission of Canon.
- Canon makes no warranties for damages resulting from corrupted or lost data due to a mistaken operation or malfunction of the camera, the software, SD memory cards (SD cards), personal computers, peripheral devices, or use of non-Canon SD cards.

Trademark Acknowledgments

- Canon, PIXMA and SELPHY are trademarks of Canon Inc.
- Macintosh, Mac OS and QuickTime are trademarks of Apple Computer Inc., registered in the United States and/or other countries.
- Microsoft® and Windows® are either registered trademarks or trademarks of Microsoft Corporation in the United States and/or other countries.
- SD is a trademark.
- Other names and products not mentioned above may be registered trademarks or trademarks of their respective companies.

Functions Available in Each Shooting Mode

The chart below is a reference for the settings available for various shooting conditions. The settings selected in each shooting mode are saved after you finish shooting.

Function		Shooting							Movie	Page	
Resolution	Large		○*	○*	○*	○*	○*	○*	△*	-	p. 62
	Medium 1		○	○	○	○	○	○	△	-	
	Medium 2		○	○	○	○	○	○	△	-	
	Small		○	○	○	○	○	○	△	-	
	Postcard		○	○	-	○	○	○	-	-	
	Movie		-	-	-	-	-	-	-	○ ⁽¹⁾	
Compression	Superfine		○	○	○	○	○	○	△	-	p. 62
	Fine		○*	○*	○*	○*	○*	○*	△*	-	
	Normal		○	○	○	○	○	○	△	-	
Frame Rate			-	-	-	-	-	-	-	○ ⁽²⁾	p. 81
Flash	Auto		○	○	-	○	○	○*	-	-	p. 64
	Auto with Red-Eye Reduction		○*	○*	-	○*	○*	○	-	-	
	On with Red-Eye Reduction		-	-	-	○	○	○	-	-	
	On		-	○	-	○	○	○	△	-	
	Off		○	○	○*	○	○	○	△*	-	
	Slow Synchro		-	○	-	- ⁽³⁾	-	-	△	-	
Macro Mode			○	○	-	○	-	○	△	○	p. 68
Infinity Mode			-	○	-	○	-	○	△	○	
AF Lock			-	○	○	-	-	-	-	-	p. 86
AE Lock			-	○	○	-	-	-	-	-	p. 88
FE Lock			-	○	-	-	-	-	-	-	p. 89
Shooting Method	Single		○*	○*	○*	○*	○*	○*	△*	○*	-
	Continuous shooting		-	○	○	○	○	○	-	-	p. 73
	10-sec. self-timer		○	○	○	○	○	○	△	○	p. 76
	2-sec. self-timer		○	○	○	○	○	○	△	○	
Date Stamp			○	○	-	○	○	○	-	-	p. 75

Function	Shooting							Movie	Page
Autofocus Modes	-	○	○	○	-	○	-	-	p. 85
AF-assist Beam	○	○	○	○	○	○	△	○	p. 48
Digital Zoom	○	○	-	○	○	○	-	-	p. 46
Light Metering Method	Evaluative	-	○*	○*	-	-	-	-	p. 90
	Center-Weighted Average	-	○	○	-	-	-	-	
	Spot	-	○	○	-	-	-	-	
Exposure Compensation	-	○	○	○	○	○	△	○ ⁽⁴⁾	p. 91
Long Shutter	-	○	-	-	-	-	-	-	p. 91
White Balance	-	○	○	- ⁽⁵⁾	- ⁽⁵⁾	- ⁽⁵⁾	△	○	p. 94
Photo Effect	-	○	○	- ⁽⁵⁾	- ⁽⁵⁾	- ⁽⁵⁾	△	○	p. 97
ISO Speed	- ⁽⁵⁾	○	○	- ⁽⁵⁾	- ⁽⁵⁾	- ⁽⁵⁾	- ⁽⁵⁾	- ⁽⁵⁾	p. 98
Auto Rotate	○	○	○	○	○	○	△	-	p. 99

* Default setting

○ Setting available △ Setting can only be selected for the first image.

■ (Shaded Area): Setting is memorized even when the camera power is shut off.

With the exception of the [Date/Time], [Language] and [Video System] settings, all the other menu settings and changes made with the camera buttons can be reset to the default values in a single operation (p. 58).

(1) (2) The resolutions and frame rates for the (Movie) mode are as follows.

		Standard	Fast Frame Rate	Compact
Resolution	640 x 480 pixels	○*	-	-
	320 x 240 pixels	○	○	-
	160 x 120 pixels	-	-	○
Frame Rate	60 frames/sec.	-	○	-
	30 frames/sec.	○*	-	-
	15 frames/sec.	○	-	○

⁽³⁾ In (Night Snapshot) mode, the flash will automatically fire in Slow Synchro mode.

⁽⁴⁾ Can be set after locking exposure (AE lock).

⁽⁵⁾ Automatically set by the camera.

Canon

CANON INC.

30-2 Shimomaru-ku 3-chome, Ohta-ku, Tokyo 146-8501, Japan

Europa, Africa & Middle East

CANON EUROPA N.V.

PO Box 2262, 1180 EG Amstelveen, The Netherlands

CANON (UK) LTD

For technical support, please contact the Canon Help Desk:

P.O. Box 431, Wallington, Surrey, SM6 0XU, UK

Tel: (08705) 143723 Fax: (08705) 143340

<http://www.canon.co.uk/Support/index.asp>

CANON COMMUNICATION & IMAGE FRANCE S.A.

102 Avenue du Général de Gaulle,

92257 LA GARENNE COLOMBES CEDEX, France

Tel: Hotline 08 25 00 29 23

<http://www.cci.canon.fr>

CANON DEUTSCHLAND GmbH

Postfach 100401, 47704 Krefeld, Germany

Customer Hotline: 0180/5006022 (0,12 €/ Min.)

<http://www.canon.de>

CANON ITALIA S.P.A.

Via Milano 8, I-20097 San Donato Milanese (MI), Italy

Tel: 02/8248.1 Fax: 02/8248.4604

Pronto Canon: 02/8249.2000

E-mail: supporto@canon.it

<http://www.canon.it>

CANON ESPAÑA S.A.

C/Joaquín Costa, 41 - 28002 Madrid, Spain

Tel. Atención al Cliente: 901.301.301

Helpdesk: 906.301.255

<http://www.canon.es>

CANON BELGIUM N.V. / S.A.

Bessenveldstraat 7, B - 1831 Diegem, Belgium

Tel: (02) 722.04.11 Fax: (02) 721.32.74

Helpdesk : 0900-10627

<http://www.canon.be>

CANON LUXEMBOURG S.A.

Rue des Jons 21, L-1818 Howald, Luxembourg

Tel: (0352) 48 47 961 Fax: (0352) 48 47 96232

Helpdesk : 900-74100

<http://www.canon.lu>

CANON NEDERLAND N.V.

Neptunusstraat 1, 2132 JA Hoofddorp, The Netherlands

Tel: 023 - 5 670 123 Fax: 023 - 5 670 124

Helpdesk: 023 - 5 681 681

<http://www.canon.nl>

CANON DANMARK A/S

Knud Højgaards Vej 1, DK-2860 Søborg, Denmark

Tel: +45 44 88 26 66

<http://www.canon.dk>

CANON NORGE AS

Hallagerbakken 110, Postboks 33, Holmlia, 1201 Oslo, Norway

Tel: 22 62 93 21

Fax: 22 62 06 15

E-mail: helpdesk@canon.no

<http://www.canon.no>

Finland

CANON OY

Kuluttajatuotteet

Huopalahdentie 24, PL1

00351 Helsinki, Finland

Helpdesk: 020 366 466 (pvm)

<http://www.canon.fi>

CANON SVENSKA AB

Gustav III:s Boulevard 26, S-169 88 Solna, Sweden

Helpdesk: 08-744 8620

Fax 08-744 8527

<http://www.canon.se>

CANON (SCHWEIZ) AG

Industriestrasse 12, 8305 Dietlikon, Switzerland

Consumer Imaging Group

Tel. 01-835-61 61

Hotline 0848 833 838 (CHF 2.13/min)

<http://www.canon.ch>

Austria

CANON GES. M.B.H.

Zetschegasse 11, A - 1230 Wien, Austria

Helpdesk Tel.: 01 66 146 412

Fax: 01 66 146 413

<http://www.canon.at>

Portugal

SEQUE - SOC. NAC. EQUIP., S.A.

Pr. Alegria, 58 - 2ºC, 1269-149 Lisboa, Portugal

Tel: (+351) 21 324 28 30

Fax: (+351) 21 347 27 51

E-mail: info@seque.pt

<http://www.seque.pt>

Eastern Europe

CANON CEE GMBH

Oberlaaerstr 233, A-1100 Wien, Austria

Tel: +43 1 680 88-0

Fax: +43 1 680 88-422

CIS

CANON NORTH-EAST OY

Huopalahdentie 24, 00350 Helsinki, Finland

Tel: +358 10 544 00

Fax: +358 10 544 10

<http://www.canon.ru>