

# OPT7

## EASY CONNECT

### DUAL 7-PIN SPLITTER TO 4-PIN ADAPTER HARNESS with REVERSE WIRE

This wiring harness allows you to use an existing 7-Pin to 4-Pin Connector without splicing or cutting. Easy installation made for all vehicles!

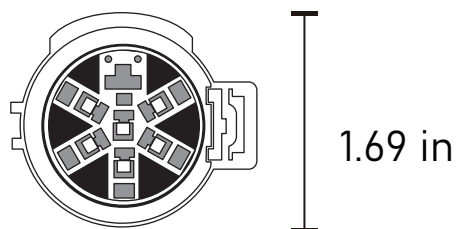
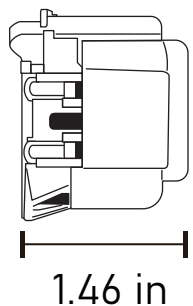
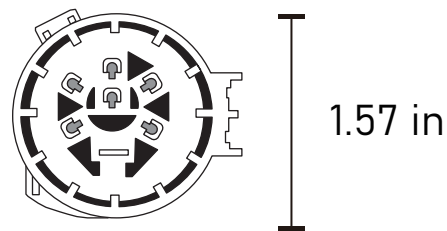
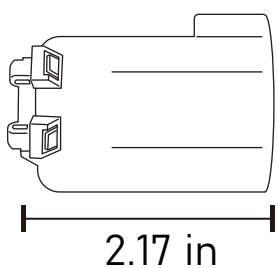
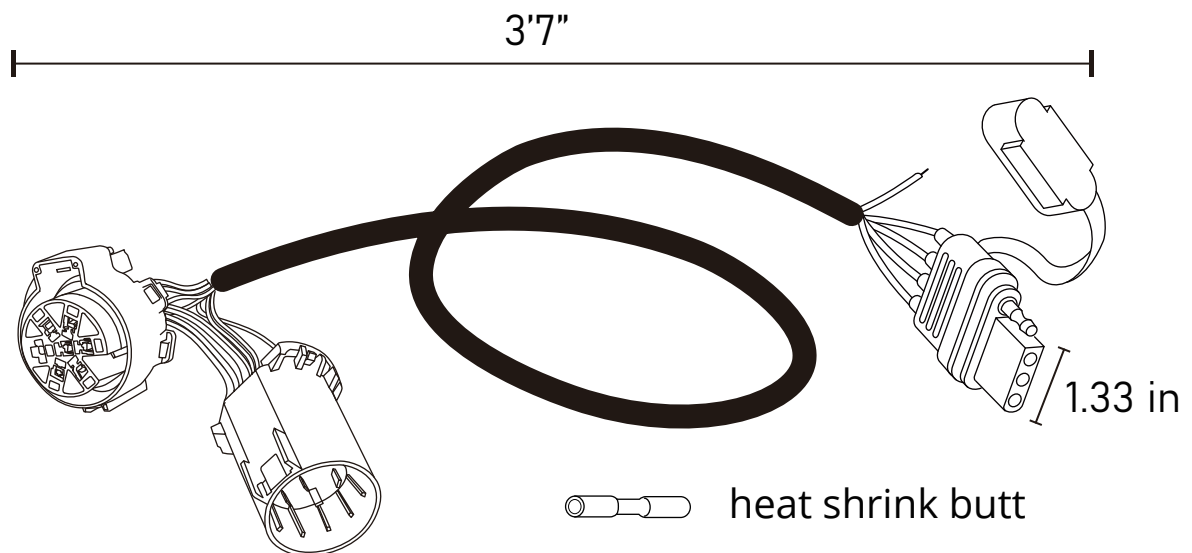

# INSTALLATION

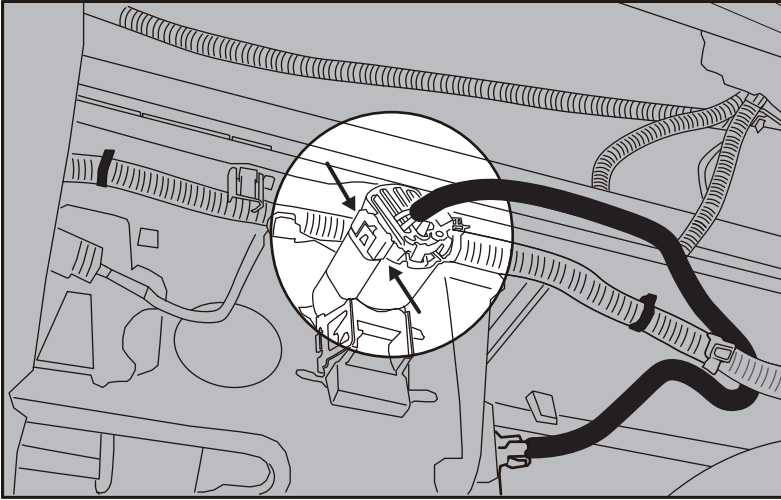

## STEP 1

Find the OEM 7-Pin plug beneath the truck. Use caution when unplugging the socket.

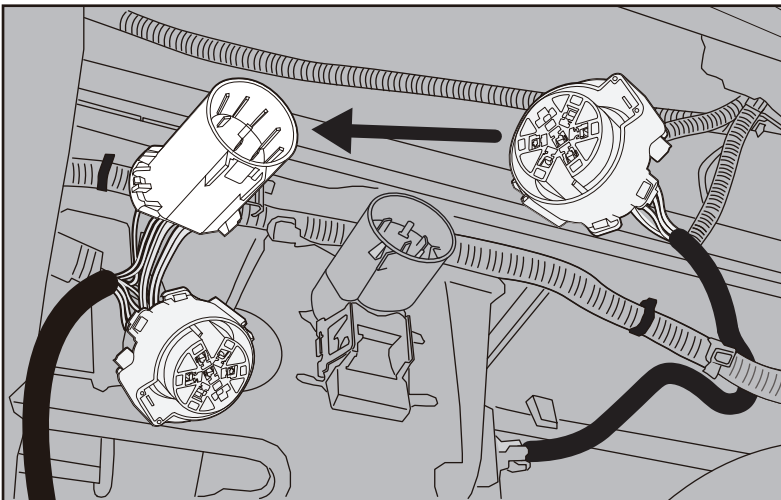

## STEP 2

Attach the OEM 7-Pin plug to the OPT7 7-Pin to 4-Pin Adapter Harness. Make sure the pins align and securely clip into place.

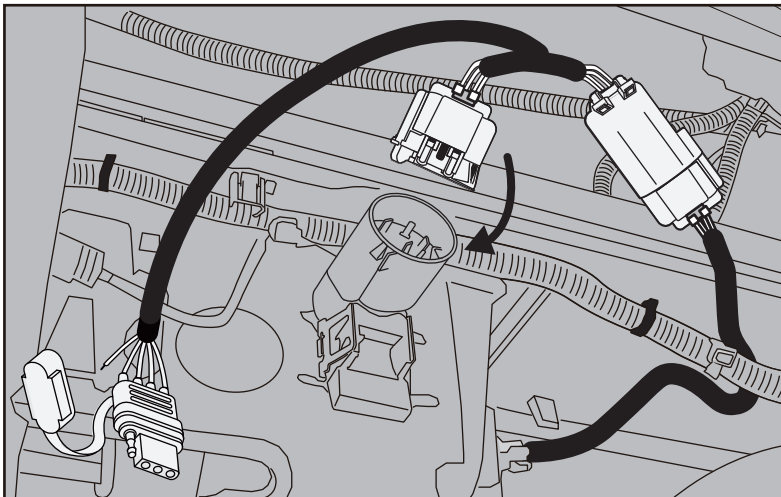

## STEP 3

Next, plug the OPT7 7-Pin to 4-Pin Harness Adapter back into the OEM 7-Pin plug.

# INSTALLATION

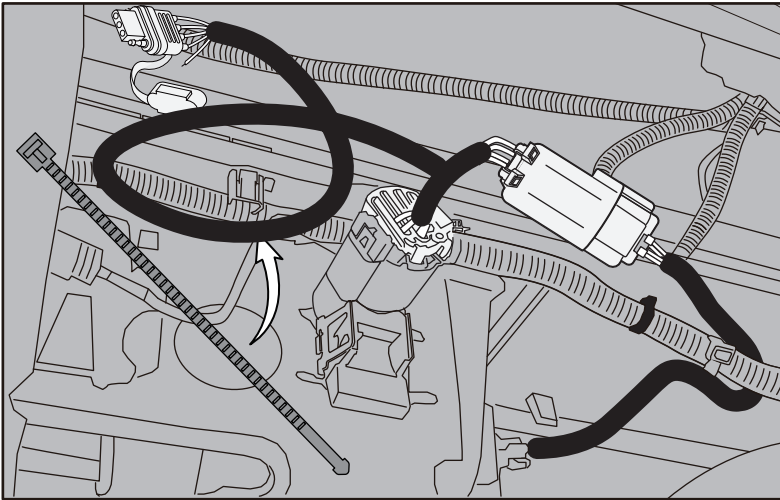

## STEP 4

Make sure the OPT7 7-Pin to 4-Pin Harness Adapter works properly by connecting the 4-Pin end to the Redline Light Bar. (not including \*reverse wiring)

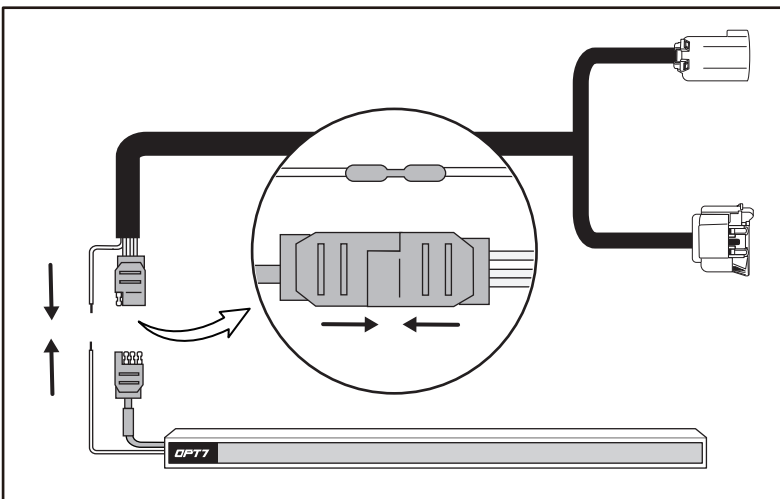

## STEP 5

Securely zip-tie all wires and guide the 4-Pin Plug to connect with the Redline Light Bar. Hardwire the white wire from the Redline Light Bar to the reverse wire of the 7-pin to the 4-pin using a **heat shrink butt**. Tuck wires away from heated surfaces and neatly secure them.

## HOW TO CONNECT TO YOUR VEHICLE ?

The diagrams are the recommend installation method for the Redline Triple Tailgate Light Bar. Please confirm the year model and make of your vehicle before installing. Feel free to contact us using the link below for product inquiries or installation support.

OPT7 Support Team: //

<https://www.opt-7.com/pages/customer-support>

OPT7 Redline Tailgate Light Bar: //

<https://support.opt-7.com/716730-Redline-LED-Tailgate-Bar-Series>

OPT7®

# OPTIONAL APPLICATION

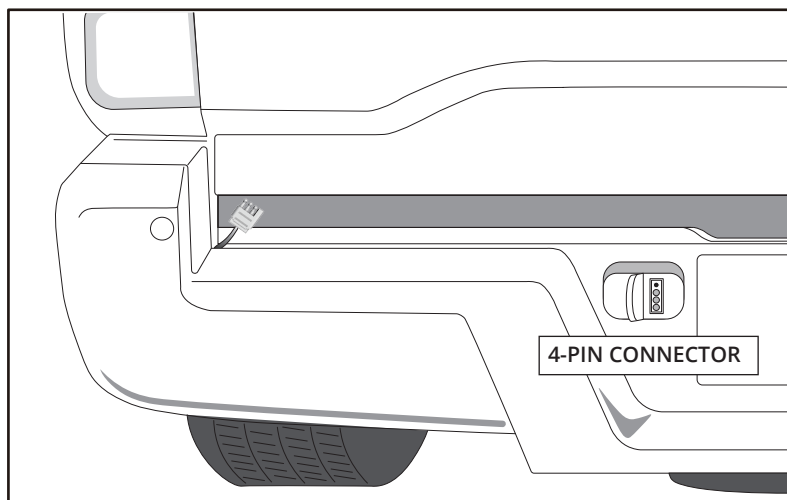

## 4 PIN PLUG AND PLAY

Provides an additional option for vehicles, the flat 4 Pin trailer wiring is commonly used on various trailers, offering versatile towing options for your vehicle, including turn signals.

### VEHICLE FIT PLUG AND PLAY

2005-2014 Ford F150  
2005-2014 Ram 1500  
2005-2014 Chevrolet Silverado 1500  
2005-2014 GMC Sierra 1500  
2005-2022 Chevrolet Colorado  
2005-2022 GMC Canyon  
2005-2025 Toyota Tacoma  
2005-2025 Toyota Tundra

### NOT COMPATIBLE WITH PLUG AND PLAY

2015-2025 Ford F150  
2015-2025 Ram 1500  
2015-2025 Chevrolet Silverado 1500  
2015-2025 GMC Sierra 1500  
2023-2025 Chevrolet Colorado  
2023-2025 GMC Canyon  
2019-2025 Ford Ranger  
2022-2025 Ford Maverick

## DISCLAIMER

OPT7 Lighting is not liable for damages, injuries, or death while installing this product. The Installation Guide is intended as assistance to reduce setup time. OPT7 Lighting assumes no responsibility for improper installation. If you are unfamiliar with your vehicle or inexperienced with aftermarket upgrades, please seek professional assistance.