

# INDIRECT SOLAR WATER HEATERS

## INSTALLATION - OPERATION - MAINTENANCE

FOR POTABLE WATER HEATING ONLY



Solar Water Heater



Low Lead Content



### **⚠️ WARNING**

Read and understand this instruction manual and safety messages before installing, operating, or servicing this water heater.

Failure to follow these instructions and safety messages could result in death or serious injury.

This manual must remain with water heater.

**ALL TECHNICAL AND WARRANTY QUESTIONS:** SHOULD BE DIRECTED TO THE LOCAL DEALER FROM WHOM THE WATER HEATER WAS PURCHASED. IF YOU ARE UNSUCCESSFUL, PLEASE WRITE TO THE COMPANY LISTED ON THE RATING PLATE ON THE WATER HEATER.





**KEEP THIS MANUAL IN THE POCKET ON HEATER FOR FUTURE REFERENCE  
WHENEVER MAINTENANCE ADJUSTMENT OR SERVICE IS REQUIRED.**

# SAFE INSTALLATION, USE AND SERVICE

Your safety and the safety of others is extremely important in the installation, use, and servicing of this water heater.

Many safety-related messages and instructions have been provided in this manual and on your own water heater to warn you and others of a potential injury hazard. Read and obey all safety messages and instructions throughout this manual. It is very important that the meaning of each safety message is understood by you and others who install, use, or service this water heater.

	This is the safety alert symbol. It is used to alert you to potential personal injury hazards. Obey all safety messages that follow this symbol to avoid possible injury or death.
---	--

	<b>DANGER</b> indicates an imminently hazardous situation which, if not avoided, will result in death or injury.
	<b>WARNING</b> indicates a potentially hazardous situation which, if not avoided, could result in death or injury.
	<b>CAUTION</b> indicates a potentially hazardous situation which, if not avoided, could result in minor or moderate injury.
	<b>CAUTION</b> used without the safety alert symbol indicates a potentially hazardous situation which, if not avoided, could result in property damage.

All safety messages will generally tell you about the type of hazard, what can happen if you do not follow the safety message, and how to avoid the risk of injury.

---

## IMPORTANT DEFINITIONS

- **Qualified Installer:** A qualified installer must have ability equivalent to a licensed tradesman in the fields of plumbing and electrical installation of these appliances. This would include a thorough understanding of the requirements of the National Electrical Code and applicable local electrical and plumbing codes (and tools necessary to confirm proper installation and operation of the water heater) as they relate to the installation of electric water heaters. The qualified installer must have a thorough understanding of the water heater Instruction Manual.
- **Service Agency:** A service agency also must have ability equivalent to a licensed tradesman in the fields of plumbing and electrical installation of these appliances. This would include a thorough understanding of the requirements of the National Electrical Code and applicable local electrical and plumbing codes (and tools necessary to confirm proper installation and operation of the water heater) as they relate to the installation of electric water heaters. The service agency must have a thorough understanding of the water heater Instruction Manual.

# GENERAL SAFETY



## ⚠️ WARNING

Read and understand this instruction manual and safety messages before installing, operating, or servicing this water heater.

Failure to follow these instructions and safety messages could result in death or serious injury.

This manual must remain with water heater.

## CAUTION

**Improper installation and use may result in property damage.**

- Do not operate water heater if flood damaged.
- Inspect and replace anode.
- Install in location with drainage.
- Fill tank with water before operation.
- Be alert for thermal expansion.

Refer to this manual for installation and service.

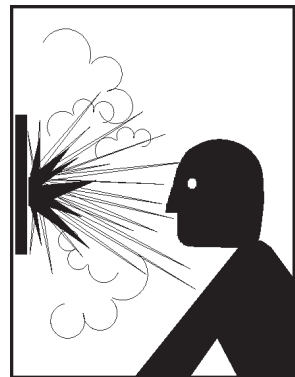

## ⚠️ WARNING

### Explosion Hazard

- Overheated water can cause water tank explosion.
- Properly sized temperature and pressure relief valve must be installed in opening provided.



## ⚠️ WARNING

- Before removing any access panels or servicing the water heater, make sure the electrical supply to the water heater is turned "OFF."
- Failure to do this could result in death, serious bodily injury, or property damage.

## ⚠️ DANGER

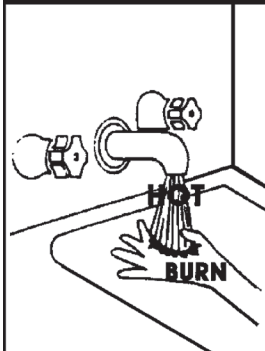

Water temperature over 125°F (52°C) can cause severe burns instantly resulting in severe injury or death.

Children, the elderly, and the physically or mentally disabled are at highest risk for scald injury.

Feel water before bathing or showering.

Temperature limiting valves are available.

Read this instruction manual for safe temperature setting.

## ⚠️ WARNING

### Fire Hazard / Electric Shock Hazard



- Do not use this water heater with any voltage other than shown on the model rating plate.
- Failure to use the correct voltage shown on the model rating plate could result in death, serious bodily injury, or property damage.



# INTRODUCTION

**Thank You** for purchasing this solar water heater. Properly installed and maintained, it should give you years of trouble free service.

## Abbreviations Found In This Instruction Manual:

- ANSI - American National Standards Institute
- ASME - American Society of Mechanical Engineers
- AHRI - Air-Conditioning, Heating, and Refrigeration Institute
- NEC - National Electrical Code
- NFPA - National Fire Protection Association
- UL - Underwriters Laboratories Inc.
- CSA - Canadian Standards Association

## PREPARING FOR THE INSTALLATION

1. Read the “General Safety” section of this manual first and then the entire manual carefully. If you don’t follow the safety rules, the solar water heater will not operate properly. It could cause DEATH, SERIOUS BODILY INJURY, AND/OR PROPERTY DAMAGE.

This manual contains instructions for the installation, operation, and maintenance of the electric water heater. It also contains warnings throughout the manual that you must read and understand. All warnings and all instructions are essential to the proper operation of the water heater and your safety. **READ THE ENTIRE MANUAL BEFORE ATTEMPTING TO INSTALL OR OPERATE THE SOLAR WATER HEATER.**

2. The installation must conform with these instructions and the local code authority having jurisdiction and the requirements of the power company. In the absence of local code requirements follow NFPA-70, the National Electrical Code (current edition), which may be ordered from: National Fire Protection Association, 1 Batterymarch Park, Quincy, MA 02269.
3. If after reading this manual you have any questions or do not understand any portion of the instructions, call the local utility or the manufacturer whose name appears on the rating plate.
4. Carefully plan your intended placement of the water heater. **INSTALLATION OR SERVICE OF THIS WATER HEATER REQUIRES ABILITY EQUIVALENT TO THAT OF A LICENSED TRADESMAN IN THE FIELD INVOLVED. PLUMBING AND ELECTRICAL WORK ARE REQUIRED.**

Examine the location to ensure the water heater complies with the “Facts to Consider About the Location” section in this manual.

5. For California installation this water heater must be braced, anchored, or strapped to avoid falling or moving during an earthquake. See instructions for correct installation procedures. Instructions may be obtained from California Office of the State Architect, 400 P Street, Sacramento, CA 95814.
6. Massachusetts Code requires this water heater to be installed in accordance with Massachusetts 248-CMR 2.00: State Plumbing Code and 248-CMR 5.00.

# TABLE OF CONTENTS

SAFE INSTALLATION, USE AND SERVICE.....	2	OPERATION.....	12
GENERAL SAFETY.....	3	Temperature Regulation.....	12
INTRODUCTION.....	4	Temperature Settings.....	12
Preparing for the Installation.....	4	Temperature Adjustment.....	12
TABLE OF CONTENTS.....	4	FOR YOUR INFORMATION.....	13
TYPICAL INSTALLATION.....	5	Thermal Expansion.....	13
LOCATING THE NEW SOLAR WATER HEATER.....	6	Strange Sounds.....	13
Facts to Consider About the Installation.....	6	Water Odor.....	13
Insulation Blankets.....	6	“Air” in Hot Water Faucets.....	13
INSTALLING THE NEW SOLAR WATER HEATER.....	6-11	High Temperature Shut Off System.....	13
Local Codes.....	6	MAINTENANCE.....	14-15
Temperature-Pressure Relief Valve.....	6-8	Draining & Flushing.....	14
Closed System/Thermal Expansion.....	8	Element.....	14
Locating the Solar Water Heater.....	8	Heating Element Replacement.....	14
Water Piping.....	8-10	Thermostat Removal / Replacement.....	14
Filling the Solar Water Heater with Water.....	10	Anode Rod Inspection.....	15
T&P Valve and Pipe Insulation (Selected Models).....	10	Temperature-Pressure Relief Valve Operation.....	15
Wiring of Element.....	10-11	Water Heater Sounds.....	15
Thermostat.....	11	REPAIR PARTS.....	16
Tank Sensor.....	11	Repair Parts Schedule.....	16



# TYPICAL INSTALLATION

Check all connections for leaks. Consult the local utility company to examine installation for propriety and safety.

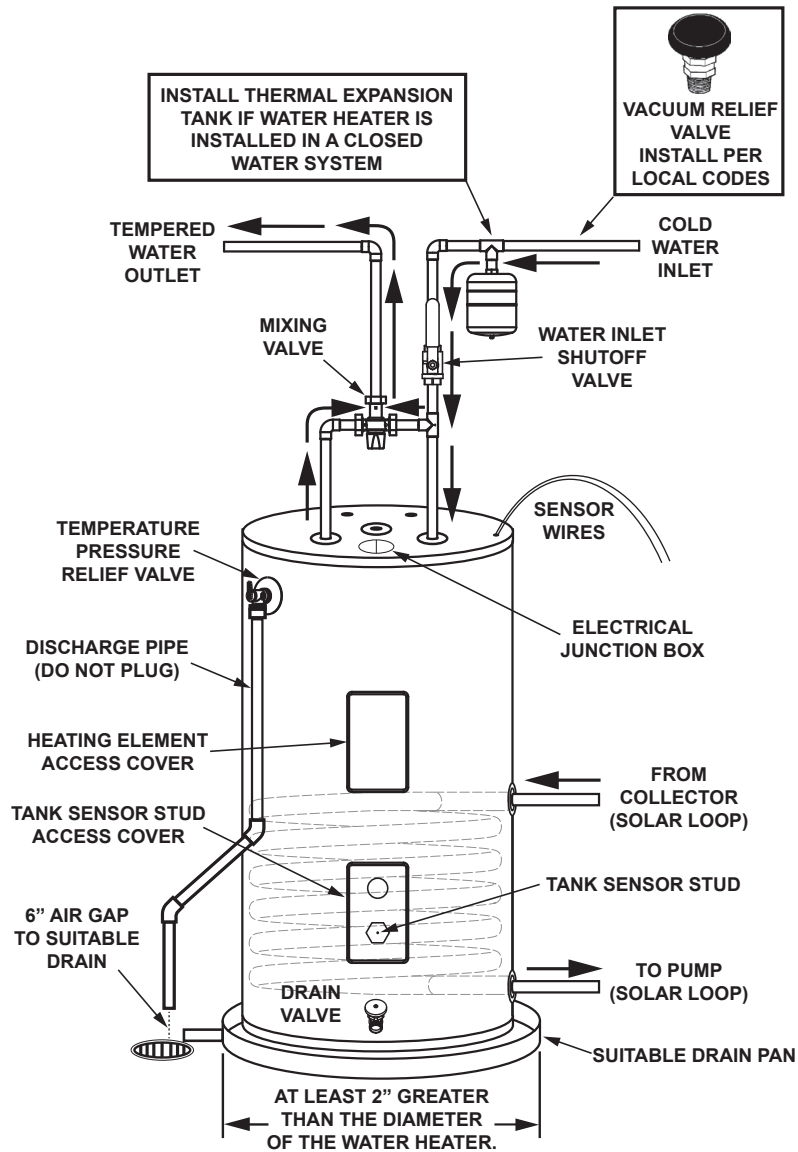

Figure 1.

**Water (Potable) Heating:** All models are considered suitable for water (potable) heating only.

## HOTTER WATER CAN SCALD:

Water heaters are intended to produce hot water. Water heated to a temperature which will satisfy space heating, clothes washing, dish washing, and other sanitizing needs can scald and permanently injure you upon contact. Some people are more likely to be permanently injured by hot water than others. These include the elderly, children, the infirm, or physically/mentally disabled. If anyone using hot water in your home fits into one of these groups or if there is a local code or state law requiring a certain temperature water at the hot water tap, then you must take special precautions. In addition to using the lowest possible temperature setting that satisfies your hot water needs, a means such as a mixing valve should be used at the hot water taps used by these people or at the water heater. Mixing valves are available from your local plumbing contractor. Consult a Qualified Installer or Service Agency. Follow mixing valve manufacturer's instructions for installation of the valves. Before changing the factory setting on the thermostat, read the "Temperature Regulation" section in this manual.

	<p>Water temperature over 125°F (52°C) can cause severe burns instantly resulting in severe injury or death.</p> <p>Children, the elderly, and the physically or mentally disabled are at highest risk for scald injury.</p> <p>Feel water before bathing or showering.</p> <p>Temperature limiting valves are available.</p> <p>Read this instruction manual for safe temperature setting.</p>
--	---

# LOCATING THE NEW SOLAR WATER HEATER

## FACTS TO CONSIDER ABOUT THE LOCATION

### CAUTION

#### Property Damage Hazard

- All water heaters eventually leak
- Do not install without adequate drainage.

Carefully choose an indoor location for the new solar water heater, because the placement is a very important consideration for the safety of the occupants in the building and for the most economical use of the water heater.

Whether replacing an old water heater or putting the water heater in a new location, the following critical points must be observed:

1. Select a location indoors as close as practical or centralized to the water piping system as possible. The solar water heater should be located in an area not subject to freezing temperatures.
2. Selected location must provide adequate clearances (4"/101.6 mm) for servicing parts such as the thermostats, drain valve, and relief valve. Adequate clearance for servicing this water heater should be considered before installation, such as changing the anodes, etc.
3. The solar water heater should be located so it is not subject to physical damage by moving vehicles or area flooding.

Installation of the solar water heater must be accomplished in such a manner that if the tank or any connections should leak, the flow will not cause damage to the structure. For this reason, it is not advisable to install the solar water heater in an attic or upper floor. When such locations cannot be avoided, a suitable metal drain pan should be installed under the solar water heater. Drain pans are available from your local plumbing contractor.

Such a drain pan must have a minimum length and width of at least 2 inches (51 mm) greater than the water heater dimensions and must be piped to an adequate drain.

Water heater life depends upon water quality, water pressure and the environment in which the water heater is installed. Water heaters are sometimes installed in locations where leakage may result in property damage, even with the use of a drain pan piped to a drain. However, unanticipated damage can be reduced or prevented by a leak detector or water shut-off device used in conjunction with a piped drain pan. These devices are available from some plumbing supply wholesalers and retailers, and detect and react to leakage in various ways:

- Sensors mounted in the drain pan that trigger an alarm or turn off the incoming water to the water heater when leakage is detected.
- Sensors mounted in the drain pan that turn off the water supply to the entire home when water is detected in the drain pan.
- Water supply shut-off devices that activate based on the water pressure differential between the cold water and hot water pipes connected to the water heater.

## INSULATION BLANKETS

Insulation blankets are available to the general public for external use on electric water heaters but are not necessary with this product. The purpose of an insulation blanket is to reduce the standby heat loss encountered with storage tank heaters. Your water heater meets or exceeds the National Appliance Energy Conservation Act standards with respect to insulation and standby loss requirements, making an insulation blanket unnecessary.

Should you choose to apply an insulation blanket to this heater, you should follow these instructions below. Failure to follow these instructions can result in fire, serious personal injury, or death.

- **Do not** cover the temperature and pressure relief (T & P) valve with an insulation blanket.
- **Do not** cover the instruction manual. Keep it on the side of the water heater or nearby for future reference.
- **Do** obtain new warning and instruction labels for placement on the blanket directly over the existing labels.

# INSTALLING THE NEW SOLAR WATER HEATER

### CAUTION

#### Property Damage Hazard

- Avoid water heater damage.
- Install thermal expansion tank if necessary.
- Do not apply heat to cold water inlet.
- Contact qualified installer or service agency.

## LOCAL CODES

The installation of solar water heater must be in accordance with these instructions and all applicable local codes and electric utility requirements. In the absence of local codes, install in accordance with the current edition of the National Electrical Code (NFPA-70).

## TEMPERATURE-PRESSURE RELIEF VALVE

### ⚠ WARNING

#### Explosion Hazard

- Temperature-pressure relief valve must comply with ANSI Z21.22, CSA 4.4 and ASME Code.
- Properly sized temperature-relief valve must be installed in opening provided.
- Can result in overheating and excessive tank pressure.
- Can cause serious injury or death.

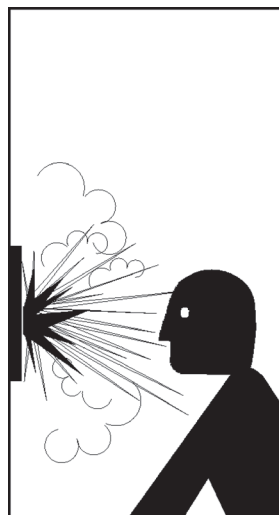

This heater is provided with a properly certified combination temperature - pressure relief valve by the manufacturer.

The valve is certified by a nationally recognized testing laboratory that maintains periodic inspection of production of listed equipment of materials as meeting the requirements for Relief Valves for Hot Water Supply Systems, ANSI Z21.22 • CSA 4.4, and the code requirements of ASME.

If replaced, the valve must meet the requirements of local codes, but not less than a combination temperature and pressure relief valve certified as indicated in the above paragraph.

The valve must be marked with a maximum set pressure not to exceed the marked hydrostatic working pressure of the water heater (150 psi = 1,034.21 kPa) and a discharge capacity not less than the water heater input rate as shown on the model rating plate (Electric heaters - watts x 3.412 equal BTU/hr rate).

**For safe operation of the water heater, the relief valve must not be removed from its designated opening nor plugged.**

The temperature-pressure relief valve must be installed directly into the fitting of the water heater designed for the relief valve. Position the valve downward and provide tubing so that any discharge will exit only within 6 inches (152.4 mm) above an adequate drain, or external to the building or structure. Be certain that no contact is made with any live electrical part. The discharge opening must not be blocked or reduced in size under any circumstances. Excessive length, over 30 feet (9.14 m), or use of more than four elbows can cause restriction and reduce the discharge capacity of the valve.

No valve or other obstruction is to be placed between the relief valve and the tank. Do not connect tubing directly to discharge drain unless a 6 inch air gap is provided. The relief valve must be allowed to discharge water in sufficient quantities, should circumstances demand, to prevent bodily injury, hazard to life, or property damage. If the discharge pipe is not connected to a drain or other suitable means, the water flow may cause property damage.

<b>CAUTION</b>
<b>Water Damage Hazard</b>
• Temperature-pressure relief valve discharge pipe must terminate at adequate drain.

The Temperature & Pressure Relief Valve:

- Must not be in contact with any electrical part.
- Must be connected to an adequate discharge line.
- Must be rated higher than the working pressure shown on the rating plate of the water heater

The Discharge Pipe:

- Must not be smaller than the pipe size of the relief valve or have any reducing coupling installed in the discharge line.
- Must not be capped, blocked, plugged or contain any valve between the relief valve and the end of the discharge line.
- Must terminate a maximum of six inches above a floor drain or external to the building. In cold climates, it is recommended

that the discharge line be terminated at an adequate drain inside the building.

- Must be capable of withstanding 250°F (121°C) without distortion.
- Must be installed to allow complete drainage of both the valve and discharge line.

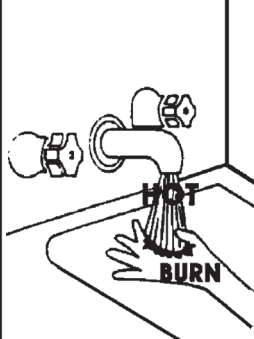
<b>⚠ DANGER</b>	Water temperature over 125°F (52°C) can cause severe burns instantly resulting in severe injury or death.
	Children, the elderly, and the physically or mentally disabled are at highest risk for scald injury.
	Feel water before bathing or showering.
	Temperature limiting valves are available.
	Read this instruction manual for safe temperature setting.

The temperature-pressure relief valve must be manually operated at least once a year. Caution should be taken to ensure that (1) no one is in front of or around the outlet of the temperature-pressure relief valve discharge line, and (2) the water manually discharged will not cause any bodily injury or property damage because the water may be extremely hot.

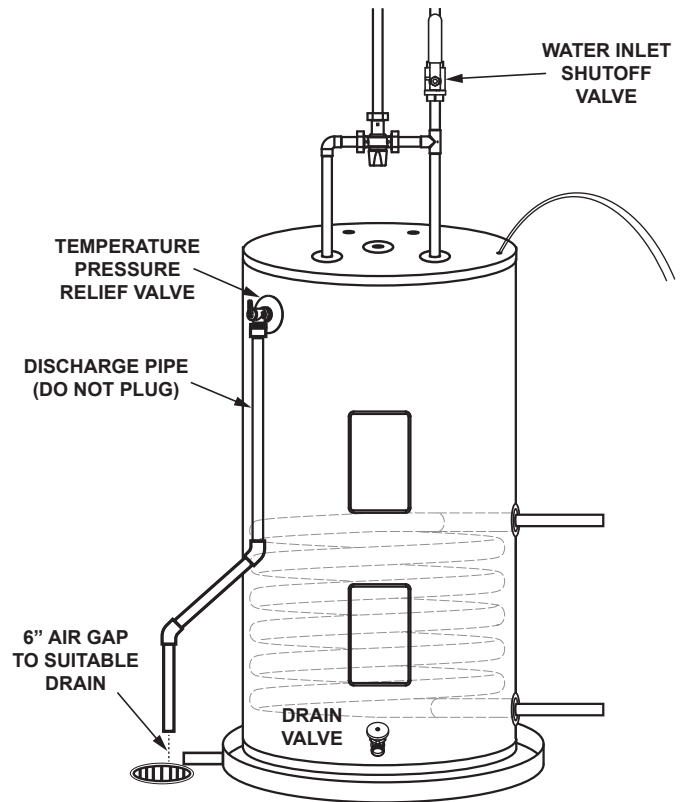

Figure 2.

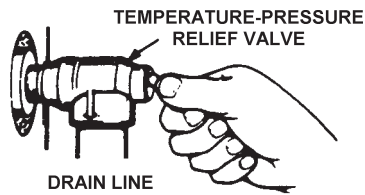

Figure 3.

**WARNING:** The temperature-pressure relief valve should be manually opened once a year. Caution should be taken to ensure that (1) no one is in front of or around the outlet of the temperature-pressure relief valve discharge line, and (2) the water manually discharged will not cause any bodily injury or property damage because the water may be extremely hot.

If after manually operating the valve, it fails to completely reset and continues to release water, immediately close the cold water inlet to the water heater, follow the draining instructions, and replace the temperature-pressure relief valve with a new one.

**WARNING:** If the temperature-pressure relief valve on the water heater weeps this may be due to thermal expansion. The water supply serving this solar water heater may have a check valve installed. Contact the water supplier or local plumbing contractor on how to control this situation. Do not plug the temperature-pressure relief valve.

### CLOSED SYSTEM/THERMAL EXPANSION

	<h2>⚠ WARNING</h2> <h3>Explosion Hazard</h3>
	<ul style="list-style-type: none"> <li>• Temperature-pressure relief valve must comply with ANSI Z21.22, CSA 4.4 and ASME Code.</li> <li>• Properly sized temperature-relief valve must be installed in opening provided.</li> <li>• Can result in overheating and excessive tank pressure.</li> <li>• Can cause serious injury or death.</li> </ul>

Most public water systems in North America are required to prevent water flowing from points of use (residences, businesses, etc.) back into the supply system in order to maintain water quality. To accomplish this, back flow preventers such as check valves, are installed in the water line going to each point of use. Typically the back flow preventer will be installed at the water meter or inside a building where the supply line enters the building. This device allows water to flow into the residence but does not allow it to flow back into the water supply. This creates what is known as a "Closed System". As water is heated by the water heater, the water in the system attempts to expand, but has nowhere to go resulting in an increase in pressure. This increase in pressure in the system may cause the temperature-pressure relief valve to open to relieve the pressure. Water will drip from the temperature and pressure relief valve. Premature tank failure will result if this condition is not corrected. To prevent this condition, a properly-sized thermal expansion tank should be installed in the cold

water supply to the water heater. Failure to install a properly sized expansion tank in a closed system will void the warranty on the water heater in the event of tank failure. It is important to follow the thermal expansion tank manufacturers' installation instructions and to adjust the expansion tank pressure to match the water supply pressure. Contact a plumbing service agency or your retail supplier regarding the installation of a thermal expansion tank.

### LOCATING THE SOLAR WATER HEATER

If you have a choice of where to install the solar water heater, these ideas may help you decide.

1. Put the solar water heater indoors as close as possible to where you use the most hot water. This water heater is not intended for outdoor installation.
2. It is handy to have a floor drain, tub or sink nearby. That will make it easy to drain water from the water heater. It is also a good place to end the drain line of the temperature-pressure relief (T & P) valve.
3. The solar water heater or the pipes and the connections may, in time, leak. Put the water heater in a place where a water leak will not damage anything.
4. You must not put the water heater in an area where it might freeze. You must turn off the electricity to the water heater before you drain it, to protect the heating elements.
5. Make sure that you are able to reach the drain valve and all access panels when the water heater is in place. This will make it easy to service the water heater.
6. The water heater must be level before you begin the piping.

<h2>CAUTION</h2> <h3>Property Damage Hazard</h3>
<ul style="list-style-type: none"> <li>• All water heaters eventually leak</li> <li>• Do not install without adequate drainage.</li> </ul>

**WATER HEATERS EVENTUALLY LEAK.** The installation of the water heater must be accomplished in such a manner that if the tank or any connections should leak, the flow of water will not cause damage to the area adjoining the water heater or to lower floors of the structure. When such locations can't be avoided, a suitable drain pan should be installed under the water heater. Such a pan should be no greater than 1-1/2 (45mm) inches deep, have a minimum length and width of at least two inches (51mm) greater than the water heater dimensions and must be piped to an adequate drain.

### WATER PIPING

<h2>⚠ DANGER</h2>	<p>Water temperature over 125°F (52°C) can cause severe burns instantly resulting in severe injury or death.</p> <p>Children, the elderly, and the physically or mentally disabled are at highest risk for scald injury.</p> <p>Feel water before bathing or showering.</p> <p>Temperature limiting valves are available.</p> <p>Read this instruction manual for safe temperature setting.</p>

### HOTTER WATER CAN SCALD:

Water heaters are intended to produce hot water. Water heated to a temperature which will satisfy space heating, clothes washing, dish washing, cleaning and other sanitizing needs can scald and permanently injure you upon contact. Some people are more likely to be permanently injured by hot water than others. These include the elderly, children, the infirm, or physically/mentally disabled. If anyone using hot water in your home fits into one of these groups or if there is a local code or state law requiring a certain temperature water at the hot water tap, then you must take special precautions. In addition to using the lowest possible temperature setting that satisfies your hot water needs, a means such as a mixing valve should be used at the hot water taps used by these people or at the water heater. Valves for reducing point of use temperature by mixing cold and hot water are also available.

Consult a Qualified Installer or Service Agency. Follow manufacturer's instructions for installation of the valves. Before changing the factory setting on the thermostat, read the "Temperature Regulation" section in this manual.

**WARNING:** Toxic chemicals such as used for treatment of boilers or non-potable water heating appliances shall never be introduced into a potable water space heating system.

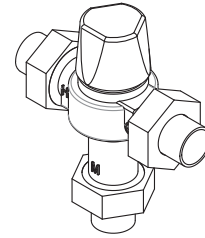
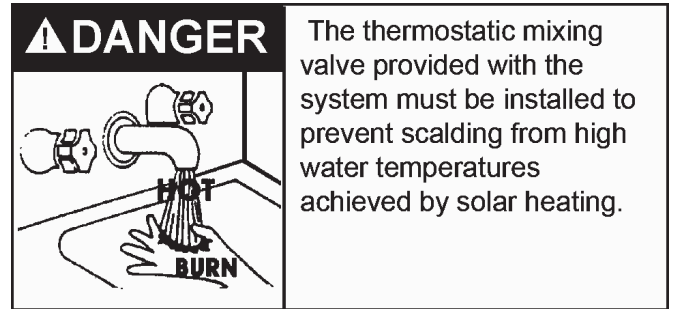

Figure 4.

The solar water heater will work better if you keep the hot water runs short. You will also get hot water faster and with less heat loss.

The illustration shows the correct valves and fittings that you will need to install the solar water heater. Threaded (3/4") water connections are supplied through the tank top.

<b>⚠ WARNING</b>
<b>Toxic Chemical Hazard</b>
• Do not connect to non-potable water system.

This water heater shall not be connected to any heating systems or component(s) used with a non-potable water heating appliance.

Use properly sized water heaters for spa or hot tub use.

Toxic chemicals, such as those used for boiler treatment shall not be introduced into this system.

As water is heated, it expands (thermal expansion). In a closed system, the volume of water will grow. As the volume of water grows, there will be a corresponding increase in water pressure due to thermal expansion. Thermal expansion can cause premature tank failure (leakage). This type of failure is not covered under the limited warranty. Thermal expansion can also cause intermittent temperature-pressure relief valve operation: water discharged from the valve due to excessive pressure build up. The temperature-pressure relief valve is not intended for the constant relief of thermal expansion. This condition is not covered under the limited warranty

A properly-sized thermal expansion tank should be installed on all closed systems to control the harmful effects of thermal expansion. Thermal expansion tanks are available through a local plumbing contractor. Contact the local plumbing inspector, water supplier and/or service agency for assistance in controlling these situations. This water heater is design certified to be used with a potable water system. When connecting water piping with solder joints use only lead free solder.

**WARNING:** This solar water heater shall not be connected to any heating systems or component(s) previously used with a non-potable water heating appliance.

If this solar water heater is also used for space heating applications, all piping and components connected to the solar water heater shall be suitable for use with potable water.

This water heater has been design certified as a solar water heater complying with Standards for Safety - UL 174/CAN/CSA C-22.2. The particular application of this water heater described (above paragraph) may be subject to review and approval by local code officials.

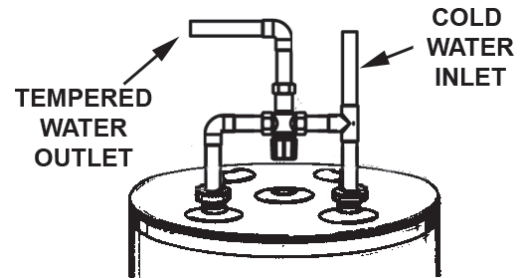

Figure 5.

1. Purchase the fittings that you need to connect the pipes. Remember that you have to connect both the hot and cold water pipes.
2. Apply a light covering of pipe joint compound to each outside thread before making connection.
3. Connect the cold water supply pipe to the cold water inlet of your solar water heater as follows:
  - a. Look at the top cover of the solar water heater. The hot and cold connections are marked there.
  - b. A non-metallic dip tube is supplied to carry cold water from the tank top to the bottom. Be sure that it is in the cold water inlet.
  - c. If using copper tubing, solder tubing to an adapter BEFORE you attach the adapter to the cold water inlet. DO NOT solder the cold water supply pipe directly to the cold water inlet connection. It might harm the dip tube.
  - d. The cold water supply line must have a shut-off valve and union.
4. Use a union to connect the hot water supply pipe to the solar

water heater's hot water outlet.

**CAUTION:** Operating an empty or partially filled solar water heater will result in damage to the tank.

If a solar water heater is installed in a closed water system; such as one having a back flow preventer, check valve or water meter with check valve in the cold water supply line, means shall be provided to control thermal expansion. Contact the water supplier or local plumbing contractor on how to control this situation.

**INSTALLATION IN RESIDENTIAL GARAGES:** The solar water heater must be located and/or protected so it is not subject to physical damage by a moving vehicle.

**FILLING THE SOLAR WATER HEATER WITH WATER**

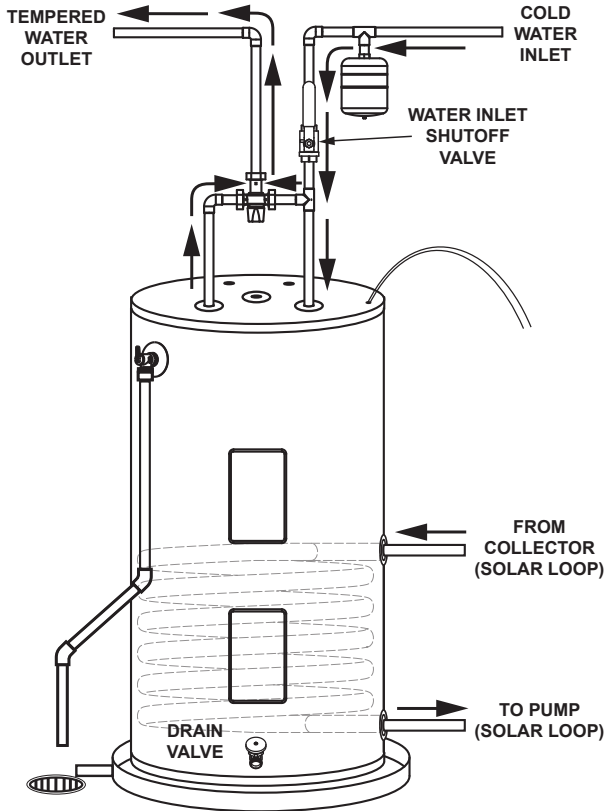

Figure 6.

1. Close the solar water heater drain valve. The drain valve is on the lower front of the solar water heater.
2. Open the cold water supply to the solar water heater. NOTE: THIS VALVE MUST BE LEFT OPEN WHEN THE SOLAR WATER HEATER IS IN USE.
3. Fill the solar water heater until a constant flow of water runs out an opened hot water faucet. This will let out air in the solar water heater and the piping. Close the faucet after all air has been purged and the water comes out with constant flow. You must not turn the electricity on until the solar water heater is full of water. IF ANY AIR IS LEFT IN THE TOP OF THE SOLAR WATER HEATER THE HEATING ELEMENT WILL BURN OUT IMMEDIATELY.
4. Check all the new water piping for leaks. Fix as needed.

5. Never alter or modify the certified construction of the water heater system or its components, or bypass any safety features. Doing so voids all warranties.

**T&P VALVE and PIPE INSULATION (Selected Models)**

When a supplemental heat source such as a solar storage tank is connected to the water heater, a remote temperature control device should be installed in the water piping to limit water temperatures. The temperature setting of this control should not exceed that of the water heater thermostat setting. Failure to adjust both thermostats can cause loss of proper temperature control, and could potentially produce water temperature in excess of 180°F.

Remove insulation for T&P Valve and pipe connections from carton.

Fit pipe insulation over the incoming cold water line and the hot water line. Make sure that the insulation is against the top cover of the heater.

Fit T&P Valve insulation over valve. Make sure that the insulation does not interfere with the lever or outlet of the T&P valve. Secure all insulation using tape.

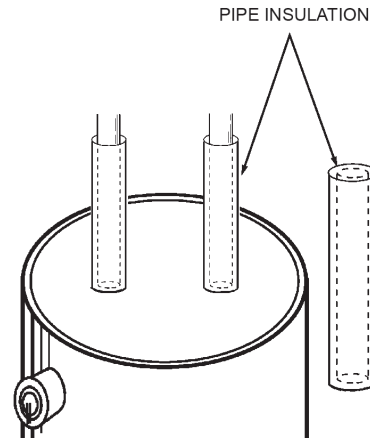

Figure 7.

**WIRING OF ELEMENT**

CAUTION

Improper installation and use may result in property damage.

- Fill tank with water before operation.

Never use water heater unless it is completely full of water. To prevent damage to the tank and heating element, the tank must be filled with water. Water must flow from the hot water faucet before turning on power.

You must provide all wiring of the proper size outside of the water heater. You must obey local codes and electric company requirements when you install this wiring.

If you are not familiar with electric codes and practices, or if you have any doubt, even the slightest doubt, in your ability to connect



the wiring to this water heater, obtain the service of a competent electrician. Contact a local electrical contractor and/or the local electric utility.

⚠ **WARNING**

**Fire Hazard / Electric Shock Hazard**



- Do not use this water heater with any voltage other than shown on the model rating plate.
- Failure to use the correct voltage shown on the model rating plate could result in death, serious bodily injury, or property damage.

**WATER HEATERS EQUIPPED FOR ONE VOLTAGE ONLY:** This water heater is equipped for one type voltage only. Check the rating plate near the bottom access panel for the correct voltage. **DO NOT** use this water heater with any voltage other than the one shown on the model rating plate. Failure to use the correct voltage can cause problems which can result in **DEATH, SERIOUS BODILY INJURY, OR PROPERTY DAMAGE**. If you have any questions or doubts consult your electric company.

If wiring from your fuse box or circuit breaker box was aluminum for your old water heater, replace it with copper wire. If you wish to reuse the existing aluminum wire, have the connection at the water heater made by a competent electrician. Contact a local electrical contractor and/or the local electric utility.

1. Provide a way to easily shut off the electric power when working on the water heater. This could be with a circuit breaker or fuse block in the entrance box or a separate disconnect switch.
2. Install and connect a circuit directly from the main fuse or circuit breaker box. This circuit must be the right size and have its own fuse or circuit breaker.
3. If metal conduit is used for the grounding conductor:
  - A. The grounding electrode conductor shall be of copper, aluminum, or copperclad aluminum. The material shall be of one continuous length without a splice or joint.
  - B. Rigid metal conduit, intermediate metal conduit, or electrical, metallic tubing may be used for the grounding means if conduit or tubing is terminated in fittings approved for grounding.
  - C. Flexible metal conduit or flexible metallic tubing shall be permitted for grounding if all the following conditions are met:
    - The length in any ground return path does not exceed 6 feet (1.83 m).
    - The circuit conductors contained therein are protected by overcurrent devices rated at 20 amperes or less.
    - The conduit or tubing is terminated in fittings approved for grounding.
    - For complete grounding details and all allowable exceptions, refer to the current edition of the Nation Electrical Code NFPA 70.
4. A standard 1/2" (1.27 cm) conduit opening has been made in the water heater junction box for the conduit connections.
5. Use wire nuts and connect the power supply wiring to the wires inside the water heater's junction box.

6. The water heater must be electrically "grounded" by the installer. A green ground screw has been provided on the water heater's junction box. Connect ground wire to this location.
7. Replace the wiring junction cover using the screw provided.

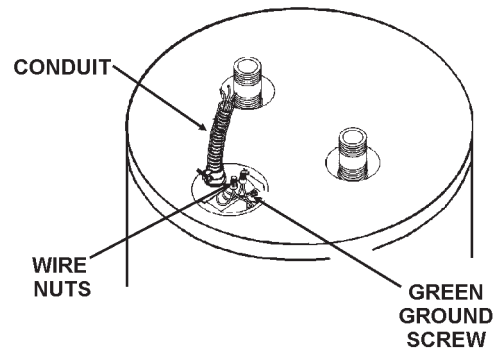

Figure 8.

**CAUTION:** If wiring from the fuse box or circuit breaker box was aluminum for the old tank, replace it with copper wire. If you wish to reuse the existing aluminum wire, have the connection at the solar water heater made by a competent electrician. Contact your local utility to arrange for a professional electrician.

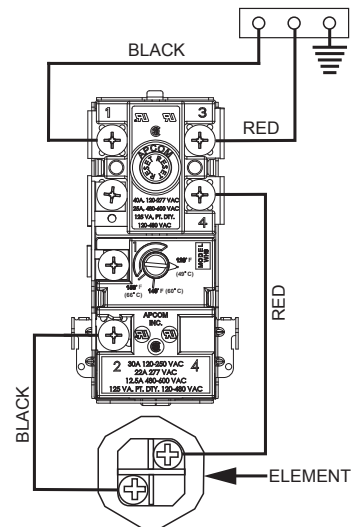

Figure 9.

## THERMOSTAT

Each thermostat is factory preset at 120°F (49°C) to reduce the risk of scald injury. This setting has proven by experience to be most satisfactory from the standpoint of operational costs and household needs.

Solar water heaters installed in Florida require the thermostat(s) to be set at 125°F (52°C). If you wish to adjust the settings, see the "Temperature Adjustment" section of this installation manual.

## TANK SENSOR

The surface mount tank sensor should be attached to the sensor stud behind the lower door by placing the hole in the sensor over the stud provided and securing in place with a nut. The end of the tank sensor shall be connected to the red wires in the opening with wire nuts (with no regard for polarity). The other ends of the red temperature sensor extension extend from the top of the tank and shall be connected to the controller in the tank sensor position.

# OPERATION

## TEMPERATURE REGULATION

### ⚠ DANGER

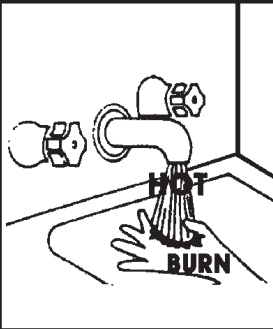

Untempered hot water can cause severe burns instantly resulting in severe injury or death.

Children, elderly, and the physically or mentally disabled are at highest risk for scald injury.

Feel water before bathing or showering.

Temperature limiting valves are available.

**HOTTER WATER CAN SCALD:** Solar water heaters are intended to produce hot water. Water heated to a temperature which will satisfy clothes washing, dish washing, and other sanitizing needs can cause scalds resulting in serious personal injury and/or death. Some people are more likely to be permanently injured by hot water than others. These include the elderly, children, the infirmed, or physically handicapped. If anyone using hot water in your home fits into one of these groups or if there is a local code or state law requiring a certain temperature water at the hot water tap, then you must take special precautions. In addition to using the lowest possible temperature setting that satisfies your hot water needs, some type of tempering device, such as a mixing valve should be used at the hot water taps used by these people or at the solar water heater. Mixing valves are available at plumbing supply or hardware stores. Follow manufacturers instructions for installation of the valves. Before changing the factory setting of the thermostat, read the Temperature Adjustment section.

**KEEPING THE THERMOSTAT SETTING AT 120°F (49°C) WILL REDUCE THE RISK OF SCALDS.** Never allow small children to use a hot water tap, or to draw their own bath water. Never leave a child or handicapped person unattended in a bathtub or shower.

## TEMPERATURE SETTINGS

NOTE: Residential solar water heaters will not supply sanitizing hot water for dishwashers.

The thermostat is factory set at its lowest position which approximates 120°F (49°C) (Hot) and is adjustable if a different water temperature is desired. Read all warnings in this manual and on the solar water heater before proceeding.

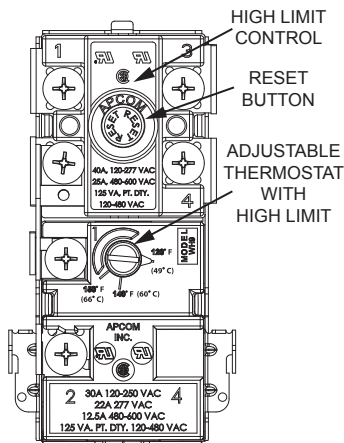

Water Temperature °F(°C)	Time for 1st Degree Burn (Less Severe Burns)	Time for Permanent Burns 2nd & 3rd Degree (Most Severe Burns)
110 (43)	(normal shower temp.)	
116 (47)	(pain threshold)	
116 (47)	35 minutes	45 minutes
122 (50)	1 minute	5 minutes
131 (55)	5 seconds	25 seconds
140 (60)	2 seconds	5 seconds
149 (65)	1 second	2 seconds
154 (68)	Instantaneous	1 seconds

(U.S. Government Memorandum, C.P.S.C., Peter L. Armstrong, 9/15/1978)

Figure 10.

## TEMPERATURE ADJUSTMENT

To adjust the temperature setting:

1. Turn off the heater electrical supply. Do not attempt to adjust thermostat with power on.



### ⚠ WARNING

- Before removing any access panels or servicing the water heater, make sure the electrical supply to the water heater is turned "OFF."
- Failure to do this could result in death, serious bodily injury, or property damage.

2. Remove the thermostat access panel(s) and fold up insulation to expose the thermostats. Do not remove the plastic personnel protectors covering the thermostats.
3. Using a flat tip screwdriver, rotate the adjustment knob to the desired temperature setting.
4. Replace the insulation and access panels and turn on heater electrical supply.

A non-adjustable high temperature limit control operates before steam temperatures are reached. The high limit is in the same area as the upper thermostat and must be reset manually when it operates. BECAUSE THE HIGH LIMIT OPERATES ONLY WHEN ABNORMALLY HIGH WATER TEMPERATURES ARE PRESENT, IT IS IMPORTANT THAT A QUALIFIED SERVICE AGENT BE CONTACTED TO DETERMINE THE REASON FOR OPERATION BEFORE RESETTING.

# FOR YOUR INFORMATION

## THERMAL EXPANSION

### CAUTION

#### Property Damage Hazard

- Avoid water heater damage.
- Install thermal expansion tank or device if necessary.
- Contact qualified installer or service agency.

As water is heated, it expands (thermal expansion). In a closed system, the volume of water will grow. As the volume of water grows, there will be a corresponding increase in water pressure due to thermal expansion. Thermal expansion can cause premature tank failure (leakage). This type of failure is not covered under the limited warranty. Thermal expansion can also cause intermittent temperature-pressure relief valve operation: water discharged from the valve due to excessive pressure build up. The temperature-pressure relief valve is not intended for the constant relief of thermal expansion. This condition is not covered under the limited warranty.

A properly-sized thermal expansion tank should be installed on all closed systems to control the harmful effects of thermal expansion. Thermal expansion tanks are available through a local plumbing contractor. Contact the local plumbing inspector, water supplier and/or service agency for assistance in controlling these situations.

## STRANGE SOUNDS

Possible noises due to expansion and contraction of some metal parts during periods of heat-up and cool-down do not necessarily represent harmful or dangerous conditions.

## WATER ODOR

In each water heater there is installed at least one anode rod (see parts sections) for corrosion protection of the tank. Certain water conditions will cause a reaction between this rod and the water. The most common complaint associated with the anode rod is one of a "rotten egg smell" in the hot water. This odor is derived from hydrogen sulfide gas dissolved in the water. The smell is the result of four factors which must all be present for the odor to develop:

- A. A concentration of sulfate in the supply water.
- B. Little or no dissolved oxygen in the water.
- C. A sulfate reducing bacteria which has accumulated within the water heater (this harmless bacteria is nontoxic to humans).
- D. An excess of active hydrogen in the tank. This is caused by the corrosion protective action of the anode.

Smelly water may be eliminated or reduced in some water heater models by replacing the anode(s) with one of less active material, and then chlorinating the water heater tank and all hot water lines. Contact the local water heater supplier or service agency for further information concerning an Anode Replacement Kit and this chlorination treatment. If the smelly water persists after the anode replacement and chlorination treatment, we can only suggest that chlorination or aeration of the water supply be considered to eliminate the water problem.

**Do not remove the anode leaving the tank unprotected. By doing so, all warranty on the water heater tank is voided.**

## "AIR" IN HOT WATER FAUCETS

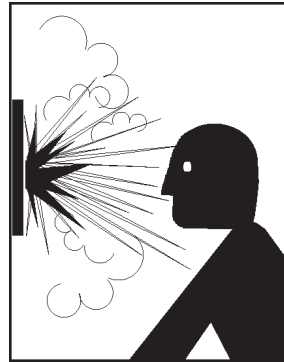

### WARNING

#### Explosion Hazard

- Flammable hydrogen gases may be present.
- Keep all ignition sources away from faucet when turning on hot water.

**HYDROGEN GAS:** Hydrogen gas can be produced in a hot water system that has not been used for a long period of time (generally two weeks or more). Hydrogen gas is extremely flammable and explosive. To prevent the possibility of injury under these conditions, we recommend the hot water faucet, located farthest away, be opened for several minutes before any electrical appliances which are connected to the hot water system are used (such as a dishwasher or washing machine). If hydrogen gas is present, there will probably be an unusual sound similar to air escaping through the pipe as the hot water faucet is opened. There must be no smoking or open flame near the faucet at the time it is open.

## HIGH WATER TEMPERATURE SHUT OFF SYSTEM

A non-adjustable high temperature limit control operates before steam temperatures are reached. The high limit is in the same area as the upper thermostat and must be reset manually when it operates. BECAUSE THE HIGH LIMIT OPERATES ONLY WHEN ABNORMALLY HIGH WATER TEMPERATURES ARE PRESENT, IT IS IMPORTANT THAT A QUALIFIED SERVICE AGENT BE CONTACTED TO DETERMINE THE REASON FOR OPERATION BEFORE RESETTING.



### WARNING

- Before removing any access panels or servicing the water heater, make sure the electrical supply to the water heater is turned "OFF."
- Failure to do this could result in death, serious bodily injury, or property damage.

- Turn off the heater electrical supply. Do not attempt to reset thermostat with power on.
- Remove the screw securing the outer door and remove door.
- Fold up the insulation to expose the reset button.
- Reset the high limit by pushing in the red button marked "RESET".

# MAINTENANCE

## DRAINING & FLUSHING

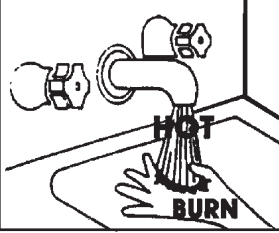

**⚠ DANGER**

- Burn hazard
- Hot water discharge.
- Keep hands clear of drain valve discharge.

The water heater should be drained if being shut down during freezing temperatures. It is recommended that the tank be drained, and flushed every 6 months to remove sediment which may buildup during operation. To drain the tank perform the following steps:

1. Disconnect the electrical power to the water heater.
2. Open a hot water faucet until water is no longer hot.
3. Close the cold water inlet valve and open a hot water faucet.
4. Connect a hose to the drain valve and terminate it to an adequate drain.
5. Open the water heater drain valve and the nearest hot water faucet. Allow all the water to drain from the tank. Flush the tank with water as needed to remove sediment.
6. Close the drain valve and completely refill the water heater tank.
7. Reconnect electrical power to the water heater. If the water heater is going to be shut down for an extended period, the drain valve should be left open.

## ELEMENT

In some water areas, scale or mineral deposits will build up on heating elements. This build up will cause a rumbling noise. Follow the element replacement directions to remove the elements from the tank. Soaking in vinegar and scraping will remove the mineral deposit. Be careful not to bend the element.

## HEATING ELEMENT REPLACEMENT

Replacement heating elements must be of the same style and voltage/wattage rating as the ones presently in the water heater. This information can be found on the flange or terminal block of the element or on the water heater data plate.

1. Disconnect the electrical power to the water heater.
2. Drain the water heater as directed in the "Draining and Flushing" section.
3. Remove the access cover(s). Fold up the insulation from the heater element(s). Remove the plastic thermostat cover from the thermostat(s) making sure to disengage the attachment point from the thermostat.
4. Disconnect the electrical wires from the heating element(s) by loosening the screws (Figure 11). Remove the screw-in element(s) by turning the element(s) counterclockwise with a 1-1/2 inch socket wrench. Remove the existing gasket(s).

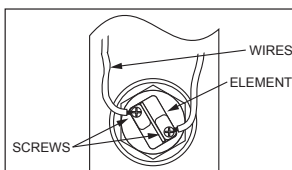
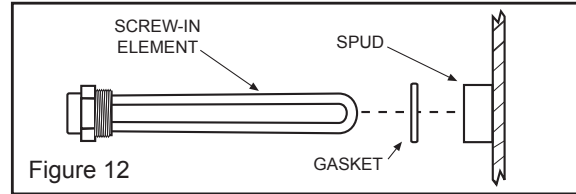

Figure 11

5. Clean the area where the gasket(s) fits to the tank. If you are replacing the bottom element, remove the accumulated sediment on the bottom of the tank.

6. Make sure the replacement element(s) has the correct voltage and wattage rating by matching it to the rating plate on the water heater. Position the new gasket(s) on the element and insert it into the water heater tank (Figure 12). Tighten the element by turning it clockwise until secure.



7. Close the drain valve. Open the nearest hot water faucet and allow the tank to fill completely with water. To purge the lines of any excess air and sediment, keep the hot water faucet open for 3 minutes after a constant flow of water is obtained.
8. Check for leaks around the element(s).
9. Reconnect the electrical wires to the element and securely tighten the screws. Replace the plastic thermostat cover making sure the attachment points are engaged on the thermostat.
10. Replace the access cover(s).
11. Make certain the tank is filled with water. Applying electric current to heater elements not submerged in water will destroy them.
12. Reconnect electrical power to the water heater.

## THERMOSTAT REMOVAL / REPLACEMENT



**⚠ WARNING**

- Before removing any access panels or servicing the water heater, make sure the electrical supply to the water heater is turned "OFF."
- Failure to do this could result in death, serious bodily injury, or property damage.

1. Turn "OFF" the electric power supply to the water heater.
2. Remove the outer door. Remove or fold up the insulation pad.
3. **Models with Upper or Lower Thermostat with High Limit:** Lift out the tab as shown below to unclip the terminal cover from the thermostat. The terminal cover can now be removed from the thermostat.

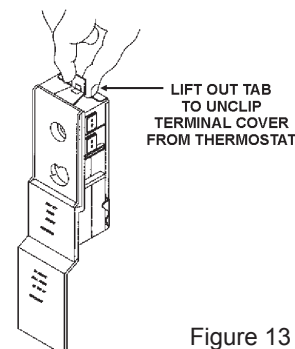

4. Disconnect wires from thermostat and slide out of the bracket.
5. Remove the thermostat from behind the thermostat bracket.
6. Place the new lower thermostat in the bracket making sure

it fits firmly against the tank.

7. Attach the wires to the new thermostat.

**NOTE: Some of the terminals may require straight-in wiring through an eye-opening. If wires are now looped, recut and strip wire 3/8" (9.525 mm) to a straight length and insert.**

8. Put plastic terminal cover back in place.
9. Replace the insulation to cover the thermostat.
10. Replace outer door then turn the electric power on.

## ANODE ROD INSPECTION

### CAUTION

#### Property Damage Hazard

- Avoid water heater damage.
- Inspection and replacement of anode rod required.

Each water heater contains at least one anode rod, which will slowly deplete (due to electrolysis) prolonging the life of the water heater by protecting the glass-lined tank from corrosion. Adverse water quality, hotter water temperatures, high hot water usage, and water softening methods can increase the rate of anode rod depletion. Once the anode rod is depleted, the tank will start to corrode, eventually developing a leak.

Certain water conditions will cause a reaction between the anode rod and the water. The most common complaint associated with the anode rod is a "rotten egg smell" produced from the presence of hydrogen sulfide gas dissolved in the water. **IMPORTANT:** Do not remove this rod permanently as it will void any warranties. A special anode rod may be available if water odor or discoloration occurs. **NOTE:** This rod may reduce but not eliminate water odor problems. The water supply system may require special filtration equipment from a water conditioning company to successfully eliminate all water odor problems.

Artificially softened water is exceedingly corrosive because the process substitutes sodium ions for magnesium and calcium ions. The use of a water softener may decrease the life of the water heater tank.

The anode rod should be removed from the water heater tank every 3 years for inspection. **NOTE:** artificially softened water requires the anode rod to be inspected annually.

The following are typical (but not all) signs of a depleted anode rod:

- The majority of the rods diameter is less than 3/8" (9.5 mm).
- Significant sections of the support wire (approx. 1/3 or more of the anode rod's length) are visible.

If the anode rod show signs of either or both it should be replaced. **NOTE:** Whether re-installing or replacing the anode rod, check for any leaks and immediately correct if found.

In replacing the anode:

1. Turn off power to the water heater.
2. Shut off the water supply and open a nearby hot water faucet to depressurize the water tank.
3. Drain approximately 5 gallons (19 L) of water from tank. (Refer to "Draining and Flushing" for proper procedures). Close drain valve.
4. Remove old anode rod.
5. Use Teflon® tape or approved pipe sealant on threads and install new anode rod.
6. Turn on water supply and open a nearby hot water faucet to purge air from water system. Check for any leaks and immediately correct any if found.
7. Restart the water heater as directed in this manual. See the Repair Parts

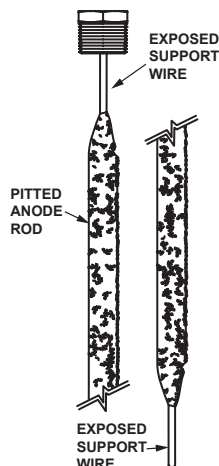

Figure 14.

Illustration for anode rod location.

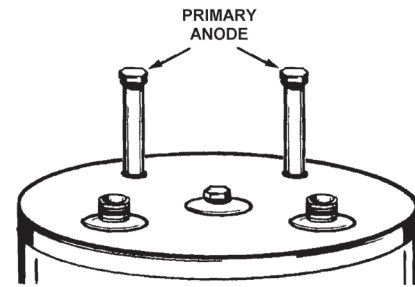

Figure 15.

## TEMPERATURE-PRESSURE RELIEF VALVE OPERATION

	<ul style="list-style-type: none"><li>• Burn hazard</li><li>• Hot water discharge.</li><li>• Keep clear of relief valve discharge outlet.</li></ul>
--	---

The temperature-pressure relief valve must be manually operated at least once a year.

When checking the temperature-pressure relief valve operation, make sure that (1) no one is in front of or around the outlet of the temperature-pressure relief valve discharge line, and (2) that the water discharge will not cause any property damage, as the water may be extremely hot, see Figure 16.

### TEMPERATURE-PRESSURE RELIEF VALVE

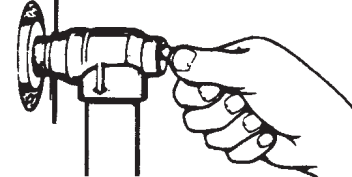

### DISCHARGE PIPE

Figure 16.

If after manually operating the valve, it fails to completely reset and continues to release water, immediately close the cold water inlet to the water heater, follow the draining instructions, and replace the temperature-pressure relief valve with a new one.

If the temperature-pressure relief valve on the water heater weeps or discharges periodically, this may be due to thermal expansion. You may have a check valve installed in the water line or a water meter with a check valve. Consult your local water supplier or service agency for further information. Do not plug or remove the temperature-pressure relief valve.

## WATER HEATER SOUNDS

1. The solar water heater is equipped with an immersion heating element for fastest recovery. If the solar water heater occasionally makes noises this is not a defect or a safety hazard.
2. Lime or scale has accumulated on the heating element causing a hissing sound. Element scale removal can be accomplished by using vinegar or by scraping.

# REPAIR PARTS

## REPAIR PARTS SCHEDULE

### ORDERING REPAIR PARTS

The following parts may be ordered through the store you purchased the solar water heater from, or direct from the factory listed on the model & rating plate located on the lower front of the solar water heater. Selling prices will be furnished on request or parts will be shipped at prevailing prices and you will be billed accordingly. When ordering repair parts always give the following information: (1) Part description, (2) Model serial number, (3) Element wattage, (4) Voltage, (5) Part number.

ITEM	PART DESCRIPTION	SERVICE PART #
1	Primary Anode	9003892005
2	2" NPT Plug	195197-001
3	Primary Dip Tube	9002549005
4	Element w/Gasket	9003950115
5	Thermostat Bracket	9003898215
6	Thermostat w/High Limit	9007623015
7	Terminal Cover	9003914015
8	Access Panel	9003900005
9	Sensor Mounting Plug	9007309005
10	Plastisert Nipple	9003976015
11	T&P Valve	9000728015
12	Drain Valve	9003906015

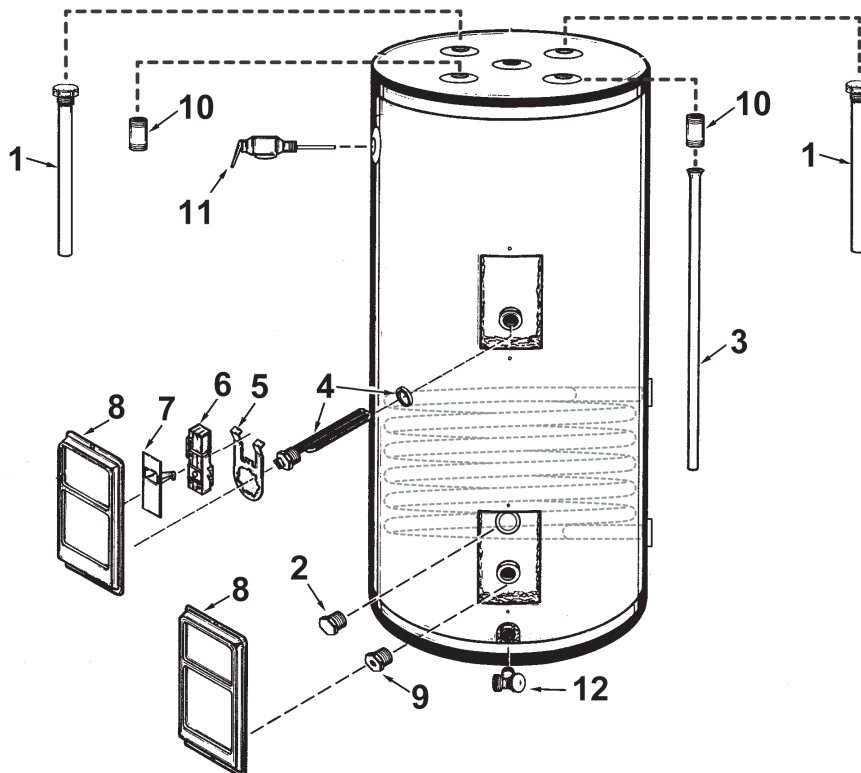

### RATING PLATE

A rating plate identifying the solar water heater will be found above the drain valve. When referring to the solar water heater, always have the information listed on the rating plate readily available.

Fill in that information here:

MODEL NO. \_\_\_\_\_  
 SERIAL NO. \_\_\_\_\_  
 INSTALLATION DATE: \_\_\_\_\_



# NOTES

# NOTES

# NOTES

