



DRAPER[®]

STORMFORCE

230V 210mm
**COMPOUND MITRE
SAW**

21307



These instructions accompanying the product are the original instructions. This document is part of the product, keep it for the life of the product passing it on to any subsequent holder of the product. Read all these instructions before assembling, operating or maintaining this product.

This manual has been compiled by Draper Tools describing the purpose for which the product has been designed, and contains all the necessary information to ensure its correct and safe use. By following all the general safety instructions contained in this manual, it will ensure both product and operator safety, together with longer life of the product itself.

All photographs and drawings in this manual are supplied by Draper Tools to help illustrate the operation of the product.

Whilst every effort has been made to ensure the accuracy of information contained in this manual, the Draper Tools policy of continuous improvement determines the right to make modifications without prior warning.

1. TITLE PAGE

1.1 INTRODUCTION:

USER MANUAL FOR: 230V 210mm Compound Mitre Saw

Stock No: 21307

Part No: MS210C

1.2 REVISIONS:

Date first published January 2019.

Date of first revision June 2020.

As our user manuals are continually updated, users should make sure that they use the very latest version.

Downloads are available from: <http://drapertools.com/manuals>

Draper Tools Limited
Hursley Road
Chandler's Ford
Eastleigh
Hampshire
SO53 1YF
UK

Website: drapertools.com

Product Help Line: +44 (0) 23 8049 4344

General Fax: +44 (0) 23 8026 0784

1.3 UNDERSTANDING THIS MANUALS SAFETY CONTENT:

WARNING! – Information that draws attention to the risk of injury or death.

CAUTION! – Information that draws attention to the risk of damage to the product or surroundings.

1.4 COPYRIGHT © NOTICE:

Copyright © Draper Tools Limited.

Permission is granted to reproduce this publication for personal and educational use only. Commercial copying, redistribution, hiring or lending is prohibited.

No part of this publication may be stored in a retrieval system or transmitted in any other form or means without written permission from Draper Tools Limited.

In all cases this copyright notice must remain intact.

2. CONTENTS

1	TITLE PAGE	
1.1	INTRODUCTION	2
1.2	REVISION HISTORY	2
1.3	UNDERSTANDING THIS MANUAL	2
1.4	COPYRIGHT NOTICE.....	2
2	CONTENTS	
2.1	CONTENTS.....	3
3	WARRANTY	
3.1	WARRANTY.....	5
4	INTRODUCTION	
4.1	SCOPE	6
4.2	SPECIFICATION	6
4.3	HANDLING AND STORAGE	6
5	HEALTH AND SAFETY INFORMATION	
5.1	GENERAL SAFETY INSTRUCTIONS FOR POWER TOOL USE	7
5.2	SAFETY INSTRUCTIONS FOR MITRE SAWS	8
5.3	ADDITIONAL SAFETY INSTRUCTIONS FOR CIRCULAR SAW BLADES	10
5.4	RESIDUAL RISK	10
5.5	CONNECTION TO THE POWER SUPPLY.....	10
6	TECHNICAL DESCRIPTION	
6.1	IDENTIFICATION	11
7	UNPACKING AND CHECKING	
7.1	PACKAGING	12
7.2	WHAT'S IN THE BOX.....	12
8	PREPARING THE COMPOUND MITRE SAW	
8.1	BENCH MOUNTING	13
8.2	WORKPIECE VICE	13
8.3	SAW HEAD LOCKING PIN	13
8.4	MITRE LOCKING ASSEMBLY	14
8.5	DUST EXTRACTION	14
8.6	DEPTH OF CUT STOP	14
8.7	BEVEL ADJUSTMENT.....	15
8.8	CHECKING THE TABLE TO BLADE ALIGNMENT.....	15
8.9	CHECKING THE FENCE TO BLADE ALIGNMENT.....	16
8.10	TABLE INSERT REPLACEMENT	16
8.11	BLADE REPLACEMENT.....	16
9	BASIC SAW OPERATIONS	
9.1	STARTING THE COMPOUND MITRE SAW.....	17
9.2	BODY AND HAND POSITION.....	17
9.3	MITRE CUT.....	17
9.4	BEVEL CUT.....	17
9.5	COMPOUND CUT	17
9.6	CUTTING CURVED OR WARPED MATERIAL.....	18
9.7	WORKPIECE SUPPORT.....	18

– Continued overleaf.

2. CONTENTS *(continued)*

10 MAINTENANCE AND TROUBLESHOOTING	
10.1 BLADE GUARD.....	19
10.2 SAWDUST.....	19
10.3 RECOMMENDED ACCESSORIES.....	19
10.4 PROHIBITED ACCESSORIES.....	19
10.5 LUBRICATION.....	19
10.6 CLEANING.....	19
10.7 TROUBLESHOOTING GUIDE.....	20
11 OPTIONAL ACCESSORIES	
11.1 OPTIONAL ACCESSORIES.....	21
12 DISPOSAL	
12.1 DISPOSAL.....	22
13 EXPLANATION OF SYMBOLS	
13.1 EXPLANATION OF SYMBOLS.....	23
DECLARATION OF CONFORMITY	ENCLOSED

3. WARRANTY

3.1 WARRANTY

Draper tools have been carefully tested and inspected before shipment and are guaranteed to be free from defective materials and workmanship.

Should the tool develop a fault, please return the complete tool to your nearest distributor or contact

Draper Tools Limited, Chandler's Ford, Eastleigh, Hampshire, SO53 1YF. England.

Telephone Sales Desk: (023) 8049 4333 or Product Help Line (023) 8049 4344.

A proof of purchase **must** be provided with the tool.

If upon inspection it is found that the fault occurring is due to defective materials or workmanship, repairs will be carried out free of charge. This warranty period covering labour is 12 months from the date of purchase except where tools are hired out when the warranty period is 90 days from the date of purchase. The warranty is extended to 24 months for parts only. This warranty does not apply to any consumable parts, any type of battery or normal wear and tear, nor does it cover any damage caused by misuse, careless or unsafe handling, alterations, accidents, or repairs attempted or made by any personnel other than the authorised Draper warranty repair agent.

Note: If the tool is found not to be within the terms of warranty, repairs and carriage charges will be quoted and made accordingly.

This warranty applies in lieu of any other warranty expressed or implied and variations of its terms are not authorised.

Your Draper warranty is not effective unless you can produce upon request a dated receipt or invoice to verify your proof of purchase within the warranty period.

Please note that this warranty is an additional benefit and does not affect your statutory rights.

Draper Tools Limited.

4. INTRODUCTION

4.1 SCOPE

This machine is designed for making angled mitre and bevel cuts to wood, for example picture frames and door frames.

This product is intended for domestic and infrequent light trade use only. Any application other than that it was intended for, is considered misuse.

4.2 SPECIFICATION

Stock No.	21307
Part No.	MS210C
Motor:	
Rated voltage	230V~
Rated frequency.....	50Hz
Rated input	1100W
Revolutions per minute (no load)	5500r/min
Blade diameter	210mm
Blade thickness	2.4mm
Bore diameter.....	30mm
Mitre table angles	0 – 45°
Bevel cut.....	0 – 45°
Cross cut:	
0° x 0°:	60 x 120mm
Mitre cut:	
45° x 0°:	60 x 80mm
Bevel cut:	
0° x 45°:	33 x 120mm
Compound mitre cut:	
45° x 45°:	33 x 80mm
Sound pressure level (LpA)*:	91.8dB(A)
Sound power level (LWA)**:	108.26dB(A)
Uncertainty (K):	3dB(A)
Weight (nett)	6.4kg

* *Continuous A-Weighted Sound Pressure Level at the workstation in accordance to and declared according to EN62841.*

** *The typical A-Weighted noise level determined to EN62841.*

4.3 HANDLING AND STORAGE

- Care must be taken when handling this product.
 - Dropping this power tool could have an effect on its accuracy and could also result in personal injury. This product is not a toy and must be respected.
- Environmental conditions can have a detrimental effect on this product if neglected.
 - Exposure to damp air can gradually corrode components.
 - If the product is unprotected from dust and debris, components will become clogged.
 - If not cleaned and maintained correctly or regularly, the machine will not perform at its best.

5. HEALTH AND SAFETY INFORMATION

5.1 GENERAL SAFETY INSTRUCTIONS FOR POWER TOOL USE

When using any type of power tool there are steps that should be taken to make sure that you, as the user, remain safe.

Common sense and a respect for the tool will help reduce the risk of injury.

Read the instruction manual fully. Do not attempt any operation until you have read and understood this manual.

Most important you must know how to safely start and stop this machine, especially in an emergency.

Keep the work area tidy and clean. Attempting to clear clutter from around the machine during use will reduce your concentration. Mess on the floor creates a trip hazard. Any liquid spilt on the floor could result in you slipping.

Find a suitable location. If the machine is bench mounted, the location should provide good natural light or artificial lighting as a replacement. Avoid damp and dust locations as it will have a negative effect on the machine's performance. If the machine is portable do not expose the tool to rain. In all cases do not operate power tools near any flammable materials.

Keep bystanders away. Children, onlookers and passers by must be restricted from entering the work area for their own protection. The barrier must extend a suitable distance from the tool user.

Unplug and house all power tools that are not in use. A power tool should never be left unattended while connected to the power supply. They must be housed in a suitable location, away locked up and from children. This includes battery chargers.

Do not overload or misuse the tool. All tools are designed for a purpose and are limited to what they are capable of doing. Do not attempt to use a power tool (or adapt it in any way) for an application it is not designed for. Select a tool appropriate for the size of the job. Overloading a tool will result in tool failure and user injury. This covers the use of accessories.

Dress properly. Loose clothing, long hair and jewellery are all dangerous because they can become entangled in moving machinery. This can also result in parts of body being pulled into the machine. Clothing should be close fitted, with any long hair tied back and jewellery and neck ties removed. Footwear must be fully enclosed and have a non-slip sole.

Wear personal protective equipment (PPE). Dust, noise, vibration and swarf can all be dangerous if not suitably protected against. If the work involving the power tool creates dust or fumes wear a dust mask. Vibration to the hand, caused by operating some tools for longer periods must be protected against. Wear vibration reducing gloves and allow long breaks between uses. Protect against dust and swarf by wearing approved safety goggles or a face shield. These are some of the more common hazards and preventions, however, always find out what hazards are associated with the machine/work process and wear the most suitable protective equipment available.

Do not breathe contaminated air. If the work creates dust or fumes connect the machine (if possible) to an extraction system either locally or remotely. Working outdoors can also help if possible.

Move the machine as instructed. If the machine is hand held, do not carry it by the power supply cable. If the product is heavy, employ a second or third person to help move it safely or use a mechanical device. Always refer to the instructions for the correct method.

Do not overreach. Extending your body too far can result in a loss of balance and you falling. This could be from a height or onto a machine and will result in injury.

Maintain your tools correctly. A well maintained tool will do the job safely. Replace any damaged or missing parts immediately with original parts from the manufacturer. As applicable, keep blades sharp, moving parts clean, oiled or greased, handles clean, and emergency devices working.

Wait for the machine to stop. Unless the machine is fitted with a safety brake, some parts may continue to move due to momentum. Wait for all parts to stop, then unplug it from the power supply before making any adjustments, carrying out maintenance operations or just finishing using the tool.

5. HEALTH AND SAFETY INFORMATION

Wait for the machine to stop. Unless the machine is fitted with a safety brake, some parts may continue to move due to momentum. Wait for all parts to stop, then unplug it from the power supply before making any adjustments, carrying out maintenance operations or just finishing using the tool.

Remove and check setting tools. Some machinery requires the use of additional tools or keys to set, load or adjust the power tool. Before starting the power tool always check to make certain they have been removed and are safely away from the machine.

Prevent unintentional starting. Before plugging any machine in to the power supply, make sure the switch is in the OFF position. If the machine is portable, do not hold the machine near the switch and take care when putting the machine down, that nothing can operate the switch.

Carefully select an extension lead. Some machines are not suitable for use with extension leads. If the tool is designed for use outdoors, use an extension lead also suitable for that environment. When using an extended lead, select one capable of handling the current (amps) drawn by the machine in use. Fully extend the lead regardless of the distance between the power supply and the tool. Excess current (amps) and a coiled extension lead will both cause the cable to heat up and can result in fire.

Concentrate and stay alert. Distractions are likely to cause an accident. Never operate a power tool if you are under the influence of drugs (prescription or otherwise), including alcohol or if you are feeling tired. Being disorientated will result in an accident.

Have this tool repaired by a qualified person. This tool is designed to conform to the relevant international and local standards and as such should be maintained and repaired by someone qualified, using only original parts supplied by the manufacturer. This will ensure the tool remains safe to use.

5.2 SAFETY INSTRUCTIONS FOR MITRE SAWS

Mitre saws are intended to cut wood or wood-like products. They cannot be used with abrasive cut-off wheels for cutting ferrous material such as bars, rods, studs, etc. Abrasive dust causes moving parts such as the lower guard to jam. Sparks from abrasive cutting will burn the lower guard, the kerf insert and other plastic parts.

Use clamps to support the workpiece whenever possible. If supporting the workpiece by hand, you must always keep your hand at least 100 mm from either side of the saw blade. Do not use this saw to cut pieces that are too small to be securely clamped or held by hand. If your hand is placed too close to the saw blade, there is an increased risk of injury from blade contact.

The workpiece must be stationary and clamped or held against both the fence and the table. Do not feed the workpiece into the blade or cut “freehand” in any way. Unrestrained or moving workpieces could be thrown at high speeds, causing injury.

Push the saw through the workpiece. Do not pull the saw through the workpiece. To make a cut, raise the saw head and pull it out over the workpiece without cutting, start the motor, press the saw head down and push the saw through the workpiece. Cutting on the pull stroke is likely to cause the saw blade to climb on top of the workpiece and violently throw the blade assembly towards the operator.

Never cross your hand over the intended line of cutting either in front or behind the saw blade. Supporting the workpiece “cross handed” i.e. holding the workpiece to the right of the saw blade with your left hand or vice versa is very dangerous.

Do not reach behind the fence with either hand closer than 100 mm from either side of the saw blade, to remove wood scraps, or for any other reason while the blade is spinning. The proximity of the spinning saw blade to your hand may not be obvious and you may be seriously injured.

5. HEALTH AND SAFETY INFORMATION

Inspect your workpiece before cutting. If the workpiece is bowed or warped, clamp it with the outside bowed face toward the fence. Always make certain that there is no gap between the workpiece, fence and table along the line of the cut. Bent or warped workpieces can twist or shift and may cause binding on the spinning saw blade while cutting. There should be no nails or foreign objects in the workpiece.

Do not use the saw until the table is clear of all tools, wood scraps, etc., except for the workpiece. Small debris or loose pieces of wood or other objects that contact the revolving blade can be thrown with high speed.

Cut only one workpiece at a time. Stacked multiple workpieces cannot be adequately clamped or braced and may bind on the blade or shift during cutting.

Ensure the mitre saw is mounted or placed on a level, firm work surface before use. A level and firm work surface reduces the risk of the mitre saw becoming unstable.

Plan your work. Every time you change the bevel or mitre angle setting, make sure the adjustable fence is set correctly to support the workpiece and will not interfere with the blade or the guarding system. Without turning the tool “ON” and with no workpiece on the table, move the saw blade through a complete simulated cut to assure there will be no interference or danger of cutting the fence.

Provide adequate support such as table extensions, saw horses, etc. for a workpiece that is wider or longer than the table top. Workpieces longer or wider than the mitre saw table can tip if not securely supported. If the cut-off piece or workpiece tips, it can lift the lower guard or be thrown by the spinning blade.

Do not use another person as a substitute for a table extension or as additional support. Unstable support for the workpiece can cause the blade to bind or the workpiece to shift during the cutting operation pulling you and the helper into the spinning blade.

The cut-off piece must not be jammed or pressed by any means against the spinning saw blade. If confined, i.e. using length stops, the cut-off piece could get wedged against the blade and thrown violently.

Always use a clamp or a fixture designed to properly support round material such as rods or tubing. Rods have a tendency to roll while being cut, causing the blade to “bite” and pull the work with your hand into the blade.

Let the blade reach full speed before contacting the workpiece. This will reduce the risk of the workpiece being thrown.

If the workpiece or blade becomes jammed, turn the mitre saw off. Wait for all moving parts to stop and disconnect the plug from the power source and/or remove the battery pack; then work to free the jammed material. Continued sawing with a jammed workpiece could cause loss of control or damage to the mitre saw.

After finishing the cut, release the switch, hold the saw head down and wait for the blade to stop before removing the cut-off piece. Reaching with your hand near the coasting blade is dangerous.

If the machine is equipped with a brake. Hold the handle firmly when making an incomplete cut or when releasing the switch before the saw head is completely in the down position. The braking action of the saw may cause the saw head to be suddenly pulled downward, causing a risk of injury.

5. HEALTH AND SAFETY INFORMATION

5.3 ADDITIONAL SAFETY INSTRUCTIONS FOR CIRCULAR SAW BLADES

Maximum speed. The maximum speed marked on the tool shall not be exceeded. Where stated, the speed range shall be adhered to.

Use of loose rings or bushes to “make up” bore sizes on circular saw blades shall not be permitted.

5.4 RESIDUAL RISK

Important note: Although the safety instructions and operating manuals for our tools contain extensive instructions for safe working with power tools, every power tool involves a certain residual risk which can not be completely excluded by safety mechanisms. Power tools must therefore always be operated with caution!

5.5 CONNECTION TO THE POWER SUPPLY

Caution: Risk of electric shock. Do not open.

This appliance is supplied with a moulded 3 pin mains plug for your safety. The value of the fuse fitted is marked on the pin face of the plug. Should the fuse need replacing, ensure the substitute is of the correct rating, approved to BS1362 and ASTA or BSI Kite marked.

ASTA 

BSI 

The fuse cover is removable with a small plain slot screwdriver. Ensure the fuse cover is replaced before attempting to connect the plug to an electrical outlet. If the cover is missing, a replacement must be obtained or the plug replaced with a suitable type.

If a replacement plug is to be fitted this must be carried out by a qualified electrician.

The damaged or incomplete plug, when cut from the cable should be disabled to prevent connection to a live electrical outlet.

This appliance is Class II† and is designed for connection to a power supply matching that detailed on the rating label and compatible with the plug fitted.

If an extension lead is required, use an approved and compatible lead rated for this appliance. Follow all the instructions supplied with the extension lead.

†*Double insulated* : This product requires no earth connection as supplementary insulation is applied to the basic insulation to protect against electric shock in the event of failure of the basic insulation.

IMPORTANT

If using an extension lead, follow the instructions that came with your lead regarding maximum load while cable is wound. If in doubt, ensure that the entire cable is unwound. Using a coiled extension lead will generate heat which could melt the lead and cause a fire.

6. TECHNICAL DESCRIPTION

6.1 IDENTIFICATION

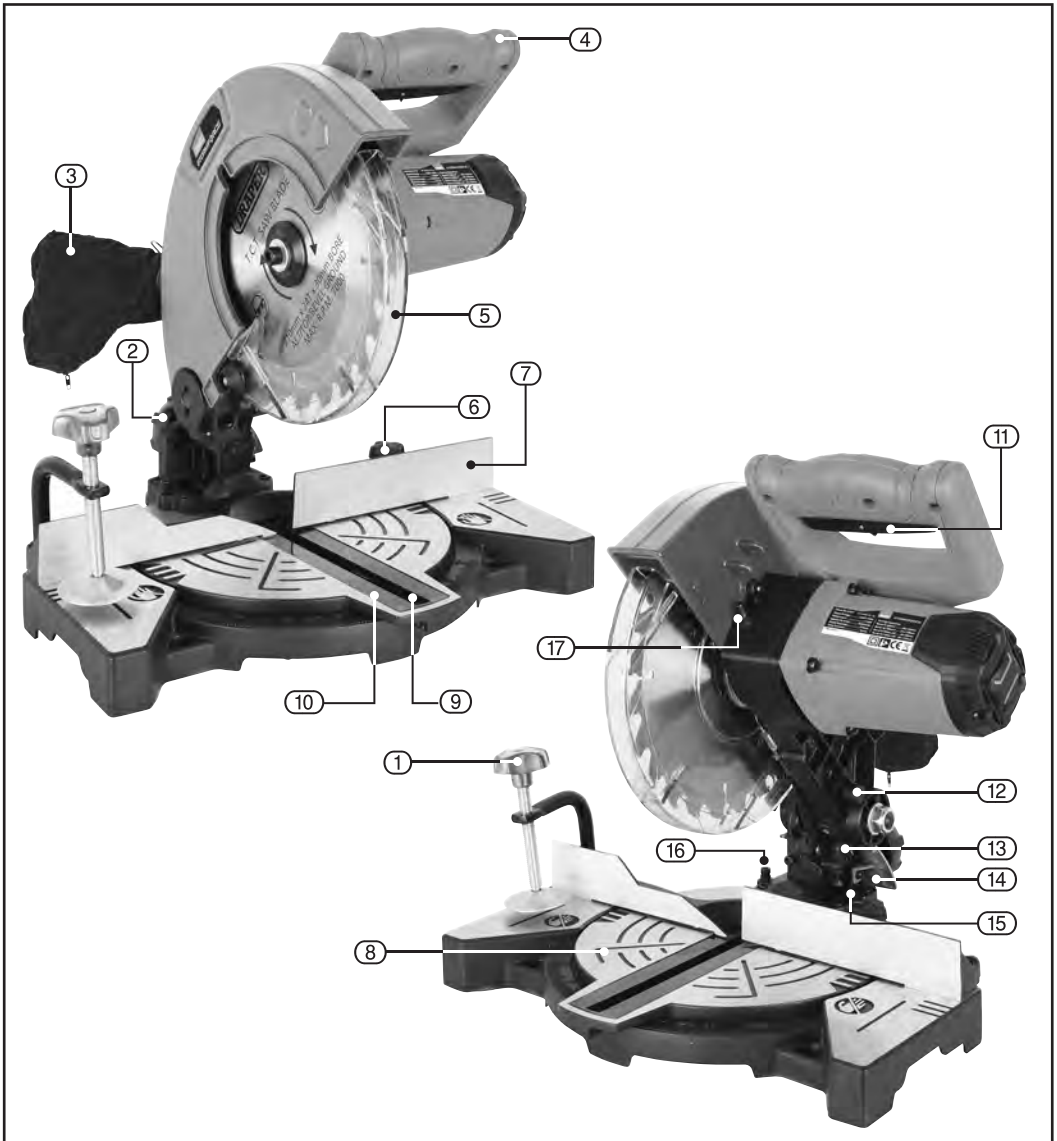

- ① Workpiece vice.
- ② Bevel locking knob.
- ③ Dust bag.
- ④ Plunge handle.
- ⑤ Lower blade guard.
- ⑥ Mitre lock knob.
- ⑦ Fence.

- ⑧ Table.
- ⑨ Mitre pointer.
- ⑩ Table insert.
- ⑪ ON/OFF trigger.
- ⑫ Saw head locking pin.
- ⑬ Depth stop.
- ⑭ Bevel pointer.

- ⑮ 0° bevel stop.
- ⑯ 45° bevel stop.
- ⑰ Spindle lock button.

7. UNPACKING AND CHECKING

7.1 PACKAGING

Carefully remove the product from the packaging and examine it for any sign of damage that may have happened during shipping. Lay the contents out and check them against the parts shown below. If any part is damaged or missing, please contact the Draper Help Line (the telephone number appears on the Title page) and do not attempt to use the product.

The packaging material should be retained at least during the warranty period, in case the machine needs to be returned for repair.

Warning!

- Some of the packaging materials used may be harmful to children. Do not leave any of these materials in the reach of children.
- If any of the packaging is to be thrown away, make sure they are disposed of correctly, according to local regulations.

7.2 WHAT'S IN THE BOX

As well as the main product, there are also several other parts not fitted or attached to it:

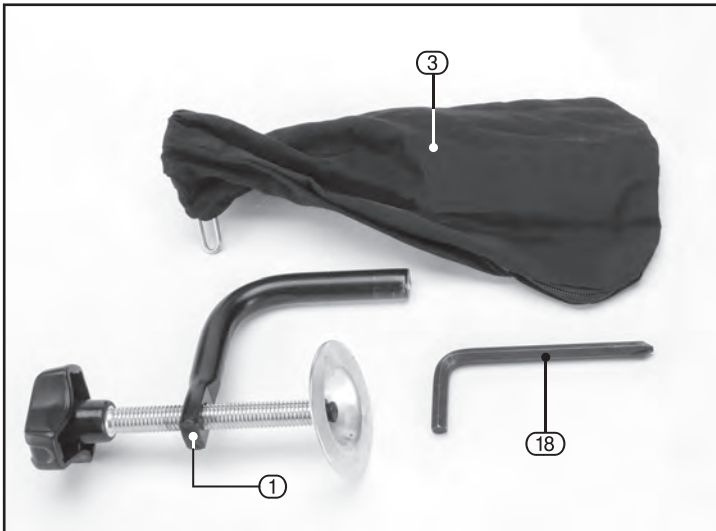

- ① Workpiece vice.
- ③ Dust bag.
- ⑱ Hex. key/cross head driver.

8. PREPARING THE COMPOUND MITRE SAW

Note: Remove the plug from the socket before carrying out adjustment, servicing or maintenance.

8.1 BENCH MOUNTING

Note: Securing the compound mitre saw. For safe working practice the saw must be mounted on a secure level surface. Using the holes in the base and four suitable bolts (not supplied) to fix the saw down. Avoid mounting the saw where large workpieces will be difficult to manoeuvre or support.

8.2 WORKPIECE VICE – FIG.1

The workpiece vice (1) can be attached either side of the table on the rear fence (7). Insert the rod on the appropriate side of the cutting head, and turn knob to clamp workpiece.

8.3 SAW HEAD LOCKING PIN – FIG.2

The saw head is locked in the down position for transport purposes and should be returned to this position when not in use. To release the saw head slightly press down on the saw head before pulling out the saw head locking pin (12).

Note: The pin does not detach from the saw. The saw head can now be raised up fully. Only carry the saw with the head locked in the down position.

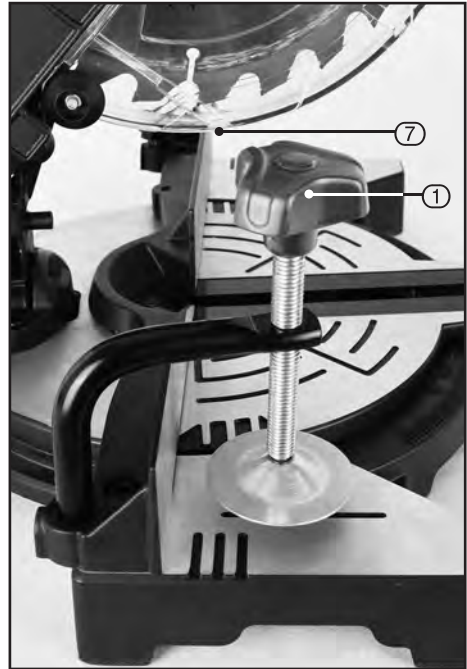

FIG.1

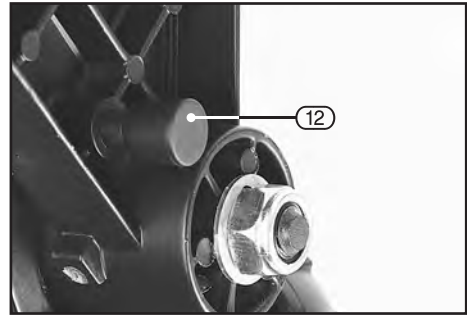

FIG.2

8. PREPARING THE COMPOUND MITRE SAW

8.4 MITRE LOCKING ASSEMBLY

– FIGS.3 – 4

It is possible to set the mitre angle from 0° to 45° with preset index (8.1) set at 0°, 5°, 10°, 15°, 22.5°, 30°, 35°, 40° and 45°.

When the desired angle is set, tighten locking knob (6) to secure.

Note: Never make any cuts until the locking knob (6) is fully tightened.

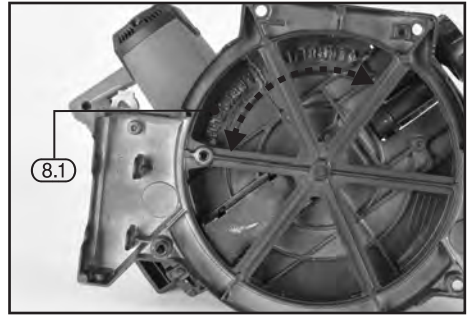

FIG.3

8.5 DUST EXTRACTION – FIG.5

The saw comes supplied with a cloth dust bag (3).

- Pinch the spring clip (3.1) open and slide onto extraction port, release clip slowly.
- Empty the dust bag regularly or when full.
- When cutting large pieces of material or cutting for a longer period, exchange the dust bag with a dust extractor to allow more efficient removal of harmful airborne dust particles.
- It may be necessary to source an appropriate adaptor to adjust the dust outlet size to suit the vacuum hose.

Note: A dust mask must be worn for any cutting operations.

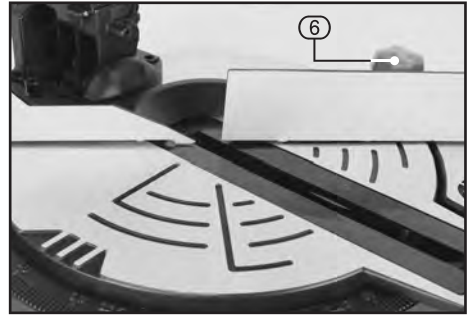

FIG.4

8.6 DEPTH OF CUT STOP – FIG.6

- In its normal position, the depth of cut stop (13) permits the saw blade to cut right through a workpiece.
- The depth adjustment screw (13.1) contacts the stop as the saw arm is lowered restricting the cut. The depth of cut can be adjusted with the adjustment screw and locked in position with lock nuts (13.1).

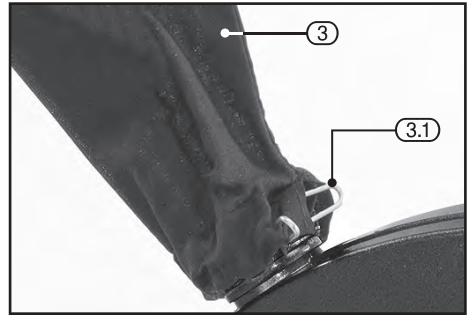

FIG.5

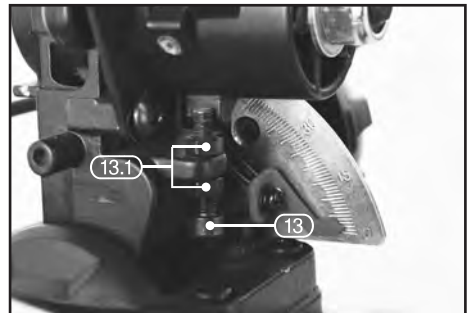

FIG.6

8. PREPARING THE COMPOUND MITRE SAW

8.7 BEVEL ADJUSTMENT – FIG.7

It is possible to set the mitre angle from 0° to 45°.

- Loosen lock (2) and adjust the bevel angle as indicated by the pointer (14) on scale (14.1). Tighten locking knob (2) to secure.

8.8 CHECKING THE TABLE TO BLADE ALIGNMENT – FIGS.8 – 10

Note: Remove the plug from the socket before carrying out adjustment, servicing or maintenance.

- Lower and lock the saw head. Set the mitre and bevel angles to zero and lock.
- Place a small engineers square flat against the table and the blade making sure that the square contacts the flat side of the blade and not the teeth.

Note: The saw head may need to be unlocked and raised up slightly to accommodate the square.

- The edge of the square should be parallel to the side of the blade. If any adjustment is required loosen the bevel locking knob (2).
- Adjust the 0° stop by turning bolt (15) then locking in position with lock nut.
- If required adjust the pointer (14) by releasing the cross head screw (14.2).
- It is possible to check the 45° bevel end stop using an engineers protractor in place of the square. If necessary adjust the 45° stop by turning bolt (16) then locking in position with lock nut.

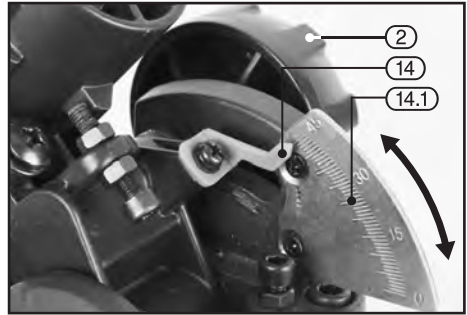

FIG.7



FIG.8

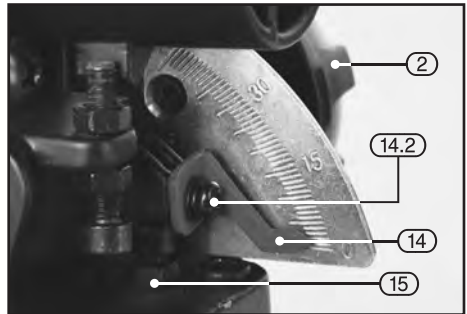

FIG.9

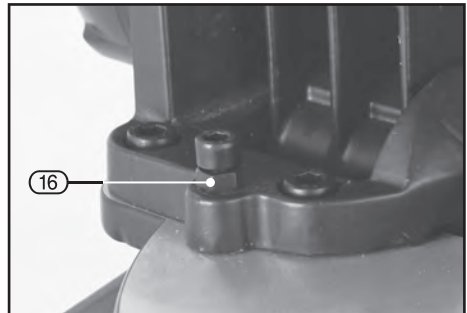

FIG.10

8. PREPARING THE COMPOUND MITRE SAW

8.9 CHECKING THE FENCE TO BLADE ALIGNMENT – FIG.11

Note: Remove the plug from the socket before carrying out adjustment, servicing or maintenance.

- Lower and lock the saw head. Set the mitre and bevel angles to zero and lock.
- Place a small engineers square flat against the fence and the blade making sure that the square contacts the flat side of the blade and not the teeth.
- The edge of the square should be parallel to the blade.
- If any adjustment is required loosen the hex. socket bolts at the rear of the fence, position the fence and against the square and re-tighten.

8.10 TABLE INSERT REPLACEMENT – FIG.12

If the table insert becomes worn or damaged it must be replaced. Remove the screws (10.1) securing the table insert (10). Ensure the replacement table insert is fitted before attempting to operate the saw.

8.11 BLADE REPLACEMENT – FIGS.13 – 14

Note: Remove the plug from the socket before carrying out adjustment, servicing or maintenance.

- With the saw head in the raised position.
- Press the spindle lock button (17) and with the 6mm hex. key (18) loosen and remove the blade securing bolt (18.1) (clockwise to loosen as the bolt has a left-hand thread).
- Remove the clamping flange, taking note of the correct orientation for re-assembly. Lower the head slightly. Rotate the clear lower blade guard so that the blade can be removed/refitted.
- Ensure the specification of the replacement blade conforms with the machine (i.e. outer diameter, width, RPM and type, e.g. woodcutting etc).
- Before fitting the new blade wipe a drop of oil on the inner and outer flanges where the arbor locates.
- Re-assemble the flanges and blade and secure.

Note: Install the blade with the direction of rotation arrow matching the direction of rotation arrow on the blade guard. The teeth face downward at the front of the saw.

Note: This compound mitre saw is not designed to cut metal or masonry.



FIG. 11

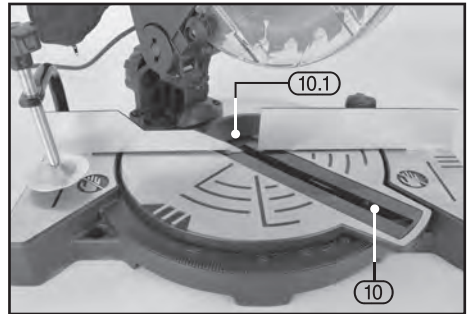

FIG. 12

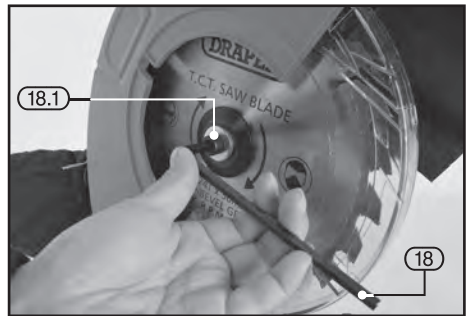

FIG. 13

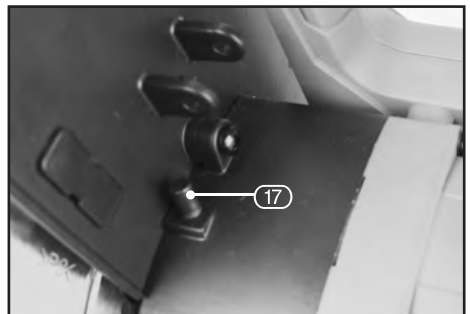

FIG. 14

9. BASIC SAW OPERATIONS

Warning! For your own safety, read and understand all safety instructions and operating procedures throughout the manual before using this machine.

9.1 STARTING THE COMPOUND MITRE SAW – FIG.15

The compound mitre saw is fitted with a safety switch to prevent accidental starting. To start the compound mitre saw:

- Move the lever in the centre of the trigger (11.1) to the left, then depress the trigger (11).
- To stop the saw, release the trigger.

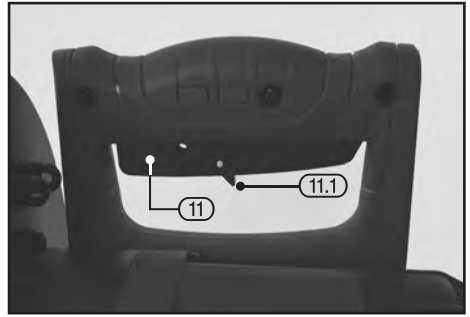

FIG.15

9.2 BODY AND HAND POSITION

Proper positioning of your body and hands when operating the compound mitre saw will make cutting easier and safer.

- Never place hands near cutting area. Place hand at least 4" from path of blade. Hold workpiece firmly to the fence to prevent movement towards the blade.
- Keep hands in position until trigger has been released and the blade has completely stopped. Before making a cut, make a "dry run" with the power off so you can see the path of the blade.

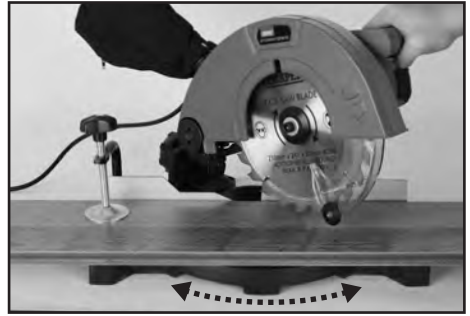

FIG.16

Warning! Do not try to cut short pieces, you cannot properly support the workpiece and hold down the workpiece by hand and keep your hand the required distance from the blade.

9.3 MITRE CUT – FIG.16

When a mitre cut is required, move the saw to the desired angle. Do not stand in front of the saw table. Move with the handle to the mitre angle to make the cut.

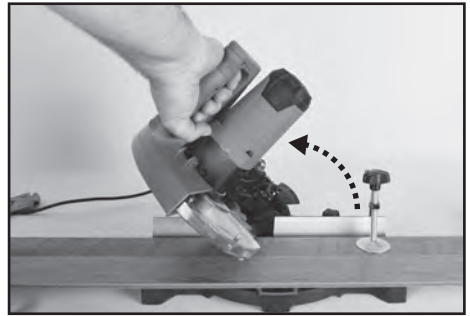

FIG.17

9.4 BEVEL CUT – FIG.17

When a bevel cut is required, tilt the blade to the desired bevel angle. Stand to the left side of the handle to make the cut.

9.5 COMPOUND CUT – FIG.18

When a compound cut is required, select the correct bevel and mitre position. Move with the handle to the mitre angle to make the cut.

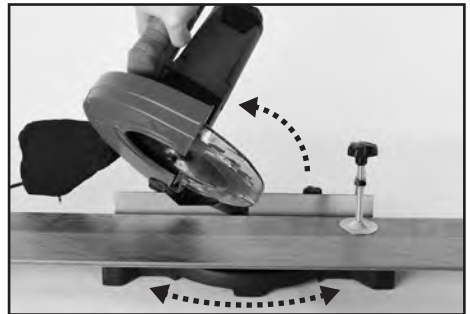

FIG.18

9. BASIC COMPOUND MITRE SAW OPERATIONS

9.6 CUTTING CURVED OR WARPED MATERIAL – FIGS.19 – 20

Before cutting a workpiece, check to make sure it is flat. If it is curved or warped, the workpiece must be positioned and cut as illustrated.

- Do not position workpiece incorrectly or try to cut the workpiece without the support of the fence. This will cause pinching of the workpiece on the blade.
- The workpiece could suddenly jump or move and your hand could hit the blade.

9.7 WORKPIECE SUPPORT

Long workpieces need extra support during cutting.

- Extra support must be placed under the workpiece so the workpiece does not sag and the hand holding the workpiece is positioned 4" or more from the blade path.
- The support must let the workpiece lay flat on the machine table and be worktable during the cutting operation.

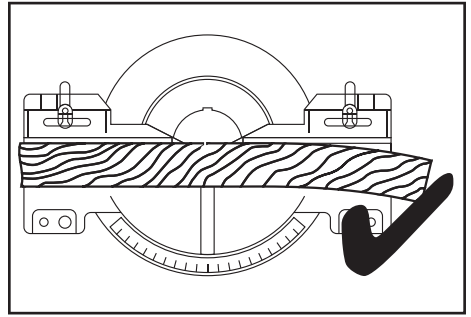

FIG.19

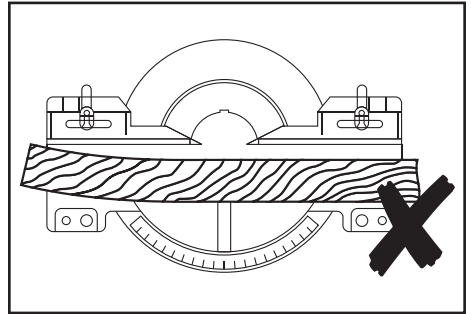

FIG.20

10. MAINTENANCE AND TROUBLESHOOTING

Regular inspection and cleaning reduces the necessity for maintenance operations and will keep your tool in good working condition.

The motor must be correctly ventilated during tool operation. For this reason avoid blocking the air inlets. After use disconnect the tool from the power supply and vacuum the ventilation slots.

If the replacement of the supply cord is necessary, this has to be done by the manufacturer or his agent in order to avoid a safety hazard.

Always unplug the power cable before any maintenance check on this compound mitre saw.

Danger! Never put lubricants on the blade whilst it is spinning.

Warning! To avoid injury from unexpected starting or electrical shock, unplug the power cable before working on the saw.

Warning! For your safety, this saw is double insulated. To avoid electrical shock, fire or injury, use only parts identical to those identified in the parts list, reassemble exactly as original assembly to avoid electrical hazards.

10.1 BLADE GUARD

Do not use the saw without the lower guard. The lower blade guard is attached to the saw for protection. Should the lower guard become damaged, do not use the saw until damaged guard has been replaced. Develop a regular check to make sure the lower guard is working properly. Clean the lower guard of any dust or build up with a damp cloth, with the power supply disconnected.

Caution! DO NOT use solvents on the guard. They could make the plastic 'cloudy' and brittle.

Warning! When cleaning lower guard, unplug the saw from the outlet to avoid unexpected start-up or electrical shock.

10.2 SAWDUST

Periodically, sawdust will accumulate under the worktable, base and around the switch mechanisms. This could cause difficulty in the movement of the worktable when setting up a mitre cut or switching operations. Frequently vacuum up the sawdust.

10.3 RECOMMENDED ACCESSORIES

Warning! To avoid injury from unsafe accessories, use only Draper accessories.

10.4 PROHIBITED ACCESSORIES

The use of any cutting tool except saw blades which meet the requirement under recommended accessories is prohibited. Do not use accessories such as shaper cutters or dado sets. Ferrous and non-ferrous metal cutting and the use of abrasive wheels are prohibited.

10.5 LUBRICATION

All the ball bearings are sealed and lubricated for life and will require no maintenance.

10.6 CLEANING

After use, wipe off chips and dust adhering to the tool with a cloth or the like. Keep the blade guard clean. Lubricate the sliding portions with machine oil to prevent rust.

To maintain product SAFETY and RELIABILITY, repairs and, any other maintenance or adjustment should be performed by your nearest authorised service centre.

10. MAINTENANCE AND TROUBLESHOOTING

10.7 TROUBLESHOOTING GUIDE

Note: Remove the plug from the socket before carrying out adjustment, servicing or maintenance.

Problem	Possible Cause	Remedy
Motor does not start.	<ol style="list-style-type: none">1. Fuse.2. Brushes worn.3. Other.	<ol style="list-style-type: none">1. Replace/reset time delay fuse or circuit breaker.2. Have brushes replaced by an authorised service agent.3. Contact an authorised service agent.
Poor cutting performance.	<ol style="list-style-type: none">1. Saw blade blunt.2. Saw blade incorrectly mounted.3. Incorrect saw blade selection.	<ol style="list-style-type: none">1. Stop machine immediately. Replace saw blade.2. Stop machine immediately. Remove and refit saw blade as per instructions.3. Seek advice on suitable saw blades.
Saw vibrates.	<ol style="list-style-type: none">1. Saw blade distorted.2. Saw blade incorrectly mounted.	<ol style="list-style-type: none">1. Stop machine immediately and replace blade.2. Stop machine immediately. Remove and refit saw blade as per instructions.
Mitre position difficult to move.	Build up of sawdust under table.	Vacuum up sawdust.

11. OPTIONAL ACCESSORIES

11.1 OPTIONAL ACCESSORIES

A full range of accessories are available from Draper Tools.

Please visit our website for details: www.drapertools.com

12. DISPOSAL

12.1 DISPOSAL

- At the end of the machine's working life, or when it can no longer be repaired, ensure that it is disposed of according to national regulations.
- Contact your local authority for details of collection schemes in your area.

In all circumstances:

- Do not dispose of power tools with domestic waste.
- Do not incinerate.
- Do not dispose of WEEE* as unsorted municipal waste.



* *Waste Electrical & Electronic Equipment.*

13. EXPLANATION OF SYMBOLS

13.1 EXPLANATION OF SYMBOLS



Read the instruction manual.



Wear face mask and safety glasses.



Wear ear defenders.



Wear protective gloves.



Do not abandon into the environment.



Keep out of the reach of children.



Warning!



Class II construction
(Double insulated).



WEEE –
Waste Electrical &
Electronic Equipment.
*Do not dispose of Waste Electrical
& Electronic Equipment in with
domestic rubbish.*

CONTACTS

Draper Tools Limited, Hursley Road,
Chandler's Ford, Eastleigh, Hampshire. SO53 1YF. U.K.

Help line: (023) 8049 4344

Sales Desk: (023) 8049 4333

Internet: drapertools.com

E-mail: sales@drapertools.com

General Enquiries: (023) 8026 6355

Service/Warranty Repair Agent:

For aftersales servicing or warranty repairs, please contact the
Draper Tools Help line for details of an agent in your local area.

YOUR DRAPER STOCKIST

TACH0620

©Published by Draper Tools Limited.

No part of this publication may be reproduced, stored in a retrieval system or transmitted in any form or by any means, electronic, mechanical photocopying, recording or otherwise without prior permission in writing from Draper Tools Ltd.