

HYUNDAI
POWER PRODUCTS

PRESSURE WASHER HYW1600E

Instruction Manual



GENUINE PRODUCT OF
HYUNDAI CORPORATION

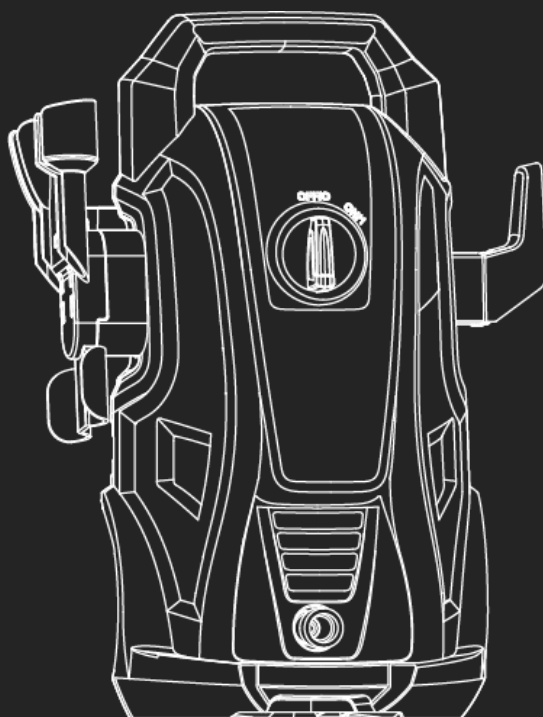

WARNING: Read the instructions carefully before use.

Iss: Jan/25



Contents

Introduction.....	3	Specifications.....	41
Safety Information.....	4-14	Recycling And Disposal.....	42
Understand Your Machine.....	4	Declaration Of Conformity.....	43
Personal Safety.....	4-5	Notes.....	44-45
Inspect Your Machine.....	5-6	Useful Information.....	46
Work Area.....	6	Our YouTube Channel.....	46
During Use.....	7-8	Warranty.....	46
Electricity.....	9-10	Manual Updates.....	46
Double Insulated Devices.....	10	Returning Your Product.....	46
Vibrations.....	11	Leaving A Review.....	46
Noise.....	11	Ordering Spare Parts.....	46
Residual Risks.....	11	Product Record.....	47
Intended Use.....	12	Contact Us.....	48
Personal Protective Equipment.....	13		
Symbols On The Machine.....	14		
Unboxing.....	15		
In The Box/ Features.....	16-17		
Assembly.....	18-32		
Assembly Overview.....	18		
Attach Lance/Trigger Gun Holder.....	18		
Attach High Pressure Hose Holder.....	19		
Attach Water Inlet Adapter.....	20		
Attach Hose To Machine.....	21		
Attach High Pressure Hose To Gun.....	22		
Attach Water Supply Hose.....	23		
Attach Accessories.....	24-32		
Operation.....	33-37		
Tips For Use.....	33		
Before Starting Work.....	33		
Starting.....	34-35		
Stopping.....	36-37		
Maintenance & Care.....	38-40		
General Maintenance.....	38		
Storage.....	38		
Cleaning.....	38		
Replacement Parts/Spares.....	39		
Troubleshooting.....	40		

Introduction

Thank You For Purchasing Your HYUNDAI Product

We work very hard to give all of our customers the best possible service. If you have any problems, before leaving negative feedback, please contact us to give us a chance to resolve the issue. We would be delighted if you left us positive feedback! Thank you for purchasing this product.

Important!



WARNING: READ THE INSTRUCTION BOOKLET THOROUGHLY BEFORE USING THE MACHINE. Keep for future reference and pass it on if the machine is loaned or sold to another user.

This manual has been produced by Hyundai Power Products and should be kept with the product. Please read and understand these instructions before you use your product. Failure to do this may result in personal injury or damage to the product.

The safety precautions and warnings are to ensure your safety and protect you from harm or damage to the product.

The information contained in this manual was accurate at the time of production, however HYUNDAI Power Products may make modifications to the product without notification.

Safety Information

Understand Your Machine

- **WARNING!** You must read these instructions carefully before operating the machine. Make sure that you are familiar with the controls and properly operate the machine. You must learn how to stop the machine quickly. If you do not follow the warnings and instructions, it may result in fire and/or serious injury. Make sure to save all warnings and instructions for future reference.
- Read this manual and labels affixed to the machine to understand its limitations and potential hazards.
- Be thoroughly familiar with the controls and their proper operation. Know how to stop the machine and disengage the controls quickly.
- If the unit is to be used by someone other than original purchaser, or is to be loaned, rented, or sold, always provide this manual and any needed safety training before operation. The user can prevent and is responsible for accidents or injuries that may occur to themselves, to other people, or to property.
- Do not force the machine beyond its limits. Use the correct machine for your application.
- Know how to stop the machine quickly in case of emergency. Understand the use of all controls.
- ALL MAINTENANCE other than that listed in this manual, should be carried out by professionally trained and certified personnel.
- When using this machine for the first time and before actual work, you **MUST** learn how to handle the machine from an experienced or skilled person.

Personal Safety

- **WARNING!** Never allow children or people unfamiliar with these instructions to use the product. Local regulations can restrict the minimum age of the operator.
- Keep children, pets, and other people not using the unit away from the work area (at least 15m). Be alert and shut off the unit if anyone enters work area. Keep children under the watchful care of a responsible adult.
- Stay alert, watch what you are doing and use common sense when operating the machine. Never operate the machine when unwell or tired, or if you have taken alcohol, medicine, drugs or any substances which may slow your reflexes and compromise judgment. A moment of inattention while operating the machine may result in serious personal injury.
- Appropriate Personal Protective Equipment (PPE), **MUST** be worn at all times when operating or repairing the machine. Always wear anti-slip and resistant work footwear and long trousers while using the machine. Do not use the machine when barefoot, wearing sandals or similar lightweight footwear. Do not wear chains, bracelets or clothing that is loose fitting or hanging ties or cords. Tie long hair back. Always wear protective earplugs. Loose clothes, jewellery, or long hair can be caught in moving parts. Protect eyes, face, and head from objects that may be thrown from the unit. Always wear safety goggles or safety glasses with side shields when operating.
- Always keep hands and feet away from all moving parts during operation. Moving parts can cut or crush body parts. Always keep hands and feet away from all pinch points.

Safety Information

Personal Safety (Continued)

- Do not touch parts that might be hot from operation. Allow parts to cool before attempting to maintain, adjust, or service.
- Do not overreach. Keep proper footing and balance at all times. This enables better control of the machine in unexpected situations. Extending your body too far can result in a loss of balance and you may fall which will result in injury.
- Never place any part of your body where it would be in danger if movement should occur during assembly, installation, and operation, maintenance, repairing or moving.
- Keep in mind that the operator or user is responsible for accidents, hazards or unexpected events involving the machine that occur to other people or their property. It is the responsibility of the user to assess the potential risk of the area where work is being carried out. The operator or user must take all necessary precautions to ensure their own safety and that of others, especially on slopes or rough, slippery and unstable ground.
- This appliance is not intended for use by persons (including children) with reduced physical, sensory or mental capabilities, or lack of experience and knowledge, unless they have been given supervision or instruction concerning use of the appliance by a person responsible for their safety.

Inspect Your Machine

- Check your machine before starting it. Make sure all components are in good working order and securely tightened before use.
- You must check the general condition of the machine before use.
- Never operate the machine when it is in need of repair or is in poor mechanical condition. Replace damaged, missing, or failed parts before using it. Please keep the machine in safe working condition.
- Do not use the machine if the machine's switch does not turn off the machine when running. Any machine that can't be controlled with the switch is dangerous and must be replaced.
- Regularly check to see that any objects are removed from the machine area before starting it. Failure to do this may result in personal injury.
- If the machine should start to vibrate abnormally, stop the machine and check immediately for the cause. Vibration is generally a warning sign of trouble.
- Avoid accidental starting. Be sure the switch is off before transporting the machine or performing any maintenance or service on the unit. Transporting or performing maintenance or service on a machine with its switch on invites accidents.
- Do not tamper with or disable safety systems.
- Only use manufacturer-recommended attachments.
- Before using, always visually inspect to see that the components are not worn out or damaged.

Safety Information

Inspect Your Machine (Continued)

- Keep the machine in good operating condition. Operating the machine in poor or questionable condition could result in serious injury.
- Be sure all safety devices are in working order and warning labels are in place. These items are installed for your safety.

Work Area

- You must only work in daylight or with good artificial light in good visibility conditions. Do not work at night, at times of heavy fog, or at any other times when your field of vision might be limited and it would be difficult to gain a clear view of the area.
- Keep people, children and animals away from the working area.
- Operate on flat, level ground.
- Never park the machine in a place with unstable ground which could give way.
- You must be careful near ravines, ditches or embankments.
- Exercise extreme caution when operating on or crossing gravel drives, walks, or roads. Stay alert for hidden hazards or traffic.
- Do not work in the rain, when there is a thunderstorm or lightning risk, at times of strong or gale force winds, or at any other times when the weather conditions might make it unsafe to use this product. If there is bad weather conditions, do not use the machine.
- Make sure you thoroughly inspect the entire work area and remove all objects and anything that could be thrown by the machine or could damage the machine (branches, stones, wire, toys, etc). Attempting to clear the work area whilst using the machine will reduce your concentration and creates a trip hazard. Any liquid spilled on the floor may result in you slipping.
- DO NOT operate power tools in explosive atmospheres, such as in the presence of flammable liquids, gases or dust. Power tools may create sparks, which may ignite the dust or fumes.
- This machine is only for outdoor use.

Safety Information

During Use

- Never attempt to make any adjustments, while the machine is running.
- You must switch off the machine:
 - Before checking or working on the machine.
 - When transporting the machine.
 - Whenever you leave the machine unattended.
 - If the machine starts to vibrate abnormally.
- **WARNING!** If something breaks or an accident happens whilst working, you must turn off the machine immediately and move the machine away to prevent further damage. If an accident happens with injuries or third parties are injured, carry out the first aid measures most suitable for the situation immediately and contact the medical authorities for any necessary health care. Carefully remove any debris that might cause damage or harm persons or animals should it not be seen.
- Never operate the machine without the necessary components tightly secured, or without safety devices, or if the hose and/or cable is damaged or worn.
- Always disconnect the electricity and water supplies on completion of every job.
- This appliance has been designed for use with the detergent provided or the detergent specified by the manufacturer, such as a neutral shampoo based on biodegradable anionic surface active detergents. The use of other detergents or chemicals may put the appliance's safety at risk.
- Do not touch the plug and the appliance with wet hands or when barefoot.
- Do not direct the nozzle toward mechanical parts containing lubricant grease, as the grease will dissolve and spread over the surrounding ground. Vehicle tyres/tyre valves may only be cleaned from a minimum distance of 30 cm, otherwise the vehicle tyre/tyre valve could be damaged by the high-pressure jet. The first indication of this is a discoloration of the tyre. Damaged vehicle tyres/tyre valves can be dangerous and can cause accidents, which can lead to death.
- High pressure jets can be dangerous if subject to misuse. The jet must not be directed at persons, animal, live electrical equipment or the machine itself.
- High pressure hoses, fittings and couplings are important for the safety of the machine. Use only hoses, fittings and couplings recommended by the manufacturer. (it is extremely important to protect these components against damage by avoiding their improper use and protecting them against bending, knocks and scratches).
- Do not direct the jet against yourself or others in order to clean clothes or footwear.
- Risk of explosion — Do not spray flammable liquids.
- Appliance with fluid under pressure. Keep a firm hold on the gun and be prepared to take the kickback pressure. Only use the high pressure nozzle provided with the appliance.

Safety Information

During Use

- Do not leave the machine during standby for more than 5 minutes.
- Any automatic start of the machine without pressing the gun trigger is attributable to air bubbles in the water or other similar phenomena which do not imply the existence of any defects in the machine. To follow best practice in this event, ensure the hose is undamaged and fitted correctly to rule out any possibility of leaks.
- When winding and unwinding the pipe take care not to cause the high-pressure cleaner to overturn.
- Before unwinding or winding the hose, switch the machine off and release the pressure in the hose itself (switching off).
- If an extension cord is used, the plug and socket must be of watertight construction.
- DO NOT direct the spray at people, animals, live electrical equipment or the appliance.
- Do not allow the high pressure hose to bend.
- Do not put any weight on the high pressure hose.
- Do not use the high pressure hose if it is in a knot or loop.
- Never start the high-pressure cleaner without first completely unwinding the high-pressure hose.
- Make sure the high pressure hose does not have any loops or tangles.

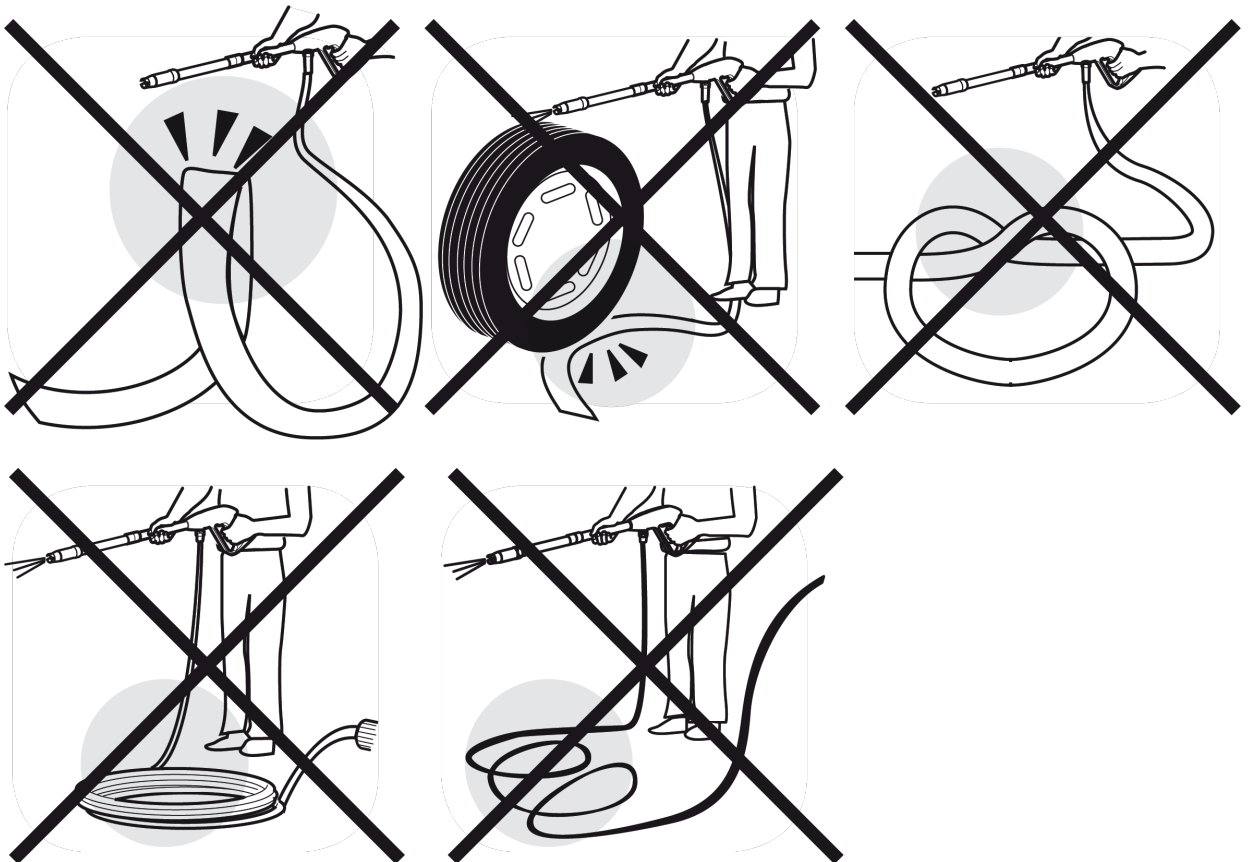

Safety Information

Electricity (Where Applicable)

DANGER : ELECTRICITY CAN KILL – NEVER WORK ON LIVE / ENERGISED EQUIPMENT.



- Prior to carrying out any maintenance work you **MUST** identify electrical isolation methods and isolate all electrical supplies.
- Prior to use and with all electrical supplies isolated, you **MUST** check all electrical cables, plugs and connectors for the following;
 - Are intact and have no signs of damage, to include but not limited to bare wires, chaffing, cuts and loose wiring.
 - If there are any signs of damage, the damaged item **MUST** be taken out of service until the damage has been repaired by a certified/authorised electrical professional.
 - All trailing cables should be routed so as not to cause any kind of trip hazard.
 - **NEVER** work on or near electricity with wet hands, wet clothing and wet gloves.

Safety Information

Electricity (Continued)

- Power tools plug must match the outlet. Never modify the plug in any way. Unmodified plugs and matching outlets will reduce risk of electric shock.
- Water entering a power tool will increase the risk of electric shock. DO NOT abuse the power cord. Never use the cord for carrying, pulling or unplugging the power tool. Keep the cord away from heat, oil and sharp edges or moving parts. Damaged or entangled cords increase the risk of electric shock. When operating a power tool, use an extension cord suitable for outdoor use. Use of a cord suitable for outdoor use reduces the risk of electric shock.
- **NOTE:** Keep the product, cables and extension leads away from pooling water during use.
- **IMPORTANT:** Make sure that the electric circuit is fused, and that the power, voltage and frequency of the motor is supported by your mains supply. Also, make sure that your power supply is earthed. Connect your machine to earth. Never open the ON/OFF switchbox. However, if it should become necessary to do so, contact a qualified electrician. Make sure that you will never touch live contacts, specifically when you plug or unplug your machine. This machine and its power cord must never get into contact with water.
- Avoid body contact with earthed or grounded surfaces such as pipes, radiators, ranges and refrigerators. There is an increased risk of electric shock if your body is earthed or grounded.
- To prevent electric shock, use only with an extension cord suitable for outdoor use. Class II appliances used in a hazardous environment such as a garden **MUST** be used with a 30mA RCD protected supply.
- Before use, check that the extension cord is in good condition. When using an extension cord, make sure to use one heavy enough to carry the current your product will draw. An undersized cord will cause a drop in line voltage resulting in loss of power and overheating.
- Do not allow any part of the machine to make contact with water while it is in operation. If the appliance becomes wet while turned off, wipe dry before starting.
- Do not touch the appliance or its plug with wet hands or while standing in water. Wearing rubber boots offers some protection.
- Before use, check the supply and extension cord for signs of damage or aging. If the cord becomes damaged during use, disconnect the cord from the supply immediately. If the supply cord is damaged, it must be replaced by the manufacturer or a qualified person in order to avoid a hazard.

Double-Insulated Appliances

In a double-insulated appliance, two systems of insulation are provided instead of grounding. Servicing a double-insulated appliance requires extreme care and knowledge of the system, and should be performed only by qualified service personnel. Replacement parts for a double-insulated appliance must be identical to the parts they replace.

Safety Information

Vibrations (Where Applicable)

- Prolonged use of hand held (operated) machines will cause the user to feel the effects of/from vibrations. These vibrations can lead to white finger (Raynaud's phenomenon) or carpal tunnel syndrome. This condition reduces the ability of the hand to feel and regulate temperature, causing numbness and heat sensations and may cause nerve damage and circulatory tissue death.
- Not all factors that lead to white finger disease are known, but cold weather, smoking and other diseases that affect blood vessels and blood circulation as well as large and long-lasting impact of shocks are considered factors in the formation of white finger. Note the following to reduce the risk of white finger and carpal tunnel syndrome;
- Wear gloves and keep your hands warm.
- Take regular breaks.
- All of the above precautions may help reduce the risk of white finger disease but not rule out the carpal tunnel syndrome. Long-term and regular users are therefore recommended to observe the condition of your hands and fingers. Seek medical attention immediately if any of the above symptoms should occur.

Noise (Where Applicable)

- The operating noise of the machine can damage your hearing. When wearing protection such as earplugs or ear defenders to protect your hearing. Long-term and regular users are advised to have hearing checked regularly. Be especially vigilant and cautious when wearing ear protection because your ability to hear alarm warnings will be reduced.
- Noise emissions for this equipment is unavoidable. Carry out noisy work at approved times and for certain periods. Limit the working time to a minimum. For your personal protection and protection of people working nearby it is also advisable for them to wear hearing protection.



- See Certificate of Conformity section for Outdoor Noise declaration of conformity.

Residual Risks

Even when the tool is used as prescribed it is not possible to eliminate all residual risk factors. The following hazards may arise in connection with the tool's construction and design:

1. Some applications of the product may require the use of a dust mask.
2. Health defects resulting from vibration emission if the power tool is being used over longer period of time or not adequately managed and properly maintained.

▲ WARNING! This machine produces an electromagnetic field during operation. This field may under some circumstances interfere with active or passive medical implants. To reduce the risk of serious or fatal injury, we recommend persons with medical implants to consult their physician and the medical implant manufacturer before operating this machine.

Safety Information

Intended Use

The HYW1600E is an electric pressure washer from HYUNDAI and is powered by a 1600W HYUNDAI motor.

The machine is manufactured according to the latest safety requirements. Every precaution is only effective when it is followed exactly.

Intended Use

The machine can be used for washing surfaces outdoors, whenever pressurised water is required to remove dirt.

This machine is not suitable for environments with an ambient temperature in excess of 32°C

User Types

This machine is intended for use by consumers, i.e. non professional operators. The machine is intended for "DIY" and domestic use only.

Improper Use

Any other usage not in keeping with the above mentioned ones may be hazardous and harm persons and/or damage things. The machine is designed for using clean water, do not use corrosive chemicals.

Safety Information

Personal Protective Equipment

Appropriate Personal Protective Equipment (PPE), MUST be worn at all times when operating or repairing the machine. No protective equipment can ensure 100% protection.

When selecting PPE, make sure it's CE marked and it suits the user in terms of size, fit, etc. If more than one item of PPE is worn at the same time, make sure they can be used together, e.g. wearing safety glasses may disturb the seal of a respirator, causing air leaks.



Hand Protection Must Be Worn

Protective electrically non-conductive gloves are highly recommended when working.



Foot Protection Must Be Worn

Non-skid heavy duty footwear are highly recommended when working.



Hearing Protection Must Be Worn

Suitable safety hearing protection is recommended.



Eye Protection Must Be Worn

Always wear safety glasses/goggles and/or face shields. Everyday eyeglasses have only impact resistant lenses; they are not safety glasses/goggles.













Protective Clothing Must Be Worn

Do not wear loose clothing, gloves, scarfs, neckties or jewellery (rings, wrist watches), which can be caught in moving parts.

Safety Information

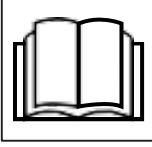
! Symbols On The Machine

We have provided safety messages in this manual and on the machine. This information alerts you to potential hazards that could hurt you or others. Please read these messages carefully. However, we may not have listed all of the possible hazards, you must also use your own judgement.

Symbol	Description	Symbol	Description
	DO NOT direct the spray at people, animals, live electrical equipment or the appliance.		Class II tools symbol.
	Disposal.		Sound power level LWA data in dB.
	This product complies with the European directives and an evaluation method of conformity for these directives was done.		The UKCA (UK Conformity Assessed) marking is a UK product marking that is required for goods being placed on the market in Great Britain (England, Wales and Scotland).
	Do not expose to rain or use in damp conditions.		To reduce the risk of injury, the user must read and understand owner's manual before using this product.
	Always wear safety goggles or safety glasses with side shields and, when necessary, a full face shield when operating this product.		To reduce the risk of injury from kickback, hold the spray lance securely with both hands when the machine is on.
	To reduce the risk of injection or injury, never direct a water stream towards people or pets or place any body part in the stream.		All tools, hoses and packaging should be sorted, taken to the local recycling centre and disposed of in an environmentally safe way.

Unboxing

⚠ WARNING : Unboxing and assembling the machine should be done on a flat, surface with enough room. Disposal of the packaging should be done in accordance with the local regulations in force.

⚠ WARNING : Some of the packaging material may be harmful to children. Keep out of reach of children.

1. Carefully remove the product from the packaging and examine it for any sign of damage caused during shipping.
2. Lay the contents out and check them. If any part is damaged or missing, you must not use the machine. Contact HYUNDAI POWER PRODUCTS immediately.
3. You must keep the packaging material in case the machine needs to be returned or repaired.
4. Ensure that you have all the accessories and tools you need for assembly and operation including the suitable personal protective equipment.

We recommend that you fill out the information in the 'Product Record' section. If you need to contact an authorised dealer or customer service, you may need to provide this information.

In The Box/Features

*Not To Scale



Descriptions on next page 

In The Box/Features

- A Main Body**
This is the main part of the pressure washer.
- B Carry Handle**
This is located the top of the machine so you can carry it.
- C On/Off Switch**
Use this to turn the machine on and off.
- D Water Outlet**
Connect the high pressure hose here.
- E Power Cable**
Plug into a standard 13A 230v UK 3-pin socket to power the machine.
- F Water Inlet**
This is where you connect the water supply.
- G Spray Lance**
You can attach the variable jet nozzle to this.
- H Detergent Bottle**
Ideal for cleaning cars, motorcycles, etc. Also for applying cleaning products to wood and stone surfaces.
- I Variable Jet Nozzle**
This creates a powerful, concentrated jet of water.
- J Pressure Washer Gun with Trigger Handle**
You must hold this with both hands when using the machine.
- K Cleaning Brush**
Use this to remove stubborn mud, grease and grime, and/or to clean wheels.
- L High Pressure Hose**
This delivers the water to the pressure washer gun.
- M Cleaning Pin**
Use this to remove debris from the variable jet nozzle.
- N Water Inlet Adapter**
This screws onto the water inlet and connects to garden hose connectors.
- O User Manual**
You must read this before use.
- P High Pressure Hose Hook**
This attaches to the side of the machine to keep the hose tidy.
- Q Pressure Washer Gun/Accessory Holder**
This slots to the side of the machine so you can hook the gun onto the main body.
- R Trigger Lock**
This locks the trigger to stop it being accidentally pressed.
- S Accessory Rack**
This slots at the back of the machine so you can attach various attachments to the main body.
- T Hose Connector**
This connects to the water outlet.

Assembly Overview

There are 7 steps to the assembly:

STEP 1: Attach The Lance/Trigger Gun Holder

STEP 2: Attach High Pressure Washer Hose/Power Cable Holder

STEP 3: Attach The Water Inlet Adapter

STEP 4: Attach High Pressure Hose To Machine

STEP 5: Attach High Pressure Hose To Trigger Gun

STEP 6: Attach Water Supply Hose

STEP 7: Attach The Accessories

STEP 1 : Attach The Lance/Trigger Gun Holder

1. Locate the bracket at the side of the machine and slot the lance/trigger gun holder into place as pictured below.

NOTE: You can use the lance/trigger gun holder to neatly secure and store the lance and trigger gun without them becoming detached from the machine.



NOTE: The picture displays the holder fitted in the correct orientation.

STEP 2 : Attach High Pressure Hose/Power Cable Holder

1. Locate the bracket at the side of the machine and slot the high pressure hose holder into place as pictured below.

NOTE: You can use the high pressure hose holder to neatly secure and store the hose without it becoming detached from the machine and/or tangled.

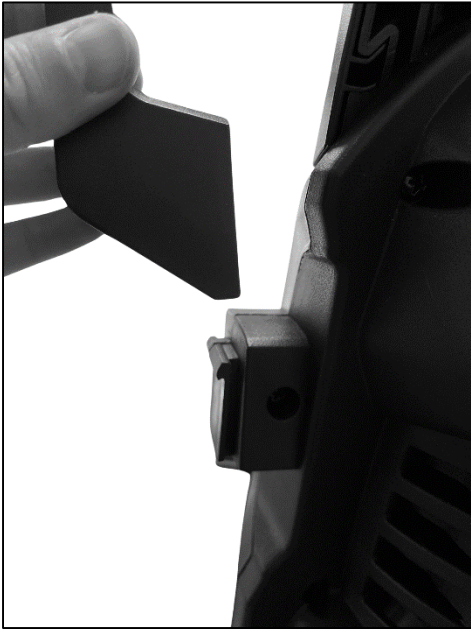

NOTE: Use the holder to store the high pressure hose as pictured (left).

STEP 3 : Attach The Water Inlet Adapter

⚠ WARNING: Ensure the ON/OFF switch is in the OFF position when connecting the water inlet adapter

1. Locate the water inlet at the rear of the machine (as pictured).
2. Screw the water inlet adapter by hand until it is firmly secured onto the machine.



STEP 4 : Attach High Pressure Hose To Machine

1. Take the end of the hose, which includes the threaded coupling, and align it to the water outlet at the front of the machine.
2. Insert the end of the hose into the water outlet and screw the coupling clockwise onto the thread of the water outlet until it is tight and secure.

NOTE: Ensure the high pressure hose is firmly connected by pulling the hose backwards to check its secure.



NOTE: This picture illustrates the high pressure hose securely fastened to the water outlet at the front of the machine.

Assembly

STEP 5 : Attach High Pressure Hose To The Trigger Gun

1. Attach the high pressure hose to the gun by pressing the button inwards (as pictured below) and guiding the hose upwards into its designated slot in a simultaneous action.

Once the button has been released and the hose has been inserted into its designated slot, the hose will remain in place.

⚠ IMPORTANT: Please ensure the hose is securely locked to the gun to avoid any leaks during operation.

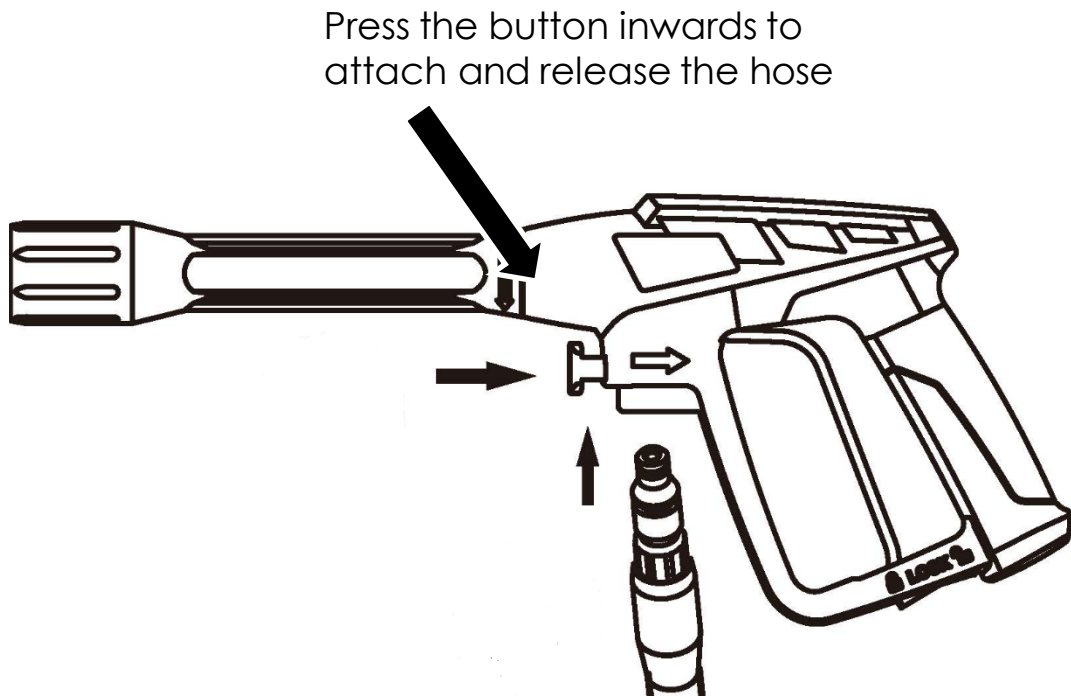

NOTE: To detach the hose from the gun, press the same button inwards and pull down on the hose to remove it from its designated slot.

⚠ WARNING: Please ensure that both the mains water supply and power supply are switched off before attaching/detaching the hose to and from the gun.

Assembly

STEP 6 : Attach Water Supply Hose

NOTE: The hose connector is included in the scope of the delivery. This is designed to connect the water supply hose to the water inlet adapter.

1. Connect the water supply hose (**not included**) to the inlet at the rear of the machine using a quick release garden hose connector.
2. Connect the hose with the quick release fitting to the inlet adapter, which is screwed onto the water inlet (**see Step 4 on Page 21**).

NOTE: You will hear an audible click as the quick release garden hose fitting connects to the inlet adapter.

3. Once you are ready to work, turn the water supply on at the tap.

⚠ IMPORTANT: DO NOT switch on the power supply until the water supply has been successfully connected to the machine via the water inlet.

⚠ IMPORTANT: Only clean or filtered water should be used for intake. The delivery of the water intake tap should be equal to the double of the maximum pump range.

- Maximum intake water temperature: 50°C
- Maximum inlet water pressure: 0.4MPa (4 bar)

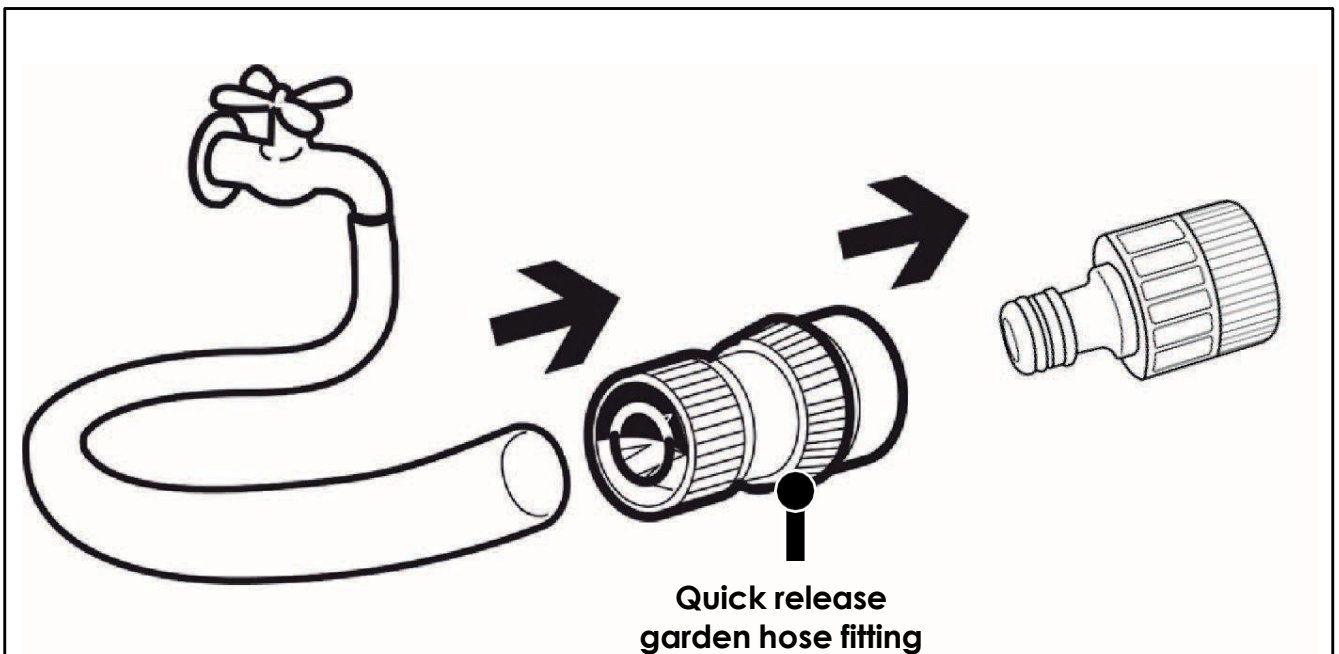

STEP 7 : Attach Accessories

Included Accessories:

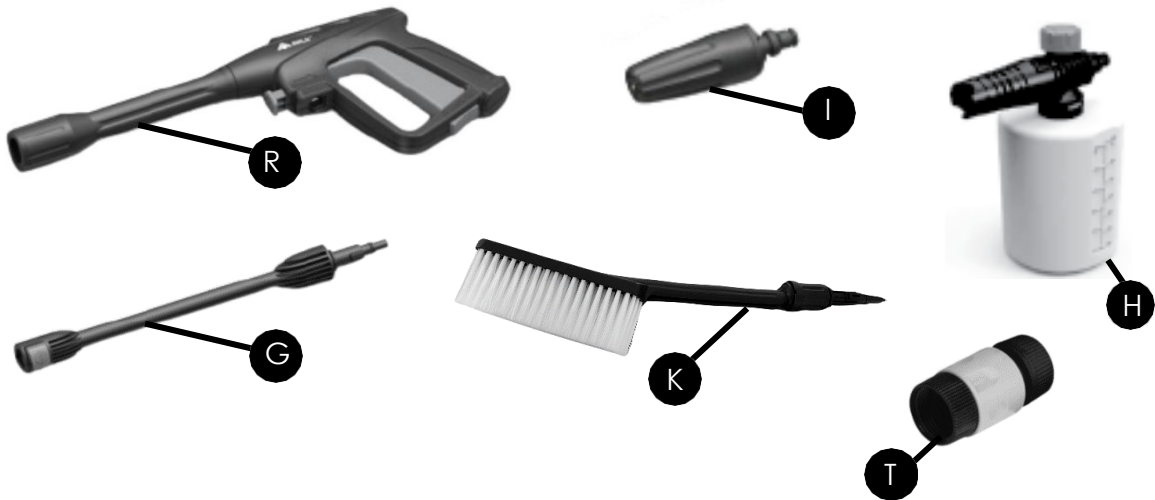

- G Spray Lance**
You can attach the adjustable nozzle to this.
- H Detergent Bottle**
Ideal for cleaning cars, motorcycles, etc. Also for applying cleaning products to wood and stone surfaces.
- I Variable Jet Nozzle**
This creates a powerful, concentrated jet of water.
- K Cleaning Brush**
Use this to remove stubborn mud, grease and grime, and/or to clean wheels.
- R Pressure Washer Gun with Trigger Handle**
You must hold this with both hands when using the machine.
- T Hose Connector**
This connects to the water outlet.

Assembly

Spray Lance and Variable Jet Nozzle

How To Attach (Spray Lance)

1. Begin by attaching the spray lance to the pressure washer gun handle.
2. Attach by aligning the two studs on the end of the spray lance to the two grooves located on the inside of the trigger gun barrel.
3. Once connected, push the spray lance towards the barrel and twist the top of the lance (area closest to the barrel) anti-clockwise until secure.

How to Remove: To detach the lance from the gun handle, push the lance towards the barrel of the gun and twist the lance clockwise to release.

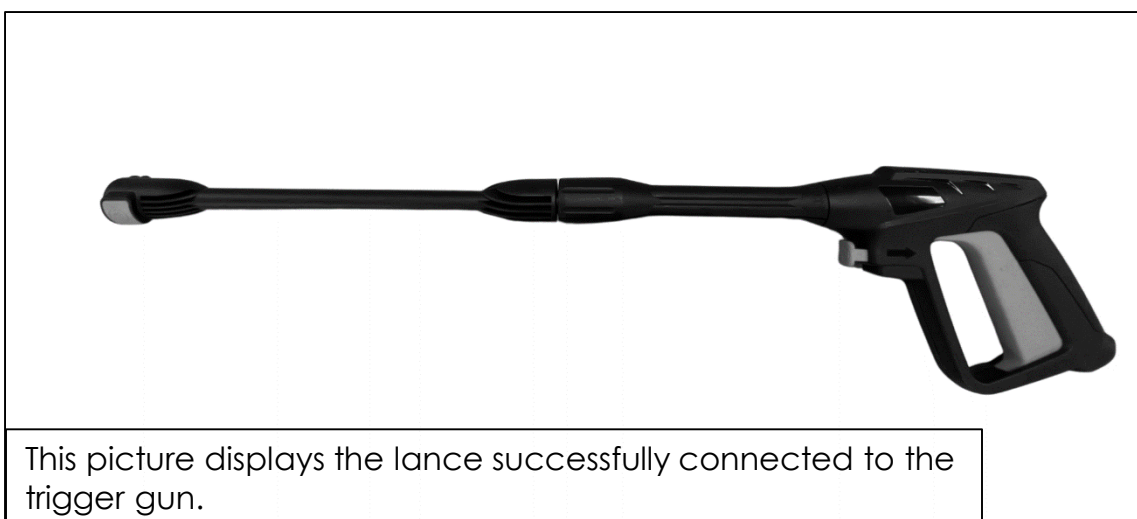
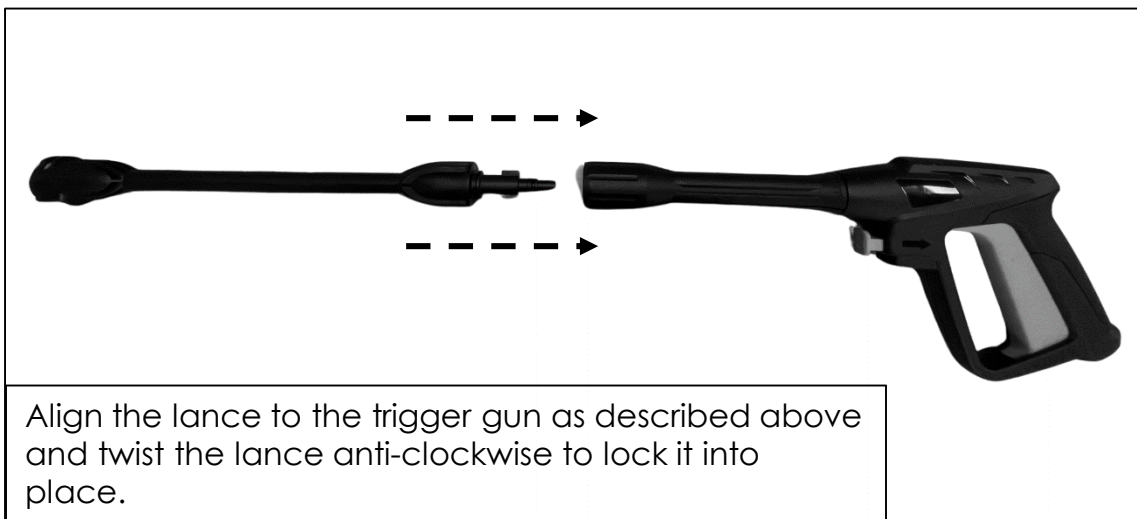

Assembly

Spray Lance and Variable Jet Nozzle (Continued)

How To Attach (Variable Jet Nozzle)

1. Attach the adjustable nozzle to the spray lance by aligning the two studs on the end of the nozzle to the two grooves located on the inside of the lance's barrel.
2. Once aligned, push the nozzle into the end of the lance's barrel.

As it connects, you will hear an audible click.

How to Remove: To detach the adjustable nozzle from the lance, press the blue 'Push' button on the end of the lance and pull the nozzle away of the lance to release.



Picture displays correct attachment of adjustable nozzle.

Variable Jet Nozzle

How to Use the Variable Jet Nozzle

By twisting the nozzle (either anti-clockwise or clockwise) you can change the width of the spray, which, in turn, adjusts the intensity of the spray.

The wider the spray, the less pressure which is ideal for delicate surfaces. The narrower the spray, the higher the pressure.

Narrow Spray

To create a narrow spray pattern, twist the nozzle anti-clockwise. The narrow setting creates the most intense spray pattern.

Wide Spray

To create a wide spray pattern, twist the nozzle clockwise. The wide setting creates the least intense spray pattern.

WARNING: DO NOT adjust the nozzle when the trigger is squeezed.



Figure 1 displays the variable nozzle fully closed and creating a narrow spray pattern.



Figure 2 displays the variable nozzle fully open and creating a wide spray pattern.

Variable Jet Nozzle (Continued)

Variable Jet Nozzle Uses

You can use the variable jet nozzle to change from a narrow spray to a wide spray. The wider the spray, the less pressure which is ideal for delicate surfaces. The narrower the spray, the higher the pressure.

Spray Pattern	Uses	Surfaces
Narrow Pattern	Intense cleaning of unpainted, hard surfaces.	Suitable for: <ul style="list-style-type: none">• Driveways• Grills• Brick or concrete paths and walkways• Unpainted brick
Wide Pattern	Cleaning of painted or delicate surfaces.	Suitable for: <ul style="list-style-type: none">• Vehicles• Wood• Painted brick• Vinyl• Painted siding

Assembly

Attaching The Cleaning Brush To The Trigger Gun

1. Begin by attaching the cleaning brush to the pressure washer gun handle.
2. Attach by aligning the two studs on the end of the cleaning brush to the two grooves located on the inside of the trigger gun barrel.
3. Once connected, push the cleaning brush towards the barrel and twist the top of its shaft (area closest to the barrel) anti-clockwise until secure.

How to Remove: To detach the cleaning brush from the gun handle, push the rotating brush towards the barrel of the gun and twist the shaft clockwise to release. You can then pull the brush away from gun barrel once it has been released.



Align the cleaning brush to the trigger gun in the orientation as described above.



This picture shows the cleaning brush successfully attached to the trigger gun.

Assembly

Foam Producer Bottle

⚠ CAUTION: Ensure the water supply and machine is switched off before attaching the foam producer bottle to the spray lance.

How To Attach

1. The variable jet nozzle must be detached in order to connect the foam producer bottle to the spray lance.
2. Guide the foam producer bottle connector into the end of the spray lance. The foam producer bottle will click into place if attached correctly.

NOTE: Ensure the foam producer bottle is securely fastened to the spray lance before operating.



NOTE: Ensure the foam producer's bottle is aligned with the handle of the gun as pictured above.

Foam System Uses

Ideal for cleaning cars, motorcycles, etc. Also for applying cleaning products to wood and stone surfaces.

⚠ CAUTION – Damage may occur to painted surfaces if detergent is allowed to dry on the surface. Wash and rinse a small section at a time. Avoid working on hot surfaces or in direct sunlight.

How To Remove

1. Detach the foam producer bottle from the spray lance by pressing the blue 'Push' button on the end of the spray lance while pulling the bottle away from the lance in a simultaneous motion.

Continued on next page 

Foam Producer Bottle (Continued)

Using the Foam Producer Bottle

1. Unscrew the lid of the foam system attachment by turning the nozzle mechanism clockwise. Pour in the detergent. Use the recommended mixing ratio advised by the detergent manufacturer. **Image 1.**
2. Reattach the nozzle assembly back onto the bottle. Ensure the gap on the nozzle mechanism's lid sits between the two projections on the rim of the bottle. Once aligned and slotted, twist the nozzle mechanism anti-clockwise to lock. **Image 2.**
3. Screw the attachment onto the gun. **Image 3.**
4. After use, make sure you wash foam system out with water.

⚠ CAUTION – Only use detergents designed for pressure washers. DO NOT use household detergents, acids, alkaline solutions, flammable materials, solvents or industrial grade solutions. This could cause damage to the pressure washer. Always test the detergent in an inconspicuous area before use.

Image 1



Image 2



Image 3



Continued on next page 

Assembly

Foam Producer Bottle (Continued)

Image 1



How to Increase/Decrease the Detergent Used

Increasing the Detergent – Twist the dial anti-clockwise to the **+ position**.

Decreasing the Detergent – Twist the dial clockwise to the **- position**.

Image 2



Image 3



How to Adjust the Intensity of Foam Spray

Wide Spray Pattern – With the nozzle facing away from you, twist the nozzle anti-clockwise to widen the spray pattern. This decreases the intensity of the spray. **(Image 2)**

Narrow Spray Pattern – With the nozzle facing away from you, twist the nozzle clockwise to produce a more intense and narrow spray pattern. **(Image 3)**

Foam Producer Bottle (Continued)

Applying the Detergent

1. Once the detergent bottle has been appropriately filled, point the gun towards the intended surface and squeeze the trigger. The detergent will come out through the nozzle.
2. Ensure you apply the detergent thoroughly so it covers the cleaning surface.
3. Allow time for the detergent to soak into the surface before lightly scrubbing the affected area with the appropriate cleaning material.
4. Once the detergent has been successfully applied for its intended use, remove the detergent bottle and replace with the variable jet nozzle.
5. Rinse the affected area with clean water.
6. Always rinse the detergent bottle thoroughly after use.

Operation

Tips For Use

- Pressure washing can be dangerous if not done correctly, it is important to prepare before working. Make sure you are wearing the correct PPE.
- Hold the pressure washer gun securely with both hands so you have control.
- Make sure you clear your work area before use. For example, if cleaning a patio, remove any furniture, plant pots and ornaments before starting. We also recommend using a broom to brush away any debris such as dirt and leaves.
- Take care when pressure washing near plants.
- If cleaning a vehicle, start at the top and work your way down.
- Do not hold nozzle too close to delicate objects.
- Make sure you read and understand the manual before use.

Before Starting Work

1. Check the condition of the cable, if damaged do not use.
2. Ensure that no objects are trapped into the machine.
3. Ensure the work area is tidy and free of any obstacles.
4. Never operate the machine if it is damaged in any way.
5. Check the pressure washer for leaks.
6. You must bleed the gun before use. Squeeze the trigger to allow any air to escape. Continue until a stream of water comes from the nozzle.

Operation

Starting

⚠ YOU MUST read and understand the full safety instruction manual before starting the machine. Ensure water and power supplies are switched OFF before starting.

WARNING: Running the pump dry will damage the pump and void the warranty.

1. Before connecting to the mains power supply, always check the switch on the machine is in the off position. **Image 1.**
2. Connect to water supply.
3. Press the On/Off switch on the machine to the ON position. **Image 2.**
4. Turn the water supply on. **Image 3.**

Image 1

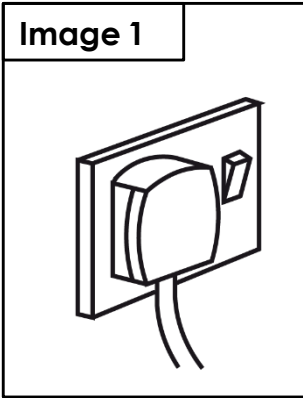
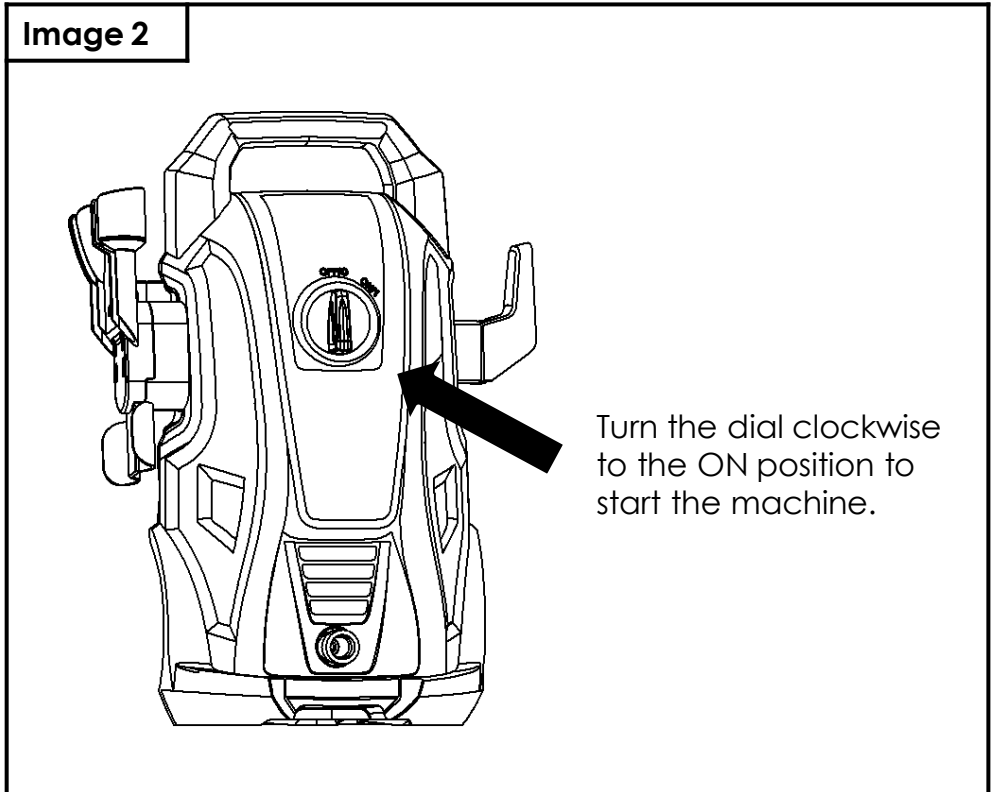
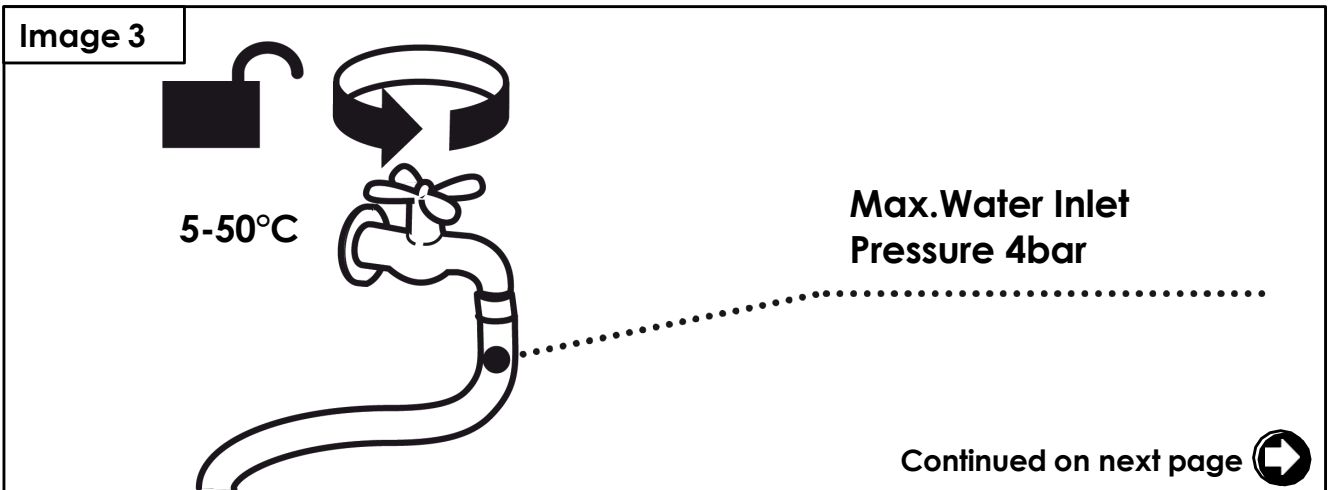

Image 2



Turn the dial clockwise to the ON position to start the machine.

Image 3



Continued on next page 

Operation

Starting (Continued)

5. If the trigger is locked, flick the trigger lock back against the trigger to unlock it.

Image 4.

6. Hold the gun with both hands and press the trigger). **Image 5.**

7. You must hold the gun with both hands so you have control. **Image 6.**

Image 4

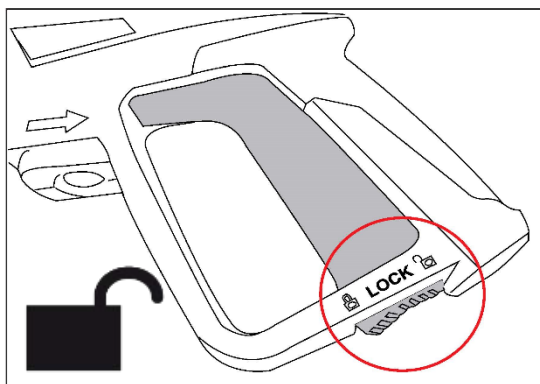
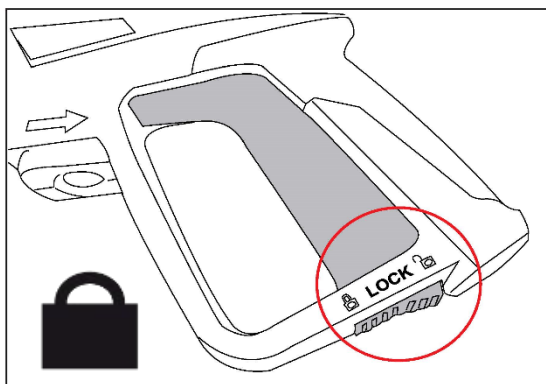
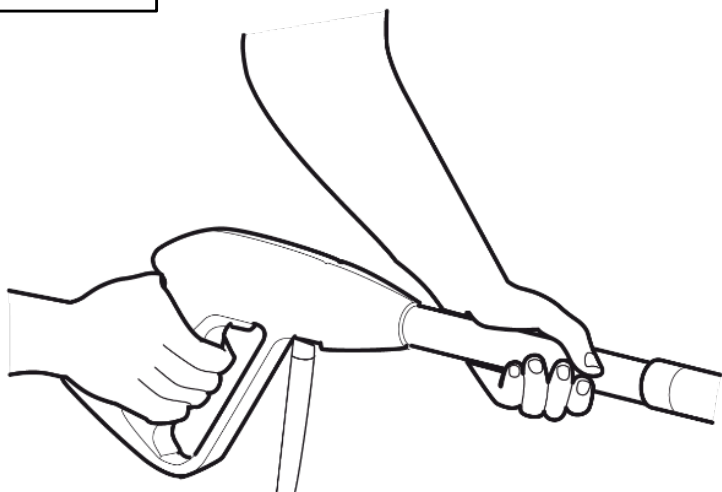

Image 5



Squeeze and hold the trigger to operate the pressure washer gun.

Image 6



Operation

Stopping

1. Press the On/Off switch to the OFF position. **Image 1.**

Image 1

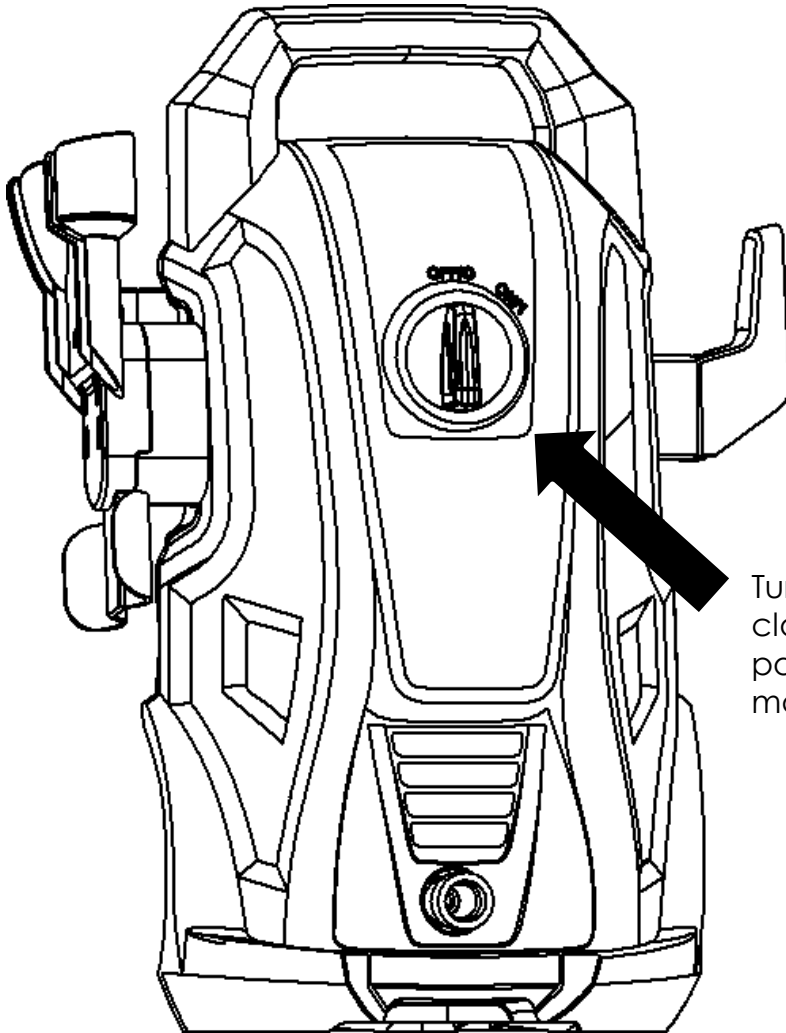

Turn the dial anti-clockwise to the OFF position to stop the machine.

Continued on next page 

Operation

Stopping (Continued)

2. Turn the water supply off. **Image 2.**
3. Unplug from the mains power supply. **Image 3.**
4. Release the trigger. **Image 4.**
5. Flick the trigger lock down to stop the trigger (**U**) from being pressed. **Image 5.** The gun is fitted with a trigger lock. Whenever you stop using the machine, it is important to operate the trigger lock to prevent accidental activation of the jet.

NOTE: Ensure that all pressure in the hose/lance is relieved before releasing the trigger. Storing the lance with trapped pressure will cause damage.

Image 2

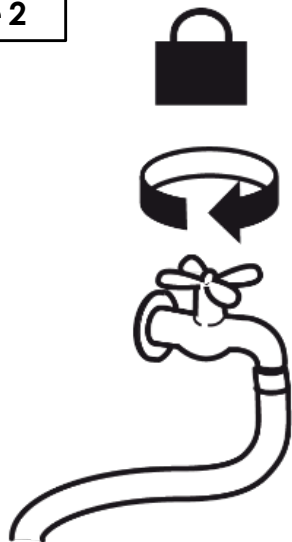

Image 3

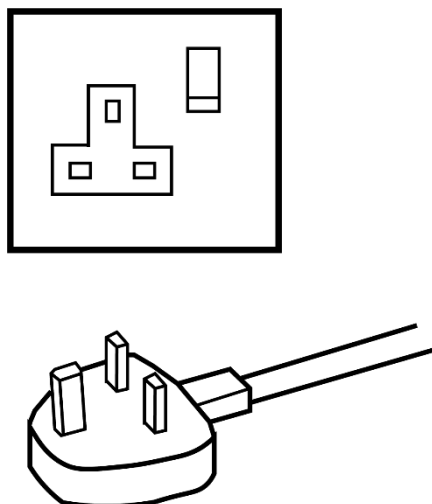
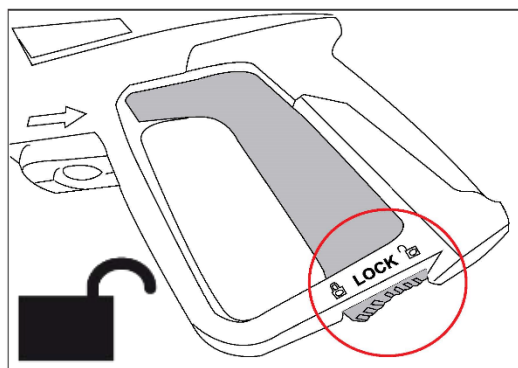
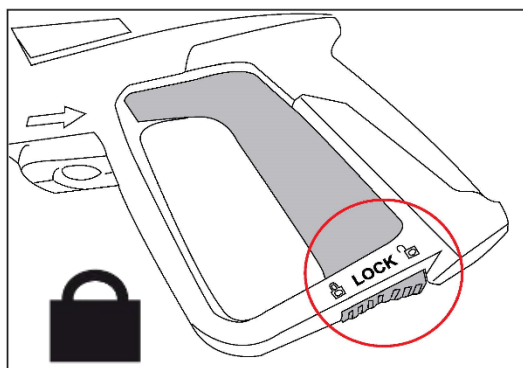

Image 4



Image 5



Maintenance & Care

General Maintenance

⚠ WARNING : Turn OFF the machine and disconnect the power cord before maintaining the machine. You need to wear proper clothing and protective gloves whenever your hands are at risk.

- Keep all nuts, bolts and screws tight to be sure the machine is in a safe working condition.
- Replace worn or damaged parts for safety. Only use manufacturer-recommended parts and accessories.
- Check the pressure washer for any leaks.

Storage

⚠ Keep the machine stored in a dry, level area away from damp, moisture and rain fall. Allow the machine to cool down before storing.

- Make sure the machine is clean and dry before storing. You can keep the cable tidy by wrapping it around the hook on the rear of the machine. You can also store the gun and accessories in the slots at the rear of the machine.
- Ensure the machine is stored in a position, where any persons cannot step on, to attempt to reach items up high, due to risk of movement.
- DO NOT store the machine near an ignition source, such as a wood stove, gas or electric heater, or an appliance or heater with a pilot light.
- Store the machine out of reach of children or anyone who is not familiar with operation.
- DO NOT stack other items on top of the machine when in storage.
- Make sure the machine is stored away from direct sunlight. Store indoors or in a safe, frost-free area during severe weather and winter months.

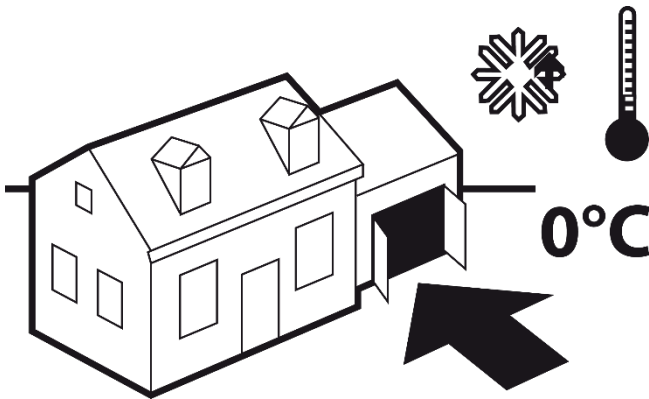

Cleaning

⚠ Always remove the electric plug from the mains supply before any cleaning is undertaken.

- Use a clean cloth to remove dirt, grease, etc.
- DO NOT use any water on any part of the main machine.
- Avoid using solvents when cleaning plastic parts. Most plastics are susceptible to damage from various types of commercial solvents and may be damaged by their use.

POWER SPARES



No Hassle Returns



Same Day Dispatch*



Over 10,000 Spare Parts



QR Code – Scan the QR code for a direct link to our website

Our Website : power-spares.co.uk

Call us : 01646 404406

Email us : sales@power-spares.co.uk

To maintain your machine in peak operating condition, proper maintenance and care are crucial. Some machines have consumable parts that will need replacement to ensure they continue operating at their full potential. Power-Spares provide manufacturer parts for all your machines, ensuring they remain in peak condition.

About Power Spares

Power-Spares has your back if you damage your lawn mower blade, find your spark plugs not sparking, or snap your recoil. Power-Spares operates under the trading name of Genpower Limited.

As part of the Genpower family, Power-Spares offers you the expertise, efficiency, and quality assurance of a large organisation. We leverage the latest warehousing, distribution, customer service, and inventory management technology to ensure you receive your parts as quickly as possible.

With extensive stock-holding of spare parts in our UK warehouses, Power-Spares is ready to assist you promptly when your machine needs repair. We're Committed to help you get back up and running as quickly as possible.

Maintenance & Care

Troubleshooting

NOTE : All corrective actions should be carried out by suitably qualified person/s.

WARNING : The appliance is equipped with a motor protection device: in case of intervention, wait a few minutes then disconnect and re-connect the product to the electric system. If this problem happens again or if the product does not start again, take the product to your service dealer.

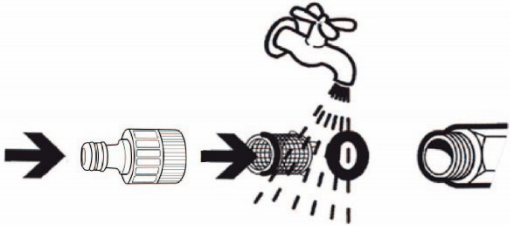
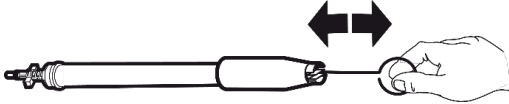
Problem	Possible Solution
Machine will not start.	Check fuse in mains plug and replace if necessary.
	Check whether the voltage shown on the rating plate corresponds to that of the power source.
	The cable could be damaged. Check the cable for damage.
Machine does not reach operational pressure.	Vent the appliance: allow the pump to operate without the high-pressure hose until water appears at the high-pressure outlet without any more bubbles. Then re-attach the high-pressure hose.
	Clean the strainer in the water connection. Clean the filter placed inside the hose coupling (if set).
	
	Check the inlet water flow rate.
	Check all inlet pipes to the pump for leaks or blockage.
Strong pressure fluctuations.	Clean the high-pressure nozzle. Remove dirt from the nozzle hole with a needle (included in box contents) and then rinse out with water from the front.
	
Pump leaks.	10 drops per minute are permissible. In the case of more serious leakage, you should contact your service dealer.

Technical Data

Specification

Model	HYW1600E
Voltage	240V
Frequency	50Hz
Power	1600W
Working Pressure	90bar
Maximum Pressure	135bar
Working Flow Rate	5.5L/min
Maximum Water Inlet Pressure	4bar
Maximum Water Inlet Temperature	50 Degrees Celsius
Declared Sound Power Level	92dB(A)
Net Weight	6.5kg

Recycling & Disposal

Recycling & Disposal

We do not offer a takeback scheme for the recovery of Waste Electrical Electronic Equipment (WEEE) & Batteries. Instead the responsibility to dispose of WEEE and/or Batteries is passed onto you by us.

So when it becomes necessary to dispose of your machine you must take it to your local Civic Amenity Site. For further information please contact your local Authority for disposal advice.

You MUST make sure that all unused oil and fuel is disposed of correctly either beforehand or at your local Civic Amenity Site.

- Certain products contain WEEE waste which should not be disposed of in your domestic waste.
- You MUST recycle WEEE in accordance with your local authority or recycling centre.
- Certain products contain batteries which should not be disposed of in your domestic waste.
- You MUST recycle batteries in accordance with your local authority or recycling centre.
- Unwanted packaging and materials should be stored and taken to a recycling centre so it can be disposed of in a manner which is compatible with the environment.

We are a Member of the VALPAK National Compliance Scheme and our registration number is RM08660. For further information about disposal please contact your Local Authority.

You can also get more advice and guidance about recycling at the following website <http://www.recycle-more.co.uk>

Should you pass this product on to another user either sold or loaned, you MUST pass on this user manual. This will make sure that all other users can use and maintain this machine safely.

Environmental Protection

1. Environmental protection should be a priority of considerable importance when using the machine, for the benefit of both social coexistence and the environment in which we live. Try not to cause any disturbance to the surrounding area.
2. You must comply with local regulations and provisions for the disposal of packaging, oils, fuel, filters, damaged parts or any elements which have a strong impact on the environment. This waste must not be disposed of as normal waste. It needs to be separated and taken to specified waste disposal centres where the material will be recycled.
3. You must comply with local regulations for the disposal of waste materials after mowing.
4. When disposing, do not pollute the environment with the machine, but hand it over to a disposal centre, in accordance with the local laws in force.

EU Declaration Of Conformity

Importer and Authorised Representative

Genpower Ltd
Isaac Way, Pembroke Dock, SA72 4RW
Country of Origin: China
Description: 1600W Pressure Washer
SKU Code: HYW1600E
Date of Issue: 10/06/2024

Regulations and Directives of Compliance

- 2011/65/EU RoHS
- EN IEC 55014-1:2021
- EN IEC 55014-2:2021
- EN IEC 61000-3-2:2019+A1:2021
- EN 61000-3-3:2013+A1:2019+A2:2021

REFERENCES TO THE RELEVANT HARMONISED SAFETY STANDARDS USED OR REFERENCES TO THE OTHER TECHNICAL SPECIFICATIONS IN RELATION TO WHICH CONFORMITY IS DECLARED:

EN 62233:2008 - This standard specifies requirements for appliances for household and similar purposes to prevent the backflow of non-potable water into the water mains.

EN 60335-2-79:2012 – This standard deals with the safety of high-pressure cleaners without traction drive.

EN 60335-1:2012+A11:2014+A13:2017+A1:2019+A2:2019+A14:2019+A15:2021 - This European Standard deals with the safety of electrical appliances for household environment and commercial purposes.

Statement of Declaration

We the importer and authorised representative of the product described confirm conformity within the provisions of applicable regulations and directives listed within this document.

Signed on Behalf of Genpower Ltd

Place of Issue: Genpower Ltd

Signatory Name: Roland Llewellyn

Position: Managing Director

R J Llewellyn
.....



Notes



Notes



Useful Information

Check Out Our YouTube Channel

Our videos on YouTube include:

- Unboxing
- Assembly of your machine
- How to service your machine
- Products in use
- 'How To' videos
- Product features

Go to YouTube and search '**Hyundai Power Products**'.

Warranty

Proof of purchase will be required before you make a warranty claim. Full warranty terms and conditions can be found on the HYUNDAI POWER PRODUCTS website:

www.hyundaipowerproducts.co.uk

Manual Updates

Our manuals are constantly being reviewed and updated. Should you find an error, omission or something unclear, please contact us for assistance. We reserve the right to make any modifications without prior notice whenever necessary.

Our latest manuals are also placed online. All our manuals can be downloaded at:

www.hyundaipowerproducts.co.uk

Returning Your Product

If you are returning your product, please contact the dealer for their returns policy.

Leaving A Review

We work very hard to give all of our customers the best possible service. If you have any problems, before leaving negative feedback, please contact us to give us a chance to resolve the issue. We would be delighted if you left us positive feedback! To leave a review, please go to:

uk.trustpilot.com/review/hyundaipowerequipment.co.uk

Ordering Spare Parts

You can find the spare part you are looking for at power-spare.co.uk

Product Record

Information

As soon as you have purchased the machine, we recommend that you fill out the following. If you need to contact an authorised dealer or customer service for information on servicing, you may need to provide the following information.

Date Of Purchase:.....

Dealer Name:.....

Dealer Phone:.....

Model Number:.....

Serial/Batch Number:.....

Contact Us

Need Help? Talk To Our Experts

Our friendly aftersales team will be more than happy to help you.



Phone

Call our team on 01646 687 880



Email

aftersales@hyundaipowerproducts.co.uk



Online Live Chat

Go to www.hyundaipowerproducts.co.uk



Post

Genpower Ltd, Isaac Way, Pembroke Dock, Pembrokeshire, SA72 4RW.



Hyundai Support Website

Go to hyundaisupport.co.uk

HYUNDAI

POWER PRODUCTS



GENUINE PRODUCT OF
HYUNDAI CORPORATION

For Inquiries, Please Contact:

GENPOWER LTD

Isaac Way, London Road,
Pembroke Dock, UK, SA72 4RW.

T: +44 (0) 1646 687 880

E: info@hyundaipowerproducts.co.uk

www.hyundaipowerproducts.co.uk

