

# SAMSUNG

# USER GUIDE

---

**Music Studio 7 (HW-LS7\*H)**

**Music Studio 5 (HW-LS5\*H)**

To receive more complete service, please register your product at [www.samsung.com](http://www.samsung.com)

Figures and illustrations in this User Manual are provided for reference only and may differ from actual product appearance.

# Contents

<b>01 Safety Information</b>	<b>3</b>	<b>06 Connecting to a TV</b>	<b>9</b>
SAFETY WARNINGS .....	3	Connecting by Wi-Fi .....	9
Precautions .....	3	Connecting to a TV that supports Dolby Atmos .....	9
<b>02 Checking the Components</b>	<b>4</b>	Using the Q-Symphony Function .....	10
<b>03 Product Overview</b>	<b>4</b>	Connecting to Non-Q-Symphony TV .....	10
Buttons .....	4	Connecting by Bluetooth .....	10
Terminals .....	5	Connecting to a TV with HDMI ARC (Audio Return Channel) Support .....	11
<b>04 Connecting Electrical Power</b>	<b>5</b>	Connecting using an Optical Cable .....	12
<b>05 Connecting a Mobile Device</b>	<b>6</b>	Using the Spacefit Sound .....	12
Connecting to the Samsung Sound App (Wireless Network) .....	6	- Connecting via WiFi Speaker .....	12
Output specifications for the SOUND MODE .....	7	- Connecting to TV .....	12
Using Group Play .....	7	<b>07 Connecting an External Device</b>	<b>12</b>
Connecting to Apple AirPlay .....	8	Connecting using an Optical Cable .....	12
Connecting by Bluetooth .....	8	<b>08 Additional Features</b>	<b>13</b>
- Notes on Bluetooth connection .....	8	Installing the WiFi Speaker (HW-LS7*H) on a Stand .....	13
- Disconnecting the Bluetooth device from a WiFi Speaker .....	8	- Screw specifications for mounting the WiFi Speaker on a stand .....	13
- Disconnecting the WiFi Speaker from the Bluetooth device .....	8	Activate/Deactivate Wi-Fi and Bluetooth .....	13
Using Instant Music Play .....	9	- To activate/deactivate Wi-Fi connection .....	13
- Setting up Instant Music Play .....	9	- To activate/deactivate Bluetooth connection .....	13
- Playing music instantly with the  Button .....	9	<b>09 Software Update</b>	<b>13</b>
		Auto Update .....	13
		USB Update .....	13
		Reset .....	14
		Security updates information .....	14
		<b>10 Troubleshooting</b>	<b>14</b>
		<b>11 License</b>	<b>15</b>

# 01 Safety Information









The following also applies to the Subwoofer and Surround Speaker SET.

## SAFETY WARNINGS

TO REDUCE THE RISK OF ELECTRIC SHOCK, DO NOT REMOVE THE COVER (OR BACK).

NO USER-SERVICEABLE PARTS ARE INSIDE. REFER SERVICING TO QUALIFIED SERVICE PERSONNEL.

Refer to the table below for an explanation of symbols which may be on your Samsung product.

	<b>CAUTION</b>	
<b>RISK OF ELECTRIC SHOCK. DO NOT OPEN.</b>		
	This symbol indicates that high voltage is present inside. It is dangerous to make any kind of contact with any internal part of this product.	
	This symbol indicates that this product has included important literature concerning operation and maintenance.	
	Class II product : This symbol indicates that a safety connection to electrical earth (ground) is not required. If this symbol is not present on a product with a power cord, the product MUST have a reliable connection to protective earth (ground).	
	AC voltage : Rated voltage marked with this symbol is AC voltage.	
	DC voltage : Rated voltage marked with this symbol is DC voltage.	
	Caution. Consult Instructions for use : This symbol instructs the user to consult the user manual for further safety related information.	

## WARNING

- To reduce the risk of fire or electric shock, do not expose this appliance to rain or moisture.
- Do not use liquid fumigators containing chemicals, such as mosquito repellent or air freshener, around the product. If steam comes in contact with the product surface or enters the product, it may cause stains or malfunction.
- For crevices or other areas that cannot be thoroughly cleaned with a cloth, use a soft cotton swab, brush, or air blower to remove dirt.

## CAUTION

- TO PREVENT ELECTRIC SHOCK, MATCH WIDE BLADE OF PLUG TO WIDE SLOT, FULLY INSERT.
- This apparatus shall always be connected to a AC outlet with a protective grounding connection.
- To disconnect the apparatus from the mains, the plug must be pulled out from the mains socket, therefore the mains plug shall be readily operable.
- Do not expose this apparatus to dripping or splashing. Do not put objects filled with liquids, such as vases, on the apparatus.
- To turn this apparatus off completely, you must pull the power plug out of the wall socket. Consequently, the power plug must be easily and readily accessible at all times.

## Precautions

1. Ensure that the AC power supply in your house complies with the power requirements listed on the identification sticker located on the bottom of your product. Install your product horizontally, on a suitable base (furniture), with enough space around it for ventilation (7~10 cm). Make sure the ventilation slots are not covered. Do not place the unit on amplifiers or other equipment which may become hot. This unit is designed for continuous use. To fully turn off the unit, disconnect the AC plug from the wall outlet. Unplug the unit if you intend to leave it unused for a long period of time.
2. During thunderstorms, disconnect the AC plug from the wall outlet. Voltage peaks due to lightning could damage the unit.
3. Do not expose the unit to direct sunlight or other heat sources. This could lead to overheating and cause the unit to malfunction.
4. Protect the product from moisture (i.e. vases), and excess heat (e.g. a fireplace) or equipment creating strong magnetic or electric fields. Unplug the power cable from the AC wall socket if the unit malfunctions. Your product is not intended for industrial use. It is for personal use only. Condensation may occur if your product has been stored in cold temperatures. If transporting the unit during the winter, wait approximately 2 hours until the unit has reached room temperature before using.
5. Make sure to rest the AC/DC Adapter flat on a table or the floor. If you place the AC/DC Adapter so that it is hanging with the AC cord input facing upwards, water or other foreign substances could enter the Adapter and cause the Adapter to malfunction.

## 02 Checking the Components

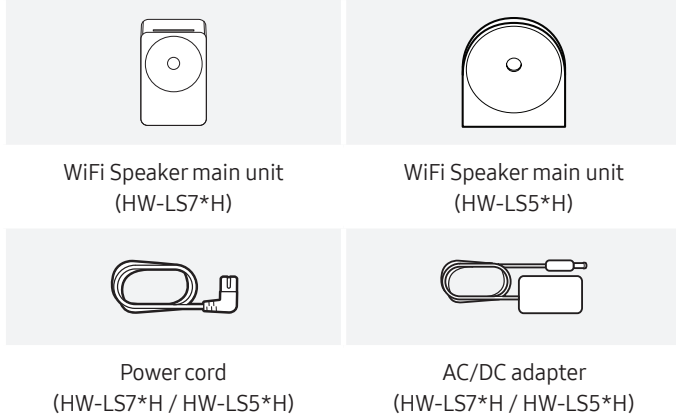

- For more information about the power supply and power consumption, refer to the label attached to the product. (Label: Bottom of the WiFi Speaker)
- To purchase additional components or optional cables, contact a Samsung Service Center or Samsung Customer Care.
- The appearance of the accessories may differ slightly from the illustrations above.

## 03 Product Overview

### Buttons

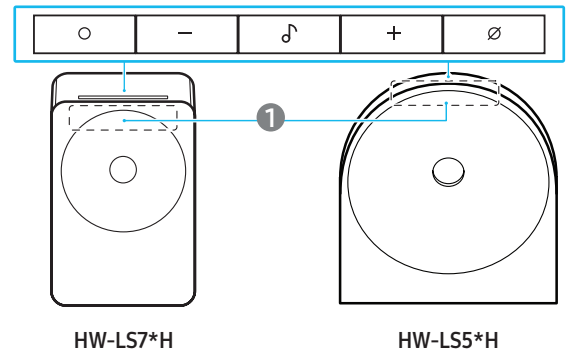

①	<p><b>LED indicator</b></p> <p>The LED Indicator flashes, glows, or changes color depending on the WiFi Speaker's current mode or status.</p> <ul style="list-style-type: none"> <li>• The Multicolor LED changes to <b>White, Cyan, Green, Red,</b> and <b>Blue</b> depending on the mode or status.</li> </ul>
○	<p><b>(Multi Function) Button</b></p> <ul style="list-style-type: none"> <li>• In standby mode, press the ○ <b>(Multi Function)</b> button to turn on the WiFi Speaker.</li> <li>• Press the ○ <b>(Multi Function)</b> button to change the mode. <ul style="list-style-type: none"> <li>- <b>LS7*H:</b> TV ARC → Wi-Fi → Bluetooth → Digital Audio In</li> <li>- <b>LS5*H:</b> Wi-Fi → Bluetooth → Digital Audio In</li> </ul> </li> </ul>
- +	<p><b>(Volume) Button</b></p> <p>Adjusts the volume.</p>
♪	<p><b>(Instant Music Play) Button</b></p> <p>The music that was playing can be resumed instantly.</p> <ul style="list-style-type: none"> <li>• Press the button to play or pause.</li> <li>• Press the button twice to skip to the next track.</li> </ul> <p>* When <b>Spotify Tap</b> is selected in the <b>Instant Music Play</b> settings of the <b>Samsung Sound</b> app, the shortcut button is assigned accordingly. In this mode, pressing the button twice launches Spotify and plays a track recommended for your listening preferences.</p>
∅	<p><b>(Mic On/Off) Button</b></p> <p>Press the button to turn the microphone on or off. When the microphone is off, the LED indicator will light red.</p> <ul style="list-style-type: none"> <li>• To switch to Bluetooth Pairing state, press and hold the ∅ <b>(Mic On/Off)</b> button on the WiFi Speaker for more than 3 seconds.</li> </ul>

## Terminals

HW-LS7\*H

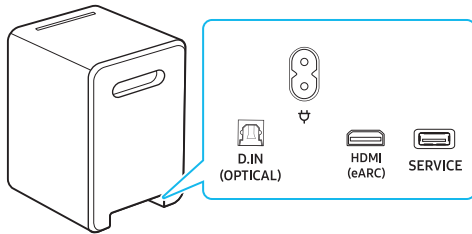

HW-LS5\*H

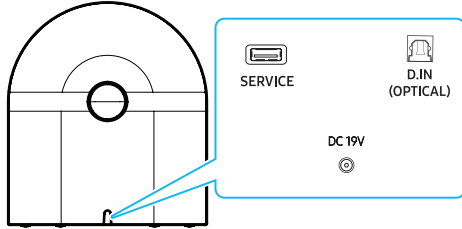

<b>D. IN (OPTICAL)</b>	Connect to a digital (optical) output terminal of a TV or external device. (Refer to " <a href="#">Connecting using an Optical Cable</a> " section.)
	Connect the power cable to this power port. (Refer to " <a href="#">Connecting Electrical Power</a> " section.)
<b>HDMI (eARC)</b>	Use this HDMI port to connect to a TV.
<b>SERVICE</b>	Use this port to update firmware.
<b>DC 19V</b>	Connect the AC/DC power adapter. (Power Supply In) (Refer to " <a href="#">Connecting Electrical Power</a> " section.)

- When disconnecting the power cable from a wall outlet, pull the plug. Do not pull the cable.
  - Do not pull the cable.
- When you turn on this unit, there will be a 4 to 5 second delay before it produces sound.

## 04 Connecting Electrical Power

For more information about the required electrical power and power consumption, refer to the label attached to the product. (Label: Bottom of the WiFi Speaker)

HW-LS7\*H

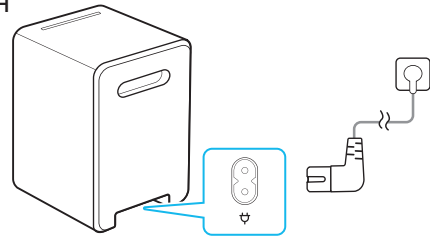

HW-LS5\*H

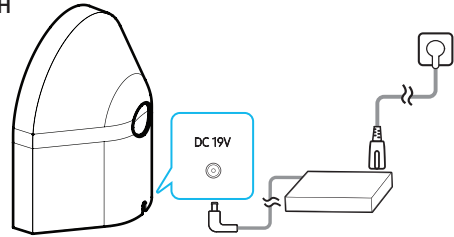

### NOTE

- If you unplug and reconnect the power cord when the product is turned on, the WiFi Speaker turns on automatically.
- Make sure to rest the AC/DC Adapter flat on a table or the floor. If you place the AC/DC Adapter so that it is hanging with the AC cord input facing upwards, water or other foreign substances could enter the Adapter and cause the Adapter to malfunction.

# 05 Connecting a Mobile Device

## Connecting to the Samsung Sound App (Wireless Network)

To connect a WiFi Speaker to a mobile device by a wireless network (Wi-Fi), the [Samsung Sound](#) app is required.

- It is required to have a certain higher version of OS for the smooth use of [Samsung Sound](#). For more version informations, please refer to the [Samsung Sound](#) App description in the OS-specific market.

### 1 - Installation



The [Samsung Sound](#) app allows you to control the functionality of and adjust the settings of the WiFi Speaker.

Download the [Samsung Sound](#) app from the app store of your mobile device, or simply scan the provided QR code and download the app.

### 2 - Device registration

- Run the [Samsung Sound](#) app on your mobile device.
- Follow the on screen instructions and add the product to your mobile device.
  - If the automatic pop-up window does not appear, press (+) on the Home screen to register the product.

#### If device search is not possible

- Connect the WiFi Speaker from the mobile device to Bluetooth.
- Tap [Devices](#) on the [Samsung Sound](#) App.
- Slide the screen to the left to select the WiFi Speaker card from [Personal Devices](#) and click [Register device in Samsung account](#) to register the device.

### 3 - Control with Samsung Sound

- With the [Samsung Sound](#) app open on your mobile device, select the WiFi Speaker that you have added.
- The settings menu will appear for the WiFi Speaker, and you can adjust the settings such as [Volume](#), [Sound Mode](#), and [Equalizer](#).

#### If another user wants to control the WiFi Speaker

- Make sure the mobile device is connected to the same Wi-Fi network as the WiFi Speaker.
- Open the [Samsung Sound](#) app and follow the on-screen instructions to complete the setup. Once the setup is finished, the WiFi Speaker can be controlled through the app.

<a href="#">Sound Mode</a>	<ul style="list-style-type: none"> <li><a href="#">Music</a> : Provides more natural and room filling sound for music content.</li> <li><a href="#">Standard</a> : Outputs the original sound.</li> <li><a href="#">Adaptive Sound</a> : Analyzes the content in real time and automatically provides the optimal sound field based on the characteristics of the content.</li> </ul>
<a href="#">Equalizer</a>	You can set the <a href="#">Bass</a> and <a href="#">Treble</a> .
<a href="#">Spacefit Sound Pro</a>	Provides optimized sound quality by analyzing the listening spaces.
<a href="#">Active Voice Amplifier Pro</a>	Analyzes external noise in real time while WiFi Speaker is playing, so that voice audio can always be heard clearly. <ul style="list-style-type: none"> <li>No data is saved during the analysis.</li> </ul>
<a href="#">Auto Volume</a>	This feature automatically adjusts the volume to maintain a consistent level when changing content or switching to another external input. <ul style="list-style-type: none"> <li>This function is available only when <a href="#">Q-Symphony</a> is set to <a href="#">Off</a>.</li> <li>If <a href="#">Q-Symphony</a> is set to <a href="#">On</a>, This feature is not available.</li> </ul>
<a href="#">Instant Music Play</a>	The music that was playing can be resumed instantly. (For more information, refer to " <a href="#">Using Instant Music Play</a> " section.)
<a href="#">Advanced Sound Settings</a>	<ul style="list-style-type: none"> <li><a href="#">Voice enhancement</a> makes it easier to hear spoken dialog in movies and TV.</li> <li><a href="#">Bass enhancement</a> mode strengthens bass sound.                     <ul style="list-style-type: none"> <li>This feature is supported only on the HW-LS7*H model.</li> </ul> </li> <li><a href="#">Night mode</a> is optimized for night time with the settings adjusted to bring the volume down but keep the dialog clear.</li> <li><a href="#">Virtual</a> : While <a href="#">Adaptive Sound</a> mode is on, it provides extended sound effects when playing Dolby/DTS content.</li> </ul>

## To change your Wi-Fi connection

1. Launch the [Samsung Sound](#) app from your mobile device (smartphone or tablet).
2. Tap the WiFi Speaker's card and tap the (  ) icon.
3. Go to [Device Settings](#) → [Network Status](#) → [Change Wi-Fi network](#), and follow the onscreen instructions.

## Output specifications for the SOUND MODE

### HW-LS7\*H

Effect	Input	Output
Adaptive Sound Music	2.0 ch	3.1.1 ch
	5.0 ch	3.1.1 ch
	Dolby Atmos®	3.1.1 ch
Standard	2.0 ch	3.1 ch
	5.0 ch	3.1 ch
	Dolby Atmos®	3.1.1 ch

### HW-LS5\*H

Effect	Input	Output
Adaptive Sound Music Standard	2.0 ch	2.0 ch
	5.0 ch	2.0 ch
	Dolby Atmos®	2.0 ch

## Using Group Play

- To benefit from this feature, add your WiFi Speaker to the [Samsung Sound](#) app.
- To enable this, connect at least two audio devices to the same Wi-Fi network at 5 GHz.
- This is available on Samsung Sound devices that support Wi-Fi released year 2024 or later.
- This feature does not support TV sound.

### Configuring Group Play

1. Run the [Samsung Sound](#) app on your mobile device.
2. Add the WiFi Speaker in the [Samsung Sound](#) app according to the instructions in the "[Connecting to the Samsung Sound App \(Wireless Network\)](#)" section.
3. Tap the WiFi Speaker's card.
4. On your mobile device, tap [Group Play](#) under the audio device icon.
  - [Group Play](#) button appears only when WiFi Speaker is in Wi-Fi mode.
  - If the WiFi Speaker is playing the TV sound, the connection to the TV is disconnected when creating a group.
5. Enable [Group Play](#).
6. Select a desired device in the list, and tap [Apply](#).
  - You can add a maximum of 4 devices.
  - With [Group Play](#), the audio will be output through the host device alone.
  - When a device connected to the host device switches to a different source, the device will be deleted from the group automatically.
  - When the host device is connected to a TV, the generated group will be deleted automatically.

### Disabling Group Play

1. Tap the audio device's card.
2. On your mobile device, tap [Group Play Settings](#) under the audio device icon.
3. Disable [Group Play](#).
  - To disable an individual device, uncheck the device from the list and tap [Apply](#).

## Connecting to Apple AirPlay

- This feature may not be available in some countries.
- To use **AirPlay** with your Samsung WiFi Speaker, the latest version of iOS, iPadOS, or macOS is recommended.
- To enable **AirPlay** in your WiFi Speaker, you must first register the device with the Samsung **Samsung Sound** app by agreeing with the app's terms and conditions.
- Make sure the WiFi Speaker is powered on and connected to the same Wi-Fi network as your Apple device.

With **AirPlay**, you can enjoy music, podcasts, and other audio on your Samsung WiFi Speaker, right from your Apple devices.

1. Select  from an **AirPlay**-supported app or Control Center on your iPhone, iPad, or Mac.
2. Select the WiFi Speaker from the list of available devices to play the current audio to.

## Connecting by Bluetooth

When a mobile device is connected using Bluetooth, you can hear stereo sound without the hassle of cabling.

- When you connect a paired Bluetooth device with the WiFi Speaker off, the WiFi Speaker automatically turns on.

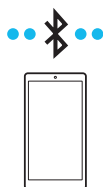

### The initial connection

- When connecting to a new Bluetooth device, make sure the device is within 3.28 ft (1 m) distance.
1. Press **⊘ (Mic On/Off)** button on the WiFi Speaker for 3 seconds or longer.

LED Indicator
[Parting] Red → Green → Blue Blinks
[Connection is complete] Cyan Blinks x 3
 <b>Ready to connect by Bluetooth.</b>

2. On your device, select **Music Studio** from the list that appears.
3. Play music files from the device connected by Bluetooth through the WiFi Speaker.

#### If the device fails to connect

- If you have an existing WiFi Speaker (e.g., "**Music Studio**") in the list of speakers on the Mobile device, delete it.
- Repeat steps 1 and 2.

### Notes on Bluetooth connection

- Locate a new device within 3.28 ft (1 m) to connect by Bluetooth communication.
- If asked for a PIN code when connecting a Bluetooth device, enter <0000>.
- The WiFi Speaker automatically turns off after 18 minutes in the Ready state.
- The WiFi Speaker may not perform Bluetooth search or connection correctly under the following circumstances:
  - If there is a strong electrical field around the WiFi Speaker.
  - If several Bluetooth devices are simultaneously paired with the WiFi Speaker.
  - If the Bluetooth device is turned off, not in place, or malfunctions.

- Electronic devices may cause radio interference. Devices that generate electromagnetic waves must be kept away from the WiFi Speaker main unit - e.g., microwaves, wireless LAN devices, etc.
- The WiFi Speaker supports SBC data (44.1kHz, 48kHz).
- Connect only to a Bluetooth device that supports the A2DP (AV) function.
- You cannot connect the WiFi Speaker to a Bluetooth device that supports only the HF (Hands Free) function.
- When connecting the WiFi Speaker to a Bluetooth device, place them as close to each other as possible.
- The farther the WiFi Speaker and Bluetooth device are from each other, the lower the sound quality will become. The Bluetooth connection may break when the devices are out of the effective range.
- The Bluetooth connection may not function as intended in areas with poor reception.
- A Bluetooth device may experience noise or malfunction under in the following conditions:
  - When the body is in contact with the signal transceiver on the Bluetooth device or WiFi Speaker.
  - In corners or when there is an obstacle in proximity, such as a wall or partition, where electrical changes may occur.
  - When exposed to radio interferences by other products operating on the same frequency ranges, such as medical equipment, microwave ovens, and wireless LAN devices.
  - Obstacles such as doors and walls may still impact the sound quality even when the devices are within the effective range.
- Note that your WiFi Speaker cannot be paired with other Bluetooth devices while using the Bluetooth option.
- This wireless device may cause electrical interference during operation.

### Disconnecting the Bluetooth device from a WiFi Speaker

You can disconnect a Bluetooth device from the WiFi Speaker. For instructions, see the Bluetooth device's user manual.

- The WiFi Speaker will be disconnected.
- If the WiFi Speaker is disconnected from the Bluetooth device, the multicolor LED indicator on the WiFi Speaker blinks "**Red**" three times.

### Disconnecting the WiFi Speaker from the Bluetooth device

Press the **○ (Multi Function)** button on the WiFi Speaker to switch the mode from "**Bluetooth**".

- Disconnecting takes time because the Bluetooth device must receive a response from the WiFi Speaker. (Disconnection time may differ, depending on the Bluetooth device)

## Using Instant Music Play

You can immediately play the last track from your preferred music service app, or play recommended tracks provided by the Spotify app. Press the  button on the Wi-Fi speaker.

- To use this feature, register your Wi-Fi speaker in the [Samsung Sound](#) app. Refer to "[Connecting to the Samsung Sound App \(Wireless Network\)](#)" section.

### Setting up Instant Music Play

You can configure the Wi-Fi speaker to connect directly to the Spotify app or other music service apps.

- Launch the [Samsung Sound](#) app on your mobile device.
- Go to [Samsung Sound](#) → Wi-Fi Speaker (device name) → [Instant Music Play](#), and select the desired option:
  - [Spotify Tap](#): Sets a shortcut to the Spotify app. You must play music once in the Spotify app to complete the shortcut setup.
  - [Play/Pause](#): Sets a shortcut to other music service apps.
- Press the  button on the Wi-Fi speaker to enjoy music playback.

### Playing music instantly with the Button

#### When using the Spotify app

 button press	Operation
Once	Play/Pause
Twice	Plays recommended tracks based on user preferences.

#### When using other music service apps

 button press	Operation
Once	Play/Pause
Twice	Plays the next track

# 06 Connecting to a TV

## Connecting by Wi-Fi

### Pre-connection Checklist

- Wi-Fi connection is available only on Samsung TV.
- Check whether **the wireless router (Wi-Fi)** is turned on and **the TV is connected to the router**.
- The TV and Wi-Fi Speaker must be connected to the same wireless network (Wi-Fi).
- If your wireless router (Wi-Fi) uses a DFS channel, you will not be able to establish a Wi-Fi connection between the TV and Wi-Fi Speaker. Contact your Internet service provider for details.
- Because the menus may differ depending on the year of manufacture, refer to your TV manual.

- For more information about Wi-Fi connection to the Wi-Fi Speaker, refer to "[Connecting to the Samsung Sound App \(Wireless Network\)](#)" section.
- Change the input source of the TV by using the Audio menu to Wi-Fi Speaker.
  - Samsung TVs released in 2017 or later:**  
[Sound](#) → [Sound Output](#) → [Music Studio](#)

## Connecting to a TV that supports Dolby Atmos

### Pre-connection Checklist

- Make sure that the content supports Dolby Atmos®.



LED indicator
White ON → OFF
 <b>Wi-Fi</b>

- Connect the Wi-Fi Speaker and TV to the same wireless network (Wi-Fi).
- For sound output of the TV, select Wi-Fi Speaker.
- TV sound is output from the Wi-Fi Speaker.

### NOTE

- When you use Dolby Atmos®:** If the input source is Dolby Atmos®, refer to "[Output specifications for the SOUND MODE](#)" section.
- Configuring Dolby Atmos® on your BD player or other device connected to the TV.**  
Open the audio output options on the settings menu of your BD player or other device and make sure that "No Encoding" is selected for Bitstream. For example, on a Samsung BD Player, go to Home Menu → Sound → Digital Output and then select Bitstream (unprocessed).
- This function is available in some Samsung TVs and some Wi-Fi Speaker models.
- The image of the Wi-Fi Speaker may be different depending on the model.

## Using the Q-Symphony Function

When the WiFi Speaker connects to a Samsung TV that supports the Q-Symphony function you can play the sound simultaneously through the WiFi Speaker and the TV. If you use the Q-Symphony function, the surround sound played on the TV allows you to enjoy a richer, more three-dimensional surround sound effect.

- It can operate according to the Codec supported by TV.
- This function is supported only when both the WiFi Speaker and the TV are connected to the same Wi-Fi network.
- It is available with Samsung TV models released in 2022 or later.
- The image of the WiFi Speaker may be different depending on the model.

1. Turn on the TV and the WiFi Speaker.
2. In the TV's **Q-Symphony Settings**, select the WiFi Speaker you want to connect.  
(Home (🏠) → Settings (⚙️) → All Settings (⚙️) → Sound → Q-Symphony Settings)
  - When the WiFi Speaker is connected, **Q-Symphony** will appear in the TV's **Sound Output** list. To switch back to the TV speaker, select TV Speaker from the list.  
(Home (🏠) → Settings (⚙️) → All Settings (⚙️) → Sound → Sound Output)



LED indicator
White ON → OFF
🔊 Wi-Fi

## Connecting to Non-Q-Symphony TV

When two WiFi Speakers are connected to a TV that does not support the Q-Symphony feature, you can enjoy stereo sound from the WiFi speakers.

- This feature is supported only on the HW-LS7\*H model.
- It can operate according to the Codec supported by TV.
- Both WiFi Speakers must be connected to the same 5 GHz Wi-Fi network.

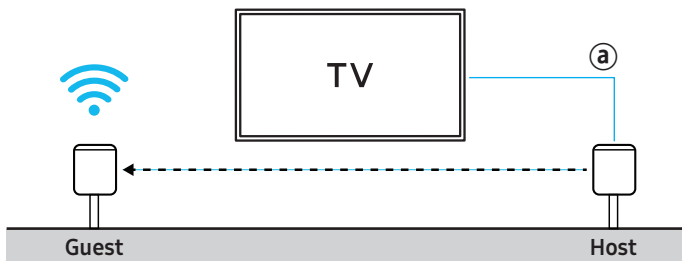

1. Turn on the TV and both WiFi Speakers.
2. On your mobile device, launch the **Samsung Sound** app and tap **Stereo Settings** to activate.  
(Samsung Sound → Music Studio 7 (device name) → Stereo Settings)
3. Connect the TV to the host WiFi Speaker.
  - **a**: You can connect using an optical cable, HDMI cable, or Bluetooth.
  - The WiFi Speaker which is connected to the TV will automatically become the host device.

## Connecting by Bluetooth

When a Samsung TV is connected using Bluetooth, you can hear stereo sound without the hassle of cabling.

- Only one Samsung TV can be connected at a time.
- Samsung TV that supports Bluetooth can be connected. Check the specifications of your TV.



### The initial connection

1. Press **⊘ (Mic On/Off)** button on the WiFi Speaker for 3 seconds or longer.

LED Indicator
[Parting] Red → Green → Blue Blinks [Connection is complete] Cyan Blinks x 3
🔊 Ready to connect by Bluetooth.

- Until pairing is complete, the Multicolor LED changes as **Red → Green → Blue** in turn.
2. Select Bluetooth Speaker List on the Samsung TV.  
(Home (🏠) → Settings (⚙️) → All Settings (⚙️) → Sound → Sound Output → Bluetooth Speaker List)
  3. From the list on the TV screen, select the WiFi speaker (Music Studio) you want to register.  
Once registration is complete, the status will change to **Connected**.
  4. You can now enjoy Samsung TV sound through the WiFi Speaker.  
If you later switch the WiFi Speaker mode to Bluetooth, the TV will automatically reconnect.

### If the device fails to connect

- If you have an existing WiFi Speaker (e.g., **Wi-Fi Speaker**) on the list of speakers on the Samsung TV, delete it.
- Then repeat steps 1 through 3.

## Disconnecting the WiFi Speaker from the Samsung TV

Press the **○ (Multi Function)** button at the side of the WiFi Speaker to select the mode other than "Bluetooth".

- Disconnecting takes time because the Samsung TV must receive a response from the WiFi Speaker. (The time required may differ, depending on the Samsung TV model.)

## Notes on Bluetooth connection

- Locate a new device within 3.28 ft (1 m) to connect by Bluetooth communication.
- If asked for a PIN code when connecting a Bluetooth device, enter <0000>.
- The WiFi Speaker automatically turns off after 18 minutes in the Ready state.
- The WiFi Speaker may not perform Bluetooth search or connection correctly under the following circumstances:
  - If there is a strong electrical field around the WiFi Speaker.
  - If several Bluetooth devices are simultaneously paired with the WiFi Speaker.
  - If the Bluetooth device is turned off, not in place, or malfunctions.
- Electronic devices may cause radio interference. Devices that generate electromagnetic waves must be kept away from the WiFi Speaker main unit - e.g., microwaves, wireless LAN devices, etc.

## Connecting to a TV with HDMI ARC (Audio Return Channel) Support

### CAUTION

- If both an HDMI cable and an optical cable are connected, the HDMI cable signal will take priority.
- When connecting the TV and WiFi Speaker with an HDMI cable, make sure to connect the cable to the ARC port. If the correct port isn't used, the TV won't make any sound.
- Using HDMI cables certified by HDMI.org is recommended.

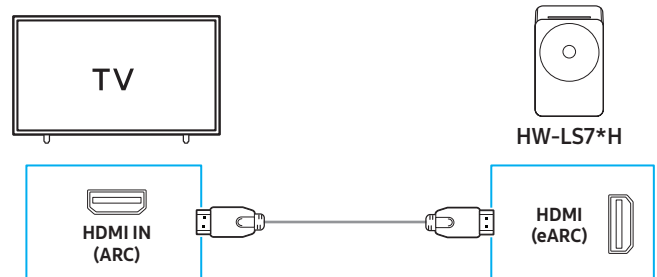

1. While the WiFi Speaker and TV are turned off, connect the HDMI cable as shown in the diagram above.
2. Turn on the WiFi Speaker and TV.
3. TV audio will play through the WiFi Speaker.
  - If there is no TV sound output, press the **○ (Multi Function)** button on the WiFi Speaker to switch to **TV ARC** mode.
  - To connect with eARC, the eARC function in the TV menu should be turned on. Refer to the TV user manual for details about how to configure the settings. (e.g.) Samsung TV: **Home** (🏠) → **Settings** (⚙️) → **All Settings** (⚙️) → **Sound** → **Expert Settings** → **HDMI-eARC Mode (Auto)**
  - If there is no sound output, check the HDMI cable connection status.
  - You can use the volume buttons on your TV remote control to adjust the WiFi Speaker volume.

### NOTE

- This feature is supported only on the HW-LS7\*H model.
- When connecting a TV and soundbar that support HDMI ARC (Audio Return Channel) using an HDMI cable, digital video and audio data can be transmitted without a separate optical cable.
- Using a coreless HDMI cable is recommended whenever possible. If using a cored HDMI cable, ensure its diameter is less than 14 mm.
- This function won't work if the HDMI cable doesn't support ARC.
- If the broadcast audio is encoded in Dolby and the "Digital Output Audio Format" in your TV is set to PCM, changing the settings to Dolby Digital, Dolby Digital+, or Auto is recommended for optimal sound. Changing the setting will provide better sound quality. (The TV menu may use different terms for Dolby Digital and PCM, depending on the manufacturer.)

## Connecting using an Optical Cable

### Pre-connection Checklist

When you use an optical cable and the terminals have covers, be sure to remove the covers.

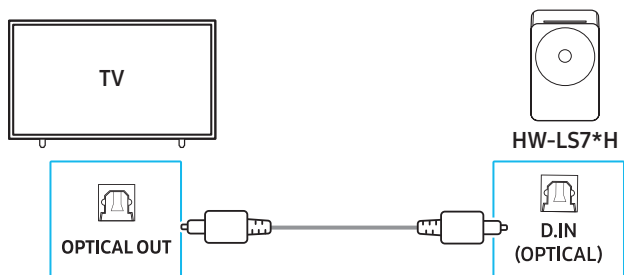

1. With the TV and WiFi Speaker turned off, connect the **D.IN (OPTICAL)** port on the WiFi Speaker and the **OPTICAL** output port on the TV with the optical cable (not supplied), as shown in the figure.
2. Turn on the WiFi Speaker and TV.
3. Press the **○ (Multi Function)** button on the WiFi Speaker unit and then select the **"Digital Audio In"** mode. Then the announcement, **"Digital Audio In"** is output.

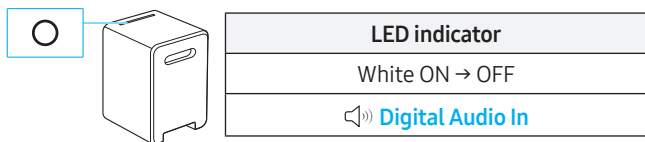

4. The TV sound is output from the WiFi Speaker.

### NOTE

This feature is supported only on the HW-LS7\*H model.

## Using the Spacefit Sound

Provides optimized sound quality by analyzing the listening spaces.

### Connecting via WiFi Speaker

1. Run the **Samsung Sound** app on your mobile device.
2. Tap WiFi Speaker's card.
3. Enable **Spacefit Sound Pro**.
  - This is available in all Sound modes.

### Connecting to TV

To enable this function, turn on the AI Adaptive Sound+ mode on your Samsung TV menu.

(Home (🏠) → Menu → Settings (⚙️) → All Settings (⚙️) → General → Intelligent Mode Settings → AI Adaptive Sound+)

- The sound mode on your WiFi Speaker will automatically change to **Adaptive Sound** if you enable the **AI Adaptive Sound+** mode on your TV.

### NOTE

This function works when the WiFi Speaker connects to some of the Samsung TVs.

# 07 Connecting an External Device

## Connecting using an Optical Cable

### Pre-connection Checklist

Make sure both the external device and the WiFi Speaker are turned off.

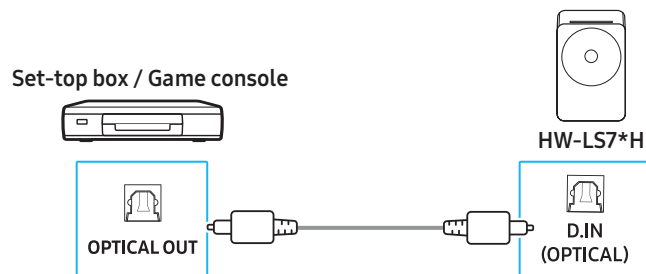

1. Use an optical cable (not supplied) to connect the **D.IN (OPTICAL)** port of the WiFi Speaker and the optical output port of the external device. See the figure below.
2. Turn on both the WiFi Speaker and the external device.
3. Press the **○ (Multi Function)** button on the WiFi Speaker unit and then select the **"Digital Audio In"** mode. Then the announcement, **"Digital Audio In"** is output.

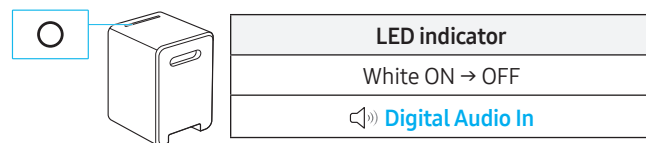

4. The audio signal of the external device will sound from the WiFi Speaker.

### NOTE

This feature is supported only on the HW-LS7\*H model.

## 08 Additional Features

### Installing the WiFi Speaker (HW-LS7\*H) on a Stand

To install the WiFi Speaker on a stand, please purchase a stand separately.

The stand is not sold by Samsung. Refer to the installation guide provided with the purchased stand for proper setup.

- Samsung is not responsible for any product damage caused by improper installation.

#### Screw specifications for mounting the WiFi Speaker on a stand

- Standard screw: 1/4" – 20 UNC (Ø 6.35 mm, pitch 1.27 mm)
- Length: 15 mm
- Quantity: 1

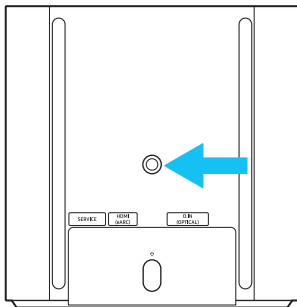

Bottom of the WiFi Speaker

### Activate/Deactivate Wi-Fi and Bluetooth

The WiFi Speaker will restart automatically when the Wi-Fi or Bluetooth function is activated or deactivated.

#### To activate/deactivate Wi-Fi connection

Press and hold the  $\emptyset$  (Mic On/Off) button and the (-) button simultaneously for more than 30 seconds. This will turn on or off the Wi-Fi connection.

#### To activate/deactivate Bluetooth connection

Press and hold the  $\emptyset$  (Mic On/Off) button and the (+) button simultaneously for more than 30 seconds. This will turn on or off the Bluetooth connection.

## 09 Software Update

### Auto Update

When the WiFi Speaker is connected to the Internet, software updates automatically occur even when the WiFi Speaker is turned off.

- To use the Auto Update function, the WiFi Speaker must be connected to the Internet.  
The Wi-Fi connection to the WiFi Speaker will be terminated if the WiFi Speaker's power cord is disconnected or the power is cut off. If the power is cut off, when the power comes back on or you reconnect the power cord, turn on the WiFi Speaker, and then reconnect it to the Internet.

### USB Update

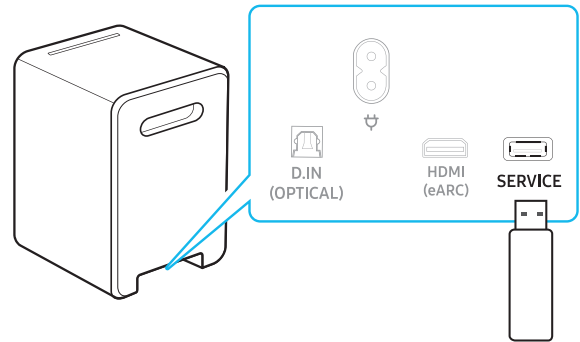

**Samsung may offer updates for the WiFi Speaker's system firmware in the future.**

When an update is available, you can update the WiFi Speaker by connecting the USB drive that contains the update firmware to the SERVICE port of the WiFi Speaker.

1. Go to ([www.samsung.com](http://www.samsung.com)) → search for the model name from the customer support menu option.
  - For more information about update, refer to Upgrade Guide.
2. Download the upgrade file (USB type).
3. Unzip the file to create a folder with the file name.
4. Store the created folder in a USB and then connect it to the WiFi Speaker.
5. Turn on the WiFi Speaker. Then the product is updated within 3 minutes.

LED indicator
The White moves from left to right, then from right to left.

- During update, do not turn it off or remove the USB.
- If the yellow LED is on after the software update is completed, this means that an additional update is in progress. When this happens, don't turn off the power or remove the USB.
- If update does not proceed, reconnect the WiFi Speaker power cord.
- When the latest version is installed, no update is performed.
- Depending on the USB type, update may not be supported.
- If there is no update file available, the indicator blinks red 3 times.
- If the update file is in the same or lower version than the existing, the indicator blinks cyan 3 times.

## Reset

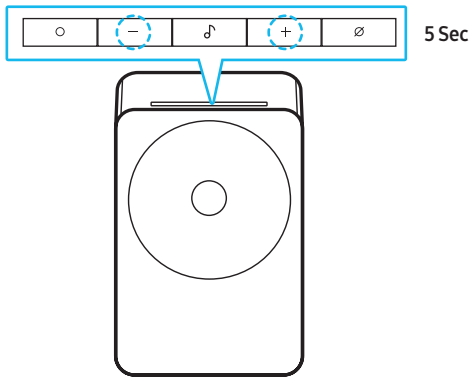

With the WiFi Speaker on, press the **— + (Volume)** buttons on the body at the same time for at least 5 seconds. The LED indicator changes as shown below and then the WiFi Speaker is reset.

LED indicator
White LED indicator moves from left to right and right to left → Cyan Blinks X3 → Red Blinks X3

### ⚠ CAUTION

All the settings of the WiFi Speaker are reset. Be sure to perform this only when a reset is required.

## Security updates information

Security updates are provided to strengthen the security of your device and protect your personal information. For more information on security updates, visit <https://security.samsungtv.com>.

- The website supports only some languages.

# 10 Troubleshooting

Before seeking assistance, check the following.

### WiFi Speaker does not turn on.

- Check whether the power cord of the WiFi Speaker is correctly inserted into the outlet.

### WiFi Speaker works erratically.

- After removing the power cord, insert it again.
- Power cycle the external device and try again.
- If there is no signal, the WiFi Speaker automatically turns off after a certain period of time. Turn on the power.

### The WiFi Speaker indicator turns solid red.

- The microphone is turned off. Turn on the microphone. (For more information, refer to "[Buttons](#)" section.)

### Sound is not output from the WiFi Speaker.

- The volume of the WiFi Speaker is too low or muted. Adjust the volume.
- When any external device (STB, Bluetooth device, mobile device, etc.) is connected, adjust the volume of the external device.
- For sound output of the TV, select WiFi Speaker. (Samsung TV: [Home](#) (🏠) → [Menu](#) → [Settings](#) (⚙) → [All Settings](#) (⚙) → [Sound](#) → [Sound Output](#) → [Select WiFi Speaker](#))
- The cable connection to the WiFi Speaker may not be loose. Remove the cable and connect again.
- Remove the power cord completely, reconnect, and turn the power on.
- Reset the product and try again. (For more information, refer to "[Reset](#)".)

### I want to hear the audio signal from the WiFi Speaker alone.

- If you hear sounds from both the TV and WiFi Speaker, go to the [Settings](#) menu for the TV audio and change the TV speaker to [Music Studio](#).

### WiFi Speaker will not connect by Bluetooth.

- When connecting a new device, switch to "[Bluetooth Pairing](#)" for connection. (Press the [⊗ \(Mic On/Off\)](#) button on the body for at least 3 seconds.)
- If the WiFi Speaker is connected to another device, disconnect that device first to switch the device.
- Reconnect it after removing the Bluetooth speaker list on the device to connect. (Samsung TV: [Home](#) (🏠) → [Menu](#) → [Settings](#) (⚙) → [All Settings](#) (⚙) → [Sound](#) → [Sound Output](#) → [Bluetooth Speaker List](#))
- Remove and reconnect the power plug, then try again.
- Reset the product and try again. (For more information, refer to "[Reset](#)" section.)

### Sound drops out when connected by Bluetooth.

- Some devices can cause radio interference if they are located too close to the WiFi Speaker. e. g. microwaves, wireless routers, etc.
- If your device that is connected by Bluetooth moves too far away from the WiFi Speaker, it may cause the sound to drop out. Move the device closer to the WiFi Speaker.
- If a part of your body is in contact with the Bluetooth transceiver or the product is installed on metal furniture, the sound may drop out. Check the installation environment and conditions for use.

### WiFi Speaker will not connect to Wi-Fi.

- Check whether your wireless router is on.
- Turn off the router, turn it back on, and then try again.
- The WiFi Speaker will not connect if the wireless signal is too weak. Try moving the router closer to the WiFi Speaker, or eliminating any obstacles that are between the WiFi Speaker and the router, if possible.
- If your wireless router is new, you will need to reconfigure the speaker's network settings.

### The WiFi Speaker does not turn on automatically with the TV.

- When you turn off the WiFi Speaker while watching TV, power synchronization with the TV is disabled. First turn off the TV.

### The AVA function is not available in the following cases.

- The AVA function will not be available using **Q-Symphony** function.
- The AVA function will not be available when the microphone is turned off.

### After connecting the TV to the WiFi Speaker, I switched the WiFi Speaker mode. Then no sound is output from the TV.

- If you connect your WiFi Speaker to a mobile device while the WiFi Speaker is connected to the TV, the WiFi Speaker outputs sound from the mobile device while keeping the TV connection. So the TV sound will not be delivered anywhere.
- Disconnect the mobile device, and the TV sound will be output from the WiFi Speaker again.

### Group Play is not enabled

- Check if the audio devices are newer models released year 2024 or later.
- Check if the host device is connected to a Wi-Fi network as source.
- Make sure that all audio devices are connected to the same Wi-Fi network (at 5 GHz).

## 11 License



Dolby, Dolby Atmos, and the double-D symbol are registered trademarks of Dolby Laboratories Licensing Corporation. Manufactured under license from Dolby Laboratories. Confidential unpublished works.

Copyright © 2012-2026 Dolby Laboratories. All rights reserved.



Apple, AirPlay, iPad, iPhone, and Mac are trademarks of Apple Inc., registered in the U.S. and other countries and regions.



- Use your phone, tablet or computer as a remote control for Spotify. Go to [spotify.com/connect](https://spotify.com/connect) to learn how
- The Spotify Software is subject to third party licenses found here: <https://www.spotify.com/connect/third-party-licenses>



Being Roon Tested means that Samsung and Roon have collaborated to ensure you have the best experience using Roon software and Samsung equipment together, so you can just enjoy the music.

[HW-LS7\*H]



The terms HDMI, HDMI High-Definition Multimedia Interface, HDMI Trade dress and the HDMI Logos are trademarks or registered trademarks of HDMI Licensing Administrator, Inc.

### Open Source License Notice

Open Source used in this product can be found on the following webpage (<http://opensource.samsung.com>).