

# Operating instructions

Adora SL

Washing machine

# Safety precautions



Read the operating instructions before using the appliance for the first time.

## General safety precautions

- This appliance can be used by children aged 8 and above and by persons with reduced physical, sensory or mental capabilities, or lack of experience and/or knowledge, provided they are supervised or have been instructed on the safe use of the appliance and have understood the hazards involved. Children must not play with the appliance. Cleaning and user maintenance shall not be undertaken by children without supervision.
- If an appliance is not equipped with a mains cable and a plug or other means for disconnecting from the mains with a contact opening on each pole complying with the conditions of overvoltage category III for full isolation, an isolating device must be incorporated into the permanently installed electrical installation in accordance with the installation regulations.

- If the mains cable of this appliance is damaged, it must be replaced by the manufacturer or its Customer Services or a similarly qualified person in order to avoid hazard.

## Appliance-specific safety precautions

- Children under 3 years of age must be kept away from the appliance unless they are constantly supervised.
- The appliance has a maximum dry load capacity of 8 kg.

### CAUTION

- If this appliance is supplied from a cord extension set or electrical portable outlet device, the cord extension set or electrical portable outlet device must be positioned so that it is not subject to splashing or ingress of moisture.

## Instructions for use

- If connected to the water mains by detachable hoses, the new hose set supplied with the appliance must be used. Do not reuse old hose sets.
- Ensure ready access to the power socket being used.

- Any repairs, modifications or manipulations to the appliance, especially any electrically live parts, may only be carried out by the manufacturer, its customer service department or similarly qualified persons. Repairs if carried out incorrectly may cause serious injury, damage to the appliance and fittings, as well as affect the functioning of the appliance. If the appliance is not working properly or in case a repair is needed, follow the instructions given in the «Service and repairs» section. Please contact our Customer Services if necessary.
- Before closing the appliance door and starting a programme, ensure that there are no foreign objects or pets in the drum.
- Strictly use original spare parts only.
- If the appliance is not functioning properly, disconnect it from the power supply immediately.
- Packaging material, e.g. plastic film and polystyrene, can be dangerous for children. Danger of suffocation! Keep packaging material away from children.
- To protect your washing, follow the fabric care symbols and the hints and advice in the «Washing tips» section.
- Textiles that have been cleaned, treated or soaked with flammable chemicals, detergents or solvents such as benzene, alcohol, stain remover, oil, paint, wax, etc. are not to be washed in the appliance. Fire or explosion hazard! Wash materials containing such substances first by hand with water or allow the solvent to evaporate completely.
- Ensure the washing drum has stopped moving before reaching inside. Do not touch the washing drum while it is still in motion – risk of serious injury!
- Disconnect the appliance from the mains before carrying out maintenance work.

## Correct use

The appliance is only suitable for washing home textiles with water and regular washing machine detergent. It is designed for use in the home and for the above-mentioned purpose only. No liability is assumed for any damage caused by improper or incorrect use.

## How to avoid damaging the appliance

- Close the appliance door carefully.
- Before closing the appliance door and starting a programme, ensure that there are no foreign objects or pets in the washing drum, detergent dispenser drawer or around the foreign body trap. Foreign objects such as coins, nails, paper clips, etc. can damage parts of the appliance as well as the washing.
- During longer periods of absence, turn off the water tap before switching off the power by pulling out the mains plug. Never pull the mains plug out by the cable. Please note: The built-in overflow protection is rendered inactive when the power is switched off.
- When cleaning the appliance make sure no water gets inside it. Use a moderately damp cloth. Do not spray the outside or the inside of the appliance with water. If water gets inside the appliance, it will cause damage.
- Textiles with metal reinforcements are not to be washed in the appliance. Risk of damage.
- Trainers, diving suits, rucksacks, carpets, etc. are not to be washed in the appliance.

## Using for the first time

 The appliance must be installed and connected to the electricity supply by a qualified fitter/electrician in accordance with the separate installation instructions.

## Transport lock

 Remove the transport lock (hexagon head screws at the back of the appliance) in order to avoid damage to the appliance (see installation instructions).

## Running the first wash cycle without any washing

- ▶ Add a little washing detergent to compartment II.
- ▶ Run an empty coloureds 60 °C cycle to remove any residues from the manufacturing process.

## Serial number

The serial number (FN) is located on the identification plate:

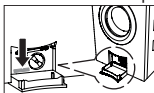

- ▶ Note down the FN on the back page of these operating instructions.

The FN can also be retrieved as follows:

- ▶ Hold the  button depressed until the following display appears:



## Note on the operating instructions

For more information on your appliance and for answers to frequently asked questions, visit <http://www.vzug.com>.

## Symbols used

 Denotes important safety precautions.

Failure to observe said precautions can result in injury or in damage to the appliance or fittings!

## Validity

The product family (model number) corresponds to the first alphanumeric on the identification plate. These operating instructions apply to:

<b>Appliance designation</b>	Adora SL
<b>Type</b>	WAASLZ
<b>Product family</b>	11012

Variations depending on the model are noted in the text.

## Modifications

Text, diagrams and data correspond to the technical standard of the appliance at the time these operating instructions went to press. The right to make technical modifications for the purpose of the further development of the appliances is reserved.

# Contents

<b>1 Appliance description</b>	<b>6</b>	<b>5 User settings</b>	<b>23</b>
1.1 Appliance construction .....	6	<b>6 Care and maintenance</b>	<b>27</b>
1.2 Indicator lights .....	6	6.1 Cleaning the detergent dispenser drawer (as required) .....	27
1.3 Operating and display elements .....	7	6.2 Cleaning the water inlet filter .....	28
<b>2 Programme overview</b>	<b>8</b>	6.3 Emergency draining .....	28
2.1 Whites and coloureds programmes.....	8	6.4 Cleaning the foreign body trap .....	29
2.2 Programmes for normally soiled cotton load 8		6.5 Opening the appliance door in the event of a power failure.....	30
2.3 Extra programmes .....	9	<b>7 Trouble-shooting</b>	<b>31</b>
2.4 Additional functions .....	9	7.1 Error messages.....	31
2.5 EcoManagement .....	11	7.2 Other possible problems.....	33
<b>3 Operating the appliance</b>	<b>12</b>	7.3 Unsatisfactory wash results .....	35
3.1 Preparations.....	12	<b>8 Spare parts</b>	<b>37</b>
3.2 Loading the washing .....	12	<b>9 Technical data</b>	<b>38</b>
3.3 Adding washing detergent .....	13	9.1 Note for testing institutes .....	38
3.4 Detergent dosage .....	14	9.2 Consumption values.....	39
3.5 Dyeing textiles .....	14	9.3 VAS Vibration Absorbing System .....	39
3.6 Selecting programme.....	14	9.4 Water and energy economy .....	39
3.7 Programmes for normally soiled cotton load 15		9.5 Automatic energy-saving stand-by .....	40
3.8 Selecting additional functions.....	15	<b>10 Washing tips</b>	<b>40</b>
3.9 Delayed start.....	15	10.1 Energy and water economy.....	40
3.10 OptiTime .....	16	10.2 Avoiding damage.....	41
3.11 Separate rinsing / Separate spinning.....	16	<b>11 Disposal</b>	<b>42</b>
3.12 Soaking.....	16	<b>12 Notes</b>	<b>43</b>
3.13 Bio wash / Soap wash.....	17	<b>13 Quick instructions</b>	<b>44</b>
3.14 Correcting entry.....	17	<b>14 Services &amp; support</b>	<b>44</b>
3.15 Aborting a programme .....	17		
3.16 With childproof lock activated .....	18		
3.17 Opening the appliance door during washing 18			
3.18 End of programme .....	19		
3.19 EcoManagement statistics .....	20		
<b>4 Favourites</b>	<b>21</b>		
4.1 Defining favourites .....	21		
4.2 Changing favourites .....	21		
4.3 Deleting favourites .....	22		
4.4 Starting favourites .....	22		

# 1 Appliance description

## 1.1 Appliance construction

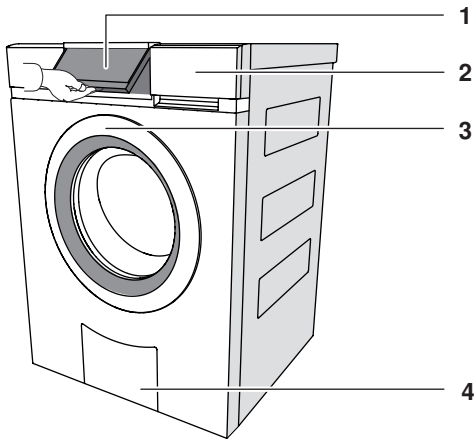

### Detergent dispenser drawer (2)

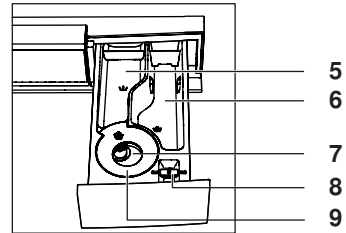

### Drain tray (4)

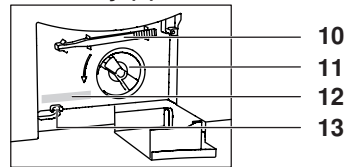

- |   |   |    |   |
|---|---|----|---|
| 1 | Pivoting operating panel  | 8  | Liquid detergent flap / drain tray opener |
| 2 | Detergent dispenser drawer  | 9  | Siphon for fabric conditioner             |
| 3 | Appliance door  | 10 | Emergency door release tool               |
| 4 | Drain tray  | 11 | Foreign body trap                         |
| 5 | Pre-wash detergent, compartment I   | 12 | Identification plate / serial number (FN) |
| 6 | Main wash detergent, compartment II   | 13 | Emergency door release                    |
| 7 | Fabric conditioner, compartment  |    |   |

## 1.2 Indicator lights



**Illuminated:** relevant function active



**Off:** relevant function not selectable



**Flashing:** relevant function selectable

## 1.3 Operating and display elements

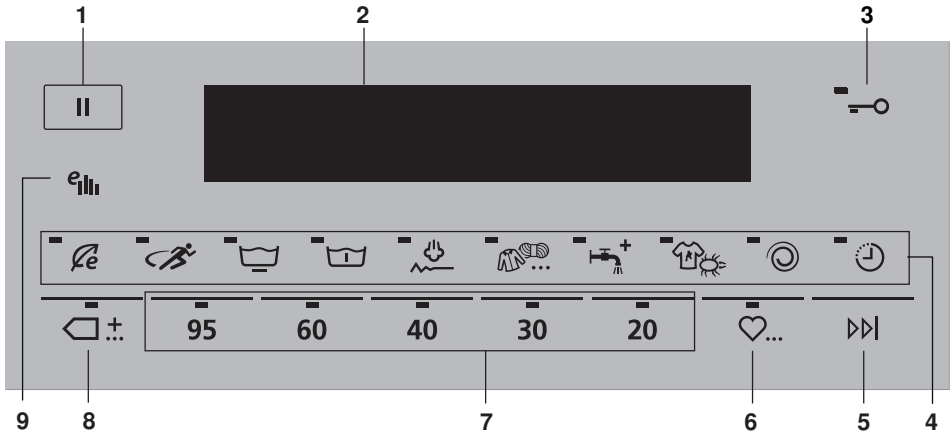

- |  |  |
|--|--|
| <b>1</b> Pause                           | <b>6</b> Favourites  |
| <b>2</b> Display                         | <b>7</b> Whites and coloureds programmes                                 |
| <b>3</b> Door opener                     | <b>8</b> Programmes for normally soiled cotton load and extra programmes |
| <b>4</b> Additional functions            | <b>9</b> EcoManagement   |
| <b>5</b> Fast forward / End of programme |  |

### Whites and coloureds programmes

- 95** Whites 95 °C
- 60** Coloureds 60 °C
- 40** Coloureds 40 °C
- 30** Coloureds 30 °C
- 20** Coloureds 20 °C
- Coloureds 10 °C



### Programmes for normally soiled cotton load and extra programmes

- 40 °C Coloureds normal
- 10 °C Coloureds normal
- Steam anti-crease
- Proofing
- Appliance hygiene



























### Additional functions

- Eco
- Sprint
- Easy care
- Pre-wash
- Steam anti-crease
- Fabric types
- AquaPlus
- Degree of soiling, Anti-mite
- Spin speed
- Delayed start incl. OptiTime



## 2 Programme overview

To select the right programme, please follow the fabric care symbols on the laundry labels, e.g. . woollens and textiles with the  fabric care label may only be washed using the additional function «Hand wash».





### 2.1 Whites and coloureds programmes

Buttons	Programmes	Fabric care symbols	Load capacity
1x 	<b>Whites 95 °C:</b> For white cottons/linens e.g. bed and table linen, towels, white or colour-fast underwear.		<b>1–8 kg</b>
2x 	<b>Coloureds 70 °C:</b> Energy-saving programme for white cottons.		<b>1–8 kg</b>
	<b>Coloureds 60 °C:</b> For coloured cottons e.g. bright blouses, overalls, shirts, bed linen.	 , 	<b>1–8 kg</b>
	<b>Coloureds 40 °C:</b> For coloured cottons and mixed washing e.g. coloured sweatshirts, t-shirts.	 ,  , 	<b>1–8 kg</b>
	<b>Coloureds 30 °C:</b> For coloured cottons and mixed washing e.g. t-shirts.	 ,  ,  , 	<b>1–8 kg</b>
1x 	<b>Coloureds 20 °C:</b> Energy-saving programme for lightly soiled textiles.	 ,  ,  , 	<b>1–8 kg</b>
2x 	<b>Coloureds 10 °C:</b> Refresh programme without heat, suitable for washing new clothes for the first time.	 ,  ,  , 	<b>1–8 kg</b>









### 2.2 Programmes for normally soiled cotton load











Buttons	Programmes	Load capacity
1x 	<b>40 °C Coloureds normal:</b> The recommended programme for washing normally soiled cottons at rated load capacity.	<b>1–8 kg</b>
2x 	<b>10 °C Coloureds normal:</b> The programme with the lowest possible temperature setting for washing cottons. It corresponds to the 40 °C Coloureds normal programme without the water being heated. This programme has the same water level as the 40 °C Coloureds normal programme.	<b>1–8 kg</b>













## 2.3 Extra programmes

Buttons	Programmes	Fabric care symbols	Load capacity
3x 	<b>Steam anti-crease:</b> Dry washing is increased and made damp, ready to iron.		<b>1–1.5 kg</b>
4x 	<b>Proofing:</b> For starching or proofing laundry, add the agent to the fabric conditioner compartment.		<b>1–3 kg</b>
5x 	<b>Appliance hygiene:</b> Steam cleaning without laundry.		<b>0 kg</b>

## 2.4 Additional functions

Buttons	Additional functions	Load capacity
	<b>Eco:</b> Large energy savings due to reduced wash temperature. The extended washing time ensures the washing performance is maintained. Depending on programme, energy savings of about 10%-40%, extension of the washing times by 25–60 minutes and water savings of about 10%-20%.	
	<b>Sprint:</b> Short programme for lightly soiled washing. 2 instead of 3 rinsing cycles.	<b>2.5 kg</b>
	<b>20</b> +  : 26 mins. <b>40</b> +  : 28 mins.	
	<b>30</b> +  : 27 mins. <b>60</b> +  : 39 mins.	
	<b>Note:</b> Add a small quantity of washing detergent. A large washing load or too much washing detergent can significantly extend the programme time. Use liquid detergent only.	
	<b>Easy care:</b> For washing requiring very gentle treatment. Increased water level, reduced washing action and lower spin speed.	<b>3.5 kg</b>
	<b>Pre-wash:</b> Suitable for heavily soiled washing. Programme duration extended about 15 minutes.	
	<b>Steam anti-crease:</b> Reduces creasing significantly. Loosening-up time: 60 minutes. The washing is warm and should be hung up immediately to dry or be tumble dried. The spin speed is limited to 1000 rpm.	<b>max. 2 kg</b>

Buttons	Additional functions	Load capacity
	<b>Fabric types:</b> Press the button repeatedly to select the fabric type.	
	<b>Coloureds:</b> Standard programme	<b>1–8 kg</b>
	<b>Woolens:</b> Gentle treatment for woolens and other delicate textiles. Only for woolens with a felt-free finish and labelled as «machine washable».	<b>1–2 kg</b>
	<b>Hand wash:</b> Very gentle treatment for textiles labelled with the  fabric care symbol.	<b>1–2 kg</b>
	<b>Shirts:</b> Optimized for minimizing creasing, contains steam anti-crease.	<b>max. 7 items</b>
	<b>Outdoor garments:</b> For waterproof and breathable clothing. Higher water level during washing and spinning.	<b>max. 3 kg</b>
	<b>Net curtains:</b> Reduced washing action for very gentle treatment. Higher water level during washing and spinning. The washing remains lying in the water after the final rinse (stop after rinsing).	<b>max. 2 kg</b>
	+ 1x  Draining with spinning	
	+ 2x  Draining without spinning	
	<b>Black garments:</b> Optimized rinsing through a higher water level and extended rinsing time for dark textiles.	<b>max. 4 kg</b>
	<b>Denim:</b> Optimized for colour run from denim.	<b>max. 4 kg</b>
	<b>Baby garments:</b> Very thorough rinsing for the protection of sensitive baby skin. If 95 °C is selected as the temperature, a pre-wash is included.	<b>max. 5 kg</b>
	<b>Down:</b> Optimized for the particular wetting characteristics of down fabrics. Short spin at the beginning of the programme to get rid of any air in down textiles.	<b>max. 2 kg</b>
	<b>Silks:</b> For delicate silk articles. Spin speed is reduced to minimize creasing.	<b>max. 1.5 kg</b>
	<b>AquaPlus:</b> There are 5 different settings for rinsing intensity.	
1x 	<b>Standard:</b> Normal water level.	
2x 	<b>more water:</b> Increased water level during the main wash and rinsing.	
3x 	<b>+ 1 rinse:</b> An additional rinsing cycle.	
4x 	<b>more water + 1 rinse:</b> Increased water level during the main wash and rinsing, an additional rinsing cycle.	
5x 	<b>Skin protection:</b> Increased water level during rinsing, two additional rinsing cycles. Suitable for sensitive skin.	

Buttons	Additional functions
	<b>Degree of soiling / Anti-mite:</b> Adjustment to the degree of soiling of the washing.
<b>1x</b> 	<b>Light soiling:</b> For lightly soiled washing.
<b>2x</b> 	<b>Medium soiling:</b> For normally soiled washing. Extended wash time.
<b>3x</b> 	<b>Heavy soiling:</b> For heavily soiled washing. Extended wash time, higher water level, an additional rinsing cycle.
<b>4x</b> 	<b>Anti-mite:</b> The main wash is intensified. Suitable for individuals with an allergy to mites.
<b>5x</b> 	<b>Soaking:</b> The duration can be set between 0.5 and 6 hours.
	<b>Spin speed:</b> The spin speed can be changed. Delicates can be spun at a lower spin speed. The lower the spin speed, the longer the drying time.
	<b>Delayed start:</b> For using cheap-rate electricity (setting range of up to 24 hours). The programme starts automatically when the set time is reached.
	<b>OptiTime:</b> If a programme end time has been selected, OptiTime calculates the most energy-efficient programme that can be carried out in the time remaining to programme end. OptiTime reduces the washing temperature, while the washing performance is maintained. The more time is available for washing, the more the washing temperature can be reduced. If higher wash temperatures with a germ-killing effect are needed, a corresponding programme without the OptiTime function must be selected.
	<b>Separate rinsing / Separate spinning:</b> The programme starts at the desired parts of the programme and the programme sequence is shortened (see page 16).
	<b>Bio wash</b> (alkaline detergent + bleach) / <b>Soap wash</b> (water softener + soap detergent): The programme sequence is adapted for the use of multi-component detergents (see page 17).
	Pressing the button interrupts the programme running. Pressing it again resumes the programme.

## 2.5 EcoManagement

 EcoManagement provides information on the energy and water consumption of the appliance. The following statistical data can only be retrieved when no programme is running:

- Energy and water consumption of the last programme
- Total energy and water consumption
- Average energy and water consumption of the last 25 programmes

The energy and water consumption of a programme is displayed during programme selection. At the end of a programme, the energy and water consumption of the last programme run is displayed.

## 3 Operating the appliance

### 3.1 Preparations

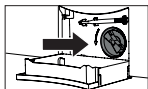

▶ Check the foreign body trap is inserted correctly.

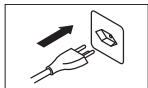

▶ Insert the mains plug into a suitable mains socket.



▶ Turn on water tap.

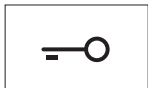

▶ Press the button to open the appliance door.

### 3.2 Loading the washing

▶ Load up to a maximum of 8 kg dry washing.



full:

Normally soiled whites and coloureds



max.  $\frac{3}{4}$ :

Heavily soiled whites and coloureds



max.  $\frac{1}{2}$ :

Easy care cottons, white and coloured synthetics as well as mixed fabrics



max.  $\frac{1}{4}$ :

Delicates, woollens, silks, polyacrylics and net curtains

**Note:** For wet loads, only half-fill the washing drum. The washing drum should not be loaded with any one single, heavy item.



▶ Close the appliance door firmly.

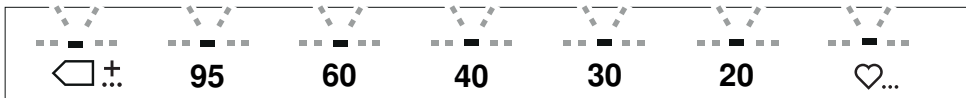

The indicator lights for the programme buttons flash. They go out after 20 seconds if no programme selection is made. A programme can still be selected afterwards.

### 3.3 Adding washing detergent

#### Liquid detergent

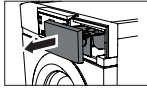

- ▶ Pull the detergent dispenser drawer out as far as it will go.

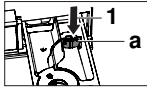

- ▶ Pull flap **a** upwards and out and insert into position **1**.

#### Powder detergent

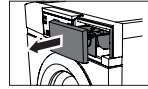

- ▶ Pull the detergent dispenser drawer out as far as it will go.

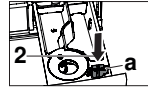

- ▶ Pull flap **a** upwards and out and insert into position **2**.

#### Note: Liquid detergent

- Do not fill past the upper mark.
- Only use for main wash with programmes without a pre-wash.
- Only use for temperatures of up to 60 °C.
- If washing with a delayed start, add to a dosing aid (e.g. ball) and place it directly in the washing drum so that no detergent gets onto the washing during the delayed start time.

### Compartments

#### Conventional washing

Pre-wash detergent

Compartment I

Main wash detergent

Compartment II

Fabric conditioner

Compartment 

#### Bio wash

Alkaline detergent

Compartment II

Bleach

Compartment I

Fabric conditioner

Compartment 

#### Soap wash

Water softener

Compartment I

Soap detergent

Compartment II

Fabric conditioner

Compartment 

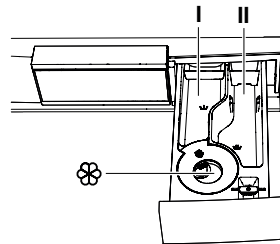

#### Note: Fabric conditioner

- Do not fill past the upper mark.
- Where possible do not use if tumble drying, as tumble drying automatically leaves fabrics soft and fluffy to the touch.

### 3.4 Detergent dosage



Adding too much washing detergent can cause excess foaming, The consequences: poor wash results, damage to the appliance in the worst case.

The correct dosage depends on the degree of soiling, the wash load, the water hardness and the product used. Follow the manufacturer's dosing instructions.

#### Water hardness

**Soft** 0 °fH to 15 °fH

**Medium** 15 °fH to 25 °fH

**Hard** over 25 °fH

The local water authorities can provide information on the level of water hardness in your area.

#### After adding the washing detergent

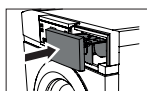

- ▶ Push the detergent dispenser drawer back in.
- ▶ Select a programme.

### 3.5 Dyeing textiles

Textiles can be dyed in the appliance using suitable dyeing agents. Follow the manufacturer's safety instructions and warnings.

**Note:** Each wash programme starts with brief draining. Add liquid dye components after this.

### 3.6 Selecting programme

60

- ▶ Press the button for the desired programme once or more.  
The programme selected, the expected duration and the expected programme end time are displayed.



The indicator lights for selectable additional functions flash.

## 3.7 Programmes for normally soiled cotton load

### 40 °C Coloureds normal



- ▶ Press the button 1x.  
The adjacent display appears.

40°C Coloureds normal	3h40
1400 rpm	End 13:49

### 10 °C Coloureds normal



- ▶ Press the button 2x.  
The adjacent display appears.

10°C Coloureds normal	3h40
1400 rpm	End 13:49

## 3.8 Selecting additional functions



- ▶ Press the button for the desired programme once or more.



- ▶ Press the button for the desired programme once or more.  
If the programme needs to be changed, it is possible to select a new programme within 20 seconds. Additional functions must also be reselected. If no button is pressed within the next 20 seconds, the programme selected starts automatically.

## 3.9 Delayed start

### Selecting programme end time

The options «Programme end time» and «OptiTime OFF» must be enabled in the user settings under «Programming delayed start / OptiTime».



- ▶ Press the button for the desired programme once or more.



- ▶ Press the button repeatedly until the desired programme end time appears in the display.

The display goes dark. The desired programme starts automatically when the set time is reached.



- ▶ To reduce the remaining time delay in hourly intervals, press the button repeatedly again.

Laundry can be added at any time.

### Selecting programme start time

The option «Programme start time» must be enabled in the user settings under «Programming delayed start».

- ▶ Carry out steps analogous to those described in «Selecting programme end time».

### 3.10 OptiTime

The options «Programme end time» and «OptiTime ON» must be enabled in the user settings under «Programming delayed start / OptiTime».



- ▶ Press the button for the desired programme once or more.



- ▶ Press the button.  
The additional function «OptiTime» appears.



- ▶ Press the button repeatedly until the desired programme end time appears.  
The delayed start time starts with the additional function «OptiTime».



- ▶ If «OptiTime» or «Eco» must be switched off, press the button repeatedly until the desired programme appears.

### 3.11 Separate rinsing / Separate spinning



- ▶ Press the button for the desired programme.



- ▶ Press the button 1x.  
Programme starts from «Rinsing» and «Spinning».
- ▶ Press the button 2x.  
Programme starts from «Final rinse / Conditioning» and «Final spin».
- ▶ Press the button 3x.  
Programme starts from «Separate spinning».

### 3.12 Soaking



- ▶ Press the button for the desired programme once or more.



- ▶ Press the button 5x.



- ▶ Press the button repeatedly until the desired duration is set.

### 3.13 Bio wash / Soap wash

Ensure the alkaline detergent or soap detergent are added to the correct compartment (see page 13).

#### Bio wash



- ▶ Press the button for the desired programme once or more.



- ▶ Press the button 2x.

#### Soap wash



- ▶ Press the button for the desired programme once or more.



- ▶ Press the button 3x.

### 3.14 Correcting entry



- ▶ Press another programme button during programme selection. All entries are cleared.

### 3.15 Aborting a programme

**Note:** Once a programme has started, only the spin speed can be changed. For any other changes, the programme must be aborted.



- ▶ Touch the button repeatedly until «Draining» appears in the display. This part of the programme cannot be skipped and will be carried out in full.

## 3.16 With childproof lock activated

### Selecting programme

How to turn the childproof lock on/off is described in «User settings».



- ▶ Close the appliance door.  
The adjacent display appears.

Childproof lock

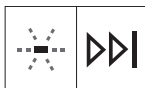

- ▶ Hold the desired, flashing programme button depressed and at the same time press the «Fast forward / End of programme» button.  
The indicator lights for the additional functions flash.

### Aborting programme

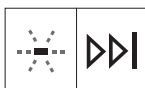

- ▶ Hold the flashing programme button depressed.
- ▶ At the same time press the «Fast forward / End of programme» button repeatedly until the adjacent display appears.

Draining

0h01  
end 15:38

The «Draining» part of the programme cannot be skipped and will be carried out in full.

## 3.17 Opening the appliance door during washing

The appliance door can only be opened if the indicator light for the  button is illuminated.

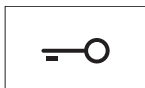

- ▶ Touch the button.  
The appliance door opens. Laundry can be added or removed.



- ▶ Close the appliance door.  
The programme is resumed.

**Note:** In the event of a power failure, the appliance door can only be opened using the emergency door release (see page 30). The programme sequence is automatically resumed following such a power failure.

## 3.18 End of programme

### Unloading the washing before time

Shortly before the end of the programme, the washing is loosened up. This takes about 1–2 minutes.

**Note:** If steam anti-crease has been selected, the loosening-up period is extended to about 60 minutes to further prevent creasing.

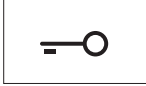

- ▶ Press the button to unload the washing during the loosening-up phase.

### Door opener

The user settings that are enabled determine whether the appliance door opens automatically when the programme ends and whether information on energy consumption is displayed or not.

#### «Automatic door opener ON»

The appliance door opens automatically at the end of the programme and the washing can be unloaded.

#### «Automatic door opener OFF» and «EcoManagement OFF»

When the programme has finished, the following display appears for about 20 minutes:

End of programme

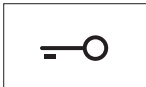

- ▶ Press the button to open the appliance door and unload the washing.

#### «Automatic door opener OFF» and «EcoManagement ON»

When the programme has finished, the following display appears for about 20 minutes:

End of programme  
⚡ 0.6kWh 53ℓ

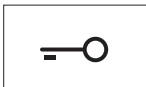

- ▶ Press the button to open the appliance door and unload the washing.

### Stop after rinsing

The washing remains lying in the water after the final rinse. The water must be drained off before the washing can be unloaded.

#### Draining with spinning



- ▶ Touch the button 1x.

#### Draining without spinning



- ▶ Touch the button 2x.

### Hygiene recommendation

- If the adjacent display appears at the end of the programme:
  - ▶ Run the next wash cycle at least at 60 °C.
- If the adjacent display appears at the end of the programme:

Hygiene recommendation:  
at least 60 °C programme

or select appliance  
hygiene



- ▶ Unload the washing.
- ▶ Close the appliance door.



- ▶ Press the button 5x.  
The «Appliance hygiene» programme starts.

### Each time after use



- ▶ Clean the detergent dispenser drawer.
- ▶ Pull the detergent dispenser drawer out as far as it will go in order for it to dry.
- ▶ Remove any deposits or foreign objects from out of the door seal.
- ▶ Leave the appliance door slightly ajar to allow the washing drum and door seal to dry.

## 3.19 EcoManagement statistics

Energy and water consumption can be displayed before a programme starts or after a programme ends.

### Display total consumption



- ▶ Hold the button depressed for 3 seconds.  
The adjacent display appears.

Total consumption  
⚡ 205kWh 4672ℓ

### Display average consumption



- ▶ Press the button again.  
The adjacent display appears.

Average per cycle  
⚡ 1.3kWh 65ℓ

## 4 Favourites

Simple start to frequently used programmes.

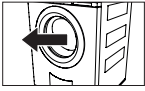

**Note:** The appliance door has to be open to define, change or delete a favourite.

### 4.1 Defining favourites



- ▶ Press the button 2x.  
The adjacent display appears.



- ▶ Select programme and additional functions.



- ▶ Press the button.  
The adjacent display appears.

- ▶ Press one of the two adjacent buttons.

Define favourite  
♥1 empty 15:38

♥1 save changes?  
YES: ↓ NO: ↓



Save favourite programme.



Cancel action.

### 4.2 Changing favourites



- ▶ Press the button repeatedly until the favourite programme to be changed appears.

- ▶ Make changes.



- ▶ Press the button.  
The adjacent display appears.

- ▶ Press one of the two adjacent buttons.

60 °C Coloureds 1h15  
♥1

♥1 save changes?  
YES: ↓ NO: ↓



Save changes.



Cancel action.

### 4.3 Deleting favourites



- ▶ Press the button repeatedly until the favourite programme to be cleared appears:  
The adjacent display appears.



- ▶ Hold the button depressed for about 3 seconds.  
The adjacent display appears.

- ▶ Press one of the two adjacent buttons.

Define favourite  
♥1 empty 15:38

♥1 save changes?  
YES: ↓ NO: ↓



Clear favourite programme.



Cancel action.

### 4.4 Starting favourites



- ▶ Close the appliance door.



- ▶ Press the button repeatedly until the desired favourite programme appears:  
The favourite programme starts automatically after 20 seconds.

60 °C Coloureds 1h15  
♥1

## 5 User settings

Providing no programme is running and no error message is displayed, the user settings can be changed with the appliance door open or closed.

### 5.1 Preparations

The serial number has to be retrieved before the user settings can be changed.



- ▶ Hold the button depressed until the adjacent display appears. The user settings can be changed.

### 5.2 Language



The language is set during the initial set-up of the appliance. It can be changed.

### 5.3 Time

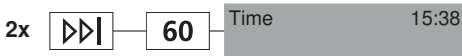

The time must be reset after a power failure lasting around 5 weeks. The appliance must not be disconnected from the mains supply for at least 30 minutes after making the settings.

### 5.4 Spin speed

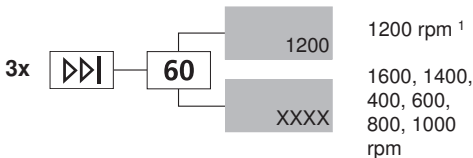

An increase in the spin speed is only possible for suitable programmes. A reduction in the spin speed is possible for all programmes.

<sup>1</sup> Factory setting

## 5.5 EcoManagement

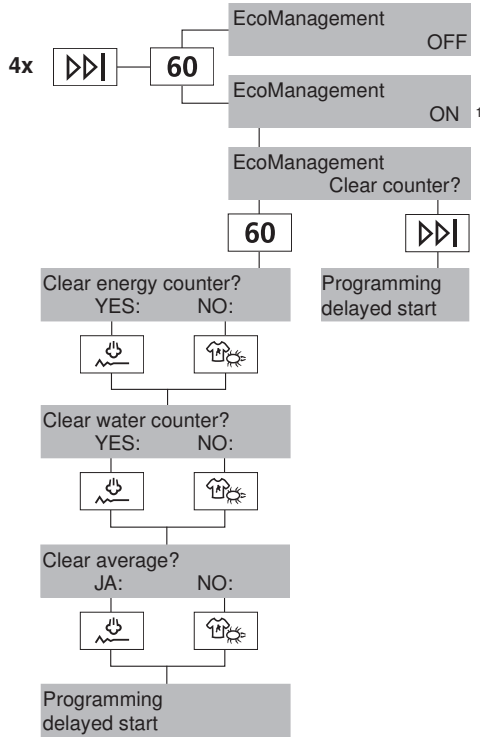

When this function is activated, expected consumption values appear at the start of the programme and actual consumption values appear at the end of the programme. The stored consumption values can be deleted as well.

## 5.6 Programming delayed start/OptiTime

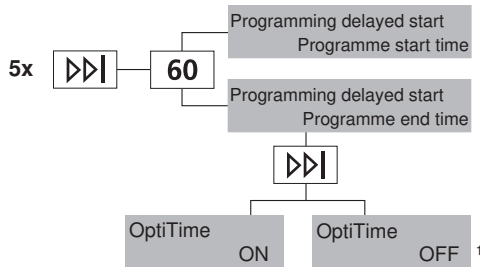

When the «Programme start» function is turned on, the time a programme should start running can be defined. When the «Programme end» function is turned on, the time a programme should end can be defined. If the «OptiTime» function is also turned on, the «OptiTime» function is automatically added whenever a delayed start is selected.

<sup>1</sup> Factory setting

## 5.7 AquaPlus

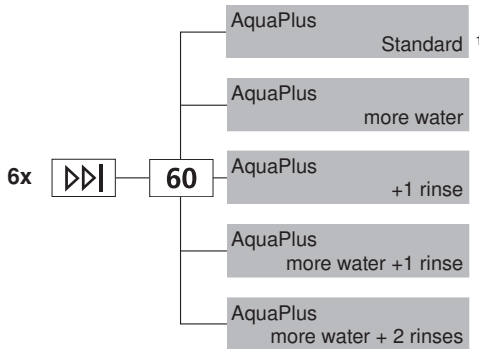

- **Standard:** Normal water level.
- **more water:** Increased water level.
- **+ 1 rinse:** 1 additional rinsing cycle.
- **more water + 1 rinse:** Increased water level, 1 additional rinsing cycle.
- **Skin protection:** Increased water level, 2 additional rinsing cycles.

## 5.8 Hygiene info

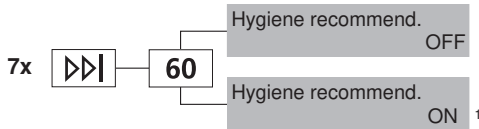

When the function is turned on, a wash of at least 60 °C is recommended for hygiene reasons whenever the formation of foul smelling coatings in the appliance is to be prevented.

## 5.9 Soft water

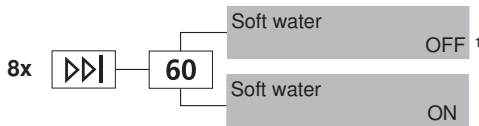

When the function is turned on, adjusting for very soft water prevents heavy foaming.

## 5.10 Childproof lock

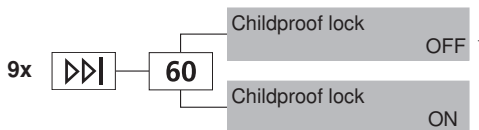

The childproof lock prevents a programme from being started accidentally. A programme can only be started by pressing two buttons at the same time.

## 5.11 Automatic door opener

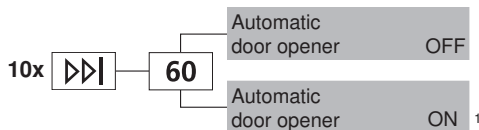

When the function is turned on, the appliance door opens automatically when the programme ends. When the function is turned off, the appliance door can be opened by pressing the  button.

<sup>1</sup> Factory setting

## 5.12 Loosening up the washing

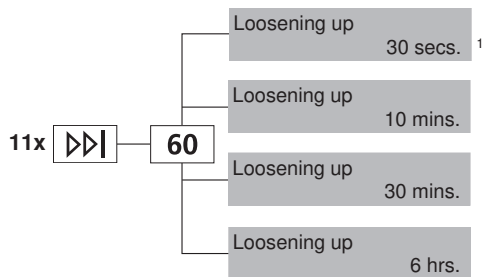

Touch the button at any time to open the appliance door. The washing can be unloaded.

## 5.13 Silent

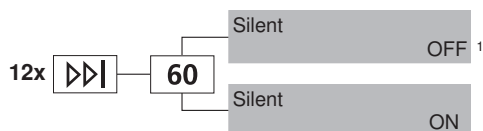

When the function is turned on, programmes with the additional function «Eco» are quieter. This extends the programme duration slightly.

## 5.14 Brightness

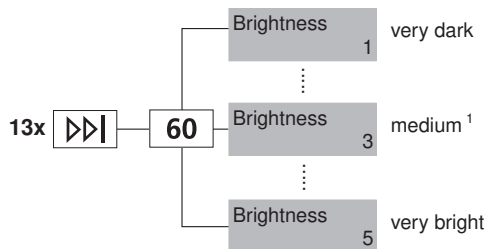

The display can be adjusted to the prevailing lighting conditions.

## 5.15 Button tone

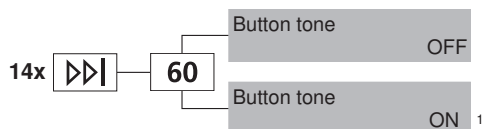

The button tone can be turned on and off. The button tone for the and buttons cannot be turned off.

<sup>1</sup> Factory setting

## 5.16 Factory settings

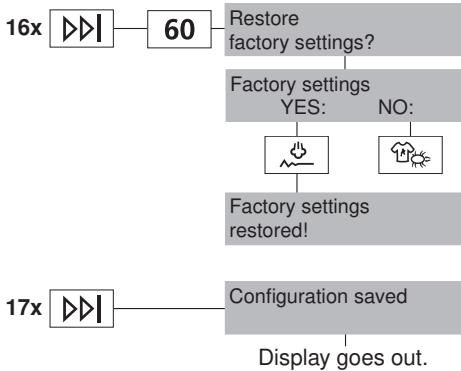

The factory settings can be restored. The language if changed is not reset to the factory setting.

## 6 Care and maintenance

Using the correct dosage of detergent will automatically clean the inside of the appliance. Immediately wipe away all traces of detergent with a soft cloth to avoid staining.

### 6.1 Cleaning the detergent dispenser drawer (as required)

#### Cleaning the detergent compartments

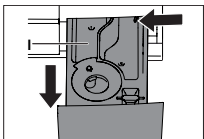

- ▶ Pull the detergent dispenser drawer out as far as it will go, push the release lever to the left and remove the detergent dispenser drawer.
- ▶ Wash out the detergent compartments.
- ▶ Clean the duct under the pre-wash detergent compartment **I**.

#### Cleaning the siphon and suction tube

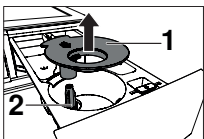

- ▶ Pull siphon **1** in fabric conditioner compartment upwards and out.
- ▶ Clean the siphon **1** and suction tube **2**.
- ▶ Insert the siphon again correctly.

## 6.2 Cleaning the water inlet filter



Test the water inlet for leaks following maintenance work.

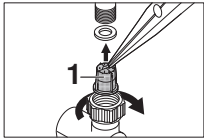

- ▶ To avoid blockages, periodically check and, if necessary, clean the water inlet filter **1**.

## 6.3 Emergency draining



The water in the appliance may be hot. Scalding hazard! Allow to cool down before emergency draining.

In the event of a blocked water outlet or drain pump, a malfunction or a power failure, if there is water still in the appliance it must be drained off as follows:

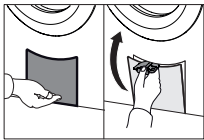

- ▶ Open the drain tray by pressing it bottom right or with the use of the liquid detergent flap.

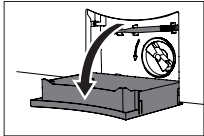

- ▶ Fold the drain tray right down. It also functions as a receptacle for collecting any water that runs out.

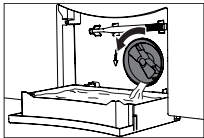

- ▶ Carefully release the foreign body trap somewhat by turning it anti-clockwise and steadily drain off the water.

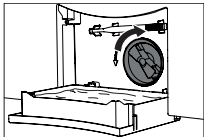

- ▶ Close the foreign body trap by turning it clockwise and remove the drain tray from the front.

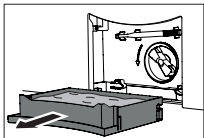

- ▶ Empty the drain tray and then put it back, pushing it in straight as far as it will go.

**Note:** The drain tray can be removed and a larger receptacle used in its place to draining off the water. The appliance can hold up to 30 litres of water.

## 6.4 Cleaning the foreign body trap

**Note:** Clean the foreign body trap at regular intervals as well as after washing, for instance, pet blankets or other wash items that cause a thick build-up of fluff.

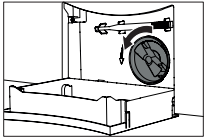

- ▶ Drain off any residual water (see page 28).

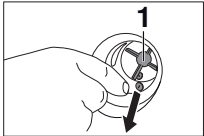

- ▶ Remove any foreign objects (buttons, coins, etc.) from around the impeller **1**.

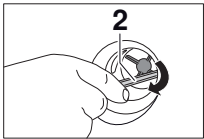

- ▶ Using the emergency door release tool **2**, check that the drain pump impeller can turn.

**Note:** The impeller **1** may turn stiffly. This is construction related and does not indicate the presence of any foreign object or defect. If the impeller does not turn, please contact our Customer Services.



- ▶ Push the foreign body trap in as far as it will go and then turn clockwise as far as it will go.

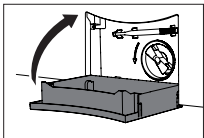

- ▶ Put the drain tray back and close it to.

## 6.5 Opening the appliance door in the event of a power failure



Wait until the washing drum is completely stationary. A washing drum that is still rotating poses a risk of serious injury.

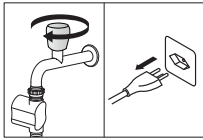

- ▶ Close the water tap and disconnect the appliance from the mains.

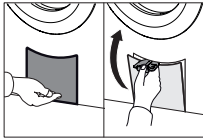

- ▶ Open the drain tray by pressing it at the bottom or with the use of the liquid detergent flap.

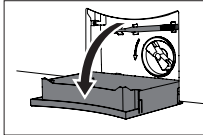

- ▶ Fold the drain tray right down. If necessary, carry out emergency draining.

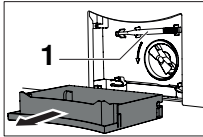

- ▶ Remove drain tray.
- ▶ Remove the emergency door release tool **1** from its bracket.

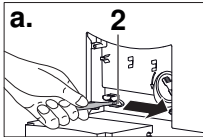

- ▶ Insert emergency door release tool into blue opening cap **2** and turn in direction of arrow.

**a.** Door opens from right

**b.** Door opens from left

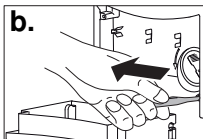





The appliance door springs open.



**Note:** If the emergency door release tool is missing, a screw driver can be used instead.

## 7 Trouble-shooting

You may be able to trouble-shoot the following errors yourself. If not, note down the error message in full (message, F and E numbers) and call Customer Services.

### 7.1 Error messages



Display	Possible cause	Solution
<b>A2</b> Check water outlet	<ul style="list-style-type: none"> <li>▪ The foreign body trap is clogged.</li> <li>▪ The drain pump is blocked.</li> <li>▪ The drain hose is bent or kinked.</li> <li>▪ The outlet or drain trap is clogged.</li> </ul>	<ul style="list-style-type: none"> <li>▶ Check cause (see page 29).</li> <li>▶ Press the  button.</li> <li>▶ Restart the programme.</li> </ul>
<b>A3</b> Clean foreign body trap	<ul style="list-style-type: none"> <li>▪ The foreign body trap is clogged.</li> </ul>	<ul style="list-style-type: none"> <li>▶ Check cause (see page 29).</li> <li>▶ Press the  button.</li> <li>▶ Restart the programme.</li> </ul>
<b>A5</b> Spin stop: Unbalanced load	<ul style="list-style-type: none"> <li>▪ Large items are unevenly distributed in the washing drum.</li> <li>▪ Pillows or similar items in the wash.</li> <li>▪ Wash items are tangled.</li> </ul>	<ul style="list-style-type: none"> <li>▶ Wash large and small items together.</li> <li>▶ Remove the pillows.</li> <li>▶ Spin the washing again.</li> <li>▶ Spin the pillows separately.</li> <li>▶ Separate the wash items.</li> <li>▶ Fasten duvet covers and pillow cases.</li> <li>▶ Spin the washing again.</li> </ul>
<b>A6</b> Check foreign body trap	<ul style="list-style-type: none"> <li>▪ The foreign body trap is missing or is not sitting correctly.</li> </ul>	<ul style="list-style-type: none"> <li>▶ Check cause (see page 29).</li> <li>▶ Press the  button.</li> <li>▶ Restart the programme.</li> </ul>
<b>A9</b> Check water inlet	<ul style="list-style-type: none"> <li>▪ The water tap is turned off.</li> <li>▪ The water inlet filter is clogged.</li> <li>▪ Water supply is interrupted.</li> <li>▪ Water pressure is too low.</li> </ul>	<ul style="list-style-type: none"> <li>▶ Clean water inlet filter or restore water supply (see page 28).</li> <li>▶ Press the  button.</li> <li>▶ Restart the programme.</li> </ul>

Display	Possible cause	Solution
<b>F6/E77</b> see instructions FN XXXXX XXXXXX	<ul style="list-style-type: none"> <li>▪ Anti-leak protection was triggered.</li> </ul>	<ul style="list-style-type: none"> <li>▶ Turn off water tap.</li> <li>▶ Note down error message in full and appliance's FN.</li> <li>▶ Press the  button.</li> <li>▶ Call Customer Services.</li> </ul>
<b>FXX/EXX</b> see instructions FN XXXXX XXXXXX	<ul style="list-style-type: none"> <li>▪ Various situations can lead to an "F" message.</li> </ul>	<ul style="list-style-type: none"> <li>▶ Press the  button.</li> <li>▶ Switch off the power supply for about 1 minute.</li> <li>▶ Switch the power supply back on again and select a new programme.</li> </ul>
	<ul style="list-style-type: none"> <li>▪ If the error appears again:</li> </ul>	<ul style="list-style-type: none"> <li>▶ Note down error message in full and appliance's FN.</li> <li>▶ Interrupt the water and power supply.</li> <li>▶ If there is laundry in the appliance: carry out emergency draining, use emergency door release and unload laundry.</li> <li>▶ Call Customer Services.</li> </ul>
<b>H20</b>	<ul style="list-style-type: none"> <li>▪ The water counter in the inlet hose is defective. It is still possible to wash without a problem. The water consumption displayed can deviate from the actual consumption.</li> </ul>	<ul style="list-style-type: none"> <li>▶ Call Customer Services.</li> </ul>
<b>U1/E27</b> see instructions FN XXXXX XXXXXX	<ul style="list-style-type: none"> <li>▪ Faulty electrical connection.</li> <li>▪ Overvoltage.</li> </ul>	<ul style="list-style-type: none"> <li>▶ Press the  button.</li> <li>▶ Switch off the power supply for about 1 minute.</li> <li>▶ Switch the power supply back on again and select a new programme.</li> </ul>
	<ul style="list-style-type: none"> <li>▪ If the error appears again:</li> </ul>	<ul style="list-style-type: none"> <li>▶ Have an electrician check the house installation.</li> <li>▶ Note down error message in full and appliance's FN.</li> <li>▶ Disconnect from the power supply.</li> <li>▶ Call Customer Services.</li> </ul>





Display	Possible cause	Solution
Foam in main wash: Rinsing extended	<ul style="list-style-type: none"> <li>If there is very heavy foaming, the programme is automatically extended by a rinsing cycle. This improves the wash results, but extends the programme time.</li> </ul>	<ul style="list-style-type: none"> <li>Reduce the amount of washing detergent used next time.</li> <li>Adjust detergent dosage to water hardness (see page 14).</li> </ul>
Hygiene recommend.	<ul style="list-style-type: none"> <li>No wash cycle has been carried out at a temperature of at least 60 °C for a longer period of time.</li> </ul>	<ul style="list-style-type: none"> <li>With one of the next wash cycles carry out a wash with at least 60° C.</li> </ul> <p>Or:</p> <ul style="list-style-type: none"> <li>Run «Appliance hygiene» programme without laundry (see page 20).</li> </ul>
Inlet water very cold: Heating extended	<ul style="list-style-type: none"> <li>Inlet water is very cold. Heating is extended.</li> </ul>	<ul style="list-style-type: none"> <li>No action is necessary.</li> </ul>
Too many items: Heating extended	<ul style="list-style-type: none"> <li>The selected programme is intended for a smaller load. Heating and possibly rinsing is extended.</li> </ul>	<ul style="list-style-type: none"> <li>Adjust load to the max. load size (see page 12).</li> </ul>
Large unbalanced load: Spin extended	<ul style="list-style-type: none"> <li>The appliance optimizes the distribution of the wash load to compensate an unbalanced load. The final spin is extended.</li> </ul>	<ul style="list-style-type: none"> <li>Wash large and small items together to avoid large unbalanced loads.</li> </ul>

## 7.2 Other possible problems

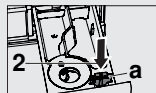



Problem	Possible cause	Solution
The washing has not been spun or has been spun insufficiently.	<ul style="list-style-type: none"> <li>The spin speed set is too low.</li> </ul>	<ul style="list-style-type: none"> <li>Increase the spin speed for the next wash cycle (see page 23).</li> </ul>
	<ul style="list-style-type: none"> <li>Too large an unbalanced load in the washing drum.</li> </ul>	<ul style="list-style-type: none"> <li>Wash large and small items together.</li> </ul>
	<ul style="list-style-type: none"> <li>«Steam anti-crease» was selected and the appliance was not standing level.</li> </ul>	<ul style="list-style-type: none"> <li>Optimize appliance set-up according to installation instructions.</li> </ul>

Problem	Possible cause	Solution
The appliance vibrates heavily when spinning.	▪ The transport lock has not been removed.	▶ Remove transport lock (see page 4).
	▪ The feet of the appliance are not properly adjusted.	▶ Set appliance feet so that the appliance stands level.
	▪ The load could not be optimally balanced in the washing drum.	▶ Wash large and small items together.
At the end of the programme, the appliance door cannot be opened with the  button.	▪ The appliance door is stuck.	▶ Press hard against the lock side of the appliance door (i.e. front edge of appliance door). ▶ Press the  button again.
	▪ An interruption in the power supply.	▶ Use the emergency door release (see page 30).
Water sounds after programme has finished when washing drum is turned by hand.	▪ The vanes are filled with water to compensate the unbalanced load.	▶ The water is automatically pumped off. No action is necessary.
Traces of conditioner or water in fabric conditioner compartment.	▪ Siphon in fabric conditioner compartment is missing or not inserted correctly.	▶ Insert the siphon correctly (see page 27).
	▪ Siphon or suction tube is clogged.	▶ Clean siphon and suction tube (see page 27).
Traces of powder detergent in detergent compartment.	▪ Damp or lumpy washing detergent.	▶ Store washing detergent in a dry place.
	▪ Washing detergent compartment was damp and a delayed start was selected.	▶ Wipe detergent compartment dry before adding the detergent.
	▪ Water flow pressure is too low.	▶ Open water tap fully.
	▪ Water inlet is scaled up.	▶ Check water supply and, if necessary, clean the water inlet filter (see page 28).
	▪ Flap <b>a</b> was inserted in position <b>1</b> for liquid detergent.	▶ Pull flap <b>a</b> out and insert into position <b>2</b> (see page 13).



Problem	Possible cause	Solution
Laundry is still dry after programme has finished – no error message.	<ul style="list-style-type: none"> <li>«Demo mode» is turned on.</li> </ul>	<ul style="list-style-type: none"> <li>Open the appliance door.</li> <li>Hold the   and <b>60</b> buttons depressed.</li> <li>Simultaneously press the  button. «Demo mode ON» appears in the display.</li> <li>Press the <b>95</b> button. «Demo mode OFF» appears in the display.</li> <li>Press the  button repeatedly until the display goes out.</li> </ul>

### 7.3 Unsatisfactory wash results

Result	Possible cause	Solution
White residue on washing	<ul style="list-style-type: none"> <li>Despite intensive rinsing, badly soluble compounds in the detergent can be left on the washing.</li> </ul>	<ul style="list-style-type: none"> <li>Shake out or brush the wash items.</li> <li>Wash the items again with just a little washing detergent.</li> <li>Use a liquid detergent that does not contain zeolites.</li> <li>Select additional function   .</li> </ul>
Grey residue on washing	<ul style="list-style-type: none"> <li>Grease and dirt particles left behind.</li> <li>Residue from detergent, limescale and dirt</li> <li>Washing drum is overloaded.</li> </ul>	<ul style="list-style-type: none"> <li>Increase detergent dosage.</li> <li>Use heavy-duty washing detergent.</li> <li>Adjust amount of detergent to water hardness and degree of soiling of washing (see page 14).</li> <li>Put less laundry into the washing drum (see page 12).</li> </ul>
Washing feels hard	<ul style="list-style-type: none"> <li>Poor rinsing effect through very soft water (below 15 °fH).</li> </ul>	<ul style="list-style-type: none"> <li>Select user setting «soft water» (see page 25).</li> </ul>
Unsatisfactory wash result using detergent for coloureds	<ul style="list-style-type: none"> <li>Washing detergent used does not contain bleach.</li> <li>Exceptionally heavily soiled washing.</li> </ul>	<ul style="list-style-type: none"> <li>Use washing detergent containing bleach (see page 13).</li> <li>More intensive programme, e.g. degree of soiling   «heavily soiled».</li> </ul>

<b>Result</b>	<b>Possible cause</b>	<b>Solution</b>
Unsatisfactory wash result using liquid detergent	<ul style="list-style-type: none"> <li>▪ Liquid detergent does not contain bleach.</li> </ul>	<ul style="list-style-type: none"> <li>▶ Use washing detergent containing bleach (see page 13).</li> </ul>
Soap deposits on washing	<ul style="list-style-type: none"> <li>▪ Water hardness is too high.</li> </ul>	<ul style="list-style-type: none"> <li>▶ Soap detergent should only be used if the water hardness is below 25 °fH (see page 14).</li> </ul>
Unsatisfactory rinsing performance	<ul style="list-style-type: none"> <li>▪ Too much washing detergent.</li> </ul>	<ul style="list-style-type: none"> <li>▶ Adjust washing detergent dosage to water hardness and degree of soiling (see page 14).</li> </ul>
	<ul style="list-style-type: none"> <li>▪ Very soft water (below 15 °fH)</li> </ul>	<ul style="list-style-type: none"> <li>▶ Select user setting «soft water» (see page 25).</li> </ul>
Fabric stains	<ul style="list-style-type: none"> <li>▪ Rust stains</li> </ul>	<ul style="list-style-type: none"> <li>▶ Brush out pockets in garments.</li> </ul>
	<ul style="list-style-type: none"> <li>▪ Chemical effect</li> </ul>	<ul style="list-style-type: none"> <li>▶ Wash items with metal parts separately.</li> </ul>
	<ul style="list-style-type: none"> <li>▪ Residues from hair care products, cosmetics and plants can react with the suds to cause a chemical reaction that can result in staining.</li> </ul>	
Colour run	<ul style="list-style-type: none"> <li>▪ Non-fast colours in the wash.</li> </ul>	<ul style="list-style-type: none"> <li>▶ Wash white and coloured textiles separately.</li> <li>▶ Follow fabric care labels (see page 8).</li> </ul>
	<ul style="list-style-type: none"> <li>▪ Items in the wash whose colour has run.</li> </ul>	<ul style="list-style-type: none"> <li>▶ Empty garment pockets.</li> </ul>
Holes, rips or tears	<ul style="list-style-type: none"> <li>▪ Items in the wash with zips or hooks open.</li> </ul>	<ul style="list-style-type: none"> <li>▶ Fasten zip fasteners and hooks before washing.</li> <li>▶ Wash delicates in a laundry bag or pillow case.</li> <li>▶ Turn pockets inside out.</li> <li>▶ Empty garment pockets.</li> </ul>
	<ul style="list-style-type: none"> <li>▪ Chemical effect of washing detergent, textile quality</li> </ul>	<ul style="list-style-type: none"> <li>▶ Do not put washing detergent directly onto the laundry.</li> </ul>
	<ul style="list-style-type: none"> <li>▪ Washing drum damaged by foreign objects (e.g. nails, paper clips, etc.)</li> </ul>	<ul style="list-style-type: none"> <li>▶ Inspect washing drum for foreign objects and damage.</li> <li>▶ Remove foreign objects.</li> <li>▶ Call Customer Services if the washing drum is damaged.</li> </ul>

Result	Possible cause	Solution
Fabric wear	▪ Washing drum over-loaded	▶ Put less laundry into the washing drum (see page 12).
	▪ Friction between fabrics during washing.	▶ Select additional function  «Easy care».
	▪ Pilling	▶ Turn items inside out before washing.

## 8 Spare parts

Please give product family and exact designation when ordering parts.

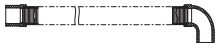

Drain hose 1.5 m /  
4.0 m



Emergency door re-  
lease tool

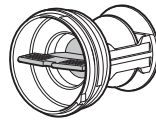

Foreign body trap

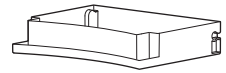

Drain tray



Siphon

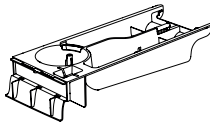

Detergent dis-  
penser drawer

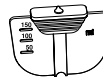

Liquid detergent  
flap

## 9 Technical data

### Dimensions

Height	85 cm
Width	59.5 cm
Depth	62.5 cm
Weight	70 kg
Pumping height of pump	1.2 m
Dry load capacity	8 kg

### Spin speed

400, 600, 800, 1000, 1200,  
1400, 1600 rpm

### Electrical connection

See identification plate:

- ▶ Open the drain tray.

The identification plate is located next to the foreign body trap.

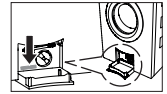



### Plumbing in

Connection to water supply	Cold water G $\frac{3}{4}$ "
Permitted pressure of water supply	0.1–0.6 Mpa (1–6 bar)
Max. pumping height of drain pump	1.2 m

## 9.1 Note for testing institutes

Set to the standard programmes according to AS/NZS 2040.2:2005 :

Programme	Load capacity	
40 °C Coloureds normal	8 kg	▶ Press the  button 1x.
10 °C Coloureds normal	8 kg	▶ Press the  button 2x.

For test institutes we recommend for the measurement of end mode the door remains open so that it matches normal use without user intervention. Note at the point of end mode the door will automatically pop open.

### Data for the 40 °C Coloureds normal programme

Load capacity	Programme duration	Energy star rating	Energy consumption	Water star rating	Water consumption	Residual moisture
kg	hrs./mins.		kWh/cycle		l/cycle	%
8	3h50	4	0.81	4	78	57

## 9.2 Consumption values

The consumption data and programme times given serve only as a guide. They refer to the maximum load capacity and can vary with, for instance, towelling material, a very cold water feed, the degree of soiling selected or a smaller wash load. The time remaining shown and the programme end time are adjusted accordingly.

### Whites and coloureds programmes

Programme	Load kg	Spin speed <sup>1</sup> rpm	Duration hrs./mins.	Water Litres	Energy kWh
Whites 95 °C	1–8	1200	1h41	75	2.2
Coloureds 60 °C	1–8	1200	1h18	65	1.3
Coloureds 40 °C	1–8	1200	1h08	70	0.8
Coloureds 30 °C	1–8	1200	1h05	70	0.5
Coloureds 20 °C	1–8	1200	1h02	70	0.3
Woollens 30 °C	1–2.5	800	0h48	52	0.3
Hand wash 20 °C	1–2	600	0h45	58	0.2

<sup>1</sup> Factory setting

### Extra programmes

Programme	Load kg	Spin speed <sup>1</sup> rpm	Duration hrs./mins.	Water Litres	Energy kWh
Steam anti-crease	1–1.5	0	0h23	1	0.1
Proofing 20 °C	1–3	800	0h28	12	0.2
Appliance hygiene	0	0	0h30	9	0.7

<sup>1</sup> Factory setting

## 9.3 VAS Vibration Absorbing System

As the washing drum starts to spin, if the control unit detects that the load is out of balance it will interrupt the spinning action once or more. In this case, the appliance tries to improve the distribution of the wash load in the washing drum.

When spinning, at all spin speeds the load is, where necessary, actively balanced in the washing drum, whereby the hollow vanes are filled with the necessary quantity of water. This ensures optimal care and draining of the washing.

## 9.4 Water and energy economy

During the first few minutes of a programme running, sensors automatically determine the type and the size of the load being washed.

Water levels are then optimally adjusted to the wash load so that only the strict amount of water needed is used.

## 9.5 Automatic energy-saving stand-by

The appliance is equipped with automatic energy-saving stand-by to avoid consuming energy unnecessarily.

All displays go out within minutes of a programme finishing. Energy consumption is reduced to an absolute minimum. The safety functions, however, remain activated.

# 10 Washing tips

## 10.1 Energy and water economy

- Where possible fill the drum to the maximum load capacity of the relevant programme.
- Select «Pre-wash» or «Soaking» only for washing that is heavily soiled or stained.
- For lightly soiled washing without staining select the «20 °C» main wash programme or the additional function «Sprint».
- Select additional function «Eco» if the duration of the programme or the germ-killing effect of high temperatures do not play a role.
- Select additional function «OptiTime» if washing using a delayed start or the germ-killing effect of high temperatures do not play a role.

### Spin speed

How much energy is consumed by subsequent tumble drying depends on the spin speed set. The higher the spin speed set, the lower the remaining moisture content of the washing at the end of the programme.

rpm	1600	1400	1200	1000	800	600	400
<b>Residual moisture (cotton)</b>	~44%	~47%	~52%	~60%	~70%	~90%	~110%

### Automatic door opener

Use the appliance with the automatic door opener switched on. When the appliance door opens the appliance immediately enters the lowest possible stand-by power consumption state.

## 10.2 Avoiding damage

- Follow the fabric care symbols on garment labels.
- The wash temperature selected should agree with the recommended temperature range of the washing detergent to ensure the washing detergent is at its most effective.
- Wash white and coloured textiles separately.
- Empty pockets and turn inside out. Remove any foreign objects (coins, nails, paper clips, etc.).
- Empty and brush out pockets of work overalls worn in the metal industry. Metal shavings can damage the washing and cause rust stains.
- Fasten hook and eye fasteners and zips. These can damage the laundry and the drum.
- Fasten cloth belts, apron ties and duvet and pillow cases to avoid them getting tangled up.
- Wash smaller items (e.g. nylon tights, belts) and items with zips and hooks in a washing net or cushion cover.
- Remove stains before washing using a suitable stain remover.
- Pre-treat heavily soiled areas (collars, cuffs, etc.) with soap, special detergent or paste.
- Textiles, such as dog or horse blankets, that are covered in animal hair should be brushed out before washing.

## 11 Disposal

### 11.1 Packaging



Never allow children to play with packaging material due to the danger of injury or suffocation. Store the packaging material in a safe location or dispose of it in an environmentally-friendly way.

### 11.2 Safety

Render the appliance unusable to prevent accidents caused by improper use (e.g. through children playing):

- ▶ Disconnect the appliance from the mains. With a fixed appliance, this is to be carried out by a qualified electrician. Then cut the mains cable off flush with the appliance.
- ▶ Remove or disable the lock on the appliance door.

### 11.3 Disposal



-  The «crossed-out wheeie bin» symbol indicates that waste electrical and electronic equipment (WEEE) must be specially disposed of. Such equipment can contain dangerous and environmentally harmful substances.
- These appliances must be taken to an official collection point for recycling electrical and electronic equipment and must not be disposed of with ordinary household waste. In this way, you help conserve resources and protect the environment.
- Please contact your local authorities for more information.

# 12 Notes



## 13 Quick instructions

**Please first read the safety precautions in the operating instructions.**

### Starting programme

- ▶ Switch on appliance and turn on water tap.
- ▶ Press the  button. Appliance door opens.
- ▶ Load laundry.

- ▶ Add washing detergent to detergent dispenser drawer.

### When programme has finished

- ▶ Press the  button and unload the laundry.
- ▶ Clean detergent dispenser drawer.
- ▶ Push appliance door to, but do not close.

## 14 Services & support

Register your appliance today online via our website at [www.vzug.com](http://www.vzug.com) and benefit from the best possible support in the event of a malfunction – including during the manufacturer's 2-year warranty period. You will require the serial number (FN) and appliance designation to register your appliance. You will find them on the identification plate of your appliance.

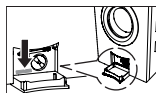

You can also note the serial number and device designation here or on the service sticker which comes with the appliance:

**FN:** \_\_\_\_\_

**Appliance:** \_\_\_\_\_

### Your repair order

You can find the telephone number of the nearest V-ZUG service centre to you under [www.vzug.com](http://www.vzug.com)→Service→Service hotline.

### General queries, accessories and service agreement

V-ZUG will be happy to help you with any general administrative or technical queries, to accept your orders for accessories and spare parts and to inform you about our progressive service agreements.

