



# OWNER'S MANUAL



## TE SERIES EQUIPMENT STANDS

\*Please Note: This manual is intended for use with the above referenced equipment manufactured after October 2024. Traulsen's equipment stands are solely intended for use with cooking equipment. To obtain a copy of the correct Owner's Manual to support the same products manufactured prior to this date, please contact Traulsen Service at (800) 825-8220.

4401 Blue Mound Road Fort Worth, Texas 76106 (USA)

Phone: 800.825.8220 | Service Fax: 817.740.6757 | E-mail: [service@traulsen.com](mailto:service@traulsen.com) | Website: [traulsen.com](http://traulsen.com)

Hours of Operation: Monday - Friday 7:30 a.m. - 4:30 p.m. (CST)



<b>I. THE SERIAL TAG</b>	Page 1	<b>VI. DRAWERS</b>	
<b>II. RECEIPT INSPECTION</b>	Page 2	a) Removing Drawers/Frame Modules	Page 4
<b>III. INSTALLATION</b>		<b>VII. MICROPROCESSOR CONTROL</b>	
a) Location	Page 2	a) Information Menu	Page 4
b) Packaging	Page 2	b) Adjusting Cabinet Setpoint	Page 4
c) Adjusting the Casters	Page 2	c) Initiating a Defrost	Page 5
d) Cord & Plug	Page 2	d) Configuration Parameters	Page 5
e) Power Supply	Page 2	e) Technical Data	Page 5
f) Placing Equipment on Top of Unit	Page 3	f) Components & Wiring Diagram	Page 10
<b>IV. OPERATION</b>	Page 3	<b>VIII. TROUBLE SHOOTING GUIDE</b>	Page 11
<b>V. CARE &amp; MAINTENANCE</b>		<b>IX. SERVICE/WARRANTY INFORMATION</b>	
a) Cleaning the Condenser Filter	Page 3	a) Service Information	Page 12
b) Replacing the Gaskets	Page 3	b) Spare Parts Information	Page 13
c) Cleaning the Cabinet Surface	Page 4	c) Warranty Registration	Page 13

## I. THE SERIAL TAG

The serial tag is a permanently affixed label on which is recorded vital electrical and refrigeration data about your Traulsen product, as well as the model and serial number. This tag is located in the right interior compartment on all standard equipment stand models.

### READING THE SERIAL TAG

- Serial = The permanent ID# of your Traulsen unit
- Model = The model # of your Traulsen unit
- Volts = Voltage
- Hz = Cycle
- PH = Phase
- Total Current = Maximum amp draw
- Minimum Circuit = Minimum circuit ampacity
- Lights = Light wattage
- Heaters = Heater amperage (hot food units only)
- Refrigerant = Refrigerant type used
- Design Pressure = High & low side operating pressures and refrigerant charge
- Agency Labels = Designates agency listings

		ITW Food Equipment Group, LLC North American Refrigeration 4401 Blue Mound Rd. Ft. Worth, TX 76106 800-825-8220			
		<b>MODEL:</b> <b>MODELO:</b> <b>MODELE:</b>	<b>TE036HT</b>		
<b>SERIAL NUMBER:</b>	<b>25C02307</b>			SCAN FOR SERVICE INFO	
<b>REFRIGERANT / REFRIGERANTE / RÉFRIGÉRANT</b>					
<b>SYS1 (REFM):</b>	<b>R-290</b>	<b>4.50 OZ</b>	<b>127.56 g</b>	<b>127.56 g</b>	
<b>Hi Press. (PRESH):</b>		<b>450.00 psi</b>	<b>3,102.64 kPa</b>	<b>3,102.64 kPa</b>	
<b>Lo Press. (PRESL):</b>		<b>200.00 psi</b>	<b>1,378.95 kPa</b>	<b>1,378.95 kPa</b>	
<b>SYS2 (REFA):</b>	<b>NA</b>				
<b>Hi Press. (PRESH):</b>					
<b>Lo Press. (PRESL):</b>					
<b>Input Power (ELIN) - FOR INDOOR USE ONLY</b>					
<b>Voltage</b>	<b>Hertz</b>	<b>Phase</b>	<b>Total Amps</b>		
115 ~	60	1	4.50		
<b>Device/Part Number:</b>		<b>Device/Part Notes:</b>			
TE036HT-ZCF01					
					
					
<b>COMPONENTS / COMPOSANTS / COMPONENTES</b>					
	<b>1</b>	<b>2</b>	<b>MAX OVER CURRENT PROTECTION (A):</b>		
<b>COMP AMPS:</b>			<b>MIN CIRCUIT IN AMPS:</b>		
<b>COND FAN AMPS:</b>			<b>DOME LIGHT WATTS:</b>		
<b>EVAP FAN AMPS:</b>			<b>DISPLAY LIGHT WATTS:</b>		
<b>CONTROL AMPS:</b>			<b>DOOR HEATER WATTS:</b>		
<b>DEF HEATER WATTS:</b>			<b>B/TMCE HTR WATTS:</b>		
370-60297-00 REV. D 01/15/2024					

## II. RECEIPT INSPECTION

All Traulsen products are factory tested for performance and are free from defects when shipped. The utmost care has been taken in crating this product to protect against damage in transit.

You should carefully inspect your Traulsen unit for damage during delivery. If damage is detected, you should save all the crating materials and make note on the carrier's Bill Of Lading describing the damage. A freight claim should be filed immediately. If damage is subsequently noted during or immediately after installation, contact the respective carrier and file a freight claim. There is a five (5) day limit to file freight damage with the carrier. Under no condition may a damaged unit be returned to Traulsen without first obtaining written permission (return authorization). You may contact Hobart/Traulsen customer care at 800-333-7447 to request a return.

### Systems Using Refrigerant R-290 (Propane)

Traulsen has selected propane as the refrigerant for many of their products. In addition to its low global warming potential and impact on the environment, propane is an ideal refrigerant. It is a flammable refrigerant, however, which is why you will see a "flammable refrigerant" sticker on applicable products. Traulsen products using propane as the refrigerant are UL approved and are safe to use in accordance with this Owner's Manual and general industry practices for commercial cooking environments. Please check with local codes or regulations for any restrictions to products using hydrocarbon refrigerants.

## III. INSTALLATION

### III. a) LOCATION

Unit must be placed on level floor for proper use.

### III. b) PACKAGING

Your Traulsen unit was shipped from the factory packaged with stretch wrap material.

Most exterior stainless steel surfaces have a protective blue vinyl covering to prevent scratching during manufacturing, shipping and installation. After the unit is installed in place of application peel, remove and discard the covering from all surfaces.

The equipment stands are shipped on a skid that is designed to allow a unit to be slid off the skid onto the factory installed casters. When a unit is being removed from the skid two or more runners will act as slides and will remain with the unit while it is being removed. These runners prevent damage to the machine when it drops off the skid to the floor.

### III. b) PACKAGING CONT'D

To unload the machine, remove the exterior packaging. Next, remove the bolts that attach the skid to the machine as shown in (A).

Finally, push the machine off the skid keeping the length of the machine parallel to the skid's 4x4 pieces. On longer machines this may require two or more individuals.

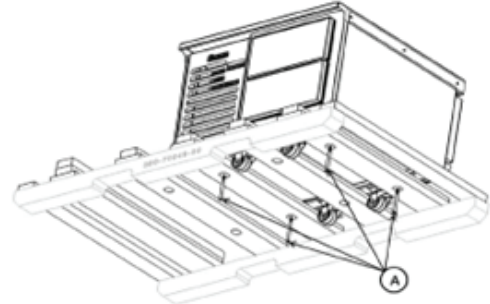

**NOTE:** Traulsen does not recommend laying the unit on its front, side or back. If you must, please allow the unit to remain in an upright position for 24 hours before plugging it in so that the compressor oils and refrigerant may settle.

### III. c) ADJUSTING THE CASTERS

To adjust the caster loosen the two bolts and move caster to desired location, spacing between casters not to exceed 48 inches. Casters on each end of the unit can not exceed 8 inches from the end of the cabinet.

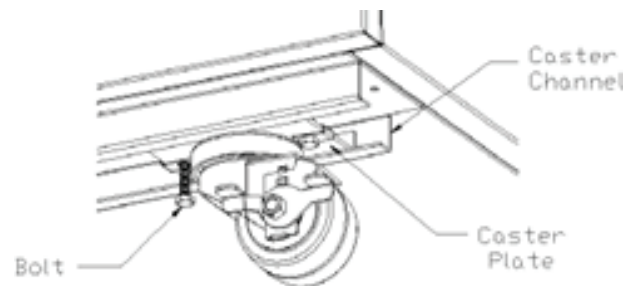

### III. d) CORD & PLUG

All self-contained models are shipped standard with a NEMA 5-15P plug and 9 foot cord and spring retainer attached at the rear of the cabinet. Select only a dedicated electrical outlet for power source.

**NOTE:** Do not under any circumstances, cut or remove the round grounding prong from the plug, or use an extension cord.

### III. e) POWER SUPPLY

The supply voltage should be checked prior to connection to be certain that proper voltage for the cabinet wiring is available (refer to the serial tag to determine correct unit voltage). Make connections in accordance with local electrical codes. Use qualified electricians.

### III. e) POWER SUPPLY CONT'D

Use of a separate, dedicated circuit is required. Size wiring to handle indicated load and provide necessary over current protector in circuit (see amperage requirements on the unit's serial tag).

### III. f) PLACING EQUIPMENT ON TOP OF UNIT

Equipment may be placed on top of your Traulsen equipment stand. A stainless steel worktop, provided standard is required on cabinets being used to support equipment weighing in excess of 100 lbs. or producing heat in excess of 140°F to the top surface. Refer to below chart to determine maximum top load capacity for your unit.

MODEL	MAX TOP LOAD CAPACITY
TE036HT	625 lbs
TE048HT	625 lbs
TE060HT	1,200 lbs
TE072HT	1,200 lbs
TE084HT	1,500 lbs
TE096HT	1,500 lbs
TE110HT	1,500 lbs
TE048LT	625 lbs
TE060LT	1,200 lbs
TE072LT	1,200 lbs
TE084LT	1,500 lbs

## IV. OPERATION

Refrigerators do not require manual defrosting. During normal operation, a refrigerator continuously circulates above freezing cabinet air through the coil. A compressor "OFF" cycle occurs every 2-1/2 Hours for 20 minutes to melt any frost which may accumulate on the coil during the compressor "ON" cycle. The control will read set point temperature, and the half water-half snowflake will be illuminated. With standard holding refrigerators, high relative humidity is also maintained to prevent dehydration of stored product.



## V. CARE & MAINTENANCE

### V. a) CLEANING THE CONDENSER FILTER

The most important thing you can do to ensure a long, reliable service life for your Traulsen is to regularly clean the condenser coil and or filter if provided.

**WARNING:** DISCONNECT ELECTRICAL POWER SUPPLY BEFORE CLEANING ANY PARTS OF THE UNIT.

To clean the condenser/filter, first disconnect electrical power to the cabinet and remove the front louver assembly. To do so, place hands under the louver panel and pull out and up to get louver panel off bracket of the unit. See diagram below.

### Systems Using Refrigerant R-290 (Propane)

Remove any ignition source (arc, flame, heat) before cleaning the condenser coil. If the condenser coil is inadvertently damaged during cleaning to the point of causing a refrigerant leak, immediately ventilate the area and call for service.

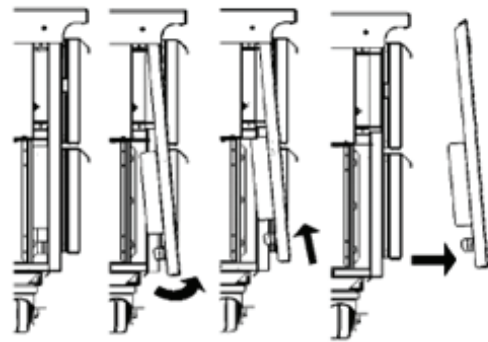

Proceed to vacuum or brush any dirt, lint or dust from the finned condenser coil/filter, the compressor and other cooling system parts. If significant dirt is clogging the condenser fins or filter, use compressed air to blow this clear. To replace the louver assembly reverse the process.

### V. b) REPLACING THE GASKETS

To remove the gasket to be replaced, grasp it firmly by one corner and pull it out. Before attempting to install a new gasket, both the unit and the gasket itself must be at room temperature. Insert the four corners first by using a rubber mallet (or hammer with a block of wood). After the corners are properly inserted, work your way towards the center from both ends by gently hitting with a mallet until the gasket is completely seated in place (see below for proper gasket placement).

**NOTE:** The gasket may appear too large, but if it is installed as indicated above it will slip into place.

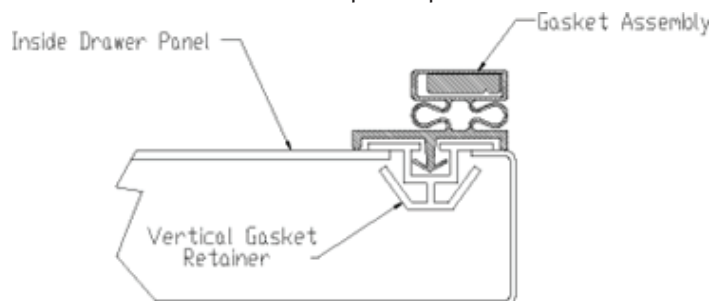

V. c) CLEANING THE CABINET SURFACE

**WARNING:** DISCONNECT ELECTRICAL POWER SUPPLY BEFORE CLEANING ANY PARTS OF THE UNIT.

Exterior stainless steel should be cleaned with warm water, mild soap and a soft cloth. Apply with a dampened cloth and wipe in the direction of the metal grain.

Avoid the use of strong detergents and gritty, abrasive cleaners as they may tend to mar and scratch the surface. Do **NOT** use cleansers containing chlorine, such as bleach, this may promote corrosion of the stainless steel.

Care should also be taken to avoid splashing the unit with water, containing chlorinated cleansers, when mopping the floor around the unit.

For stubborn odor or spills, use baking soda and water (mixed to a 1 tbsp baking soda to 1 pint water ratio).

A stainless steel polish is recommended for shining of unit.

**VI. DRAWERS**

VI. a) REMOVING DRAWERS/FRAME MODULES

Remove the drawer(s) from the drawer frame by lifting up on the drawer and pull out.

Once the drawer(s) have been removed, the drawer frame module can also be removed by loosening the black front and back clamping knobs (2 of each) located on the cross rail locks and liner locks. Slide the front cross rail locks towards the center of the drawer frame module and allow the liner locks to drop down from the top of the liner. Pull the door frame module forward, tip forward and pull out. The entire frame assembly is now free to slide out of the cabinet.

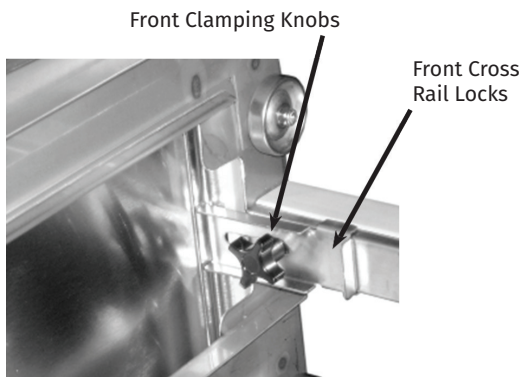

**VII. MICROPROCESSOR CONTROL**

Your new equipment stand is equipped with a digital control, which precisely regulates operation. It is supplied from the factory completely ready for use.



VII. a) INFORMATION MENU

The information available in this menu is:

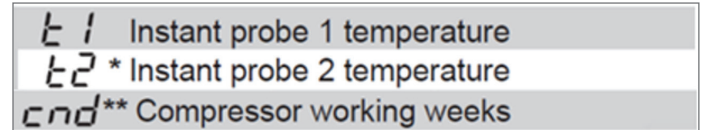

\* displayed only if enabled (see Configuration Parameters)  
 \*\* displayed only if ACC > 0

Access to menu and information displayed:

- Press and immediately release button **i**.
- With button **▼** or **▲** select the data to be displayed.
- Press button **i** to display value.
- To exit from the menu, press button **x** or wait for 10 seconds.

Initiate Stand-By:

Keeping the button **⏻** pressed for 3 seconds allows the controller to be put on a standby or output control to be resumed (with SB=YES only).

Locking the Keypad:

The keypad lock avoids undesired, potentially dangerous operations, which might be attempted when the controller is operating in a public place. In the INFO menu, set parameter LOC = YES to inhibit all functions of the buttons. To resume normal operation of keypad, adjust setting so that LOC = NO.

VII. b) ADJUSTING CABINET SETPOINT

Setpoint display and modification:

- Press button **i** for at least a half second to display the setpoint value.
- While keeping the **i** button pressed, use button **▼** or **▲** to set the desired value (adjustment is within the minimum SPL and the maximum SPH limit). When button **i** is released, the new value is stored.



## VII. c) INITIATING A DEFROST

Automatic defrost:

Defrost starts automatically as soon as the time set with parameter DFT has elapsed.

- **Timed defrost:** With DFM = TIM defrosts take place at regular intervals when the timer reaches the value of DFT. For example, with DFM = TIM and DFT = 36, a defrost will take place every 6 hours.
- **Optimized defrost:** With DFM = FRO the timer is only increased when the conditions occur for frost to form on the evaporator, until the time set with parameter DFT is matched. If the evaporator works at 0°F, defrost frequency depends on the thermal load and climatic conditions. With setpoints much lower than 0°F, defrost frequency mainly depends on the refrigerator operating time.
- **Defrost time count backup:** At the power-up, if DFB = YES, the defrost timer resumes the time count from where it was left off before the power interruption. Vice versa, with DFB = NO, the time count re-starts from 0. In stand-by, the accumulated time count is frozen.

Manual or remote defrost start:

It's possible to manually start a defrost, by pressing button  for 2 seconds.

Defrost type. Once defrost has started, Compressor and Defrost outputs are controlled according to parameter DTY. If FID = YES, the evaporator fans are active during defrost.

Defrost termination. The actual defrost duration is influenced by a series of parameters.

- **Time termination:** T2 = NO and T3 different from 2EU: the evaporator temperature is not monitored and defrost will last as long as time DTO.
- **Temperature monitoring of one evaporator:** T2 = YES and T3 different from 2EU. In this case, if the sensor T2 measures the temperature DLI before the time DTO elapses, defrost will be terminated in advance.

Resuming thermostatic cycle:











When defrost is over, if DRN is greater than 0, all outputs will remain off for DRN minutes, in order for the ice to melt completely and the resulting water to drain. Moreover, if probe T2 is active (T2 = YES), the fans will re-start when the evaporator gets to a temperature lower than FDD; Vice versa, if probe T2 is not active (T2 = NO) or after defrost has come to an end, such condition does not occur by end of the time FTO, after FTO minutes have elapsed the fans will be switched on anyway.

## VII. c) INITIATING A DEFROST CONT'D

Caution: if DFM = NON or C-H = HEA all defrost functions are inhibited; if DFT = 0, automatic defrost functions are excluded.

## VII. d) CONFIGURATION PARAMETERS

Parameter Configuration:

- To get access to the parameter configuration menu, press button  and  for 5 seconds.
- With button  or  select the parameter to be modified.
- Press button  to display the value.
- By keeping button  pressed, use button  or  to set the desired value.
- When button  is released, the newly programmed value is stored and the following parameter is displayed.
- To exit from the setup, press button  or wait for 30 seconds.

## VII. e) TECHNICAL DATA

Power supply

100-240Vac ±10%, 50/60Hz, 3W

Relay output max loads (240Vac)

VII. e) TECHNICAL DATA CONT'D

INPUTS:				
Input Type		Terminal	Rating	
Power Supply		L – N	100-240 Vac, 50/60 Hz, Max. 5 W	
Digital Inputs		DI1, DI2	SELV 5 V, less than 15 W	
Probe		T1, T2	SELV 5 V, less than 15 W	
COMMUNICATION:				
Type/Function		Terminal	Rating	
Display		Remote (J5)	SELV 5 V, less than 15 W	
RS485		DATA (J6)	SELV 5 V, less than 15 W	
OUTPUTS(+):				
Output Terminals	Load Controlled	Switching Device and Schematic Ref	Electrical Ratings	Declaration
3 – 4	Compressor	RL1	Motor load 12 FLA 72 LRA, 240 Vac, 100k cycles	Type 1.B
			Resistive load 16 A, 240 Vac, 100k cycles	
7 – 8	Defrost Heater	RL2	Motor load 4 FLA 4 LRA, 240 Vac, 30k cycles	Type 1.B
			Resistive load 12 A, 240 Vac, 100k cycles	
9 – 12	Evaporator Fan	SSR1	Motor load (Declared specific load) 2.6 A, 240 Vac	--
10 – 11	Lights	SSR2	Inductive load 1.3 A, 240 Vac	--
Max. ampacity on the common terminal: 20 A				

PAR	RANGE	DESCRIPTION
SPL	-58..SPH	Minimum limit for SP setting.
SPH	SPL...180°	Maximum limit for SP setting.
SP	SPL... SPH	Setpoint (value to be maintained in the room).
C-H	REF; HEA	Refrigerating (REF) or Heating (HEA) control mode.
HY0	1...10°	Thermostat OFF -> ON differential.
HY1	0...10°	Thermostat ON -> OFF differential.
CRT	0...30min	Compressor rest time. The output is switched on again after CRT minutes have elapsed since the previous switchover. We recommend to set CRT=03 with HY0<2.0°.
CT1	0...30min	Compressor/Heater output run when probe T1 is faulty. With CT1=0 the output will always remain OFF.
CT2	0...30min	Compressor/Heater output stop when probe T1 is faulty. With CT2=0 and CT1>0 the output will always be ON. Example: CT1=4, CT2= 6: In case of probe T1 failure, the compressor will cycle 4 minutes ON and 6 minutes OFF.
DFM	NON; TIM; FRO CRN	Defrost start mode NON : defrost function is disabled (the following parameter will be FCM). TIM : regular time defrost. FRO : the defrost time count is only increased when the conditions occur for frost to form on the evaporator (optimized time increase). CRN : defrost is based off of compressor run time (time is based off of DAT).
DFT	0...250	Time interval among defrosts in x10 minutes. When this time has elapsed since the last defrost, a new defrost cycle is started. Each number is multiplied by 10 minutes. 0-250 indicates 0-2500 minutes.
DAT	0...100hrs	Frost accumulation timeout.
DFB	NO/YES	Defrost timer backup. With DFB=YES, after a power interruption, the timer resumes the count from where it was left off with ±30 min. approximation. With DFB=NO, after a power interruption, the defrost timer will re-start to count from zero.
DLI	-58...180°	Defrost end temperature.
DMD	0...30min	Minimum defrost duration.
DTO	1...120min	Maximum defrost duration.



PAR	RANGE	DESCRIPTION
DTY	OFF; ELE; GAS	Defrost type OFF: off cycle defrost (Compressor and Heater OFF). ELE: electric defrost (Compressor OFF and Heater ON). GAS: hot gas defrost (Compressor and Heater ON).
DSO	OFF; LO; HI	Defrost start optimization OFF : no optimization. LO : defrost waits until the compressor cut-out. HI : defrost waits until the compressor cut-in.
SOD	0...30 min	Start optimization delay.
DPD	0...240sec	Evaporator pump down. At the beginning of defrost, defrost outputs (determined by DTY) are OFF for DPD seconds.
DRN	0...30min	Pause after defrost (evaporator drain down time).
DDM	RT; LT; SP; DEF	Defrost display mode. During defrost the display will show: RT: the real temperature; LT : the last temperature before defrost; SP : the current setpoint value; DEF : "dEF".
DDY	0...60min	Display delay. The display shows the information selected with parameter DDM during defrost and for DDY minutes after defrost termination.
FID	NO/YES	Fans active during defrost.
FDD	-58...180°	Evaporator fan re-start temperature after defrost.
FTO	0...120min	Maximum evaporator fan stop after defrost.
FCM	NON; TMP; TIM	Fan mode during thermostatic control. NON : The fans remain ON all the time; TMP : Temperature-based control. The fans are ON when the compressor is ON. When the compressor is turned OFF, the fans remain ON as long as the temperature difference $T_e - T_a$ is greater than FDT. The fans are turned ON again with FDH differential. ( $T_e$ = Evaporator temperature, $T_a$ = Air temperature); TIM : Timed-based control. The fans are ON when the compressor is ON. When the compressor is OFF, the fans switch ON and OFF according to parameters FT1, FT2, FT3
FDT	-12...0°	Evaporator-Air temperature difference for the fans to turn OFF after the compressor has stopped.
FDH	1...12°	Temperature differential for fan re-start.  Example: FDT = -1, FDH=3. In this case, after the compressor has stopped, the fans are OFF when $T_e > T_a - 1$ (FDT), whereas the fans are ON when $T_e < T_a - 4$ (FDT-FDH).
FT1	0...180sec	Fan stop delay after compressor/heater stop. See Fig. 2
FT2	0...180	Timed fan stop in x10 seconds. With FT2=0 the fans remain on all the time.
FT3	0...180	Timed fan run in x10 seconds. With FT3=0, and FT2 > 0, the fans remain off all the time.
ATM	NON; ABS; REL	Alarm threshold management. NON : all temperature alarms are inhibited (the following parameter will be ACC). ABS : the values programmed in ALA and AHA represent the real alarm thresholds. REL : the alarm threshold is obtained by the sum of setpoint, thermostat differential and ALR/AHR.
ALA	-58... 180°	Low temperature alarm threshold.
AHA	-58... 180°	High temperature alarm threshold.
ALR	-12... 0°	Low temperature alarm differential. With ALR=0 the low temperature alarm is excluded.
AHR	0... 12°	High temperature alarm differential. With AHR=0 the high temperature alarm is excluded.
ATI	T1; T2; T3	Probe used for temperature alarm detection.
ATD	0... 120 min	Delay before alarm temperature warning.





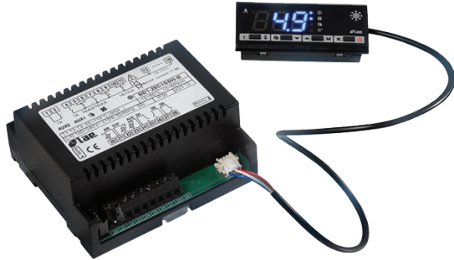

PAR	RANGE	DESCRIPTION
ACC	0...52 weeks	Condenser periodic cleaning. When the compressor operation time, expressed in weeks, matches the ACC value programmed, "CL" flashes in the display. With ACC=0 the condenser cleaning warning is disabled and CND disappears from Info Menu.
IISM	NON; MAN; ECO; DI	Switchover mode to second parameter set NON : inhibition to use the second parameter group (the following parameter will be SB). MAN : button switches the two parameter groups over. ECO : automatic switchover to the second parameter group, when ECO conditions are detected. DI : switchover to the second parameter group when DIx input is on.
IISL	-58... IISH	Minimum limit for IISP setting.
IISH	IISL... 180°	Maximum limit for IISP setting.
IISP	IISL... IISH	Setpoint in mode 2.
IIH0	1... 10°	Thermostat OFF->ON differential in mode 2.
IIH1	0... 10°	Thermostat ON->OFF differential in mode 2.
IIDF	0...250	Time interval among defrosts in mode 2 in x10 minutes.
IIFC	NON; TMP; TIM	Fan control in mode 2. See FCM.
ECS	1...5	Controller sensitivity for the automatic switchover from Group I to Group II (1=minimum, 5=maximum).
ECS	1...5	Controller sensitivity for the automatic switchover.
EPT	0...240 min	Eco pull-down time. Only with IISM=ECO. Group I parameters are used in regulation for at least EPT minutes. See Fig.3
SB	NO/YES	Stand-by button enabling.
DSM	NON; ALR; STP	Door switch input mode: NON : door switch inhibited ALR : when DIx=DOR and the digital input is on, an alarm is generated after ADO minutes STP : when DIx=DOR and the digital input is on, in addition to the alarm, the fans are immediately stopped and the compressor is stopped after CSD minutes.
DAD	0...30 min	Delay before door open alarm warning.
CSD	0...30 min	Compressor/heater stop delay after door has been opened.
D10	NON; DOR; ALR; IISM; RDS	DI1 digital input operation NON : digital input 1 not active. DOR : door input. ALR : when the input is on, an alarm is generated (if AHM=STP, the compressor is stopped and the defrosts are suspended). IISM : when the input is on, the controller will use group 2 parameters. RDS : when the input is on, a defrost is started (remote control).
D1A	OPN; CLS.	DI1 digital input activation. OPN : on open CLS : on close
D20	See D10	DI2 digital input operation. See D10.
D2A	OPN; CLS.	DI2 digital input activation. OPN : on open CLS : on close
PSL	-58...158	Minimum setpoint adjusted via potentiometer.
PSR	0...15	Range of setpoint adjusted via potentiometer.
LSM	NON; MAN; ECO; DI1; DI2; DI3.	Light control mode NON : light output not controlled. MAN : light output controlled through button (if OAx=LGT). ECO : lights activated/deactivated following the ECO state. DIx : lights activated/deactivated following the DIx state.

PAR	RANGE	DESCRIPTION
LSA	OPN; CLS	Light activation (only with LSM=ECO or LSM=Dlx). OPN : lights on with Dlx open or ECO mode deactivated. CLS : lights on with Dlx closed or ECO mode activated.
OT1	0...600 sec	Activation time of OA1
OT2	0...600 sec	Pause between OA1 activation
OA1	NON; LGT; 0-1; 2CU; 2EU; ALO; ALC	AUX 1 output operation NON : output disabled (always off). LGT : output enabled for light control. 0-1 : the relay contacts follow the on/standby state of controller. 2CU : output programmed for the control of an auxiliary compressor. 2EU : output enabled for the control of the electrical defrost of a second evaporator. ALO : contacts open when an alarm condition occurs. ALC : contacts make when an alarm condition occurs.
2CD	0...120 sec	Auxiliary compressor start delay. If OAx=2CU the auxiliary output is switched on with a delay of 2CD seconds after the main compressor has cut-in. Both compressors are turned off at the same time.
OS1	-12.5..12.5°	Probe T1 offset.
T2	NO/YES	Probe T2 enabling (evaporator).
OS2	-12.5..12.5°	Probe T2 offset.
T3	NON; DSP; CND; 2EU	Auxiliary probe T3 operation NON : probe T3 not fitted. DSP : temperature T3 to be displayed. CND : condenser temperature measurement. 2EU : second evaporator temperature measurement.
OS3	-12.5..12.5°	Probe 3 offset.
AHM	NON; ALR; STP;	Operation in case of high condenser alarm NON : high condenser alarm inhibited. ALR : in case of alarm, "HC" flashes in the display and the buzzer is switched on. STP : in addition to the alarm symbols displayed, the compressor is stopped and defrosts are suspended.
AHT	-50...110°	Condensation temperature alarm (referred to T3 probe).
TLD	1...30 min	Delay for minimum temperature (TLO) and maximum temperature (THI) logging.
TDS	T1; 1-2; T3	Selects the temperature probe to be displayed. T1 : probe T1 1-2 : the AVG-weighted average between T1 and T2    T3 : probe T3
AVG	0...100%	The relative weight of T2 on T1 (if TDS = 1-2) Example 1: T1 = -5°, T2 = -20°, AVG = 100%. The displayed temperature will be -20° (T1 has no effect) Example 2: T1 = -5°, T2 = -20°, AVG = 60%. The displayed temperature will be -14.
SCL	1°C; 2°C; °F	Readout scale. 1°C : measuring range -50...110°C (0.1°C resolution within -9.9 ÷ 19.9°C interval, 1°C outside) 2°C : measuring range -50 ... 110°C    °F : measuring range -55 ... 180°F
SIM	0...100	Display slowdown.
ADR	1...255	TRL-002 address for PC communication.
NPR	0...1	Setup programmed.
STT	0...255	Setup traceability.

## VII. f) COMPONENTS & WIRING DIAGRAM



### Indications:

-  Thermostat output
-  Fan output
-  Defrost output
-  Activation of 2<sup>nd</sup> parameter set
-  Alarm
-  Manual activation / Increase button
-  Exit / Stand-by button

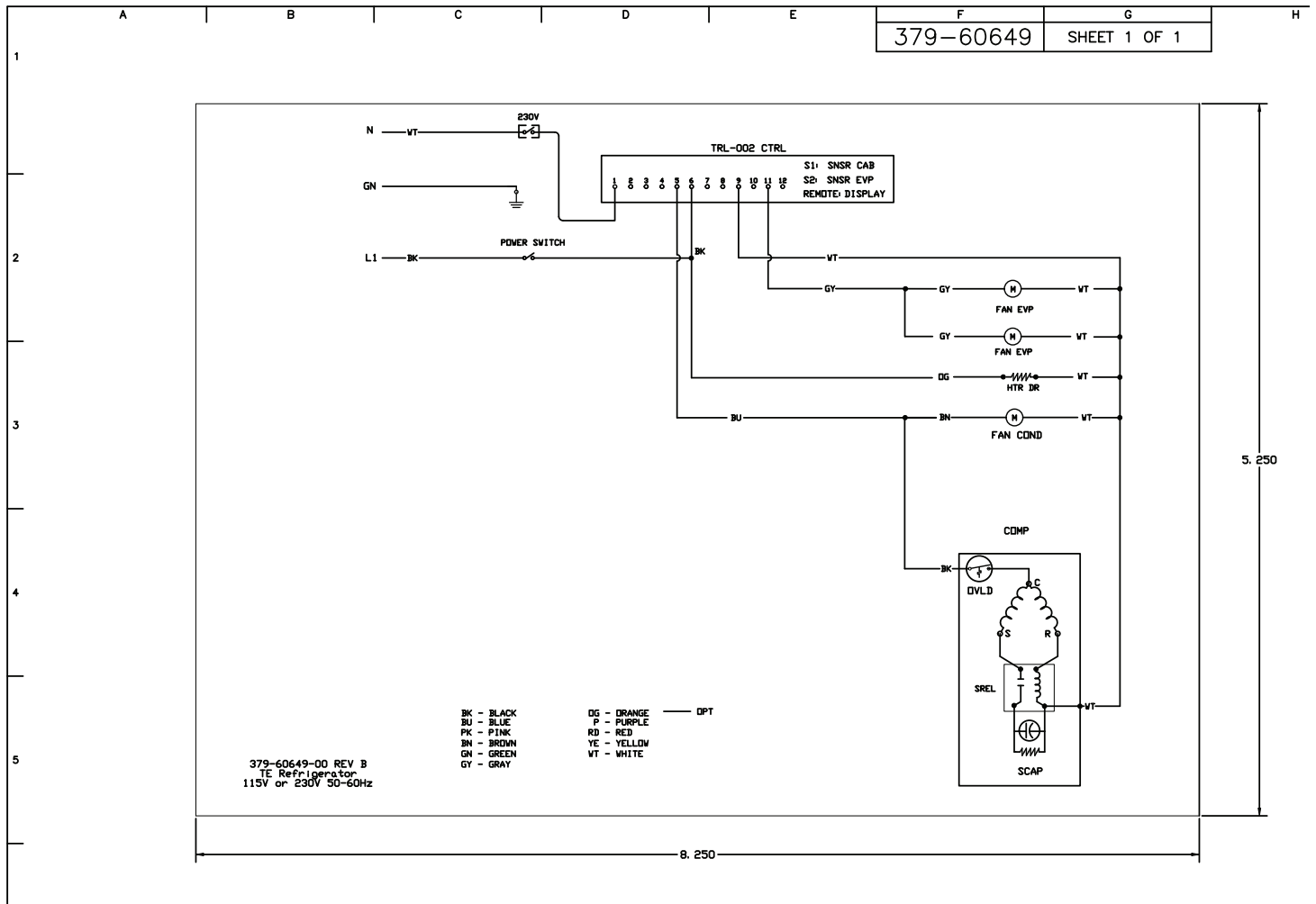

## Refrigerator Models



## VII. f) COMPONENTS & WIRING DIAGRAM CONT'D

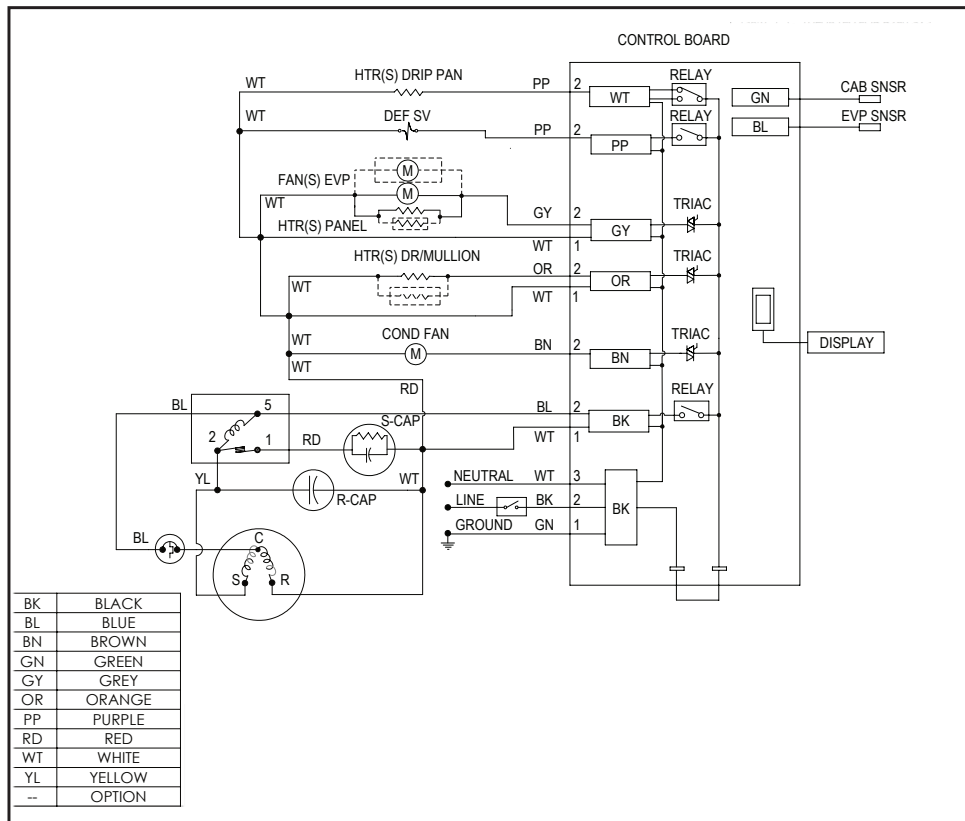

### Freezer Models

## VIII. TROUBLESHOOTING GUIDE

FIND YOUR PROBLEM HERE	REMEDY
1. Condensing unit fails to start.	a. Check if cord & plug has been disconnected. b. Check control temperature setting.
2. Condensing unit operates for prolonged periods or continuously.	a. Are drawers closing properly? b. Dirty condenser or filter. Clean properly. c. Evaporator coil iced. Needs to defrost. See instructions for setting a manual defrost cycle in section VII. c)
3. Food compartment is too warm.	a. Check drawer(s) and gasket(s) for proper seal b. Perhaps a large quantity of warm food has recently been added or the drawers were kept open for a long period of time, in both cases, allow adequate time for the cabinet to recover its normal operating temperature. c. Control setting too high, readjust per instructions on section VII. b) d. Check that condensing coil is clean.
4. Food compartment is too cold.	a. Perhaps a large quantity of very cold or frozen food has recently been added. Allow adequate time for the cabinet to recover its normal operating temperature. b. Adjust the control to a warmer setting, see section VII. b)
5. Condensation on the exterior surface.	a. Check drawer alignment and gaskets for proper seal. b. Condensation on the exterior surface of the unit is perfectly normal during periods of high humidity.
6. Compressor hums but does not start.	a. Call for service.
7. No power to unit	a. Check if cord & plug has been disconnected. b. Check power supply breaker.

## IX. SERVICE/WARRANTY INFORMATION

### IX. a) SERVICE INFORMATION

Before calling for service, please check the following:

Is the electrical cord plugged in?

Is the fuse OK or circuit breaker on?

Is the condenser coil clean?

Is the power switch on?

If after checking the above items and the unit is still not operating properly, please contact an authorized Traulsen service agent:

4401 Blue Mound Road Fort Worth, TX 76106

(800) 825-8220.

Traulsen reserves the right to change specifications or discontinue models without notice.



This appliance is marked with the ISO 7010-W021 warning label to indicate the presence of **FLAMMABLE REFRIGERANTS**. Prior to beginning work on systems containing **FLAMMABLE REFRIGERANTS**, safety checks are necessary to ensure that the risk of ignition is minimized.

### **VENTILATED AREA**

Ensure that the area is in the open or that it is adequately ventilated before breaking into the system or conducting any hot work. A degree of ventilation shall continue during the period that the work is carried out. The ventilation should safely disperse any released refrigerant and preferably expel it externally into the atmosphere.

### **CABLING**

Check that cabling will not be subject to wear, corrosion, excessive pressure, vibration, sharp edges, or any other adverse environmental effects. The check shall also take into account the effects of aging or continual vibration from sources such as compressors or fans.

### **DETECTION OF FLAMMABLE REFRIGERANTS**

Under no circumstances shall potential sources of ignition be used in the searching for or detection of refrigerant leaks. A halide torch (or any other detector using a naked flame) shall not be used.

The following leak detection methods are deemed acceptable for all refrigerant systems. Electronic leak detectors may be used to detect refrigerant leaks but, in the case of **FLAMMABLE REFRIGERANTS**, the sensitivity might not be adequate, or might need recalibration. (Detection equipment shall be calibrated in a refrigerant-free area.) Ensure that the detector is not a potential source of ignition and is suitable for the refrigerant used. Leak detection equipment shall be set at a percentage of the LFL of the refrigerant and shall be calibrated to the refrigerant employed, and the appropriate percentage of gas (25 % maximum) is confirmed.

Leak detection fluids are also suitable for use with most refrigerants but the use of detergents containing chlorine shall be avoided as the chlorine can react with the refrigerant and corrode the copper pipe-work.

IX. a) SERVICE INFORMATION CONT'D

**NOTE:** Examples of leak detection fluids are

- bubble method
- fluorescent method agents

**If a leak is suspected, all naked flames shall be removed/extinguished.**

If a leakage of refrigerant is found which requires brazing, all of the refrigerant shall be recovered from the system, or isolated (by means of shut off valves) in a part of the system remote from the leak. Removal of refrigerant shall be according to the removal & evacuation section below.

**REMOVAL & EVACUATION**

When breaking into the refrigerant circuit to make repairs- or for any other purpose - conventional procedures shall be used. However, for flammable refrigerants it is important that best practice be followed, since flammability is a consideration. The following procedure shall be adhered to:

- safely remove refrigerant following local and national regulations;
- purge the circuit with inert gas;
- evacuate
- purge with inert gas;
- open the circuit by cutting or brazing.

The refrigerant charge shall be recovered into the correct recovery cylinders if venting is not allowed by local and national codes. For appliances containing flammable refrigerants, the system shall be purged with oxygen- free nitrogen to render the appliance safe for flammable refrigerants. This process might need to be repeated several times. Compressed air or oxygen shall not be used for purging refrigerant systems .

For appliances containing flammable refrigerants, refrigerants purging shall be achieved by breaking the vacuum in the system with oxygen-free nitrogen and continuing to fill until the working pressure is achieved, then venting to atmosphere, and finally pulling down to a vacuum. This process shall be repeated until no refrigerant is within the system (optional for A2L). When the final oxygen-free nitrogen charge is used, the system shall be vented down to atmospheric pressure to enable work to take place.

Ensure that the outlet for the vacuum pump is not close to any potential ignition sources and that ventilation is available.

IX. b) SPARE PARTS INFORMATION

To purchase replacement parts or to speak to service support for Traulsen units please contact our Ft. Worth facility by phone at 800-825-8220 or fax to 817-740-6748 (parts) or 817-740-6757 (service).

Note: When calling for spare parts or service support, please make sure you have model and serial number of unit available.

**Model Number**

**Serial Number**

TRAULSEN		4102 Star, Houston Rd. Ft. Worth, TX 76106 800-825-8220	
MODEL NUMBER	807233001-710	QR CODE	
S/N	75260454		
REFRIGERANT / REFRIGERANTS / REFRIGERANT			
TYPE (R600a)	By Code	Weight	2.60 Lb (1.18 Kg)
Hi Press. (PSI/Bar)	Coldest	3.45 MPa (5.05 MPa)	
Lo Press. (PSI/Bar)	25.0 psi	1.72 MPa (2.49 MPa)	
TYPE (R600a)	In Unit	12.5 Lb	5.67 Kg (12.5 Lb)
Hi Press. (PSI/Bar)	Coldest	3.45 MPa (5.05 MPa)	
Lo Press. (PSI/Bar)	25.0 psi	1.72 MPa (2.49 MPa)	
Input Power (W/VA) - FOR INDOOR USE ONLY			
115 2000 500 - 5000 6.0 A 15.0 VA			
Component 1 (See Safety / Other Et)	Component 2 (See Safety / Other Et)	Component 3 (See Safety / Other Et)	Component 4 (None)
Component 5 (None)	Component 6 (None)	Component 7 (None)	Component 8 (See Safety / Other Et)
Product/Part Number (Part/Kit)		EUA/NEP (None)	
COMPONENTS / COMPONENTS / COMPONENTS			
COMP. NAME	UNIT NAME		
COND. TAN. AMP.	COND. WATT.		
REF. APT. AMP.	REF. WATT.		
COND. TAN. AMP.	COND. WATT.		
REF. APT. AMP.	REF. WATT.		

IX. c) WARRANTY REGISTRATION

The warranties for your new Traulsen unit may be registered with us by completing warranty information online, via our website [www.Traulsen.com](http://www.Traulsen.com). Click on the Warranty Registration text of the Service tab at the top of the home page. You may also register your product by calling us directly at 800-825-8220.



## NOTES



4401 Blue Mound Road Fort Worth, Texas 76106 (USA)

Phone: 800.825.8220 | Service Fax: 817.740.6757 | E-mail: [service@traulsen.com](mailto:service@traulsen.com) | Website: [traulsen.com](http://traulsen.com)

Form Number: TR36068 | Part Number: 375-60293-00 | Revision Date: 05/25

Traulsen © All Rights Reserved

