

®

DRAPER

INSTRUCTIONS FOR

Petrol Water Pumps

Stock No.64065
Stock No.24580**Part No.PWP52**
Part No.PWP81

MACHINE SHIPPED WITH NO OIL, ADD OIL BEFORE TRYING TO START THIS MACHINE.
IMPORTANT: PLEASE READ THESE INSTRUCTIONS CAREFULLY TO ENSURE THE SAFE AND EFFECTIVE USE OF THIS PRODUCT.



CE

24580 Shown

DRAPER®

GENERAL INFORMATION

These instructions accompanying the product are the original instructions. This document is part of the product, keep it for the life of the product passing it on to any subsequent holder of the product. Read all these instructions before assembling, operating or maintaining this product.

This manual has been compiled by Draper Tools describing the purpose for which the product has been designed, and contains all the necessary information to ensure its correct and safe use. By following all the general safety instructions contained in this manual, it will ensure both product and operator safety, together with longer life of the product itself. All photographs and drawings in this manual are supplied by Draper Tools to help illustrate the operation of the product. Whilst every effort has been made to ensure the accuracy of information contained in this manual, the Draper Tools policy of continuous improvement determines the right to make modifications without prior warning.

1. TITLE PAGE

1.1 INTRODUCTION:

USER MANUAL FOR:

PETROL WATER PUMPS

Stock no. 64065, 24580.

Part no. PWP52, PWP81.

1.2 REVISIONS:

Date first published December 2016.

As our user manuals are continually updated, users should make sure that they use the very latest version.

Downloads are available from: <http://www.drapertools.com/b2c/b2cmanuals.pgm>

DRAPER TOOLS LIMITED

HURSLEY ROAD

CHANDLER'S FORD

EASTLEIGH

HAMPSHIRE

SO53 1YF

UK

WEBSITE: drapertools.com

PRODUCT HELPLINE: +44 (0) 23 8049 4344

GENERAL FAX: +44 (0) 23 8026 0784

1.3 UNDERSTANDING THIS MANUALS SAFETY CONTENT:

WARNING! Information that draws attention to the risk of injury or death.

CAUTION! Information that draws attention to the risk of damage to the product or surroundings.

NOTE! Important information.

1.4 COPYRIGHT © NOTICE:

Copyright © Draper Tools Limited.

Permission is granted to reproduce this publication for personal & educational use only.

Commercial copying, redistribution, hiring or lending is prohibited.

No part of this publication may be stored in a retrieval system or transmitted in any other form or means without written permission from Draper Tools Limited.

In all cases this copyright notice must remain intact.

2. CONTENTS

2.1 CONTENTS

Page content		Page
1	TITLE PAGE	
	1.1 INTRODUCTION	2
	1.2 REVISION HISTORY	2
	1.3 UNDERSTANDING THIS MANUAL	2
	1.4 COPYRIGHT NOTICE	2
2	CONTENTS	
	2.1 CONTENTS	3
3	GUARANTEE	
	3.1 GUARANTEE	4
4	INTRODUCTION	
	4.1 SCOPE	5
	4.2 SPECIFICATION	5
	4.3 HANDLING & STORAGE	5
5	HEALTH & SAFETY INFORMATION	
	5.1 GENERAL SAFETY INSTRUCTIONS	6-7
6	TECHNICAL DESCRIPTION	
	6.1 IDENTIFICATION	8
7	UNPACKING & CHECKING	
	7.1 PACKAGING	9
	7.2 WHAT'S IN THE BOX	9
8	PREPARING THE WATER PUMP	
	8.1 HOSE CONNECTION	10
9	SETTING THE WATER PUMP	
	9.1 PREPARING THE PUMP	11
	9.2 FUELLING	11
	9.3 CHECKING THE ENGINE OIL	12
10	BASIC WATER PUMP OPERATION	
	10.1 PRIMING THE PUMP	13
	10.2 CLEANING OUT BLOCKAGE	13
	10.3 STARTING THE MACHINE	14
	10.4 STOPPING THE MACHINE	14
11	MAINTENANCE	
	11.1 AFTER THE FIRST 20 HOURS OPERATION	15
	11.2 EVERY 50 HOURS OPERATION	15
	11.3 PERIODIC MAINTENANCE	16
	11.4 RISK OF FIRE	17
	11.5 RISK OF INJURY AND PROPERTY DAMAGE WHEN TRANSPORTING WATER PUMP	18
	11.6 RISK OF BREATHING - INHALATION HAZARD	18
	11.7 RISK OF UNSAFE OPERATION	18
	11.8 RISK OF HOT SURFACES	18
	11.9 RISK OF MOVING PARTS	19
	11.10 RISK FROM LIFTING	19
12	OPTIONAL ACCESSORIES	
	12.1 DRAPER SUCTION HOSES	20
	12.2 DRAPER HOSE CLAMPS	20
	12.3 DRAPER FOOT/NON RETURN VALVES	20
13	TROUBLE SHOOTING	21
14	EXPLANATION OF SYMBOLS	
	14.1 EXPLANATION OF SYMBOLS	22
15	DISPOSAL	
	15.1 DISPOSAL	23
	DECLARATION OF CONFORMITY	ENCLOSED

3. GUARANTEE

3.1 GUARANTEE

Draper tools have been carefully tested and inspected before shipment and are guaranteed to be free from defective materials and workmanship for a period of 12 months from the date of purchase except where tools are hired out when the guarantee period is ninety days from the date of purchase.

A proof of purchase must be provided with the tool.

Should the machine develop any fault, please return the complete tool to your nearest authorized warranty repair agent or contact Draper Tools Limited, Chandler's Ford, Eastleigh, Hampshire, SO53 1YF. England. Telephone Sales Desk: (023) 8049 4333 or Product Helpline (023) 8049 4344.

If upon inspection it is found that the fault occurring is due to defective materials or workmanship, repairs will be carried out free of charge. This guarantee does not apply to normal wear and tear, nor does it cover any damage caused by misuse, careless or unsafe handling, alterations, accident, or repairs attempted or made by any personnel other than the authorised Draper warranty repair agent.

NOTE: If the tool is found not to be within the terms of warranty, repairs and carriage charges will be quoted and made accordingly.

This guarantee applies in lieu of any other guarantee expressed or implied and variations of its terms are not authorised.

Your Draper guarantee is not effective unless you can produce upon request a dated receipt or invoice to verify your proof of purchase within the 12 month period.

Please note that this guarantee is an additional benefit and does not affect your statutory rights.

Draper Tools Limited

4. INTRODUCTION

4.1 SCOPE

Ideal for building sites and agricultural applications where mains power is not available.

4.2 SPECIFICATION

The Draper Tools policy of continuous improvement determines the right to change specification without notice.

Stock no.	64065	24580
Part no.	PWP52	PWP81
Engine.....	4.8HP 4 stroke	7HP 4 stroke
Suction aperture.....	50mm(2")	80mm(3")
Output aperture.....	50mm(2")	80mm(3")
Max. flow.....	500L/min	1000L/min
Max head height.....	25M	30M
Max suction head height.....	8M	7M
Application	Clean water	Clean water
Weight (net.)	26kg	28.5kg

4.3 HANDLING & STORAGE

CAUTION: Always use and store this water pump correctly, never use or store this pump on its side as oil or fuel may leak and damage the pump or your property.

If the pump has been used always allow it to cool for at least 30 minutes before transporting the pump and ensure that the pump has fully cooled before returning it to storage as a hot engine and exhaust system could cause personal injury or ignite some materials.

To prevent fuel/oil spillage when transporting, the pump should be secured upright in its normal operating position with the engine switch in the off position.

Take care not to drop or strike the pump when transporting. Never cover the pump when in use.

Before storing the pump for a long period:-

1. Be sure that the storage area is free of excessive humidity and dust.
2. Drain the fuel, storage procedure below.
 - A. Unscrew the fuel tank cap, remove the filter screen and empty the fuel tank into an approved petrol container using a commercially available hand siphon (Draper Stock No.43650), re-install the filter screen and fuel tank cap.
 - B. Loosen the carburettor drain screw and drain the carburettor into a suitable container.
 - C. Remove the spark plug maintenance cover and remove the spark plug cap.
 - D. Turn the engine switch to the OFF position.
 - E. Pull the starter cord 3 or 4 times to empty the fuel pump of petrol, into a suitable container.
 - F. Turn the engine switch to the OFF position and tighten the carburettor drain screw.

5. HEALTH & SAFETY INFORMATION

5.1 GENERAL SAFETY INSTRUCTIONS

NOTE: Water pumps are designed to give safe and dependable service if operated according to instructions. Read and understand this owners manual fully before operating this pump. You can help prevent accidents by being familiar with the pump controls and by observing safe operating procedures.

OPERATOR RESPONSIBILITY

- Know how to stop the water pump quickly in case of emergency.
- Be sure that anyone who operates the water pump receives proper instruction in it's safe use.

WARNING!:

CARBON MONOXIDE HAZARDS

- Exhaust gases contain poisonous carbon monoxide, a colourless and odourless gas. Breathing carbon monoxide can cause loss of consciousness and may lead to death.

NEVER run this water pump in an enclosed space or partly enclosed space.

ALWAYS ensure a high level of ventilation in the area that you intend to use the water pump to avoid the potential build up of carbon monoxide.

WARNING!:

FIRE AND BURN HAZARDS

- The exhaust system gets hot enough to ignite some materials.
 - Keep the water pump at least 3 feet (1 metre) away from buildings and other equipment during operation.
 - Do not enclose the water pump in any structure.
 - Keep flammable materials away from the water pump.
- The muffler becomes very hot during operation and remains hot for a while after stopping the engine. Be careful not to touch the muffler while it is hot. Let the engine cool before storing the water pump indoors.
- Petrol is extremely flammable and is explosive under certain conditions. Do not smoke or allow flames or sparks where the water pump is refuelled or where petrol is stored. Refuel in a well-ventilated area with the engine stopped.
- Fuel vapours are extremely flammable and may ignite after the engine has started. Make sure that any spilled fuel has been wiped up before starting the water pump.

PUMP OPERATION

- Do not operate this product without being completely familiar on all safety aspects, functions and most importantly how to stop the engine in an emergency.
- Never use the pump if the stop switch is **FAULTY** or not functional.
- Do not use the pump indoors; fumes can kill. Only operate in a well ventilated area and at least 1M away from buildings.
- Never operate the pump without first priming it fully.

5. HEALTH & SAFETY INFORMATION

MAINTENANCE

- Never modify the pump in anyway.
- Always maintain the pump in good working order regularly serviced by an authorised service agent.
- Only use replacement parts supplied by the manufacturer.
- Only use fresh, clean and good quality fuel in the engine.
- Never operate the pump without oil.
- Never refuel in close proximity to naked flames, sparks or other sources of ignition, e.g. cigarettes.
- Allow the engine to cool before refuelling and avoid spillage while refuelling.
- Wipe up and correctly dispose of any fuel spillage immediately with a suitable medium.
- Move away from the refuelling areas before restarting the engine.
- Store fuel for short periods only. Store in a container specifically designed for petrochemical applications away from heat and direct sun light.
- After each use clean the pump thoroughly.
- Regularly check external nuts and fixings to ensure vibration caused by normal use has not begun to loosen them.

WARNING!:

DO NOT OPERATE THIS MACHINE IN ANY HAZARDOUS LOCATION

Such areas include when there is a risk of an explosion of petrol fumes, leaking gas or explosive dust.

CAUTION:

ENGINE SPEED HAS BEEN FACTORY SET TO PROVIDE SAFE OPERATION

Tampering with the engine speed adjustment could result in overheating of attachments and could cause a fire. Never attempt to "speed up" the engine to gain more performance as this will result in the output being thrown out of their standard design parameters, potentially endangering the user and causing irreversible damage to the water pump.

NOTE:

PROTECT YOUR WATER PUMP

This water pump is **NOT WEATHERPROOF** and should not be exposed to direct sunlight, high ambient temperatures and damp, wet or high humidity conditions.

6. TECHNICAL DESCRIPTION

6.1 IDENTIFICATION

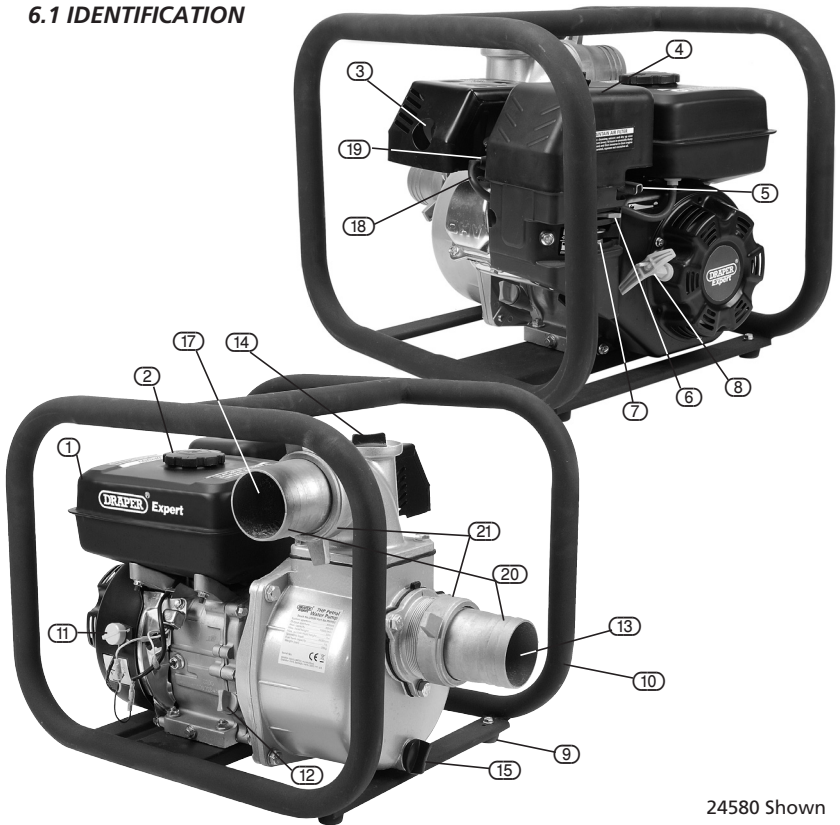

24580 Shown

- | | |
|------------------------------|----------------------|
| ① Fuel tank | ⑫ Oil level dipstick |
| ② Fuel tank cap | ⑬ Inlet [suction] |
| ③ Muffler [exhaust] | ⑭ Priming opening |
| ④ Air filter housing | ⑮ Drain |
| ⑤ Throttle lever | ⑯ Outlet |
| ⑥ Choke lever | ⑰ HT lead |
| ⑦ Fuel lever | ⑱ Spark plug cap |
| ⑧ Recoil [pull] start handle | ⑳ Hose barb |
| ⑨ Anti vibration feet | ㉑ Hose barb coupling |
| ⑩ Frame | |
| ⑪ Main engine switch | |

7. UNPACKING & CHECKING

7.1 PACKAGING

Carefully remove the water pump from the packaging and examine it for any sign of damage that may have happened during shipping. Lay the contents out and check them against the parts shown below. If any part is damaged or missing; please contact the Draper Helpline (the telephone number appears on the Title page) and do not attempt to use the water pump.

The packaging material should be retained at least during the guarantee period: in case the machine needs to be returned for repair.

Warning! Some of the packaging materials used may be harmful to children. Do not leave any of these materials in the reach of children.

If any of the packaging is to be thrown away, make sure they are disposed of correctly; according to local regulations.

7.2 WHAT'S IN THE BOX?

As well as the water pump; there are several parts not fitted or attached to it.

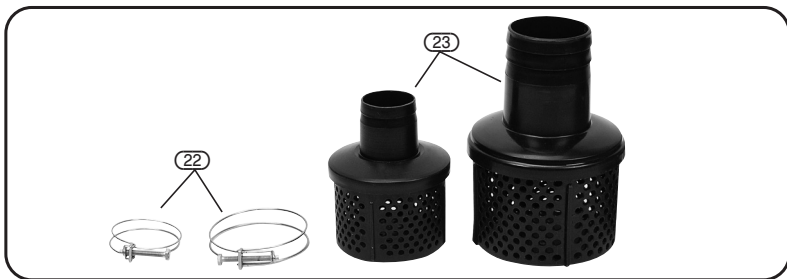

(22) Hose clamps x2 (size specific for model purchased)

(23) Strain filter (clean water 24578, 24580) 1 supplied, size specific to model ordered

8. PREPARING THE WATER PUMP

8.1 HOSE CONNECTION - FIGS. 1 - 2

To stop the hose collapsing on the suction side of the pump; a solid wall (reinforced) hose must be used. Please see optional accessories section for recommended suction hose.

- i. Unscrew hose barb coupling (21) from the pump body.
- ii. Slide the hose barb coupling over the hose barb (20) and attach the coupling to the pump.
- iii. Slide hose clamp (22) over the solid wall hose before pushing the hose onto hose barb (20); making certain it has gone over all the way.
- iv. Use the hose clamp to grip the hose securely onto the connector. Make certain the clamp is central on the connector.

NOTE: Clamp the strain filter to the other end of the suction hose. This helps avoid larger pieces of debris being sucked through the pump and causing damage.

Fig.3 Clean water filters 24578, 24580.

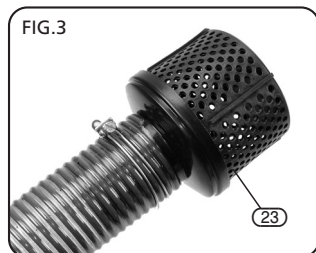
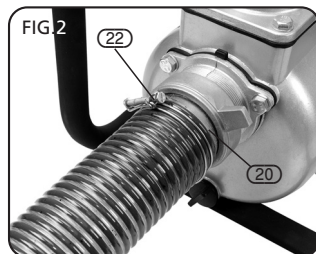
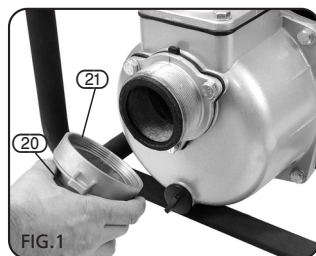

9. SETTING THE WATER PUMP

9.1 PREPARING THE PUMP - FIGS. 3 - 6

It is important to check the pump before you commence operating the unit.

IMPORTANT: Ensure that the engine has oil. When leaving the factory, this water pump has **NO OIL** in the engine.

NOTE: The water pump has a low oil sensor and will not start if it has no oil (Fig.1).

9.2 FUELLING

Use unleaded petrol only.

1. Remove the petrol cap (2).
2. Ensure the fuel filter is in place - Do not pour fuel into the tank without the fuel filter (2.1) in place.
3. Do not over fill - leave air gap at top of fuel level.
4. Always screw down fuel cap.
5. Clean up any spilled fuel immediately.
6. Move water pump at least 12 feet (4M) away from the fuelling area before starting.

WARNING:

- Do not refill fuel tank while engine is running or is hot.
- Check to ensure that the petrol cap has been tightened and that fuel is not leaking.
- Be careful not to admit dust, dirt, water or other foreign objects into the fuel.
- Wipe off spilt fuel thoroughly before starting engine.
- Ensure you **DO NOT** fuel the pump in close proximity to any open flames.



9. SETTING THE WATER PUMP

9.3 CHECKING THE ENGINE OIL - FIGS. 7 - 8

The motor of this pump is not filled with oil.

Prior to starting the motor ensure the crank case is filled with SAE #30 4 stroke oil.

Damage to the motor is not covered under warranty if the motor is run without oil.

1. Before checking or refilling oil, be sure the pump is put on a stable and level surface, ensuring the engine has been switched OFF.
2. Remove the oil filter cap (12) by rotating the cap anti-clockwise and inspect to see the oil level (Fig.6).
3. If the oil level is below the lower level line, refill with SAE #30 4 stroke oil to the upper level line.
NOTE: Do not screw in the oil filter cap (12) when checking oil level, simply insert and pull the cap straight out.
4. If the oil is contaminated or has discoloured, ensure you change the oil. Refer to the 'Engine oil replacement' section for instructions.

NOTE: This motor is fitted with a low oil sensor. If the oil level is too low the motor will stop operating or the motor will not start. It is advised to check the oil level each time the pump is used.

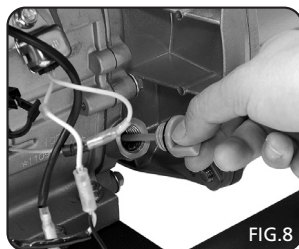
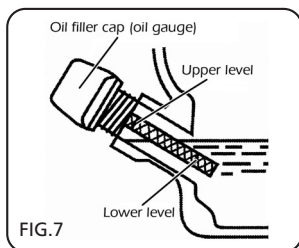

10. BASIC WATER PUMP OPERATION

10.1 PRIMING THE PUMP - FIG. 9

CAUTION!: Never use the pump without priming it first.

It is necessary to prime the pump before use. You must first fill the impeller housing with water before you connect the top outlet hose. This will allow the pump to create a low pressure vacuum that will draw the water up for pumping. Priming the pump is accomplished by firstly fitting a foot valve to the end of the suction hose that will be dropped into the water that you wish to be pumped away. A foot valve (see optional accessories on page 19) will ensure that the water cannot leak away from your filled suction hose back into the water source and hence your pump will not lose its prime. Ensure that the suction hose with foot valve fitted stays completely submerged during the pumping operation. With a foot valve fitted fill the hose up with water before you connect it to the pumps hose connection. Now you need to remove the priming cap (14) and fill the pump housing with water before re-fitting the cap and starting your pump.

Once your pump is started it may take a moment to complete its priming and this time will vary due to the length of the suction hose fitted ie: a longer suction hose will take longer to fully prime and start pumping water. Once the pump has fully primed it will draw the water from the water source and pump it out through the pumps outlet and into any lay flat hose that you have fitted to direct the pumped water to the desired location.

10.2 CLEANING OUT BLOCKAGE

Ensure the water pump is turned off before attempting to open the pump.

Remove the securing bolts to remove the impeller cover, clear any blockage and then re-fit ensuring a watertight seal.

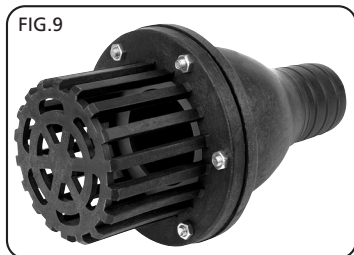
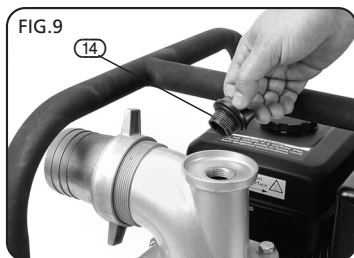

10. BASIC WATER PUMP OPERATION

10.3 STARTING THE MACHINE -

FIGS. 11 - 14

After all the instructions and warnings have been followed and observed the engine is ready to start.

- i. Slide the fuel lever (7) to the right; turning on the fuel supply.
- ii. Slide the throttle lever (5) to the left; opening the throttle a little.
- iii. Slide the choke lever (6) to the left; closing the choke to help with the initial start up.
- iv. Turn on the engine switch (11).
- v. Sharply pull the recoil start handle (8); do not let go of the handle. Let the recoil handle return slowly. Do not pull the rope out fully while trying to start the engine.

When the engine is running and has warmed up;

- i. Reopen the choke so that the engine runs smoothly.
- ii. Increase the throttle speed to being pumping.

NOTE: Whenever the pump is not in use, lower the idle or switch off the engine.

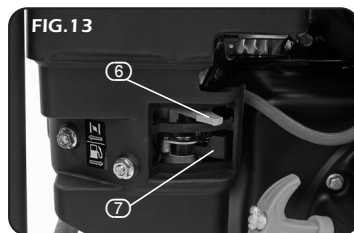
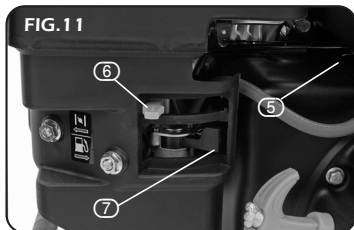

10.4 STOPPING THE MACHINE

Before stopping the engine, the throttle should be set to idle and the engine run for a couple of minutes.

- i. If the engine is only being stopped for a moment; slide the fuel lever to the left and turn the engine switch (11) off.
- ii. If the engine is being stopped and later stored; slide the fuel lever to the left and wait for the engine to cut-out from fuel starvation before turning the engine switch (11) off.

NOTE: In the event of an emergency, kill the engine with switch (11).

11. MAINTENANCE

Make sure that the pump is not running when carrying out maintenance work.

The 'Draper' water pump has been designed to operate over a long period of time.

Continuous satisfactory operation depends upon proper machine care, regular cleaning and by following the periodic maintenance schedule. If the pump is operating in unusually dusty or hot conditions the time between servicing the pump must be decreased.

Inspect the water pump and extension cables periodically and if damaged have them repaired by a qualified person or authorised service body. Do not use the pump with damaged parts.

11.1 AFTER THE FIRST 20 HOURS OPERATION - FIG. 15

CHANGE THE ENGINE OIL.

- Unscrew and remove the dipstick followed by the sump bolt (12.1). Catch the used oil in a suitable container and dispose of it in an approved manner.
- When all the oil has drained from the engine block, replace the sump bolt and refill the engine oil up to the maximum level.
- Oil grade SAE10W-30 or equivalent.

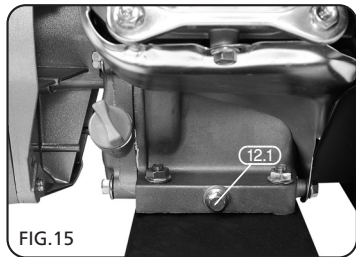

FIG. 15

11.2 EVERY 50 HOURS OPERATION - FIGS. 14 - 17

CHANGE THE AIR FILTER ELEMENT.

CAUTION: Do not run the engine without the air filter element in place.

- Unscrew the nut and remove the air filter housing (4).
- Clean the filter element (4.1) in paraffin. When dry soak the filter in clean engine oil.

Squeeze all the excess oil before refitting, and assembling the housing.



FIG. 16

SPARK PLUG INSPECTION

- Remove spark plug connection (19) by hand.
- Remove spark plug (19.1) with plug spanner provided.
- Inspect the spark plug. It should be a tan colour.
- Clean plug and adjust the gap 0.7 - 0.8mm.
- Replace the spark plug with correct torque: 20Nm (2m.kg 14 ftlb).
- Replace spark plug if required.

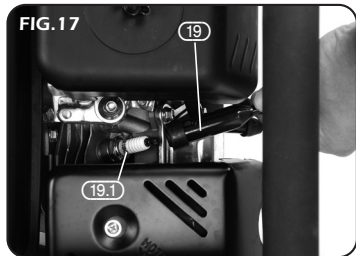

FIG. 17

11. MAINTENANCE

11.3 PERIODIC MAINTENANCE

Item	Remarks	Pre-operation check (daily)	Initial 1 month or 20Hrs	Every 3 months or 50Hrs	Every 6 months or 100Hrs	Every 12 months or 300Hrs
Spark plug	Check condition, adjust gap and clean. Replace if necessary.			•		
Engine oil	Check oil level.	•				
	Replace.		•		•	
Air filter	Clean. Replace if necessary.			•		
Fuel filter	Clean fuel drain filter. Replace if necessary.				•	
Valve clearance	Check and adjust when engine is cold.					•
Fuel line	Check fuel hose for crack or damage. Replace if necessary.	•				
Exhaust system	Check for leakage. Retighten or replace gasket if necessary.	•				
	Check muffler screen. Clean/replace if necessary.				•	
Carburettor	Check choke operation.	•				
Starting system	Check key start ignition operation.	•				
Decarbonisation	More frequently if necessary.					•
Fittings/ fasteners	Check all fittings and fasteners correct if necessary.				•	

Regular maintenance is most important for the best performance and safe operation.

11. MAINTENANCE

11.4 RISK OF FIRE

HAZARD	WHAT COULD HAPPEN	HOW TO PREVENT IT
Attempting to fill the fuel tank while the engine is running.	Fuel and fuel vapours can become ignited by coming in contact with hot components such as the muffler, engine exhaust gases, or from an electrical spark.	Turn engine off and allow it to cool before adding fuel to the tank. Equip area of operation with a fire extinguisher certified to handle gasoline or fuel fires.
Sparks, fire, hot objects	Cigarettes, sparks, fires, or other hot objects can cause fuel or fuel vapours to ignite.	Add fuel to tank in well ventilated area. Make sure there are no sources of ignition near the water pump.
Improper storage of fuel	Improperly stored fuel could lead to accidental ignition. Fuel improperly secured could get into the hands of children or other unqualified persons.	Store fuel in an approved container designed to hold fuel. Store container in secure location to prevent use by others.
Tampering with factory set engine speed settings.	Engine speed has been factory set to provide safe operation. Tampering with the engine speed adjustment could result in overheating of attachments and could cause a fire.	Never attempt to "speed-up" the engine to obtain more performance. Both the output voltage and frequency will be thrown out of standard by this practice, endangering attachments and the user.
Inadequate ventilation for water pump	Materials placed against or near the water pump or operating the water pump in areas where the temperature exceeds 40°C. ambient (such as storage rooms or garages) can interfere with its proper ventilation features causing overheating and possible ignition of the materials or buildings.	Operate water pump in a clean, dry, well ventilated area. DO NOT OPERATE UNIT INDOORS OR IN ANY CONFINED AREA.
Overfilling the fuel tank – fuel spillage.	Spilled fuel and its vapours can become ignited from hot surfaces or sparks.	Use care in filling the tank to avoid spilling fuel. Make sure fuel cap is secured tightly and check engine for fuel leaks before starting engine. Move water pump away from refuelling area or any spillage before starting engine. Allow for fuel expansion. Never refuel with the engine running.

11. MAINTENANCE

11.5 RISK OF INJURY AND PROPERTY DAMAGE WHEN TRANSPORTING WATER PUMP

HAZARD	WHAT COULD HAPPEN	HOW TO PREVENT IT
Fire, inhalation, damage to vehicle surfaces	Fuel or oil can leak or spill and could result in fire or breathing hazard, serious injury or death can result. Fuel or oil leaks can damage carpet, paint or other surfaces in vehicles or trailers.	The water pump is equipped with a fuel drain valve, turn the valve to the off position before transporting to avoid fuel leaks. Transport fuel only in an approved fuel container. Always place water pump on a protective mat when transporting to protect against damage to vehicle from leaks. Remove water pump from vehicle immediately upon arrival at your destination.

11.6 RISK OF BREATHING – INHALATION HAZARD

HAZARD	WHAT COULD HAPPEN	HOW TO PREVENT IT
Gasoline engines produce toxic carbon monoxide exhaust fumes.	Breathing exhaust fumes will cause serious injury or death.	Operate water pump in clean, dry, well ventilated area. Never operate unit in enclosed areas such as garages, basements, storage, sheds, or in any location occupied by humans or animals. Keep children, pets and others away from area of operating unit.

11.7 RISK OF UNSAFE OPERATION

HAZARD	WHAT COULD HAPPEN	HOW TO PREVENT IT
Operation of water pump in careless manner.	All sources of energy include the potential for injury. Unsafe operation or maintenance of your water pump could lead to serious injury or death to you or others.	<ul style="list-style-type: none">• Review and understand all of the operating instructions and warnings in this manual.• Become familiar with the operation and controls of the water pump. Know how to shut it off quickly.• Equip area of operation with a fire extinguisher certified to handle gasoline or fuel fires.• Keep children of others away from the water pump at all times.
Operating water pump while suspended	Water pump will not operate properly and will cause damage to the water pump and could cause serious injury or death to you or others.	Never operate water pump while suspended or in an unlevel position. Always operate generate on a flat, level surface.

11.8 RISK OF HOT SURFACES

HAZARD	WHAT COULD HAPPEN	HOW TO PREVENT IT
Contact with hot engine and water pump components.	Contact with hot surfaces, such as engines exhaust components, could result in serious burns.	During operation, touch only the control surfaces of the water pump. Keep children away from the water pump at all times. They may not be able to recognize the hazards of this product.

11. MAINTENANCE

11.9 RISK OF MOVING PARTS

HAZARD	WHAT COULD HAPPEN	HOW TO PREVENT IT
Contact with moving parts can result in serious injury.	The water pump contains parts which rotate at high speed during operation. These parts are covered by guarding to prevent injury.	Never operate water pump with guarding or cover plates removed. Avoid wearing loose fitting clothing or jewellery which could be caught by moving parts.

11.10 RISK FROM LIFTING

HAZARD	WHAT COULD HAPPEN	HOW TO PREVENT IT
Lifting a very heavy object.	Serious injury can result from attempting to lift too heavy an object.	When lifting, always keep the object you are lifting near the vertical axis of your body. DO NOT use you back to lift heavy loads. Both people should crouch down, grab the underside of unit and use your legs to carry the weight. Keep the object as near the centre of your body's gravity as possible. Avoid twisting your bodies when carrying the unit; instead, turn your whole body using your feet.

12. OPTIONAL ACCESSORIES

12.1 Draper suction hoses

Description	Stock No.	Part No.
2" suction hose	20470	APWP2
3" suction hose	20471	APWP3

12.2 Draper hose clamps

Description	Stock No.	Part No.
2" hose clamps x2	22599	ASHC2
3" hose clamps x2	22601	ASHC3

12.3 Draper foot/non return valves

Description	Stock No.	Part No.
2" Foot/Non return valve	19548	FVS2
3" Foot/Non return valve	19552	FVS3

13. TROUBLESHOOTING

PROBLEM	CAUSE	REMEDY
Engine does not start.	<ol style="list-style-type: none">1. Fuel.2. Spark3. Other	<ol style="list-style-type: none">1. Check fuel level, if low, refill.2. Remove plug and check spark.3. Contact an authorised service agent.
Pumping failure.	<ol style="list-style-type: none">1. Priming water.2. Strainer.3. Air suction.4. Other.	<ol style="list-style-type: none">1. Check water level, if low, refill.2. Strainer maybe clogged, check to unblock.3. Check hose clamps are securely fastened and make sure that there is no damage to the pumping hose.4. Contact an authorised service agent.

14. EXPLANATION OF SYMBOLS

14.1 EXPLANATION OF SYMBOLS



Do not use in the wet.



Warning!
Read the instruction manual



Caution!



For outdoor use only.
Do not expose to rain.



Danger!
Highly flammable liquid



Engine and exhaust
become hot during use;
do not touch.



WEEE
Do not dispose of Waste Electrical
& Electronic Equipment in with
domestic rubbish



Caution!
Risk of electric shock



Warning!
Wear ear defenders.

14. DISPOSAL

14.1 DISPOSAL

- At the end of the machine's working life, or when it can no longer be repaired, ensure that it is disposed of according to national regulations.
- Contact your local authority for details of collection schemes in your area.

In all circumstances:

- Do not dispose of power tools with domestic waste.
- Do not incinerate.
- Do not abandon in the environment.
- Do not dispose of WEEE* as unsorted municipal waste.



- **DRAPER TOOLS LIMITED,**
Hursley Road, Chandler's Ford,
Eastleigh, Hampshire. SO53 1YF. U.K.
- **Helpline:** (023) 8049 4344
- **Sales Desk:** (023) 8049 4333
- **Internet:** www.drapertools.com
- **E-mail:** sales@drapertools.com
- **Sales Fax:** (023) 8049 4209
- **General Enquiries:** (023) 8026 6355
- **Service/Warranty Repair Agent**
For aftersales servicing or warranty repairs, please contact the Draper Tools Helpline for details of an agent in your local area.

YOUR DRAPER STOCKIST