



Scan to see the online manual.



OWNER'S MANUAL

DRYER

Read this owner's manual thoroughly before operating the appliance and keep it handy for reference at all times.

ENGLISH

DLHC8402*



MFL69783898
Rev.00_020426

www.lg.com

Copyright © 2026 LG Electronics. All Rights Reserved

TABLE OF CONTENTS

3 IMPORTANT SAFETY INSTRUCTIONS

- 3 READ ALL INSTRUCTIONS BEFORE USE
- 3 WARNING STATEMENTS
- 6 CAUTION STATEMENTS

7 PRODUCT OVERVIEW

- 7 Product Features

11 INSTALLATION

- 11 Before Installing
- 12 Choosing the Proper Location
- 15 Leveling the Appliance
- 15 Reversing the Door
- 17 Connecting Electric Dryers
- 21 Connecting the Water Inlet Hose
- 22 Connecting the Drain Hose
- 23 Final Installation Check

24 OPERATION

- 24 Before Use
- 25 Loading the Dryer
- 27 Control Panel
- 29 Dry Cycles
- 34 Cycle Modifiers
- 35 Options and Extra Functions

37 SMART FUNCTIONS

- 37 LG ThinQ Application
- 40 Smart Diagnosis™ Function

41 MAINTENANCE

- 41 Regular Cleaning

45 TROUBLESHOOTING

- 45 FAQs
- 46 Before Calling for Service

51 LIMITED WARRANTY

- 51 USA

IMPORTANT SAFETY INSTRUCTIONS

READ ALL INSTRUCTIONS BEFORE USE

Safety Messages

Your safety and the safety of others are very important.

We have provided many important safety messages in this manual and on your appliance. Always read and follow all safety messages.



This is the safety alert symbol.

This symbol alerts you to potential hazards that can kill or injure you and others. All safety messages will follow the safety alert symbol and either the word WARNING or CAUTION.



WARNING

You may be killed or seriously injured if you do not follow instructions.



CAUTION

You may be injured or cause damage to the product if you do not follow instructions.

All safety messages will tell you what the potential hazard is, tell you how to reduce the chance of injury, and tell you what may happen if the instructions are not followed.

WARNING STATEMENTS

WARNING

- To reduce the risk of explosion, fire, death, electric shock, scalding or injury to persons when using this product, follow basic precautions, including the following:

Installation

- Before use, the appliance must be properly installed as described in this manual.
- Connect to a properly rated, protected, and sized power circuit to avoid electrical overload.
- To reduce the risk of severe injury or death, follow all installation instructions.
- The appliance must be installed and electrically grounded by qualified service personnel in accordance with local codes.
- Disconnect the power cord, house fuse or circuit breaker before installing or servicing the appliance.
- When moving or installing the appliance in a different location, call qualified service personnel for installation and service.
- Keep packing materials out of the reach of children. Packaging material can be dangerous for children. There is a risk of suffocation.
- Moving or installation of the appliance requires two or more people.
- This appliance is not designed for maritime use or for mobile installations such as in RVs, trailers, or aircraft.
- This appliance must be positioned near to an electrical power supply.
- Do not, under any circumstances, cut or remove the third (ground) prong from the power cord.
- When installing or moving the appliance, be careful not to pinch, crush, or damage the power cord.
- Do not install the appliance in humid spaces.

4 IMPORTANT SAFETY INSTRUCTIONS

- Destroy the carton, plastic bag, and other packing materials after the appliance is unpacked. Children might use them for play. Cartons covered with rugs, bedspreads, or plastic sheets can become airtight chambers.
- Adhere to all industry recommended safety procedures including the use of long-sleeved gloves and safety glasses.
- Place the appliance at least 18 inches above the floor for a garage installation.
- Do not install near another heat source such as a stove, oven or heater.
- The appliance must not be supplied through an external switching device, such as a timer, or connected to a circuit that is regularly switched on and off by a utility.
- Certain internal parts are intentionally not grounded and may present a risk of electric shock only during servicing. Service personnel – Do not contact the following parts while the appliance is energized: Motor, Control Board, Noise Filter.

Operation

- Never attempt to operate this appliance if it is damaged, malfunctioning, partially disassembled, or has missing or broken parts, including a damaged cord or plug.
- Repair or immediately replace all power cords that have become frayed or otherwise damaged. Do not use a cord that shows cracks or abrasion damage along its length or at either end.
- If you detect a strange sound, a chemical or burning smell, or smoke coming from the appliance, unplug it immediately, and contact an LG Electronics customer information center.
- Never unplug the appliance by pulling on the power cord. Always grip the plug firmly and pull straight out from the outlet.
- Do not use an extension cord or adapter with this appliance.
- Do not grasp the power cord or touch the appliance controls with wet hands.
- Do not modify or extend the power cord.
- If the appliance has been submerged, contact an LG Electronics customer information center for instructions before resuming use.
- Do not store or use gasoline or other flammable vapors and liquids in the vicinity of this or any other appliance.
- Keep the area underneath and around your appliances free of combustible materials (lint, paper, rags, etc.), gasoline, chemicals and other flammable vapors and liquids.
- This appliance is not intended for use by persons (including children) with reduced physical, sensory or mental capabilities, or lack of experience and knowledge, unless they have been given supervision or instruction concerning the use of the appliance by a person responsible for their safety.
- Use this appliance only for its intended purpose.
- Do not abuse, sit on, or stand on the door of the appliance.
- Do not allow children to play on, in or with the appliance. Close supervision of children is necessary when the appliance is used near children.
- Do not tamper with controls.
- Fix the drain hose securely in place.
- Do not put oily or greasy clothing, candles or flammable materials on top of the appliance.
- Do not use fabric softeners or products to eliminate static unless recommended by the manufacturer of the fabric softener or product.
- Do not reach into the appliance if the drum is moving.
- Do not dry articles that have been previously cleaned in, washed in, soaked in, soiled with or spotted with gasoline, dry cleaning solvents, vegetable oil, cooking oil or other flammable or explosive substances, as they give off vapors that could ignite or explode.
- Do not use heat to dry articles containing foam rubber or similarly textured rubber-like materials.

- Do not store plastic, paper, or clothing that may burn or melt on top of the dryer during operation.
- Always check the inside of the appliance for foreign objects before use.
- Do not place items exposed to cooking oils in your dryer. Items contaminated with cooking oils may contribute to a chemical reaction that could cause a load to catch fire. To reduce the risk of fire due to contaminated loads, the final part of a tumble dryer cycle occurs without heat (cool down period). Avoid stopping a tumble dryer before the end of the drying cycle unless all items are quickly removed and spread out so that the heat is dissipated.
- Do not let children or pets climb inside the dryer drum.
- Do not put living animals such as pets inside the appliance.
- Do not put any part of your body, such as your hands or feet, or metal objects under the appliance.
- Do not let your hand get pinched when opening or closing the dryer door.
- Do not use replacement parts that have not been recommended by the manufacturer (e.g. parts made at home using a 3D printer).

Maintenance

- Do not repair or replace any part of the appliance. All repairs and servicing must be performed by qualified service personnel unless specifically recommended in this Owner's Manual. Use only authorized factory parts
- Do not disassemble or repair the appliance by yourself.
- Remove any dust or foreign matter from the power plug pins.
- Disconnect this appliance from the power supply before cleaning and attempting any user maintenance. Turning the controls to the OFF position does not disconnect this appliance from the power supply.
- Remove the door before the appliance is removed from service or discarded to avoid the danger of children or small animals getting trapped inside.
- Unplug the appliance before cleaning to avoid the risk of electric shock.
- The interior of the appliance and exhaust duct should be cleaned periodically by qualified service personnel.
- Certain internal parts are intentionally not grounded and may present a risk of electric shock only during servicing. Service personnel – Do not contact the following parts while the appliance is energized: Motor, Control Board, Noise Filter.
- To avoid physical injury and burns, use care when cleaning the condenser and do not touch or clean the condenser with bare hands.

Grounding Instructions

- Improper connection of the equipment-grounding conductor can result in a risk of electric shock. Check with a qualified electrician or service personnel if you are in doubt whether the appliance is properly grounded. Do not modify the plug provided with the appliance; if it will not fit the outlet, have a proper outlet installed by a qualified electrician.
- The appliance must be grounded. In the event of a malfunction or breakdown, grounding will reduce the risk of electric shock by providing a path of least resistance for electric current. The appliance is equipped with a cord having an equipment-grounding conductor and a grounding plug. The plug must be plugged into an appropriate outlet that is installed and grounded in accordance with all local codes and ordinances.
- The appliance must be plugged into a properly grounded outlet. Electrical shock may result if the appliance is not properly grounded. Have the wall outlet and circuit checked by a qualified electrician to make sure the outlet is properly grounded. Failure to follow these instructions may create an electric shock hazard and/or a fire hazard.

CAUTION STATEMENTS

CAUTION

- To reduce the risk of minor or moderate injury to persons, malfunction, or damage to the product or property when using this product, follow basic precautions, including the following:
-

Installation

- Install the appliance on a firm and level floor.
- Store and install the appliance where it will not be exposed to temperatures below freezing or exposed to outdoor weather conditions.

Operation

- Clean the lint filter before or after each load.
- Do not use fabric softeners or products to eliminate static unless recommended by the manufacturer of the fabric softener or product.
- If the drain hose is frozen in winter, thaw it out before use.

SAVE THESE INSTRUCTIONS

PRODUCT OVERVIEW

Product Features

The images in this guide may be different from the actual components and accessories, which are subject to change by the manufacturer without prior notice for product improvement purposes.

Front View

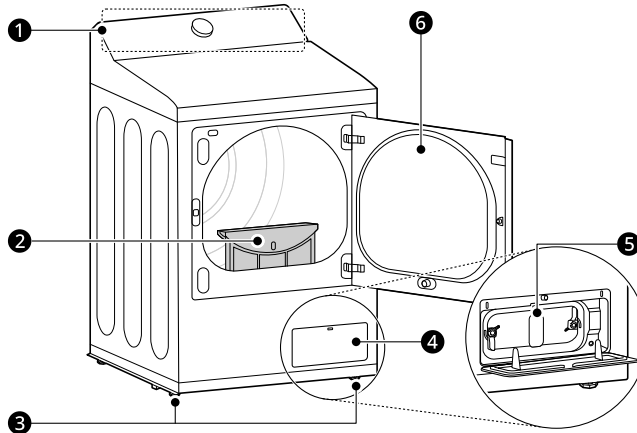

- ❶ Control Panel
- ❷ Lint filters
- ❸ Leveling feet
- ❹ Access panel
- ❺ Condenser cover
- ❻ Door

Rear View

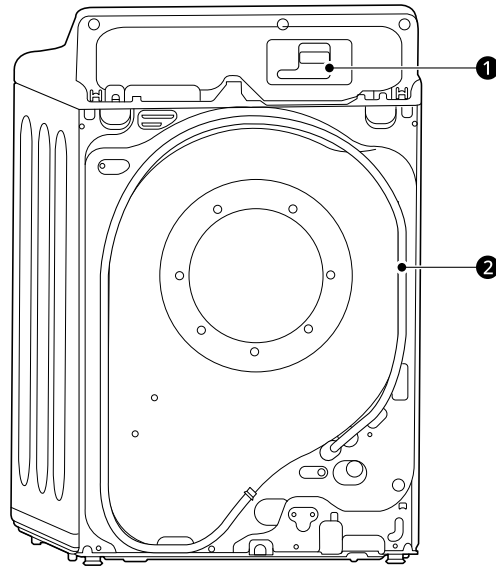

- ❶ Terminal Block Access Panel
- ❷ Drain Hose

Product Specifications

Model		DLHC8402*
Electrical Requirements		Please refer to the rating label for detailed information.
Dimensions (Width X Depth X Height)		27" X 30 1/4" X 42 3/4" (70.0 cm X 77.0 cm X 109.0 cm)
Maximum Depth with Door Open		51 1/2" (131.0 cm)
Net Weight		155 lb (71 kg)
Capacity	Normal Cycle	7.3 cu.ft. (22.5 lb / 10.2 kg)

Accessories

Included Accessories

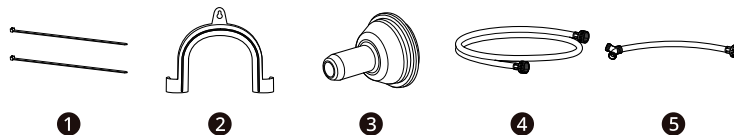

- ❶ CableTies (2 EA)
- ❷ Elbow Bracket for Securing Drain Hose (1EA)
- ❸ Drain Hose Holder (1EA)

- ④ Inlet Hose (1EA)
- ⑤ Y-Connector Inlet Hose (1EA)

Required Accessories for the Electric Dryer (sold separately)



- ① 4-wire power cord kit
- ② 3-wire power cord kit

Optional Accessories (sold separately)



1

1 Drying Rack

NOTE

- For your safety and extended product life, use only authorized components. The manufacturer is not responsible for product malfunction or accidents caused by the use of unauthorized components or parts.
-

INSTALLATION

Before Installing

Installation Overview

Please read the following installation instructions first after purchasing this dryer or transporting it to another location.

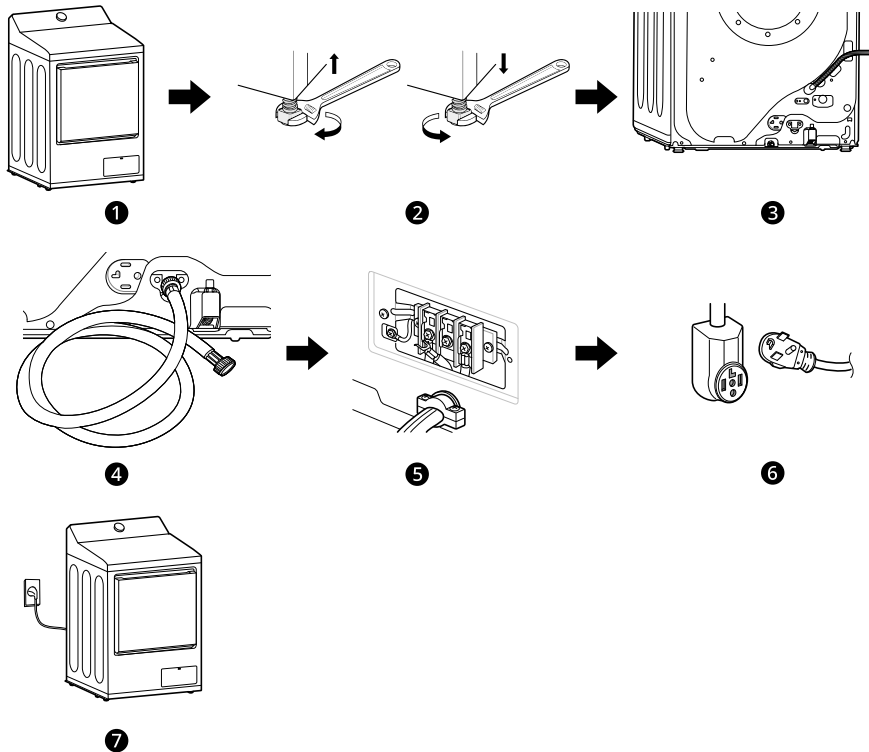

- ❶ Choose the proper location.
- ❷ Level the appliance.
- ❸ Connect the drain hose.
- ❹ Connect the inlet hose. (If using with a washing machine, connect the Y-connector hose as well.)
- ❺ Connect the heat pump electric dryer.
- ❻ Plug in the power cord.
- ❼ Final Installation Check

Choosing the Proper Location

WARNING

- Read all installation instructions completely before installing and operating the appliance. It is important that you review this entire manual before installing and using the appliance. Detailed instructions concerning electrical connections and additional requirements are provided on the following pages.
-

Electricity

Use an individual, grounded electrical outlet located within 2 ft. (61 cm) of either side of the appliance.

WARNING

- Do not install or store the appliance in an area where it will be exposed to water and/or weather.
-

NOTE

- Check code requirements that limit, or do not permit, installation of the dryer in garages, mobile homes or sleeping quarters. If you have questions, contact your local building inspector.
-

Flooring

To avoid noise and vibration, the appliance must be installed and leveled on a solidly constructed floor with a maximum slope of 1 inch (2.5 cm). If required, adjust the leveling legs to compensate for the unevenness of the floor.

NOTE

- A sturdy floor is needed to support the total appliance weight when loaded. The combined weight of additional appliances should also be considered.
 - Clothes may not tumble properly, and automatic sensor cycles may not operate correctly if the appliance is not level.
 - For garage installation, you will need to place the appliance at least 18 inches (45.7 cm) above the floor. The standard pedestal height is 15 inches (38 cm). You will need 18 inches (45.7 cm) from the garage floor to the bottom of the appliance.
-

Ambient Temperature

Install the appliance in an area where the temperature is over 41 °F (5 °C).

If the temperature around the appliance is too low, the appliance might not shut off at the end of an automatic cycle. This can result in longer drying times.

Dimensions and Clearances

The following clearances are recommended for the appliance.

- Additional clearances should be considered for ease of installation and servicing.
- Additional clearances should be considered on all sides of the dryer to reduce noise transfer.

Installation Spacing for Recessed Area or Closet Installation

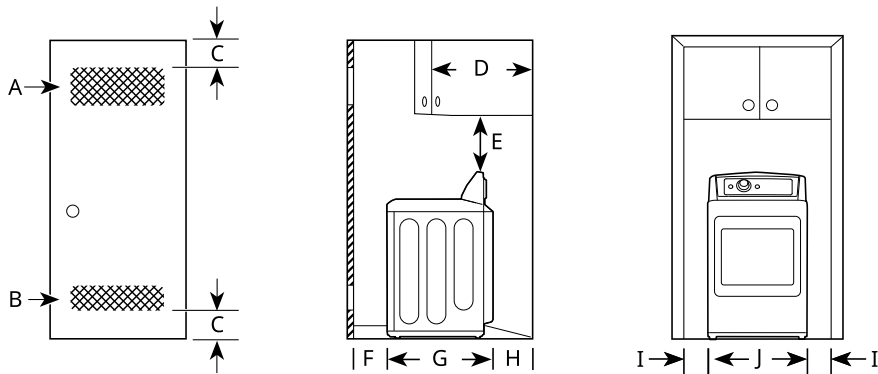

-	Description	Dimension/Clearance
A	Upper Ventilation Opening	≥ 48 sq. in. (310 cm ²)
B	Lower Ventilation Opening	≥ 24 sq. in. (155 cm ²)
C	Distance to Ventilation Opening	≥ 3" (76 mm)
D	Overhead Cabinet Depth	≤ 14" (356 mm)
E	Distance to the Overhead Cabinet/Shelf	≥ 18" (457 mm)
F	Front Clearance	1" (25 mm)
G	Depth	30 1/4" (770 mm)
H	Back Clearance	≥ 5" (127 mm)
I	Side Clearance	≥ 1" (25 mm)
J	Width	27" (700 mm)

Closet Ventilation Requirements

Closets with doors must have both an upper and lower vent to prevent heat and moisture buildup in the closet. One upper vent opening with a minimum opening of 48 sq. in. (310 cm²) must be installed no lower than 6 feet above the floor. One lower vent opening with a minimum opening of 24 sq. in. (155 cm²) must be installed no more than one foot above the floor. Install vent grilles in the door or cut down the door at the top and bottom to form openings. Louvered doors with equivalent ventilation openings are also acceptable.

NOTE

- There should be at least a little space around the dryer (or any other appliance) to eliminate the transfer of vibration from one appliance to another. If there is enough vibration, it could cause appliances to make noise or come into contact, causing paint damage and further increasing noise.
- No other fuel-burning appliance can be installed in the same closet as a dryer.

Installation Spacing for Cabinet

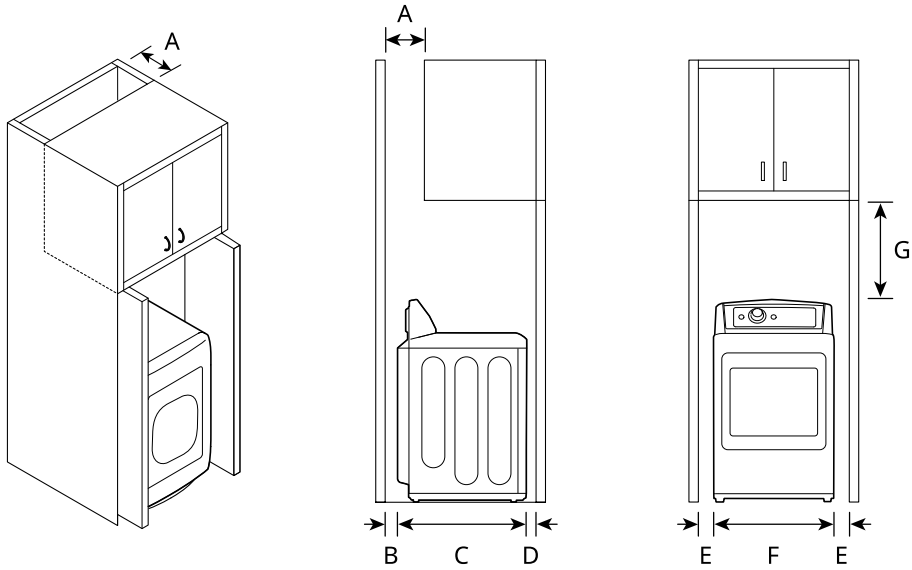

For cabinet installation with a door, minimum ventilation openings in the top of the cabinet are required.

-	Description	Dimension/Clearance
A	Depth of Ventilation Opening	≥ 7" (178 mm)
B	Back Clearance	≥ 5" (127 mm)
C	Depth	30 1/4" (770 mm)
D	Front Clearance	≥ 1" (25mm)
E	Side Clearance	≥ 1" (25 mm)
F	Width	27" (700 mm)
G	Clearance to Top of Cabinet	≥ 9" (229 mm)

Leveling the Appliance

⚠ WARNING

- Use long-sleeved gloves and safety glasses.
- The appliance is heavy. Two or more people are required when installing the appliance.

Checking the Level

Position the appliance in the final location and place a level across the top of the appliance.

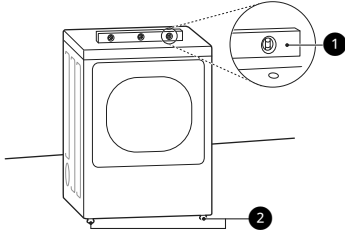

- ① Level
- ② Leveling Feet

NOTE

- All four leveling feet must rest solidly on the floor. Gently push on the top corners of the appliance to make sure that the appliance does not rock from corner to corner.
- Adjust the leveling feet only as far as necessary to level the appliance. Extending the leveling feet more than necessary may cause the appliance to vibrate.
- To ensure that the appliance provides optimal drying performance, it must be level. To minimize vibration, noise, and unwanted movement, the floor must be a perfectly level, solid surface.

Adjusting the Leveling Feet

Use an adjustable wrench to turn the leveling feet. Unscrew the legs to raise the appliance or screw in the legs to lower it. Raise or lower with the leveling feet until the appliance is level from side to side and front to back. Make sure that all four leveling feet are in firm contact with the floor.

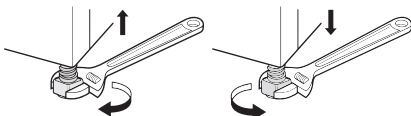

NOTE

- If you are installing the appliance on the optional pedestal, you must use the leveling feet on the pedestal to level the appliance. The appliance leveling feet should be fully retracted.

Reversing the Door

⚠ WARNING

- Support the door with a stool or box that fits under the door, or have an assistant support the weight of the door.
- Avoid dropping the door.
- Unplug the appliance or turn off power at the main circuit breaker before beginning door reversal.

Tools Required

- Phillips screwdriver
- Large flat blade screwdriver (recommended for hinge screws if they are tight or your Phillips screwdriver is worn)
- Small flat blade screwdriver (for lifting out parts)

Door Reversal Instructions

The instructions here are for changing the door swing from a right to a left side hinge. If the door has been reversed, and it is necessary to change it back, use care when following these instructions. Some of the illustrations and the left/right references will be reversed, and you will need to read the instructions carefully.

- 1 Open the door from the side so that the hinge screws are accessible.

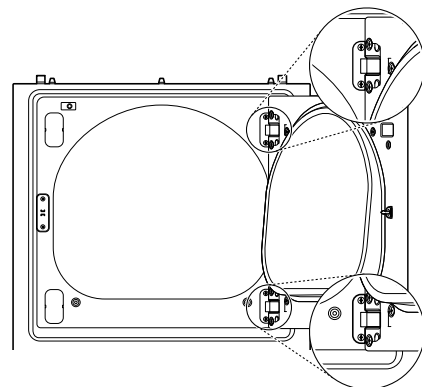

- 2** While supporting the door, remove the 2 screws **1** on the door hinge, two from each hinge. Set the door aside face down on a protected surface to prevent damage to the door or the work surface.

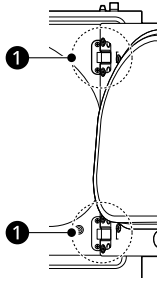

⚠ WARNING

- Be sure to support the weight of the door before removing the hinge screws.
- The edges of the door cover may be sharp. Take care when handling, or wear gloves to avoid injury.

- 3** Reverse the components on the cabinet.

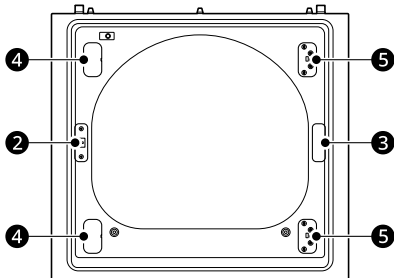

- 1) Use a Phillips screwdriver to remove the two screws and the latch mechanism **2** on the front panel of the cabinet.
- 2) Remove the latch hole cover **3** by gently prying it up with a flat blade screwdriver, being careful not to scratch the paint. Install the latch hole cover on the opposite side, where the latch mechanism was removed. Install the latch mechanism in the position from which you removed the latch hole cover, using the two screws removed in the previous step.
- 3) Remove the two hinge covers **4** by gently prying them up with a flat blade screwdriver, being careful not to scratch the paint. Rotate the two hinge covers 180 degrees and install them on the opposite

side **5**, where the two hinges were attached.

- 4** With the door on a protected surface, remove all screws on each side of the door and lift off the inner door frame **6** using a flat blade screwdriver. Remove the latch hook **7** and blank **8** and install them on the opposite side.

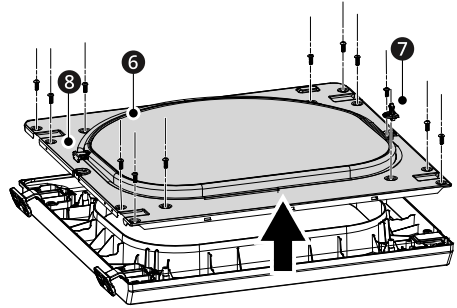

- 5** Remove the two plastic cover caps **10**. Reinstall the hinges **9** and cover caps **10** on the opposite sides from which they were removed.

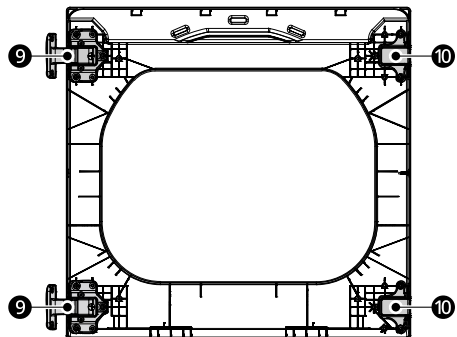

- 6** With the hinges and cover caps in the new locations, remount the inner door frame onto the outer door frame with the screws removed in step 4.

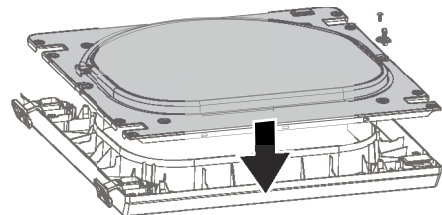

- 7** Reinstall the door with the screws removed in step 2.

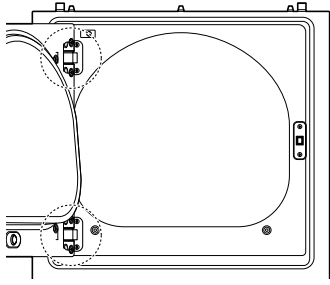

Connecting Electric Dryers

⚠ WARNING

- To reduce the risk of fire or explosion, electric shock, property damage, injury to persons, or death when using this appliance, fulfill the following requirements.

Electrical Requirements for Electric Models

⚠ WARNING

- The wiring and grounding must conform to the latest edition of the National Electrical Code, ANSI/NFPA 70 and all applicable local regulations. Please contact a qualified electrician to check your home's wiring and fuses to ensure that your home has adequate electrical power to operate the appliance.
- This appliance must be connected to a grounded metal, permanent wiring system, or an equipment-grounding conductor must be run with the circuit conductors and connected to the equipment-grounding terminal or lead on the appliance.
- The appliance has its own terminal block that must be connected to a separate 240 VAC, 60-Hertz, single-phase circuit, fused at 15 amperes. (The circuit must be fused on both sides of the line.) ELECTRICAL SERVICE FOR THE APPLIANCE SHOULD BE OF THE MAXIMUM RATE VOLTAGE LISTED ON THE NAMEPLATE. DO NOT CONNECT THE APPLIANCE TO 110-, 115-, OR 120-VOLT CIRCUIT.
- If the branch circuit to appliance is 15 ft. (4.5 m) or less in length, use UL (Underwriters Laboratories) listed No.-10 AWG wire (copper wire only), or as required by local codes. If over 15 ft. (4.5 m), use UL-listed No.-8 AWG wire (copper wire only), or as required by local codes. Allow sufficient slack in wiring so the appliance

can be moved from its normal location when necessary.

- The power cord (pigtail) connection between the wall receptacle and the appliance terminal block IS NOT supplied with the appliance. Type of pigtail and gauge of wire must conform to local codes and with instructions on the following pages.
- Do not modify the plug and internal wire provided with the appliance.
- The appliance should be connected to a 4-hole outlet.
- If the plug does not fit the outlet, a proper outlet will need to be installed by a qualified electrician.
- Connect the power cord to the terminal block. Each colored wire should be connected to the same color screw. Wire color indicated in manual is connected to the same color screw in the block.
- Grounding through the neutral conductor is prohibited for: (1) new branch-circuit installations and (2) areas where local codes prohibit grounding through the neutral conductor.
- This appliance is supplied with the neutral wire grounded. This white ground wire MUST BE MOVED to the neutral terminal when a 4-wire cord is to be used, or where grounding through the neutral conductor is prohibited.

Four-Wire Power Cord

- A UL-listed strain relief is required.



- Use a 30-amp, 240-volt, 4-wire, UL-listed power cord with #10 AWG-minimum copper conductor and closed loop or forked terminals with upturned ends.

- Remove the terminal block access cover on the upper back of the appliance.
- Install UL-listed strain relief into the power cord through-hole.

18 INSTALLATION

- 3 Thread a 30-amp, 240-volt, 4-wire, UL-listed power cord with #10 AWG-minimum copper conductor through the strain relief.

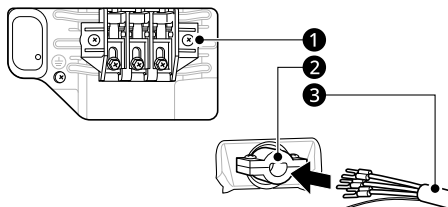

- 1 Terminal Block
- 2 UL-Listed Strain Relief
- 3 UL-Listed 4-Wire Power Cord

- 4 Transfer the appliance's ground wire from behind the green ground screw to the center screw of the terminal block.

- 5 Attach the two hot leads (black and red) of the power cord to the outer terminal block screws.

- 6 Attach the neutral (white) wire to the center screw of the terminal block.

- 7 Attach the power cord ground wire to the green ground screw.

- 8 Tighten all screws securely.

- 9 Reinstall the terminal block access cover.

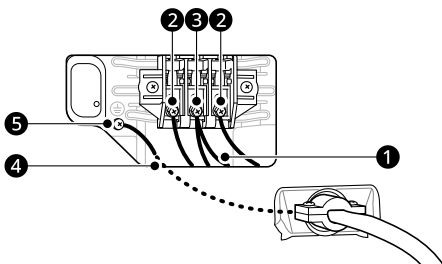

- 1 White Wire moved from Ground Screw
- 2 Hot Leads of Power Cord (Black and Red)
- 3 Neutral Wire (White)

- 4 Power Cord Ground Wire

- 5 Ground Screw

Four-Wire Direct Wire

- A UL-listed strain relief is required.

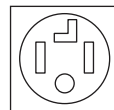

- Use UL-listed 4-wire #10 AWG minimum copper conductor cable. Allow at least 5 ft. (1.5 m) of wire to allow for removal and reinstallation of the dryer.

- 1 Remove 5 inches (12.7 cm) of the outer covering from the wire and remove 5 inches of insulation from the ground wire. Cut off approximately 1.5 inches (3.8 cm) from the other three wires and strip 1 inch (2.5 cm) insulation from each wire. Bend the ends of the three shorter wires into a hook shape.

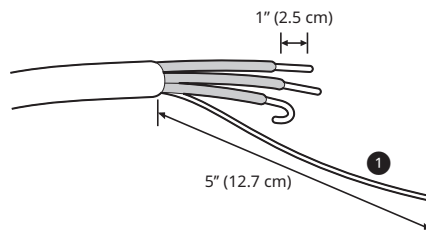

- 1 Ground Wire

- 2 Remove the terminal block access cover on the upper back of the appliance.

- 3 Install UL-listed strain relief into the power cord through-hole.

- 4 Thread the 4-wire #10 AWG minimum copper power cable prepared in step 1 through the strain relief.

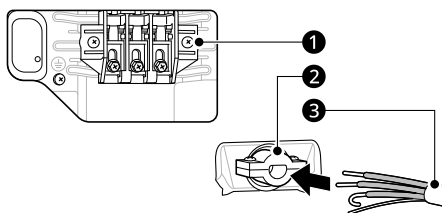

- ❶ Terminal Block
- ❷ UL-Listed Strain Relief
- ❸ UL-Listed 4-Wire Power Cord

- 5 Transfer the appliance's ground wire from behind the green ground screw to the center of the terminal block.
- 6 Attach the two hot leads (black and red) of the power cord to the outer terminal block screws.
- 7 Attach the neutral (white) wire to the center screw of the terminal block.
- 8 Attach the power cord ground wire to the green ground screw.
- 9 Tighten all screws securely.
- 10 Reinstall the terminal block access cover.

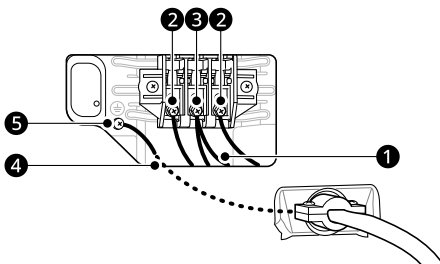

- ❶ White Wire moved from Ground Screw
- ❷ Hot Leads of Power Cord (Black and Red)
- ❸ Neutral Wire (White)
- ❹ Power Cord Ground Wire
- ❺ Ground Screw

Three-Wire Power Cord

- A 3-wire connection is NOT permitted on new construction after January 1, 1996.
- A UL-listed strain relief is required.



- Use a 30-amp, 240-volt, 3-wire, UL-listed power cord with #10 AWG-minimum copper conductor and closed loop or forked terminals with upturned ends.

- 1 Remove the terminal block access cover on the upper back of the appliance.
- 2 Install the UL-listed strain relief into the power cord through-hole.
- 3 Thread a 30-amp, 240 volt, 3-wire, UL-listed power cord with #10 AWG-minimum copper conductor through the strain relief.

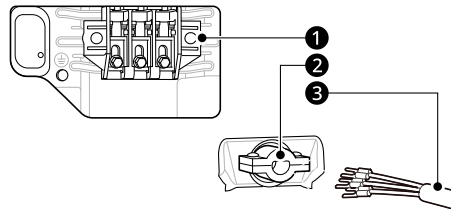

- ❶ Terminal Block
- ❷ UL-Listed Strain Relief
- ❸ UL-Listed 3-Wire Power Cord

- 4 Attach the two hot leads (black and red) of the power cord to the outer terminal block screws.
- 5 Attach the neutral (white) wire to the center terminal block screw.
- 6 Connect the external ground (if required by local codes) to the green ground screw.
- 7 Tighten all screws securely.
- 8 Reinstall the terminal block access cover.

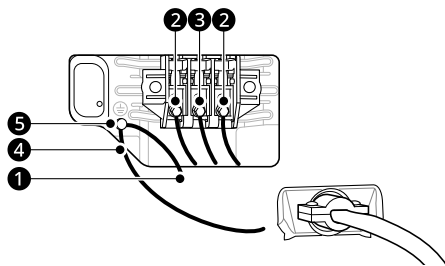

- ❶ White Wire from Dryer Harness
- ❷ Hot Leads of Power Cord (Black and Red)
- ❸ Neutral Wire (White)
- ❹ External Ground Wire (if required by local codes)
- ❺ Ground Screw

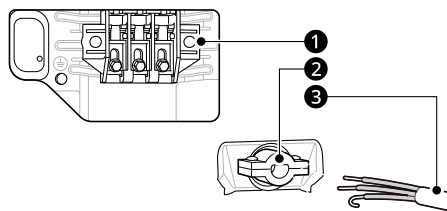

- ❶ Terminal block
- ❷ UL-listed strain relief
- ❸ UL-listed 3-wire power cord

5 Attach the two hot leads (black and red) of the power cord to the outer terminal block screws.

6 Attach the neutral (white) wire to the center terminal block screw.

7 Connect the external ground (if required by local codes) to the green ground screw.

8 Tighten all screws securely.

9 Reinstall the terminal block access cover.

Three-Wire Direct Wire

• A 3-wire connection is NOT permitted on new construction after January 1, 1996.

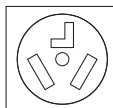

- A UL-listed strain relief is required.
- Use UL-listed 3-wire, #10 AWG minimum copper conductor cable. Allow at least 5 ft. (1.5 m) length to allow for removal and installation of dryer.

1 Remove 3.5 inches (8.9 cm) of the outer covering from the wire. Strip 1 inch (2.5 cm) insulation from each wire. Bend the ends of the three wires into a hook shape.

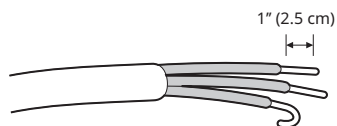

2 Remove the terminal block access cover on the upper back of the appliance.

3 Install UL-listed strain relief into the power cord through-hole.

4 Thread the 3-wire, #10 AWG minimum copper conductor power cable prepared in step 1 through the strain relief.

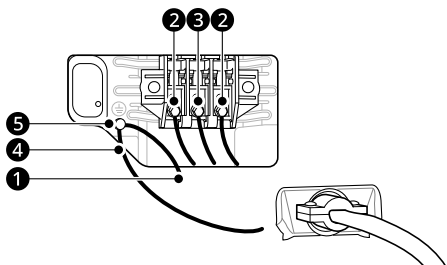

- ❶ Hot lead (black and red)
- ❷ Neutral wire (white)
- ❸ External ground wire (if required by local codes)
- ❹ Wire from the appliance harness
- ❺ Ground screw (green)

Connecting the Water Inlet Hose

To use direct water clean, the dryer must be connected to the cold water tap using a new water supply hose. Do not use old hoses.

⚠ WARNING

- Do not overtighten the hoses or cross-thread the hose fittings. Overtightening or cross-threading can damage the valves or couplings, resulting in leaking and property damage.
- Do not reuse old hoses. Use only new hoses when installing the appliance. Old hoses could leak or burst causing flooding and property damage. Contact an LG Customer Information Center for assistance in buying hoses.

⚠ CAUTION

- Periodically check the hoses for cracks, leaks, and wear, and replace the hoses every five years.
- Do not stretch the water hoses intentionally, and make sure that they are not pinched, crushed or kinked by other objects.
- Water supply pressure must be between 20 psi and 120 psi (138 - 827 kPa). If the water supply pressure is more than 120 psi, a pressure reducing valve must be installed.
- Do not store or install the appliance in a location subject to freezing temperatures. Damage to the water inlet hoses and internal mechanisms of the appliance can result. If the appliance was exposed to freezing temperatures prior to installation, allow it to stand at room temperature for several hours before use and check for leaks prior to operation.
- Do not use flood-preventing hoses with auto shut off devices. The devices can be tripped during fill and prevent the appliance from filling properly.
- If your water supply contains a lot of debris, a whole home water filter may help to remove the debris from the water before it reaches the dryer inlets.

How to Connect the Water Inlet Hoses

- 1 Check the fittings and seals. Inspect the threaded fitting on each hose and make sure there is a rubber seal ❶ in place in both ends of each hose to prevent leaking.

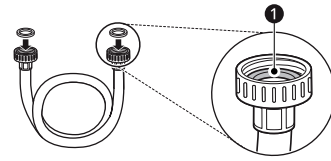

- 2 Check the type of installation and connect the hose to the faucet. Connect all water supply hoses tightly by hand and then tighten another 2/3 turn with pliers.

- Type 1 : WITHOUT WASHER (The dryer does not share the faucet with the washing machine.)

- 1) Connect the dryer inlet hose ❷ to the cold water faucet.

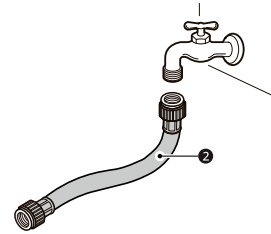

- Type 2 : WITH WASHER (The dryer shares the faucet with the washing machine.)

- 1) Shut off the cold water tap and remove the washer inlet hose.
- 2) Connect the Y-connector inlet hose ❸ to the cold water faucet.
- 3) Connect the dryer inlet hose ❷ to one side of the Y-Connector inlet hose ❸.
- 4) Connect the washer hose to the washer and the other side of the Y-Connector inlet hose ❸.

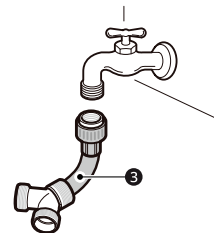

NOTE

- Before connecting the water line to the dryer, flush several gallons of water into a drain or bucket. This will help prevent foreign particles such as sand and scale from clogging the dryer inlet valve.

22 INSTALLATION

- 3 Connect the dryer inlet hose ② to the dryer inlet valve tightly by hand and then tighten another 2/3 turn with pliers.

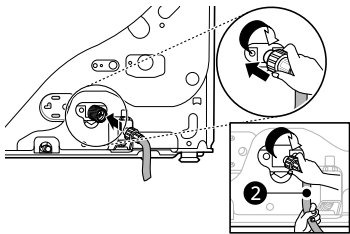

- 4 Turn on the cold water faucet.

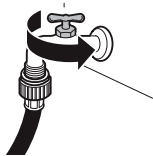

- 5 Check all hoses and Y-connectors (if used) for leaks.

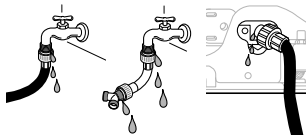

NOTE

- If any leaks are found, shut off the water faucet, remove the hose and check the condition of the rubber seal.
- In areas with hard water, mineral scale can form on internal components of the dryer. Use of a water softener is recommended in areas with hard water. Excessive scale buildup may lead to the need for replacement or repair of certain parts.

Connecting the Drain Hose

The end of the drain hose must be at least **30cm (12in.)** and no more than **240cm (94in.)** from the bottom of the dryer.

WARNING

- The drain hose should always be properly secured. Failure to properly secure the drain

hose can result in flooding and property damage.

NOTE

- The drain must be installed in accordance with any applicable local codes and regulations.
- Make sure that the drain hose is not stretched, pinched, crushed, or kinked.

Using a Standpipe to Drain

- 1 Clip the end of the hose into the elbow bracket. Connect the drain hose holder to the end of the hose so that the hose does not come out.
 - Connect the elbow bracket ① within **4 inches (10 cm)** of the end of the drain hose. If the drain hose is extended more than **4 inches (10 cm)** beyond the end of the elbow bracket, mold or microorganisms could spread to the inside of the dryer.

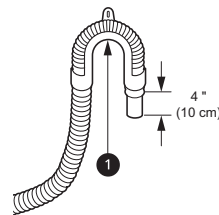

- When using the elbow bracket, insert the drain hose holder ② to prevent the hose from coming out.

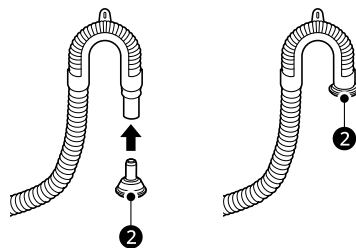

- 2 Insert the end of the drain hose into the standpipe.

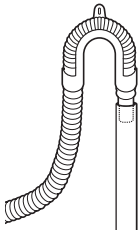

- 3** Use the provided tie strap **3** to secure the drain hose in place.

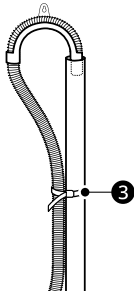

NOTE

- If the drain hose and standpipe are airtight, backflow may occur. Ensure it is not airtight.

Using the Laundry Tub to Drain

- 1** Clip the end of the hose into the elbow bracket. Connect the drain hose holder to the end of the hose so that the hose does not come out.
- Connect the elbow bracket **1** within **4 inches (10 cm)** of the end of the drain hose. If the drain hose is extended more than **4 inches (10 cm)** beyond the end of the elbow bracket, mold or microorganisms could spread to the inside of the dryer.

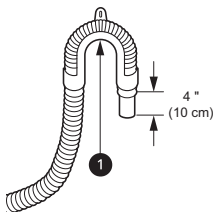

- 2** Hang the end of the drain hose over the side of the laundry tub.

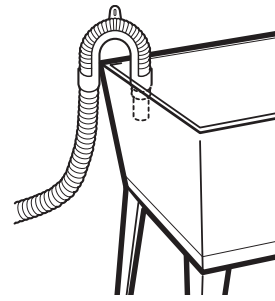

- 3** Use the provided tie strap to secure the drain hose in place.

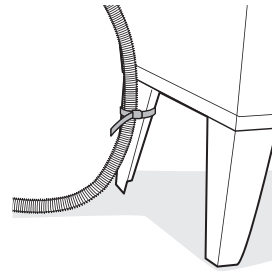

Final Installation Check

Once you have completed the installation of the dryer and it is in its final location, confirm proper operation with the following tests.

Checking Levelness

Once the dryer is in its final location, recheck the dryer to be sure it is level. Make sure it is level front to back and side to side, and that all four leveling feet are in firm contact with the floor.

OPERATION

Before Use

WARNING

- To reduce the risk of fire, electric shock, or injury to persons, read the **IMPORTANT SAFETY INSTRUCTIONS** before operating this appliance.

Operation Overview

NOTE

- When first installed, load a damp cloth or old towel and run a cycle to burn off any residual manufacturing oil. You may observe slight smoke or a burning smell, but these will disappear after the first use.

1 Clean the Lint Filter

- If the lint filter has not already been cleaned, lift out the filter and remove the lint from the last load. This will help ensure the fastest and most efficient drying performance. Make sure to reinstall the filter, pressing down until it clicks firmly into place.

2 Load the Dryer

- Make sure that clothing is pushed entirely into the drum and away from the door seal area. Clothing that gets stuck between the door and seal may be damaged or damage the seal.
- If the load is extra large, you may need to divide it into smaller loads for proper performance and fabric care.
- All strings and attached belts of clothes should be well tied and secured before being put into the drum.

3 Turn on the Dryer

- Press the **Power** button to turn on the dryer. The display will turn on and a chime will sound.

4 Select a Cycle

- Turn the cycle selector knob until the desired cycle is selected. The preset

temperature, dry level, and option settings for that cycle will be shown.

5 Adjust Settings

Default settings for the selected cycle can now be changed, if desired, using the cycle modifier and option buttons.

- Not all modifiers and options are available on all cycles.

6 Begin Cycle

- Press the **Start/Pause** button to begin the cycle. The cycle can be paused at any time either by opening the door or by pressing the **Start/Pause** button.
- If the **Start/Pause** button is not pressed within a certain time, the dryer shuts off and all settings are lost.

7 End of Cycle

- When the cycle is finished, the chime will sound. Immediately remove your clothing from the dryer to reduce wrinkling. If  (**Wrinkle Care**) is selected, the dryer will tumble briefly every few minutes to help prevent wrinkles from setting in the clothes.

Check the Lint Filter Before Every Load

Always make sure the lint filter **1** is clean before starting a new load; a clogged lint filter will increase drying time. To clean, pull the lint filter straight up and roll any lint off the filter with your

fingers. Push the lint filter firmly back into place. See **Regular Cleaning** for more information.

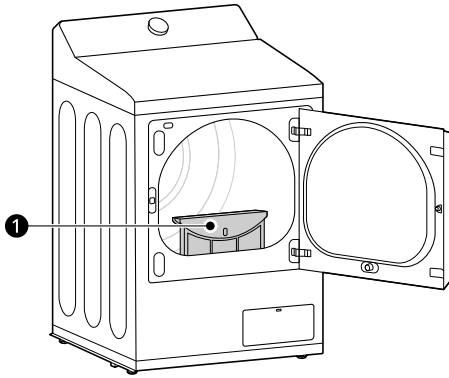

Always ensure that the lint filter is properly installed before running the dryer. Running the dryer with a loose or missing lint filter will damage the dryer and articles in the dryer.

Loading the Dryer

NOTE

- For the best drying performance and most efficient energy usage, do not overload the appliance.

General Tips

- Combine large and small items in the same load.
- Use mesh laundry bags to separate clothes with zippers, hooks, straps, and drawstrings to prevent them from catching on or tangling with other clothes or damaging the lint filter.

NOTE

- Damp clothes will expand as they dry. Do not overload the dryer; clothes require room to tumble and dry properly.

Grouping Similar Items

For the best drying results, and to reduce the possibility of damage to clothing, sort clothes into loads that can be dried with the same drying cycle.

Different fabrics have different care requirements, and some fabrics will dry more quickly than others.

Woolen Items

- Always follow fabric care labels before drying woolen items in a dryer. After the cycle, the items may still be damp. Do not repeat the cycle. Pull the items to their original shape if needed and lay them flat to finish drying.

Woven and Loopknit Materials

- Some woven and loopknit materials may shrink, depending on quality.

Permanent Press and Synthetics

- Do not overload your dryer. Take out permanent press items as soon as the dryer stops to reduce wrinkles.

Baby Clothes and Nightgowns

- Always check the manufacturer's instructions.

Rubber and Plastics

- Do not dry any items made from or containing rubber or plastics such as:
 - Aprons, bibs and chair covers
 - Curtains and tablecloths
 - Bath mats

Fiberglass

- Do not dry fiberglass articles in your dryer. Glass particles left in the dryer could be picked up by your clothes the next time you use the dryer and irritate your skin.





Fabric Care Labels





- Sort and dry laundry according to care labels, size, and fabric type. Do not overload the dryer. This will save energy and time and give the best drying performance.

Fabric Care Labels

Many articles of clothing include a fabric care label. Using the chart below, adjust the cycle and option selections to care for your clothing according to the manufacturer's recommendations.

Tumble Dry	
Label	Directions
□	Dry

Tumble Dry	
Label	Directions
	Normal
	Permanent Press / Wrinkle Resistant
	Gentle / Delicate
	Do not tumble dry
	Do not dry (used with do not wash)

Heat Setting	
Label	Directions
	High
	Medium
	Low
	No Heat / Air

Control Panel

Control Panel Features

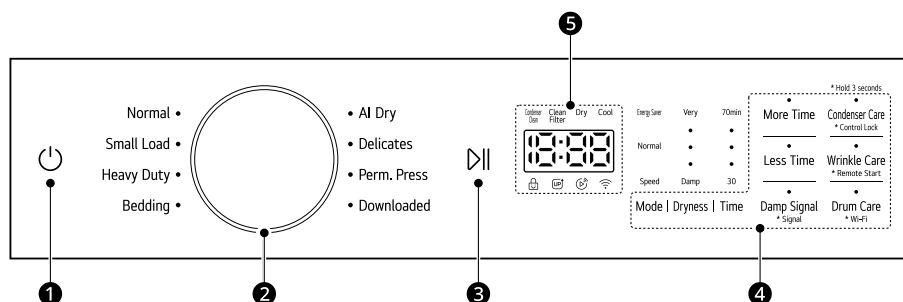

1 Power On/Off Button

- Press this button to turn the appliance on and press and hold it briefly to turn it off.
- Pressing this button during a cycle will cancel that cycle and any load settings will be lost.

2 Cycle Selector Knob

- Turn this knob to select the desired cycle or option.
- Once the desired cycle has been selected, the standard presets will appear in the display. These settings can be adjusted using the **Cycle Modifier buttons** at any time before starting the cycle.

3 Start/Pause Button

- Press this button to start the selected cycle.
- If the appliance is running, use this button to pause the cycle without losing the current settings.

NOTE

- If you do not press the **Start/Pause** button to resume a cycle within a certain time, the appliance turns off automatically and all cycle settings are lost.

4 Extra Options and Functions / Cycle Modifier Buttons

- Use these buttons to select the desired options for the selected cycle. Not all options are available for each cycle.

5 Time and Status Display

- The display shows the settings, estimated time remaining, options, and status message for the appliance. When the appliance is turned on, the default setting in the display will illuminate.

Time and Status Display

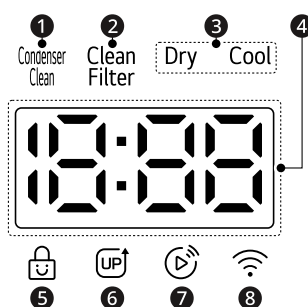

1 Condenser Clean Indicator

- This icon indicates the condenser auto cleaning status. The icon is displayed when water is being sprayed on the condenser.

② Clean Filter Reminder

- This indicator lights up at the beginning of the cycle to remind you to check the lint filter. It turns off when the **Start/Pause** button is pressed.

③ Cycle Status Indicators

- **Dry** indicator lights up when the appliance is in the drying stage.
- **Cool** indicator lights up when the appliance is in the cool down stage.

④ Estimated Time Remaining

- When a drying cycle is selected, the estimated drying time for the selected cycle is displayed. This time will change if you select extra options for the cycle.
- The cycle time on Sensor Dry cycles may fluctuate as the appliance recalculates drying time for optimal results.

⑤  lights up When the **Control Lock** feature is activated.

⑥  lights up when a new **ThinQ** Up Feature is created. you can update it using **ThinQ** Application.

⑦  lights up when the **Remote Start** feature is activated.

⑧  lights up when the appliance is connected to a home Wi-Fi network.

Dry Cycles

Turn the knob or press the button to select the desired cycle. When you select a dry cycle the default settings will light up in the display.

Cycle Guide

The appliance automatically sets the dry level and temperature at the recommended setting for each cycle. The estimated time remaining will be shown in the display.

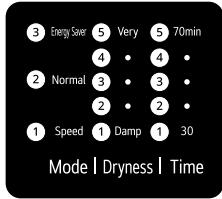
	<ul style="list-style-type: none"> • Mode indicator lights up and the selected setting is shown in the knob display: ① Speed, ② Normal, ③ Energy Saver • Dryness indicator lights up and the selected setting is shown in the knob display: ① Damp, ② Less, ③ Normal, ④ More, ⑤ Very • Time indicator lights up and the selected setting is shown in the knob display: ① 30 min, ② 40 min, ③ 50 min, ④ 60 min, ⑤ 70 min
---	--

Default Cycles

These cycles are in the initial cycle list.

Cycle	Normal	
Description	Use this cycle for drying all normal items such as cotton, linen, shirts, jeans or mixed loads, except delicate fabrics such as wool or silk.	
Dryness	Default: Normal	Available: All
Mode	Default: Normal	Available: All

Cycle	Small Load	
Description	Use this cycle for drying light or small items (less than 3 lb).	
Mode	Default: Speed	Available: Speed

Cycle	Heavy Duty	
Description	Use this cycle for drying heavy-duty clothes like jeans or garments that need extra drying.	
Mode	Default: Normal	Available: Normal

Cycle	Bedding	
Description	Use this cycle for drying blankets or bulky items such as pillows, blankets, comforters, sheets or pet bedding.	
Mode	Default: Normal	Available: Normal

Cycle	AI Dry	
Description	This cycle optimizes drying times and temperatures by detecting the laundry's characteristics.	
Mode	Default: Normal	Available: Normal

Cycle	Delicates	
Description	Use this cycle for drying dress shirts/blouses, nylons, lingerie, or sheer and lacy clothes which can easily be damaged.	
Dryness	Default: Normal	Available: All
Mode	Default: Speed	Available: Speed

Cycle	Perm. Press	
Description	Use this cycle to minimize wrinkles when drying tablecloths or wrinkle-free clothes.	
Dryness	Default: Normal	Available: Less, Normal
Mode	Default: Normal	Available: Normal

Manual Dry Cycles

Edit the list of dry cycles using the **Cycle List Edit** option to use these cycles.

Cycle	Time	
Description	Use this cycle to manually select the drying time, from 30 to 180 minutes.	
Mode	Default: Normal	Available: Normal
Time	Default: 30 minutes	Available: 30 - 180 minutes

Cycle	Condenser Care	
Description	Cleans built-up lint off of the condenser using water.	
Mode	Default: Speed	Available: Speed

Cycle	Drum Care	
Description	This cycle prevents unpleasant odors in the drum.	
Mode	Default: Speed	Available: Speed

Special Drying Cycles

These new or specialized drying cycles can be downloaded to your appliance with a smartphone.

Refer to the **LG ThinQ** smartphone application for a complete list of the cycles available for download.

Cycle	Wrinkle Prevention	
Description	This cycle prevents wrinkles caused by clothes sitting in the dryer by tumbling clothes without heat after the cycle is complete until the door is opened or the power is turned off.	
Dryness	Default : Normal	Available : All
Mode	Default : Normal	Available : All

Cycle	Rainy Days	
Description	Dries slightly wet clothes.	
Mode	Default : Speed	Available : Normal, Speed

Cycle	Easy Ironing	
Description	Leaves clothes slightly damp for easy ironing.	
Mode	Default : Speed	Available : Speed

Cycle	Outerwear Refresh	
Description	This cycle restores the durable water repellent treatment on your outerwear.	
Mode	Default : Speed	Available : Speed

Cycle	Activewear	
Description	Special or treated fabrics for sports or outerwear.	
Mode	Default : Energy Saver	Available : Energy Saver

Cycle	Down Jacket Refresh	
Description	This cycle is used to help restore the puffiness of down jackets.	
Mode	Default : Speed	Available : Speed

Cycle	Rack Dry	
Description	This cycle is used with items, such as wool sweaters, silk items, and lingerie, that should be dried flat. This cycle can also be used with items that should not be tumbled dry, such as gym shoes or stuffed animals. Install the drying rack (not included) in the dryer drum before using this cycle.	
Mode	Default : Energy Saver	Available : Energy Saver

Cycle	Bedding Refresh	
Description	Warms and fluffs up blankets.	
Mode	Default : Normal	Available : Normal

Cycle	Baby Wear	
Description	Use this cycle for drying a small amount of light clothing, such as baby clothes.	
Mode	Default : Normal	Available : Normal

Cycle	Air Dry	
Description	Use this cycle to dry all items (such as plastics or rubber) that can be tumble dried without using heat.	

Cycle	Power Dry	
Description	This cycle is a high-temperature dry cycle.	
Mode	Default : Speed	Available : Speed

Cycle	Shrinkage Relief	
Description	Reduces shrinkage by optimizing motion, dry level and temp.	
Dryness	Default : Less	Available : Damp, Less
Mode	Default : Normal	Available : Normal

Cycle	Silent Dry	
Description	Reduces sounds made during drying.	
Mode	Default : Normal	Available : Normal

Cycle	Towels	
Description	Use this cycle for drying towels.	
Mode	Default : Normal	Available : Normal

Selectable Drying Options

Cycle		Dry Mode				Damp Signal	Wrinkle Care
Cycle	Dry Level	Off	Energy Saver†	Normal	Speed		
Normal	Very		●	●	●	●	●
	More		●	●	●	●	●
	Normal		●	●	●	●	●
	Less		●	●	●		●
	Damp		●	●	●		●
Small Load	-				●		●
Heavy Duty	-			●			●
Bedding	-			●			●
AI Dry	-			●			●
Delicates	Very				●	●	●
	More				●	●	●
	Normal				●	●	●
	Less				●		●
	Damp				●		●

Cycle		Dry Mode				Damp Signal	Wrinkle Care
Cycle	Dry Level	Off	Energy Saver [†]	Normal	Speed		
Perm. Press	Normal			●		●	●
	Less			●			●
Time	-			●			●
Condenser Care	-				●		
Drum Care	-				●		
Wrinkle Prevention	Very		●	●	●		●
	More		●	●	●		●
	Normal		●	●	●		●
	Less		●	●	●		●
	Damp		●	●	●		●
Rainy Days	-			●	●		●
Easy Ironing	-				●		●
Outerwear Refresh	-				●		●
Activewear	-		●				●
Down Jacket Refresh	-				●		●
Rack Dry	-		●				
Baby Wear	-			●			●
Bedding Refresh	-			●			●
Air Dry	-	●					●
Power Dry	-				●		●
Shrinkage Relief	Damp			●			●
	Less			●			●
Silent Dry	-			●			●
Towels	-			●			●

† This option helps to reduce the energy use by drying clothes at a lower temperature than normal mode. When this option is set, the drying time will increase.

Cycle Modifiers

You can add or reduce the drying time using More Time / Less Time button. (30 - 180 Minutes)

About Modifier Buttons

Each cycle has default settings that are selected automatically. Customize these settings using the cycle modifier buttons. Repeatedly press the button for the desired modifier until the indicator light for the desired setting is lit. Not every option is available with every cycle. If a modifier is not available, the button chimes twice and the setting does not change.

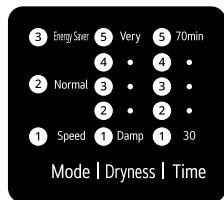

- **Mode** indicator lights up and the selected setting is shown in the knob display: ① **Speed**, ② **Normal**, ③ **Energy Saver**
- **Dryness** indicator lights up and the selected setting is shown in the knob display: ① **Damp**, ② **Less**, ③ **Normal**, ④ **More**, ⑤ **Very**
- **Time** indicator lights up and the selected setting is shown in the knob display: ① 30 min, ② 40 min, ③ 50 min, ④ 60 min, ⑤ 70 min

Mode

Use this option to help reduce energy consumption or save time when drying clothes.

- **Energy Saver:** Dry clothes with recommended settings at a lower temperature. When the option is set, the drying time will increase.
- **Normal:** Dry clothes with recommended settings.
- **Speed:** Dry clothes more quickly.

Dryness

Use this button to select the dryness level for the cycle. Press the **Dryness** button repeatedly to scroll through available settings.

- The appliance will automatically adjust the cycle time according to the selected dryness level. Selecting **More** or **Very** will increase the cycle time, while **Less** or **Damp** will decrease the cycle time.
- Use a **Less** or **Damp** setting for items that you wish to iron.

Time

Use this button to manually select the drying time, from 30 to 70 minutes.

Options and Extra Functions

Your dryer includes several additional cycle options to customize cycles to meet your individual needs.

Select the desired option after selecting the desired cycle and settings.

NOTE

- The LED for the option will light up when the option is selected.
- To protect your garments, not every option is available with every cycle.
- A chime will sound twice and the LED will not light up if the selected option is not allowed for the selected cycle.

Damp Signal

When this option is selected, the appliance signals when the load is approximately 80% dry. This allows you to remove faster-drying lightweight items or items that you would like to iron or hang while they are still slightly damp.

Press the **Damp Signal** button before you start a drying cycle.

Wrinkle Care

Selecting this option will tumble the load periodically for up to 2 hours after the selected cycle, or until the door is opened. This is helpful in preventing wrinkles when you are unable to remove items from the dryer immediately.

Press the **Wrinkle Care** button before you start a dry cycle.

NOTE

- When the option is turned on, only the **Power** button works after the dry cycle ends.
- To select the option after starting a cycle, pause the cycle, set the option, and press **Start/Pause**.
- Always turn off the appliance before unloading the clothes.
- When the option is turned on, a rectangle with a dashed line and End appears on the display until the feature is off.

Dry Time

Use this option to manually select the drying time, from 30 to 70 minutes, in 10-minute increments. Use this for small loads or to remove wrinkles.

NOTE

- Use the **More Time / Less Time** buttons to increase or decrease the drying time in 5-minute increments.

More Time / Less Time

Use these buttons to increase or decrease drying time in 5 minute increments when you use manual drying cycles such as **Rack Dry** and **Air Dry**.

Signal

The appliance plays a melody when the drying cycle is finished. The buttons make a sound each time they are pressed. Use this button to turn the melody and button tones on or off.

- To turn on/off, press and hold the **Damp Signal** button for 3 seconds.

Control Lock

Use this function to disable the controls. This function can prevent children from changing cycles or operating the dryer.

NOTE

- The function does not lock the door.
- Once this function is set, all buttons are locked except the **Power** button.
- When the controls are locked, \square and the remaining time are alternately shown on the display during the dry cycle.
- Turning off the power will not reset this function. You must deactivate this function before you can access any other options and functions.

Locking/Unlocking the Control Panel

- 1 Turn on the power.
- 2 Press and hold the **Condenser Care** button for 3 seconds to activate/deactivate this function.

36 OPERATION

- When the function is deactivated, a chime will sound and the remaining time for the current cycle will reappear on the display.

SMART FUNCTIONS

LG ThinQ Application

The **LG ThinQ** application allows you to communicate with the appliance using a smartphone.

LG ThinQ Application Features

- **Dryer Cycle**
 - Download new and specialized cycles that are not included in the standard cycles on the appliance. Appliances that have been successfully connected to the **LG ThinQ** application can download a variety of specialty cycles specific to the appliance.
- **Energy Monitoring**[†]
 - This feature keeps track of how the dryer's power consumption is affected by selected drying cycles and options.
- **Remote Control**
 - Control the appliance remotely or check to see how much time is left in the cycle from the **LG ThinQ** application.

NOTE

- Once the remote control feature is enabled, you can start a cycle from the **LG ThinQ** application. If the cycle is not started, the appliance will wait to start the cycle until the appliance is turned off remotely or the remote control feature is disabled.
- If the door is opened, the remote control feature is disabled.

• Push Messages

- When the cycle is complete or the appliance has problems, you will receive a push message.

• Smart DiagnosisTM

- This function provides useful information for diagnosing and solving issues with the appliance based on the pattern of use.

• Settings

- Allows you to set various options on the appliance and in the application.

[†] This feature is only available on some models.

NOTE

- In the following cases, you must update the network information for each appliance in the

LG ThinQ application under **Device Cards** → **Settings** → **Change Network**.

- wireless router is changed
- wireless router password is changed
- Internet service provider is changed
- This information is current at the time of publication. The application is subject to change for product improvement purposes without notice to users.

Installing LG ThinQ App and Connecting an LG Appliance

Models with QR Code

Scan the QR code attached to the product using the camera or a QR code reader app on your smartphone.

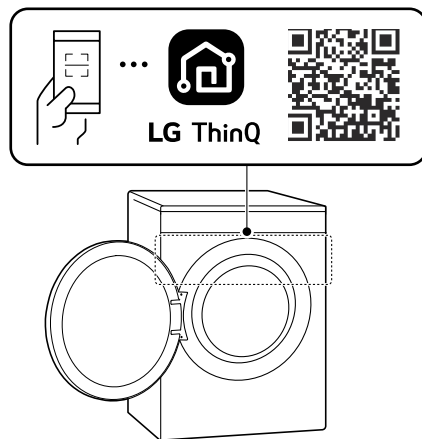

Models without QR Code

- 1** Search for and install the **LG ThinQ** app from the Google Play Store or Apple App Store on a smartphone.
- 2** Run the **LG ThinQ** app and sign in with your existing account or create an LG account to sign in.
- 3** Touch the add (+) button on the **LG ThinQ** app to connect your LG appliance. Follow the instructions in the app to complete the process.

NOTE

- You may be asked to provide a password to connect to the LG network (not your home network) during the Wi-Fi setup. The password is the last 4 characters of the network name, repeated twice, with no spaces. For example, if the network name appears as LG_XXXX_8b92, then you would enter 8b928b92 as your password. The password is case sensitive and the last 4 characters are unique to your appliance.
- To verify the Wi-Fi connection, check that the  icon on the control panel is lit.
- The appliance supports 2.4 GHz Wi-Fi networks only. To check your network frequency, contact your Internet service provider or refer to your wireless router manual.
- **LG ThinQ** is not responsible for any network connection problems or any faults, malfunctions, or errors caused by network connection.
- If the appliance is having trouble connecting to the Wi-Fi network, it may be too far from the router. Purchase a Wi-Fi repeater (range extender) to improve the Wi-Fi signal strength.
- The Wi-Fi connection may not connect or may be interrupted because of the home network environment.
- The network connection may not work properly depending on the Internet service provider.
- The surrounding wireless environment can make the wireless network service run slowly.
- If the appliance cannot be connected due to problems with the wireless signal transmission, unplug the appliance and wait about a minute before trying again.
- If the firewall on your wireless router is enabled, disable the firewall or add an exception to it.
- The wireless network name (SSID) should be a combination of English letters and numbers. (Do not use special characters.)
- Smartphone user interface (UI) may vary depending on the mobile operating system (OS) and the manufacturer.
- If the security protocol of the router is set to **WEP**, network setup may fail. Change the security protocol (**WPA2** is recommended) and connect the product again.

Using the Appliance Remotely**Remote Start**

Use a smartphone to control the appliance remotely. You can also monitor the cycle operation so you know how much time is left in the cycle.

Using Remote Start

- 1 Put the laundry into the drum and close the dryer door.
- 2 Press the **Power** button.
- 3 Press and hold the **Wrinkle Care** button for 3 seconds to enable the remote control function.
- 4 Start a cycle from the **LG ThinQ** application on your smartphone.

NOTE

- Once the function is enabled, you can only start a cycle from the **LG ThinQ** smartphone application. If the cycle is not started, the application will wait to start the cycle until it is turned off remotely from the application or this function is disabled.
- If the door has been opened, you cannot start a cycle remotely.

Disabling Remote Start Manually

When the function is activated, press and hold the **Wrinkle Care** button for 3 seconds.

Download Cycle

You can download new and specialized cycles that are not included in the standard cycles on the appliance.

Appliances that have been successfully connected to a Wi-Fi network can download a variety of specialty cycles specific to the appliance.

Once cycle download is completed in the appliance, the product keeps the downloaded cycle until a new cycle is downloaded.

NOTE

- Only one downloaded cycle can be stored on the appliance at a time.

Update your Product

You can update your product with new features through the **LG ThinQ** app.

- When new features are available, an update notification will appear on the control panel as below when you turn on the product.

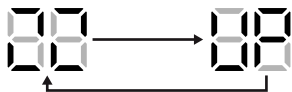

- After the update, the product function may change from what is indicated in the user manual.

- 1 Once you get an update notification, it will also send an update notification to your smartphone.
- 2 Tap the update notification on your smartphone to enter **Feature Updates** screen in the **LG ThinQ** app.
- 3 Once you enter **Feature Updates** screen, select the new features and tap the **update** button.
 - The progress of the update can be checked on the product's control panel.
 - Do not unplug the power plug of the product during the update, as it will interrupt the process.
- 4 After the update, to change the detailed settings of the updated features, refer to the guide within the **LG ThinQ** app.

This equipment has been tested and found to comply with the limits for a Class B digital device, pursuant to Part 15 of the FCC Rules. These limits are designed to provide reasonable protection against harmful interference in a residential installation. This equipment generates, uses, and can radiate radio frequency energy and, if not installed and used in accordance with the instructions, may cause harmful interference to radio communications. However, there is no guarantee that interference will not occur in a particular installation. If this equipment does cause harmful interference to radio or television reception, which can be determined by turning the equipment off and on, the user is encouraged to try to correct the interference by one or more of the following measures:

- Reorient or relocate the receiving antenna.
- Increase the separation between the equipment and the receiver.
- Connect the equipment into an outlet on a circuit different from that to which the receiver is connected.
- Consult the dealer or an experienced radio/TV technician for help.

This device complies with part 15 of the FCC Rules. Operation is subject to the following two conditions:

- (1) This device may not cause harmful interference and
- (2) This device must accept any interference received, including interference that may cause undesired operation.

Any changes or modifications in construction of this device which are not expressly approved by the party responsible for compliance could void the user's authority to operate the equipment.

Radio Equipment Specifications

Type	Operating Frequency Range	Output Power (Max.)
Wireless LAN	2400 MHz - 2472 MHz	< 1 W
Bluetooth [†]	2400 MHz - 2483.5 MHz	

[†] This feature is only available on some models.

FCC RF Radiation Exposure Statement

This equipment complies with FCC radiation exposure limits set forth for an uncontrolled environment. This transmitter must not be co-located or operating in conjunction with any other antenna or transmitter.

This equipment should be installed and operated with a minimum distance of 20 cm (7.8 inches) between the antenna and your body. Users must follow the specific operating instructions for satisfying RF exposure compliance.

FCC Notice

The following notice covers the transmitter module contained in this product.

Open Source Software Notice Information

To obtain the source code that is contained in this product, under GPL, LGPL, MPL, and other open source licenses that have the obligation to disclose source code, and to access all referred license terms, copyright notices and other relevant documents, please visit <https://opensource.lge.com>.

LG Electronics will also provide open source code to you on CD-ROM for a charge covering the cost of performing such distribution (such as the cost of media, shipping, and handling) upon email request to opensource@lge.com.

This offer is valid to anyone in receipt of this information for a period of three years after our last shipment of this product.

Smart Diagnosis™ Function

Use this feature to help you diagnose and solve problems with your appliance.

NOTE

- For reasons not attributable to LGE's negligence, the service may not operate due to external factors such as, but not limited to, Wi-Fi unavailability, Wi-Fi disconnection, local app store policy, or app unavailability.
- The feature may be subject to change without prior notice and may have a different form depending on where you are located.

Using LG ThinQ to Diagnose Issues

If you experience a problem with your Wi-Fi equipped appliance, it can transmit troubleshooting data to a smartphone using the **LG ThinQ** application.

- Launch the **LG ThinQ** application and select the **Smart Diagnosis** feature in the menu. Follow the instructions provided in the **LG ThinQ** application.

Using Audible Diagnosis to Diagnose Issues

Follow the instructions below to use the audible diagnosis method.

- Launch the **LG ThinQ** application and select the **Smart Diagnosis** feature in the menu. Follow the instructions for audible diagnosis provided in the **LG ThinQ** application.

- 1 Press the **Power** button to turn on the appliance.
 - Do not press any other buttons.
- 2 Hold the mouthpiece of your phone in front of the **Power** button.

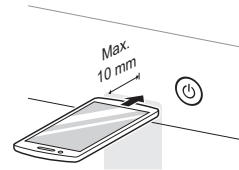

- 3 Press and hold the **Mode** button for 3 seconds or longer while continuing to hold your phone to the **Power** button.
- 4 Keep the phone in place until the tone transmission has finished. Once the tones have stopped, the diagnosis will be displayed in the application.

NOTE

- For best results, do not move the phone while the tones are being transmitted.

MAINTENANCE

⚠ WARNING

- Unplug the appliance before cleaning.
- Never use harsh chemicals, abrasive cleaners, or solvents to clean the appliance. They will damage the finish.

Regular Cleaning

Cleaning the Exterior

Proper care of your appliance can extend its life. The outside of the appliance can be cleaned with warm water and a mild, nonabrasive household detergent. Immediately wipe off any spills with a soft, damp cloth.

NOTE

- Do not use methylated spirits, solvents, or similar products.
- Never use steel wool or abrasive cleansers; they can damage the surface.

Cleaning the Interior

Wipe around the door opening and seal with a soft, damp cloth to prevent lint and dust buildup that could damage the door seal.

Clean the window with a soft cloth dampened with warm water and a mild, nonabrasive household detergent. Then wipe dry.

The stainless steel drum can be cleaned with a conventional stainless steel cleaner, used according to the manufacturer's specifications. Never use steel wool or abrasive cleansers; they may scratch or damage the surface.

Cleaning Around and Under the Appliance

Vacuum lint and dust from around the dryer and underneath it regularly.

Leaving the Door Open

After you finish using the appliance, leave the door open overnight to allow air to circulate and dry the drum. This helps prevent odors.

Cleaning the 3-Piece Lint Filter

⚠ CAUTION

- Refer to the following instructions for proper cleaning of the lint filter. Failure to do so can cause lint buildup on the condenser that can affect the drying performance.

NOTE

- Cleaning the lint filter will reduce drying time and energy consumption and prevent unnecessary malfunctions.
- Unload all of the clothes from the appliance before pulling out the lint filter.
- If you have pets or use dryer sheets, perform a thorough cleaning of the lint filters more often, using a vacuum cleaner or rinsing under running water.
- After cleaning the 3-piece lint filter, insert it back into place. The appliance will not operate without the lint filter in place.

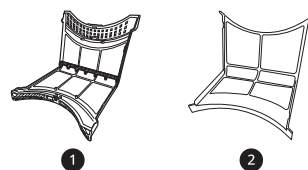

① Inner Filter Assembly (2 Filters)

- Clean both inner filters after every cycle.

② Outer Filter

- Clean the outer filter after drying 10 times or when lint has accumulated on the outer filter.

Cleaning the Inner Filter Assembly

- 1 Pull out the inner filter assembly from the outer filter.
 - Open the inner filter assembly by unfolding it in the direction of the arrow.

- Remove the small filter at the base by sliding it out of the grooves on each side.



- 2** Use your fingers to get most of the lint off the filters. To clean off residual lint, use a vacuum cleaner or rinse under running water.
- The filters must be completely dry before using or they could cause an unpleasant odor.

⚠ CAUTION

- Do not tap the large inner filter repeatedly as the built-in magnet may dislodge and cause a malfunction.

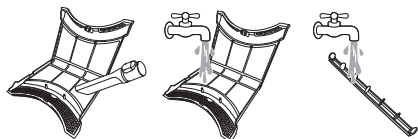

- 3** After drying both inner filters completely, reassemble the small filter by sliding the tabs at each side into the grooves on the large filter. Close the filter assembly by folding the sides back together and snapping them closed in the center.
- Ensure the left and right sides of the inner filter assembly are closed properly.

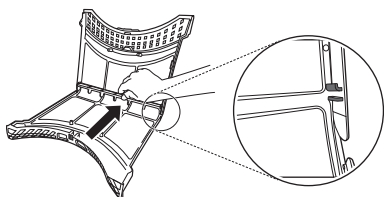

- 4** Insert the inner filter assembly into the outer filter.

Cleaning the Outer Filter

- 1** Remove the dust or lint around the filter inlet.

⚠ CAUTION

- If the lint drops into the filter inlet, it may affect the drying performance and increase drying time.

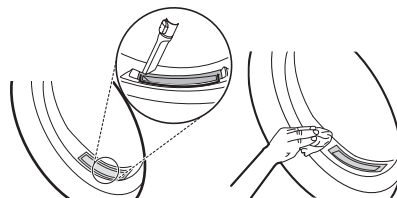

- 2** Pull out the outer filter.
- 3** Remove the inner filter.
- 4** Open the outer filter by grasping the top edge and unfolding the sides.
- 5** Remove the residual lint with a vacuum cleaner or by washing under running water.
- If washed, allow the filter to dry completely before use. Failure to do so may cause an odor.

⚠ CAUTION

- Do not tap the filter repeatedly as the built-in magnet may dislodge and cause a malfunction.

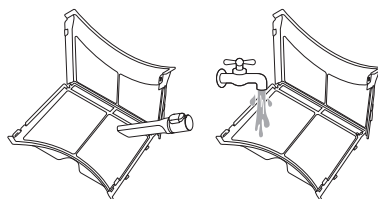

- 6** Reassemble the filters and reinsert them.

⚠ CAUTION

- Do not load or remove any clothes when the lint filter is not in place. The clothes can drop into the filter inlet and may cause the appliance to malfunction.
- For best results, always use all 3 parts of the 3-piece filter.

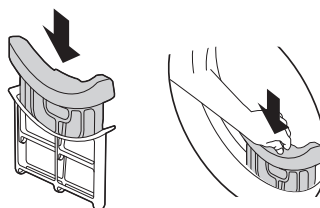

Using Drum Care Feature

Run the **Drum Care** cycle periodically to prevent unpleasant odors in the drum.

⚠ CAUTION

- Remove all of the clothes from the appliance.

- 1 Turn on the appliance.
- 2 Press the **Drum Care** button.
 - This function operates for about 3 hours.
- 3 After the cycle finishes, open the dryer door and leave it open to allow air to circulate in the drum.

⚠ WARNING

- For safety reasons, do not allow children or animals to climb into the appliance. Doing so could cause damage or injury.

Using Condenser Care Feature

The appliance automatically cleans built-up lint off of the condenser using water. If needed, the condenser can also be cleaned manually.

⚠ CAUTION

- Remove all of the clothes from the appliance.

- 1 Open the dryer door and pull out both the inner and outer filters.
- 2 After thoroughly cleaning the inner and outer filters, insert them into the filter inlet.
- 3 Turn on the appliance.
- 4 Press the **Condenser Care** button.
- 5 Press the **Start/Pause** button to start cleaning the condenser.
 - The condenser cleaning process takes about 1 hour.

- 6 Open the dryer door after the cleaning is finished and leave it open to allow air to circulate and thoroughly dry the drum.

⚠ WARNING

- For safety reasons, do not allow children or animals to climb into the appliance. Doing so could cause damage or injury.

Cleaning the Condenser

Refer to the following instructions for manually cleaning the condenser.

⚠ CAUTION

- To avoid physical injury and burns, do not touch or clean the condenser with bare hands.
- When cleaning the condenser, be careful not to damage the fins.

NOTE

- If drying performance deteriorates, open the condenser cover to check for foreign substances.

- 1 Press the top part of the access panel ① to open it.

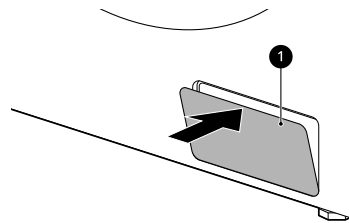

- 2 Turn the locks ② to release the condenser cover, and pull the cover to remove it.

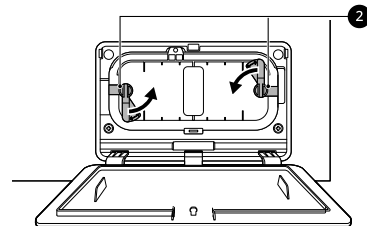

- 3 Clean the dust on the condenser using a vacuum cleaner or soft brush.

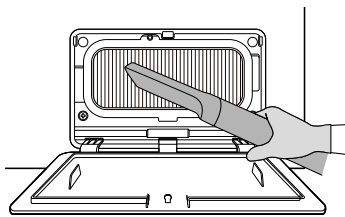

- 4** Reinsert and reassemble the condenser cover completely.

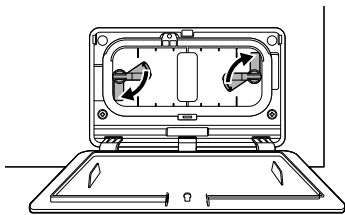

⚠ CAUTION

- If the condenser cover is not completely reassembled, the product will not work properly and may leak.

- 5** Check that the tab **3** on the bottom of the condenser cover is properly assembled into the opening **4** in the case.

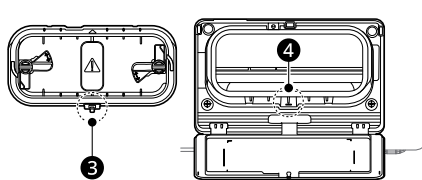

- 6** Close the access panel.

Care in Cold Climates

Thawing out the Accessories

⚠ CAUTION

- Wear gloves and take care to avoid burning yourself with hot water.

Frozen Water in Drain Hose

Wrap the drain hose in a towel soaked in hot water (140 °F / 60 °C).

Thawing out the Appliance Manually

- 1** Open the dryer door and pull out both the inner and outer filters.
- 2** Carefully pour 34 oz. (1 liter) of hot water at 140 °F / 60 °C into the lint filter compartment and then reinsert both lint filters.

⚠ CAUTION

- Pouring more than 51 oz. (1.5 liters) of water into the compartment will cause water to leak out.
- Wear gloves and use care when pouring hot water. 140 °F (60 °C) water can cause scalding or burns. Using water that is hotter than that can cause the appliance to malfunction.

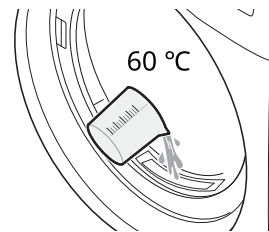

- 3** Turn on the appliance and run the **Normal** cycle for about 30 seconds. Then wait about 30 minutes.
- 4** Run the **Normal** cycle again. Check if the **UE** message appears within 10 minutes of starting the appliance.
 - If the **UE** message appears, go to step 2 and repeat the procedure.
 - If the **UE** message does not appear, the thawing process is done.
- 5** When thawing is complete, dry clothes as usual.

TROUBLESHOOTING

FAQs

Frequently Asked Questions

Q: When I press a button, why does my dryer beep and then nothing happens?

A: The Control Lock feature is turned on. To turn off **Control Lock**, turn the dryer on and press and hold the button that has **Control Lock** on or under it for 3 seconds.

Q: Why does my dryer take so long to dry clothes?

A: Proper airflow is critical to the efficient operation of clothes dryers. A lint filter which is full of lint or clogged with fabric softener sheet residue can reduce the airflow to the point that the time required to dry clothing will be greatly increased.

Q: Why does my dryer start by itself every few minutes?

A: This is how the Wrinkle Care feature works. The dryer runs briefly every few minutes for up to 2 hours after the cycle finishes. This feature is designed to help prevent wrinkles from setting in when the dryer is not unloaded immediately after the cycle is finished.

User Support Videos

For further assistance, there are videos and tutorials available through the lg.com website.

Scan this QR code to quickly access the video search page on the official LG website.

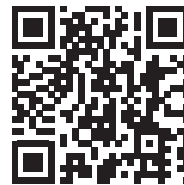

- 1** On the lg.com/us home page, click on the **Support** menu tab to bring up the menu selections. Select **Video Tutorials**.
- 2** Type **Dryer** in the search box on the new page and click the **Search** button.

Before Calling for Service

The dryer is equipped with an automatic error-monitoring system to detect and diagnose problems at an early stage. If the dryer does not function properly or does not function at all, check the following before you call for service.

For detailed information or videos, visit www.lg.com for the troubleshooting page.

Error Messages

Problem	Possible Cause & Solution
EE1, EE2, EE4, EE5, EE6 Temp sensor error	Temperature Sensor has malfunctioned. <ul style="list-style-type: none"> Unplug the power plug and call for service.
F1 Drum temp error	The temperature inside the drum has risen suddenly. <ul style="list-style-type: none"> Unplug the power plug and call for service.
LE1 Drum motor error	The motor has stopped suddenly. <ul style="list-style-type: none"> Check if the amount of clothing exceeds the maximum load capacity. Unplug the power plug and call for service.
LE2, RE Compressor error	The compressor has stopped suddenly. <ul style="list-style-type: none"> Unplug the power plug and call for service.
DE Pump error	The drain pump motor has malfunctioned. <ul style="list-style-type: none"> Unplug the power plug and call for service.
	The temperature at the installation location is below zero. <ul style="list-style-type: none"> The recommended surrounding temperature for installation is 41 - 95 °F (5 - 35 °C).
LE3 Fan motor error	The fan motor has stopped suddenly. <ul style="list-style-type: none"> Unplug the power plug and call for service.
LE3 Internal fan error	The internal fan has malfunctioned. <ul style="list-style-type: none"> Unplug the power plug and call for service.
1F Filter error	The lint filter is not in the appliance. <ul style="list-style-type: none"> Insert the lint filter.
CC Condenser cover error	The appliance is being operated without the condenser cover. <ul style="list-style-type: none"> Open the access panel and assemble the condenser cover.
P5 Low voltage	Power cord is connected incorrectly. <ul style="list-style-type: none"> Check the connection of the power cord to the terminal block.
1E	The water supply valve is closed. <ul style="list-style-type: none"> Open the water inlet valve connected to the dryer.
	The water is cut off. <ul style="list-style-type: none"> If there is a problem with the connected faucet, contact the appropriate repair company. If the whole house is out of water, contact the city hall or county office.
	The faucet or water supply hose is frozen. <ul style="list-style-type: none"> After turning off the faucet, use a hot wet towel to melt the consolidated parts of the faucet and both parts of the appliance water supply hose.
	The water supply hose is clogged. <ul style="list-style-type: none"> Remove the strainer from the water inlet to remove any debris.

Problem	Possible Cause & Solution
IE	The water supply hose is broken. <ul style="list-style-type: none"> Straighten the water inlet hose so that it does not bend.
	The water supply hose is not properly connected to the faucet. <ul style="list-style-type: none"> Tighten the water inlet hose again so that it is in close contact with the faucet.
drn No drainage	The drain hose is not connected properly. <ul style="list-style-type: none"> Connect the drain hose properly. Check if the drain hose is free of clogs or kinks and is not pinched behind or under the dryer.

Operation

Problem	Possible Cause & Solution
The appliance will not turn on.	Power cord is not properly plugged in. <ul style="list-style-type: none"> Make sure that the power plug is securely plugged into a grounded outlet matching the appliance's rating plate.
	House fuse is blown, circuit breaker has tripped, or power outage has occurred. <ul style="list-style-type: none"> Reset circuit breaker or replace fuse. Do not increase fuse capacity. If the problem is a circuit overload, have it corrected by a qualified electrician.
The appliance does not heat.	House fuse is blown, circuit breaker has tripped, or power outage has occurred. <ul style="list-style-type: none"> Reset circuit breaker or replace fuse. Do not increase fuse capacity. If the problem is a circuit overload, have it corrected by a qualified electrician.
	Selected cycle does not use heat. <ul style="list-style-type: none"> Some cycles default to unheated or air drying. Select a cycle that allows heated drying.
Water leaks.	The water container hose or the optional drain hose is not connected correctly. <ul style="list-style-type: none"> Connect the water container hose or the optional drain hose correctly.
	The door is closed while clothes or foreign substance is caught in the door. <ul style="list-style-type: none"> Check if clothes or foreign substance is caught in the door before using the appliance. If water leaks continuously, contact the LG Electronics Customer Information Center.
The appliance runs and pauses by itself after the drying cycle finishes.	This is normal operation for the Wrinkle Care option. <ul style="list-style-type: none"> Check to see if the Wrinkle Care option has been selected. The option is designed to prevent creases that are formed when the clothes are not unloaded promptly after the drying cycle. When the option is set, the appliance runs for 10 seconds and pauses for 5 minutes. The option runs for up to 2 hours.
Drying ended earlier than the initial control panel time.	The clothes are dried according to the Dry level or Dry mode setting. <ul style="list-style-type: none"> If the humidity or temperature in the drum reaches the product setting, the dry cycle may end earlier than the control panel time.
Clothes take too long to dry.	Load is not properly sorted. <ul style="list-style-type: none"> Separate heavy items from lightweight items. Larger and heavier items take longer to dry. Light items in a load with heavy items can fool the sensor because the light items dry faster.
	Large and heavy fabrics are loaded. <ul style="list-style-type: none"> Heavy fabrics take longer to dry because they tend to retain more moisture. To help reduce and maintain more consistent drying times for large and heavy fabrics, separate these items into smaller loads of a consistent size.
	Dryer controls are not set properly. <ul style="list-style-type: none"> Use the appropriate control settings for the type of load you are drying. Some loads may require an adjustment of the dry level setting for proper drying.

Problem	Possible Cause & Solution
Clothes take too long to dry.	Lint filter needs to be cleaned. <ul style="list-style-type: none"> Remove the lint from the filter before every load. With the lint removed, hold the filter up to a light to see if it is dirty or clogged. With some loads that produce high amounts of lint, such as new bath towels, it may be necessary to pause the cycle and clean the filter during the cycle. On models with a 3-piece lint filter, make sure to check, clean and reinstall both the inner and outer parts of the filter.
	House fuse is blown, circuit breaker has tripped, or power outage has occurred. <ul style="list-style-type: none"> Reset circuit breaker or replace fuse. Do not increase fuse capacity. If the problem is a circuit overload, have it corrected by a qualified electrician.
	The appliance is overloaded. <ul style="list-style-type: none"> Divide extra large loads into smaller loads for better drying performance and efficiency.
	Dryer is a heat-pump model. <ul style="list-style-type: none"> Heat-pump dryer models can take longer to dry clothes. However, compared to a conventional dryer, where the heater uses much more energy than the drum motor, a heat-pump dryer uses a more efficient heat exchanger and will generally use less energy overall, even during long cycles.
Drying time is not consistent.	Heat settings, load size, or dampness of clothing is not consistent. <ul style="list-style-type: none"> The drying time for a load will vary depending on the size of the load, the type of fabrics, the wetness of the clothes and the condition of the lint filter. An unbalanced load in the appliance can cause poor spinning, resulting in wetter clothes which will take longer to dry.

Performance

Problem	Possible Cause & Solution
Clothes are wrinkled.	Clothes dried too long (overdried). <ul style="list-style-type: none"> Overdrying a load of laundry can lead to wrinkled clothes. Try a shorter drying time or use a lower dry level setting and remove items while they still retain a slight amount of moisture.
	Clothes left in dryer too long after cycle ends. <ul style="list-style-type: none"> Use the Wrinkle Care option. This option will tumble the clothes briefly every few minutes for up to 3 hours to help prevent wrinkling.
Greasy or dirty spots on clothes.	Fabric softener used incorrectly. <ul style="list-style-type: none"> Check and follow the instructions provided with your fabric softener.
	Clean and dirty clothes are being dried together. <ul style="list-style-type: none"> Only use your dryer to dry clean items. Soil from dirty clothes can transfer to the clean clothes in the same or later loads.
	Clothes were not properly cleaned or rinsed before being placed in the dryer. <ul style="list-style-type: none"> Stains on dried clothes could be stains that were not removed during the washing process. Make sure that clothes are being completely cleaned or rinsed according to the instructions for your washer and detergent. Some difficult soils may require pre-treating prior to washing.
Clothes are shrinking.	Garment care instructions are not being followed. <ul style="list-style-type: none"> To avoid shrinking your clothes, always consult and follow fabric care instructions. Some fabrics will naturally shrink when washed. Other fabrics can be washed but will shrink when dried in a dryer. Use a low or no heat setting.

Problem	Possible Cause & Solution
Lint on clothes.	<p>Lint filter not cleaned properly.</p> <ul style="list-style-type: none"> Remove the lint from the filter before every load. With the lint removed, hold the filter up to a light to see if it is dirty or clogged. If it looks dirty, follow the cleaning instructions in the MAINTENANCE section. With some loads that produce high amounts of lint, it may be necessary to clean the filter during the cycle.
	<p>Laundry not sorted properly.</p> <ul style="list-style-type: none"> Some fabrics are lint producers (i.e., a fuzzy white cotton towel) and should be dried separately from clothes that are lint trappers (i.e., a pair of black linen pants).
	<p>Excess static in clothes.</p> <ul style="list-style-type: none"> Use a fabric softener to reduce static electricity. Be sure to follow the manufacturer's instructions. Overdrying a load of laundry can cause a buildup of static electricity. Adjust settings and use a shorter drying time.
	<p>The appliance is overloaded.</p> <ul style="list-style-type: none"> Divide extra large loads into smaller loads for drying.
	<p>Tissue, paper, etc., left in pockets.</p> <ul style="list-style-type: none"> Check pockets thoroughly before washing and drying clothes.
Excess static in clothes after drying.	<p>Fabric softener is not used or is used incorrectly.</p> <ul style="list-style-type: none"> Use a fabric softener, if available, to reduce static electricity. Be sure to follow the manufacturer's instructions.
	<p>Clothes dried too long (overdried).</p> <ul style="list-style-type: none"> Overdrying a load of laundry can cause a buildup of static electricity. Adjust settings and use a shorter drying time. Select a lower dry level setting on the selected cycle, if necessary.
	<p>Drying synthetics, permanent press, or synthetic blends.</p> <ul style="list-style-type: none"> These fabrics are naturally more prone to static buildup. Try using fabric softener, or use a lower dry level setting and/or shorter time settings.
Clothes have damp spots after drying.	<p>Very large load or very small load. Single large item such as a blanket or comforter.</p> <ul style="list-style-type: none"> If items are too tightly packed or too sparse the sensor may have trouble reading the dryness level of the load. Use a Timed Dry cycle for very small loads. Large, bulky items such as blankets or comforters can sometimes wrap themselves into a tight ball of fabric. The outside layers will dry and register on the sensors, while the inner core remains damp. When drying a single bulky item, it may help to pause the cycle once or twice and rearrange the item to unwrap and expose any damp areas. To dry a few remaining damp items from a very large load or a few damp spots on a large item after a sensor cycle has completed, empty the lint trap, and then set a Timed Dry cycle to finish drying the item(s).

Odors

Problem	Possible Cause & Solution
The appliance has an unpleasant odor.	<p>Are you using the appliance for the first time?</p> <ul style="list-style-type: none"> The odor is caused by the rubber material inside the appliance. The odor is normal when the appliance is new and disappears after you run several cycles.

Problem	Possible Cause & Solution
<p>The appliance has an unpleasant odor.</p>	<p>Do you smell an odor during use?</p> <ul style="list-style-type: none"> • Do not exceed the manufacturer's recommended amount of detergent when washing clothes. Excess detergent can build up on clothing and cause odors. • Leaving clothes in the washer or dryer after the cycle ends can lead to odors. Unload clothing promptly when the cycle ends. • Keep lint filters clean. Clogged or dirty lint filters can cause odors. After cleaning the lint filter, allow it to dry completely before using it. • For ventless models, leave the dryer door open after drying, or use the magnetic door stop (on some models) to keep the door slightly ajar. • If the odor is coming from the washer, follow the instructions in the product manual to clean the washer tub/drum. • Periodically run the Drum Care and Condenser Care cycles following the instructions in the MAINTENANCE section.

Wi-Fi

Problem	Possible Cause & Solution
<p>Trouble connecting appliance and smartphone to Wi-Fi network.</p>	<p>The password for the Wi-Fi network was entered incorrectly.</p> <ul style="list-style-type: none"> • Delete your home Wi-Fi network and begin the connection process again.
	<p>Mobile data for your smartphone is turned on.</p> <ul style="list-style-type: none"> • Turn off the Mobile data on your smartphone before connecting the appliance.
	<p>The wireless network name (SSID) is set incorrectly.</p> <ul style="list-style-type: none"> • The wireless network name (SSID) should be a combination of English letters and numbers. (Do not use special characters.)
	<p>The router frequency is not 2.4 GHz.</p> <ul style="list-style-type: none"> • Only a 2.4 GHz router frequency is supported. Set the wireless router to 2.4 GHz and connect the appliance to the wireless router. To check the router frequency, check with your Internet service provider or the router manufacturer.
	<p>The appliance and the router are too far apart.</p> <ul style="list-style-type: none"> • If the appliance is too far from the router, the signal may be weak and the connection may not be configured correctly. Move the router closer to the appliance or purchase and install a Wi-Fi repeater.
	<p>During Wi-Fi setup, the app is requesting a password to connect to the product (on certain phones).</p> <ul style="list-style-type: none"> • Locate the network name which starts with "LG" under Settings > Networks. Note the last part of the network name. <ul style="list-style-type: none"> - If the network name looks like LGE_Appliance_XX-XX-XX, enter lge12345. - If the network name looks like LGE_Appliance_XXXX, enter XXXX twice as your password. For example, if the network name appears as LGE_Appliance_8b92, then you would enter 8b928b92 as your password. In this instance, the password is case sensitive and the last 4 characters are unique to your appliance.

LIMITED WARRANTY

USA

TERMS AND CONDITIONS

ARBITRATION NOTICE: THIS LIMITED WARRANTY CONTAINS AN ARBITRATION PROVISION THAT REQUIRES YOU AND LG ELECTRONICS (“LG”) TO RESOLVE DISPUTES BY BINDING ARBITRATION INSTEAD OF IN COURT, UNLESS YOU CHOOSE TO OPT OUT. IN ARBITRATION, CLASS ACTIONS AND JURY TRIALS ARE NOT PERMITTED. PLEASE SEE THE SECTION TITLED “PROCEDURE FOR RESOLVING DISPUTES” BELOW.

Should your LG Dryer (“Product”) fail due to a defect in materials or workmanship under normal and proper use, during the warranty period set forth below, LG will, at its option, repair or replace the Product. This limited warranty is valid only to the original retail purchaser of the Product (“You”) and applies only when purchased lawfully and used within the United States including U.S. Territories.

WARRANTY PERIOD		
Period	Scope of Warranty	HOW SERVICE IS HANDLED
One (1) year from the date of original retail purchase, or from the date of delivery as per applicable law	Parts and Labor	LG will provide parts and labor to repair or replace defective parts.
Three (3) years from the date of original retail purchase, or from the date of delivery as per applicable law	Dryer drum	Parts only. Customer will be responsible for any labor or in-home service to replace defective parts.
Ten (10) years from the date of original retail purchase, or from the date of delivery as per applicable law	Dual Inverter Compressor Direct Drive Motor (Stator or Rotor)	Parts only. Customer will be responsible for any labor or in-home service to replace defective parts.

- Replacement Products and parts are warranted for the remaining portion of the original warranty period or ninety (90) days, whichever is greater.
- Replacement Products and parts may be new, reconditioned, refurbished, or otherwise factory remanufactured.
- Replaced Product or part(s) will be the property of LG.
- Proof of original retail purchase specifying the Product model and date of purchase is required to obtain warranty service under this limited warranty.

EXCEPT TO THE EXTENT PROHIBITED BY APPLICABLE LAW, ANY IMPLIED WARRANTY OF MERCHANTABILITY OR FITNESS FOR A PARTICULAR PURPOSE ON THE PRODUCT IS LIMITED IN DURATION TO THE DURATION OF THE ABOVE LIMITED WARRANTY. UNDER NO CIRCUMSTANCES SHALL LG OR ITS U.S. DISTRIBUTORS/DEALERS BE LIABLE FOR ANY INDIRECT, INCIDENTAL, CONSEQUENTIAL, SPECIAL, OR PUNITIVE DAMAGES, INCLUDING, WITHOUT LIMITATION, LOST GOODWILL, LOST REVENUES OR PROFITS, WORK STOPPAGE, IMPAIRMENT OF OTHER GOODS, COST OF REMOVAL AND REINSTALLATION OF THE PRODUCT, LOSS OF USE, OR ANY OTHER DAMAGES WHETHER BASED IN CONTRACT, TORT, OR OTHERWISE. LG’S TOTAL LIABILITY, IF ANY, SHALL NOT EXCEED THE PURCHASE PRICE PAID BY YOU FOR THE PRODUCT.

SOME STATES DO NOT ALLOW THE EXCLUSION OR LIMITATION OF INCIDENTAL OR CONSEQUENTIAL DAMAGES OR LIMITATIONS ON HOW LONG AN IMPLIED WARRANTY LASTS, SO THE ABOVE EXCLUSIONS OR LIMITATIONS MAY NOT APPLY TO YOU. THIS LIMITED WARRANTY GIVES YOU SPECIFIC LEGAL RIGHTS AND YOU MAY ALSO HAVE OTHER RIGHTS THAT VARY FROM STATE TO STATE.

THIS LIMITED WARRANTY DOES NOT COVER:

- Service trips to deliver, pick up, or install, educate how to operate, correct wiring, or correct unauthorized repairs.
- Damage or failure of the Product to perform during power failures and interrupted or inadequate electrical service.
- Damage or failure of the Product caused by leaky or broken water pipes, frozen water pipes, restricted drain lines, inadequate or interrupted water supply or inadequate supply of air.
- Damage or failure of the Product resulting from operating the Product in a corrosive atmosphere or contrary to the Product owner's manual.
- Damage or failure of the Product caused by accidents, pests and vermin, lightning, wind, fire, floods, acts of nature, or any other causes beyond the control of LG.
- Damage or failure of the Product caused by unauthorized modification or alteration, or if the Product is used for other than the intended purpose, or any water leakage where the Product was not properly installed.
- Damage or failure of the Product caused by incorrect electrical current, voltage, or plumbing codes.
- Damage or failure of the Product caused by transportation, storage, and/or handling, including scratches, dents, chips, and/or other damage to the finish of the Product, unless such damage is reported within one (1) week of delivery.
- Damage or failure of the Product resulting from misuse, abuse, improper installation, repair, or maintenance. Improper repair includes the use of parts not authorized by LG. Improper installation or maintenance includes installation or maintenance contrary to the Product owner's manual.
- Damage or failure of the Product caused by the use of parts, components, accessories, consumable cleaning products, or any other products or services that were not authorized by LG.
- Damage or missing items to any display or open box Product.
- Refurbished Product or any Product sold "As Is", "Where Is", "With all Faults", or similar disclaimer.
- Products with original serial numbers that have been removed, altered, or cannot be readily determined.
- Increases in utility costs and additional utility expenses.
- Any noises associated with normal operation.
- Products used for other than normal and proper household use (e.g., commercial, business, or industrial settings, including any retail or food service establishments, or any commercial lodging/transient rental setting), or any use contrary to the Product owner's manual.
- Costs associated with removal and reinstallation of the Product for repairs, or the removal and reinstallation of the Product if it is installed in an inaccessible location or not installed in accordance with the Product Owner's manual.
- Accessories, removable components, or consumable parts (e.g. Shelves, door bins, drawers, water/air filters, racks, light bulbs, batteries, etc., as applicable), except for internal/functional parts covered under this limited warranty.
- Conversion of product from natural gas or LP gas.

The cost of repair or replacement under these excluded circumstances shall be borne by You.

TO OBTAIN WARRANTY SERVICE AND ADDITIONAL INFORMATION

Call 1-800-243-0000 and select the appropriate option from the menu.

Or visit our website at <http://www.lg.com>

Or by mail: LG Electronics Customer Service P.O. Box 240007 Huntsville, AL 35813 ATTN: CIC

PROCEDURE FOR RESOLVING DISPUTES:

ALL DISPUTES BETWEEN YOU AND LG ARISING OUT OF OR RELATING IN ANY WAY TO THIS LIMITED WARRANTY OR THE PRODUCT SHALL BE RESOLVED EXCLUSIVELY THROUGH BINDING ARBITRATION, AND NOT IN A COURT OF GENERAL JURISDICTION. BINDING ARBITRATION MEANS THAT YOU AND LG ARE EACH WAIVING THE RIGHT TO A JURY TRIAL AND TO BRING OR PARTICIPATE IN A CLASS ACTION.

Definitions. For the purposes of this section, references to “LG” mean LG Electronics U.S.A., Inc., its parents, subsidiaries and affiliates, and each of their officers, directors, employees, agents, beneficiaries, predecessors in interest, successors, assigns and suppliers; references to “dispute” or “claim” shall include any dispute, claim or controversy of any kind whatsoever (whether based in contract, tort, statute, regulation, ordinance, fraud, misrepresentation or any other legal or equitable theory) arising out of or relating in any way to the sale, condition or performance of the product or this Limited Warranty.

Notice of Dispute. In the event you intend to commence an arbitration proceeding, you must first notify LG in writing at least 30 days in advance of initiating the arbitration by sending a letter to LG at LG Electronics, USA, Inc. Attn: Legal Department- Arbitration 111 Sylvan Avenue, Englewood Cliffs, NJ 07632. You and LG agree to engage in good faith discussions in an attempt to amicably resolve your claim. The notice must provide your name, address, and telephone number; identify the product that is the subject of the claim; and describe the nature of the claim and the relief being sought. If you and LG are unable to resolve the dispute within 30 days, either party may proceed to file a claim for arbitration.

Agreement to Binding Arbitration and Class Action Waiver. Upon failure to resolve the dispute during the 30 day period after sending written notice to LG, you and LG agree to resolve any claims between us only by binding arbitration on an individual basis, unless you opt out as provided below. Any dispute between you and LG shall not be combined or consolidated with a dispute involving any other person’s or entity’s product or claim. More specifically, without limitation of the foregoing, any dispute between you and LG shall not under any circumstances proceed as part of a class or representative action. Instead of arbitration, either party may bring an individual action in small claims court, but that small claims court action may not be brought on a class or representative basis.

Arbitration Rules and Procedures. To begin arbitration of a claim, either you or LG must make a written demand for arbitration. The arbitration will be administered by the American Arbitration Association (“AAA”) and will be conducted before a single arbitrator under the AAA’s Consumer Arbitration Rules that are in effect at the time the arbitration is initiated (referred to as the “AAA Rules”) and under the procedures set forth in this section. The AAA Rules are available online at www.adr.org/consumer. Send a copy of your written demand for arbitration, as well as a copy of this provision, to the AAA in the manner described in the AAA Rules. You must also send a copy of your written demand to LG at LG Electronics, USA, Inc. Attn: Legal Department- Arbitration 111 Sylvan Avenue, Englewood Cliffs, NJ 07632. If there is a conflict between the AAA Rules and the rules set forth in this section, the rules set forth in this section will govern. This arbitration provision is governed by the Federal Arbitration Act. Judgment may be entered on the arbitrator’s award in any court of competent jurisdiction. All issues are for the arbitrator to decide, except that issues relating to the scope and enforceability of the arbitration provision and to the arbitrability of the dispute are for the court to decide. The arbitrator is bound by the terms of this provision.

Governing Law. The law of the state of your residence shall govern this Limited Warranty and any disputes between us except to the extent that such law is preempted by or inconsistent with applicable federal law.

Fees/Costs. You do not need to pay any fee to begin an arbitration. Upon receipt of your written demand for arbitration, LG will promptly pay all arbitration filing fees to the AAA unless you seek more than \$25,000 in damages, in which case the payment of these fees will be governed by the AAA Rules. Except as otherwise provided for herein, LG will pay all AAA filing, administration and arbitrator fees for any arbitration initiated in accordance with the AAA Rules and this arbitration provision. If you prevail in the arbitration, LG will pay your attorneys’ fees and expenses as long as they are reasonable, by considering factors including, but not limited to, the purchase amount and claim amount. Notwithstanding the foregoing, if applicable law allows for an award of reasonable attorneys’ fees and expenses, an arbitrator can award them to the same extent that a court would. If the arbitrator finds either the substance of your claim or the relief sought in the demand is frivolous or brought for an improper purpose (as measured by the standards set forth in Federal Rule of Civil Procedure 11(b)), then the payment of all arbitration fees will be governed by the AAA Rules. In such a situation, you agree to reimburse LG for all monies previously disbursed by it that are otherwise your obligation to pay under the AAA Rules. Except as otherwise provided for, LG waives any rights it may have to seek attorneys’ fees and expenses from you if LG prevails in the arbitration.

Hearings and Location. If your claim is for \$25,000 or less, you may choose to have the arbitration conducted solely on the basis of (1) documents submitted to the arbitrator, (2) through a telephonic hearing, or (3) by an in-person hearing as established by the AAA Rules. If your claim exceeds \$25,000, the right to a hearing will be determined by the AAA Rules. Any in-person arbitration hearings will be held at a

location within the federal judicial district in which you reside unless we both agree to another location or we agree to a telephonic arbitration.

Opt Out. You may opt out of this dispute resolution procedure. If you opt out, neither you nor LG can require the other to participate in an arbitration proceeding. To opt out, you must send notice to LG no later than 30 calendar days from the date of the first consumer purchaser's purchase of the product by either: (i) sending an e-mail to optout@lge.com, with the subject line: "Arbitration Opt Out" or (ii) calling [1-800-980-2973](tel:1-800-980-2973). You must include in the opt out e-mail or provide by telephone: (a) your name and address; (b) the date on which the product was purchased; (c) the product model name or model number; and (d) the serial number (the serial number can be found (i) on the product; or (ii) online by accessing <https://www.lg.com/us/support> and clicking on "How do I find my model number?").

You may only opt out of the dispute resolution procedure in the manner described above (that is, by e-mail or telephone); no other form of notice will be effective to opt out of this dispute resolution procedure. Opting out of this dispute resolution procedure will not affect the coverage of the Limited Warranty in any way, and you will continue to enjoy the full benefits of the Limited Warranty. If you keep this product and do not opt out, then you accept all terms and conditions of the arbitration provision described above.

Memo



LG Customer Information Center

For inquiries or comments, visit **www.lg.com** or call:

1-800-243-0000 U.S.A.

1-888-542-2623 CANADA

Register your product Online!

www.lg.com

Centro de Información al Cliente LG

Para consultas o comentarios, visite **www.lg.com** o llame por teléfono:

1-800-243-0000 EE.UU.

1-888-542-2623 CANADÁ

¡Registre su producto en línea!

www.lg.com

Centre de Service à la Clientèle de LG

Pour des questions ou des commentaires, visitez **www.lg.com/ca_fr** ou appelez :

1-800-243-0000 ÉTATS-UNIS

1-888-542-2623 CANADA

Enregistrez votre produit en ligne!

www.lg.com/ca_fr