

EN

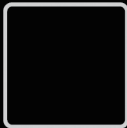
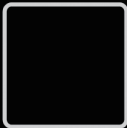
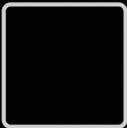

Thank you for purchasing a Candy Product.

Please read these instructions carefully before using this appliance. The instructions contain important information which will help you get the best out of the appliance and ensure safe and proper installation, use and maintenance.

Keep this manual in a convenient place so you can always refer to it for the safe and proper use of the appliance.

If you sell the appliance, give it away, or leave it behind when you move house, make sure you also pass on this manual so that the new owner can become familiar with the appliance and safety warnings.

Legend



Warning - Important Safety information



General information and tips



Environmental information

NOTE:FOR U.K. ONLY



On receipt of your appliance please check it carefully for damage. Any damage found must be reported to the delivery driver immediately. Alternatively damage found must be reported to the retailer within 2 days of receipt.



Environmental conditions

This appliance is marked according to the European directive 2012/19/EU on Waste Electrical and Electronic Equipment (WEEE).

WEEE contains both polluting substances (which can cause negative consequences for the environment) and basic components (which can be re-used). It is important to have WEEE subjected to specific treatments, in order to remove and dispose properly all pollutants, and recover and recycle all materials. Individuals can play an important role in ensuring that WEEE does not become an environmental issue; it is essential to follow some basic rules:

- WEEE should not be treated as household waste;
- WEEE should be handed over to the relevant collection points managed by the municipality or by registered companies. In many countries, for large WEEE, home collection could be present.

In many countries, when you buy a new appliance, the old one may be returned to the retailer who has to collect it free of charge on a one-to-one basis, as long as the equipment is of equivalent type and has the same functions as the supplied equipment.



WARNING!

Risk of injury or suffocation!

Disconnect the appliance from the mains supply. Cut off the mains cable and dispose of it. Remove the door catch to prevent children and pets to get closed in the appliance.

This manual is based on **“EWY 485SW6-S,EWY 485SB8-S,EWY 485SG6-S”**

1- Safety information	4
2- Installation.....	7
3- Practical hints.....	11
4- Product description.....	13
5- Control panel.....	14
6- Programmes	17
7- Consumption	20
8- Daily use	21
9- Care and cleaning	26
10- Troubleshooting	29
11- Technical data	32
12- Customer service	33

Before switching on the appliance for the first time read the following safety hints!



WARNING!

Daily use

- ▶ This appliance is intended to be used in household and similar applications such as:
 - Staff kitchen areas in shops, offices and other working environments;
 - Farm houses;
 - By clients in hotels, motels and other residential type environments;
 - Bed and breakfast type environments.

A different use of this appliance from household environment or from typical housekeeping functions, as commercial use by expert or trained users, is excluded even in the above applications. If the appliance is used in a manner inconsistent with this it may reduce the life of the appliance and may void the manufacturer's warranty. Any damage to the appliance or other damage or loss arising through use that is not consistent with domestic or household use (even if located in a domestic or household environment) shall not be accepted by the manufacturer to the fullest extent permitted by law.

- ▶ This appliance can be used by children aged from 8 years and above and persons with reduced physical, sensory or mental capabilities or lack of experience and knowledge if they have been given supervision or instruction concerning use of the appliance in a safe way and understand the hazards involved.

Children shall not play with the appliance. Cleaning and user maintenance shall not be made by children without supervision.

- ▶ Children should be supervised to ensure that they do not play with the appliance.
- ▶ Children of less than 3 years should be kept away unless continuously supervised.
- ▶ If the supply cord is damaged, it must be replaced by a special cord or assembly available from the manufacturer or its service agent.

- ▶ Only use the hose-sets supplied with the appliance for the water supply connection (do not reuse old hose-sets).
- ▶ Water pressure must be between 0.03 MPa and 1 MPa.
- ▶ Make sure carpets or rugs do not obstruct the base or any of the ventilation openings.
- ▶ After installation, the appliance must be positioned so that the plug is accessible.
- ▶ The maximum load capacity of dry clothes depends on the model used (see control panel).
- ▶ To consult the product technical specification please refer to the manufacturer website.

Electrical connections and safety instructions

- ▶ The technical details (supply voltage and power input) are indicated on the product rating plate.
- ▶ Make sure that the electrical system is earthed, complies with all applicable law and that the (electricity) socket is compatible with the plug of the appliance. Otherwise, seek qualified professional assistance.
- ▶ The use of converters, multiple sockets or extension cords is strongly advised against.
- ▶ Before cleaning or maintaining the washing machine, unplug the appliance and turn off the water tap.
- ▶ Do not pull on the power cord or appliance to unplug the machine.
- ▶ Make sure there is no water in the drum before opening the door.



WARNING!

Water may reach very high temperatures during the wash cycle.

- ▶ Do not expose the washing machine to rain, direct sunlight or other weather elements. Protect from possible freezing.
- ▶ When moving, do not lift the washing machine by the knobs or detergent drawer; during transport, never rest the door on the trolley. We recommend two people lift the washing machine.
- ▶ In the event of fault and/or malfunction, turn off the washing machine, close the water tap and do not tamper with the appliance. Immediately contact the customer service centre and only use original spare parts. Failure to observe these instructions may jeopardise appliance safety.

Intended use

This appliance is intended for washing machine-washable laundry only. Anytime follow the instructions given on the label of each garment label. It is designed exclusively for domestic use inside the house. It is not intended for commercial or industrial use.

Changes or modifications to the device are not allowed. Unintended use may cause hazards and loss of all warranty and liability claims.

2.1 Preparation

- ▶ Make sure there is no transport damage.
- ▶ Make sure all transport bolts are removed.
- ▶ Handle the appliance always with at least two persons because it is heavy.
- ▶ Take the appliance out of the packaging.
- ▶ Remove all packaging material including protecting film on cabinet, polystyrene base, keep them out of children's reach. While opening the package, water drops may be seen on plastic bag and porthole. This normal phenomenon results from water tests in the factory.



Note: Packaging disposal

Keep all packaging materials out of children's reach and dispose them in an environmentally friendly manner.

2.2 OPTIONAL: Install noise reduction pads

1. When opening the shrink package, you will find four noise reduction pads. These are used for reducing noise (Fig. 2-1).
2. Lay the washing machine down to its side, porthole pointing upwards, bottom side towards operator.
3. Take out the noise reduction pads and remove the double-sided adhesive protective film; paste around the bottom; the noise reduction pads under the washing machine cabinet as shown in Figure 3 (two longer pads in position 1 and 3, two shorter pads in position 2 and 4). Finally set the machine upright again.

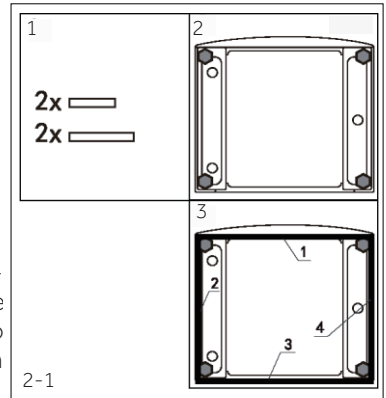

2.3 Dismantle the transportation bolts

The transport protection on the rear side is designed for clamping anti-vibration components inside the appliance during transportation to prevent inner damage. All elements (T1, T2, T3 and T4, Fig 2-2) must be removed before use.

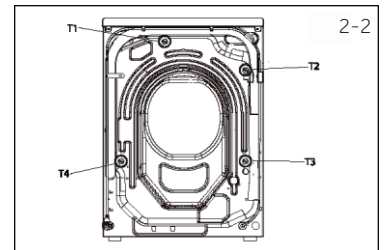

1. Remove all 4 packing bolts (T1-T4) (Fig.2-3).
2. Fill the 5 holes with blanking plugs.

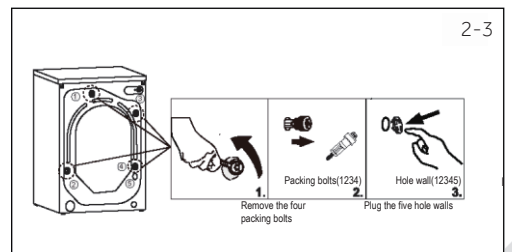

Note: Keep in safe place

Keep all parts of the transport protection in a safe place for later use. Whenever the appliance is to be moved at first reinstall the protection parts.

2.4 Moving the appliance

If the machine is to be moved to a distant location, replace the transportation bolts removed before installation to prevent damage: The assembly takes place in reverse order.

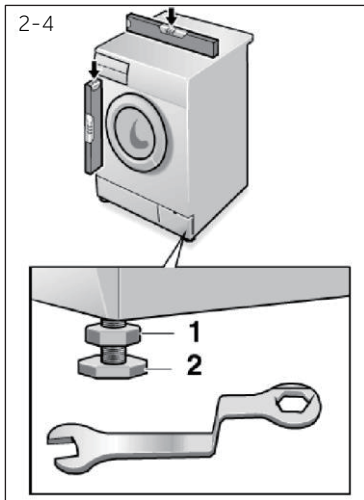

2.5 Aligning the appliance

Adjust all feet (Fig.2-4) to achieve a complete level position. This will minimize vibrations and thus noise during use. It will also reduce wear and tear. We recommend to use a spirit level for adjustment. Floor should be as stable and flat as possible.

1. Loose the locknut (1) by using a wrench.
2. Adjust the height by turning the feet.(2).
3. Tighten locknut (1) against the housing.

2.6 Aligning the appliance

Fix the water drain hose properly to the piping. The hose has to reach at one point a height between 80 and 100 cm above the appliance bottom line! if possible keep always drain hose fixed to the clip at the appliance back.



WARNING!

- ▶ Use only the supplied hose set for the connection.
- ▶ Never reuse old hose sets!
- ▶ Only connect to cold water supply.
- ▶ Before connection, check whether the water is clean and clear.

Following connections are possible:

2.6.1 Drain hose to sink

- ▶ Hang the drain hose with the U-support over the edge of a sink with adequate size (Fig. 2-5).
- ▶ Protect the U-support sufficiently against slipping.

2.6.2 Drain hose to waste water connection

- ▶ The internal diameter of the stand pipe with vent-hole must be minimum 40 mm.
- ▶ Put the drain hose for 80-100 mm in the wastewater pipe.
- ▶ Attach the U-support and secure it sufficiently (Fig. 2-6).

2.6.3 Drain hose to sink connection

- ▶ The junction must lie above the siphon.
- ▶ A spigot connection is usually closed by a pad (A). That must be removed to prevent any disfunction (Fig. 2-7).
- ▶ Secure the drain hose with a clamp.

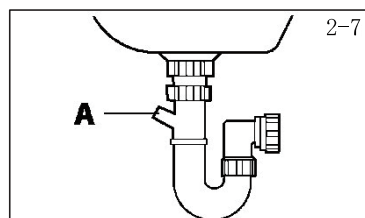
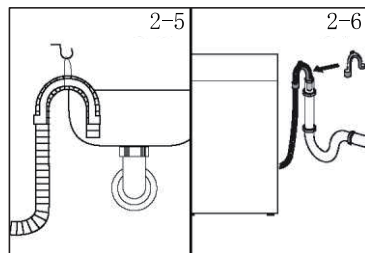

CAUTION!

- ▶ The drain hose should not be submerged in water and should be securely fixed and leak-free. If the drain hose is placed on the ground or if the pipe is at a height of less than 80 cm, the washing machine will continuously drain while being filled (self-siphoning).
- ▶ Drain hose is not to be extended. If necessary contact after sales service.
- ▶ Do not remove the drainage pipe clamp.

2.7 Drain hose to sink connection

Make sure that the gaskets are inserted.

1. Connect the water inlet hose with the angled end to the appliance (Fig.2-8). Tighten the screw Joint by hand.
2. The other end connects to a water tap with a 3/4 thread (Fig.2-9).

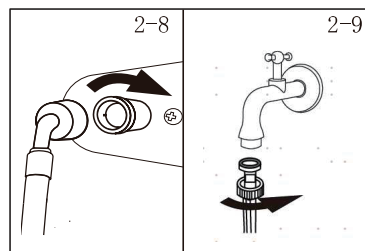

2-10

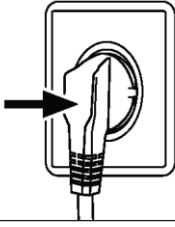

2.8 Electrical Connection

Before each connection check if:

- ▶ power supply, socket and fusing are appropriate to the rating plate.
- ▶ the power socket is earthed and no multi-plug or extension are used.
- ▶ the power plug and socket are strictly according.
- ▶ **Only UK:** The UK plug meets BS1363A standard.

Put the plug into the socket (Fig. 2-10).



WARNING!

- ▶ Ensure always that all connections (power supply, drain and fresh water hose) are firm, dry and leak free!
- ▶ Take care these parts are never to be crushed, kinked, or twisted.
- ▶ If the supply cord is damaged, it must be replaced by the service agent (see warranty card) in order to avoid a hazard.

3.1 Load tips

When sorting laundry, make sure:

- have eliminated metallic objects such as hair clips, pins, coins, from laundry;
 - to have buttoned pillow cases, closed zips, tied loose belts and long robe ribbons;
 - to have removed rollers, hooks or clips from curtains;
 - to have carefully read clothing washing labels;
 - to have removed any persistent stains using specific detergents.
- ▶ When washing rugs, bedcovers or other heavy clothing, we recommend you avoid the spinning cycle.
 - ▶ To wash wool, make sure the item can be machine washed. Check the fabric label.
 - ▶ Leave the appliance's door slightly open between washes, to prevent possible bad smells developing inside the machine.

3.2 Useful advice for saving

Tips on how to save money and not damage the environment when using your appliance.

- ▶ Load the machine with suggested capacity shown in the programme table for each programme - this will allow you to save energy and water.
- ▶ Noise and residual laundry moisture are affected by spin speed: a faster spin is associated with greater noise and lower residual moisture in the laundry.
- ▶ The most efficient programmes in terms of combined use of water and energy are usually the longer-lasting ones with lower temperature.
- ▶ Scan QR code on energy label for energy consumption information. The actual energy consumption may differ from the declared one according to local conditions.

Maximise the load size

- ▶ Achieve the best use of energy, water, detergent and time by using the recommended maximum load size.
Save up to 50% energy by washing a full load instead of 2 half loads.

Do you need to pre-wash?

- ▶ For heavily soiled laundry only!
Save detergent, time, water and energy consumption by not selecting prewash for slight to normally soiled laundry.

Is a hot wash required?

- ▶ Pretreat stains with stain remover or soak dried in stains in water before washing to reduce the necessity of a hot wash programme. Save energy by using a low temperature wash programme.

3.3 Dosing the detergent

Below is a short guide with tips and advice on the use of detergent

- ▶ Only use detergents suitable for washing machine.
- ▶ Select your detergent according to the type of fabric (cotton, delicates, synthetics, wool, silk, etc.), the colour, the type and level of soiling and the programmed washing temperature.
- ▶ To use the right amount of detergent, softener or any other additives, carefully follow

the manufacturer's instructions every time: correctly using the appliance with the right dose allow you to avoid waste and to reduce the environmental impact.

i When washing heavily soiled whites, we recommend using cotton programs of 60°C or above and a normal washing powder (heavy duty) that contains bleaching agents that at medium/high temperatures provide excellent results. For washes between 40°C and 60°C the type of detergent used needs to be appropriate for the type of fabric and level of soiling. Normal powders are suitable for "white" or colour fast fabrics with high soiling, while liquid detergents or "colour protecting" powders are suitable for coloured fabrics with light levels of soiling.

For washing at temperatures below 40°C, we recommend the use of liquid detergents or detergents specifically labeled as suitable for low temperature washing.

For washing wool or silk, only use detergents specifically formulated for these fabrics.

- ▶ Too much detergent leads to excessive foam, which prevents the cycle being carried out correctly. It could also affect the quality of the washing and rinsing.

The use of ecological detergents without phosphates may cause the following effects:

- **cloudier rinse drain water:** This effect is tied to the suspended zeolites which do not have negative effects on rinse efficiency.
- **white powder (zeolites) on laundry at the end of the wash:** this is normal, the powder is not absorbed by fabric and does not change its colour.
To remove the zeolites, select a rinse programme. In the future consider using slightly less detergent.
- **foam in the water at last rinse:** this does not necessary indicate poor rinsing. Consider using less detergent in future washes.
- **abundant foam:** This is often due to the anionic surfactants found in the detergents which are hard to eliminate from laundry.

In this case, do not re-rinse to eliminate these effects. It is invalid.

We suggest conducting a maintenance wash using a proprietary cleaner.

If the problem persists or if you suspect a malfunction, immediately contact an Authorised Customer Service Centre.



Note:

Due to technical changes and different models, the illustrations in the following chapters may differ from your model.

4.1 Picture of appliance

Front (Fig. 4-1):

Rear side (Fig. 4-2):

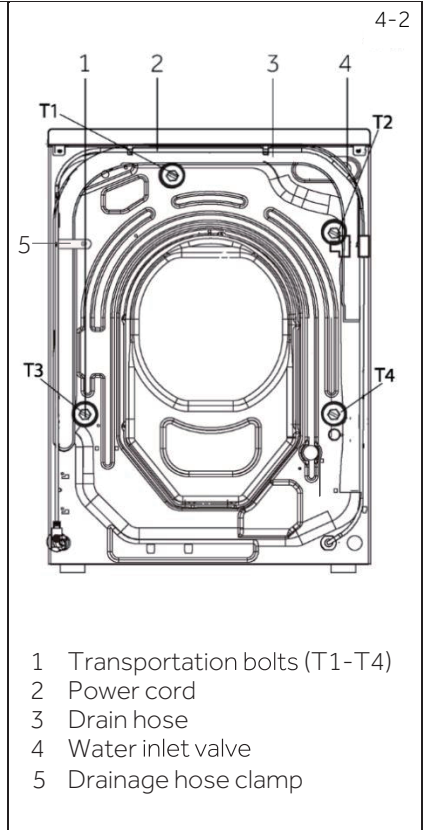
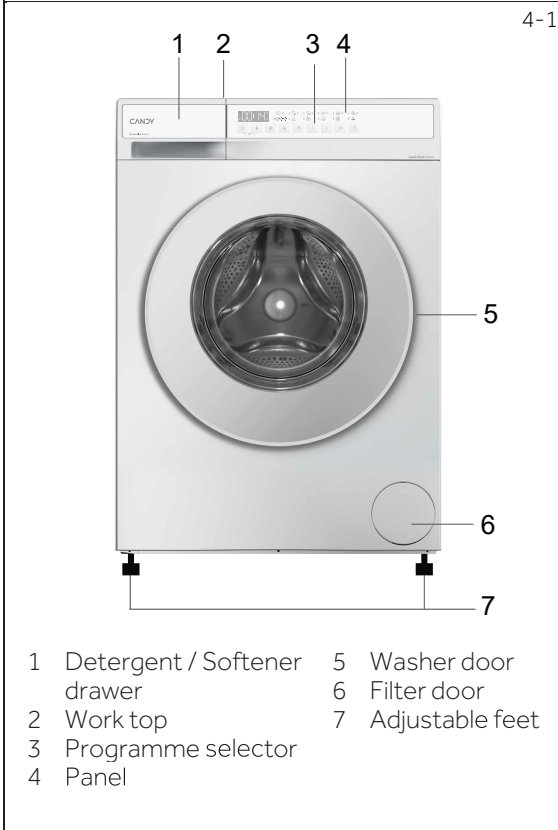

4.2 Accessories

Check the accessories and literature in accordance with this list (Fig. 4-3):

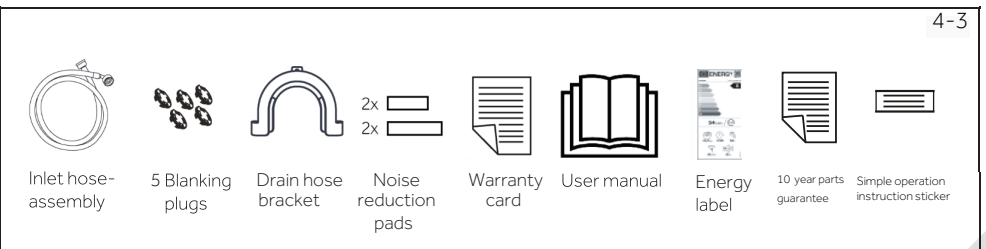

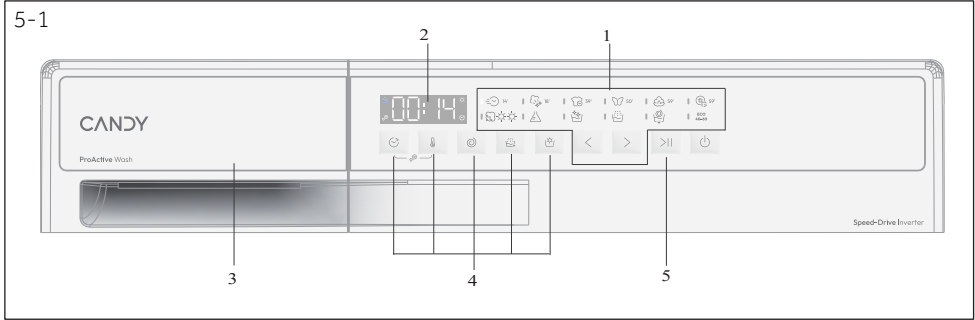

- | | | |
|----------------------|------------------------------|------------------------|
| 1 Programme selector | 3 Detergent /Softener drawer | 5 "Start/Pause" button |
| 2 Display | 4 Function buttons | |

i Note: Acoustic signal

The acoustic signal can be selected or canceled if necessary; see DAILY USE (see P27 8.12).



5.1 Power button

Turn on/ off the machine through this power button (Fig.5-2).

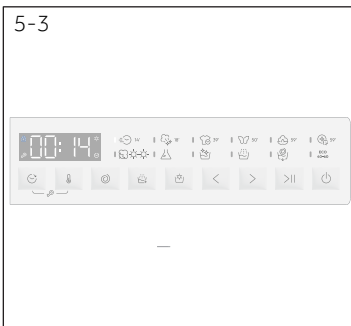

5.2 Programme selector

By pressing the left and right buttons of the program (Figure 5-3), you can select one of the 12 programs and display its default Settings.

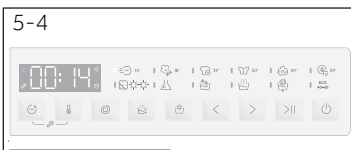

5.3 Display

The display (Fig.5-4) shows following information:

- ▶ Remaining time
- ▶ Reservation remaining time
- ▶ Alarm information and prompt information
- ▶ Pause end information
- ▶ Delay time

5.4 Detergent drawer

Open dispenser drawer, the following components can be seen (Fig. 5-5):

- 1: Compartment for powder or liquid detergent.
 - 2: Lock tab, press it down to pull out dispenser drawer.
 - 3: Put a small amount of washing powder.
 - 4: Compartment for softener.
 - 5: Lock tab, press it down to pull out dispenser drawer.
- The recommendation on the type of detergents is suitable for the various washing temperatures, please refer to the manual of detergent (see P23).

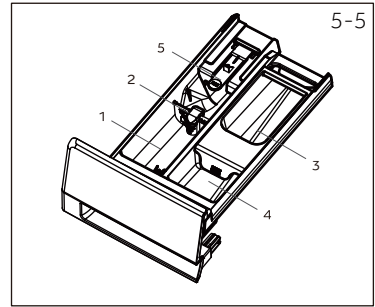

5.5 Function buttons

The function buttons (Fig 5-6) enable additional options in the selected programme before programme starts. The related indicators are displayed.

By switching off the appliance or setting a new programme, all options are displayed.

If a button has multiple options, the desired option can be selected by pressing the button sequentially.

By touching the buttons, when it is in dull light, the function is unselected; when it is in bright light, the function is selected.

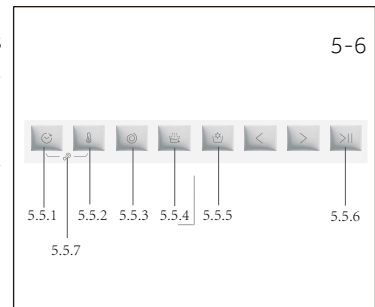

Note: Factory settings

To get best results in each programme, Candy has defined specific default settings. If there is no special requirement, default setting are recommended.

5.5.1 Function button "☺"

- This delay button allows you to preprogramme the wash cycle to with a maximum of 24 hours delay.(Fig.5-7)
- To delay the start using the following procedures:
 - Select the required programme.
 - Press the button once to activated the delay start and then press it again to set the desired delay.The delay increases in steps of 30 minutes,with a maximum of 24 hours delay.
 - Confirm by pressing the "Start/Pause" button. The delay countdown begin and when it has finished, the programme will start automatically.
- It is possible to cancel the delay start by turning the programme selector.

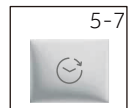

5.5.2 Function button "🌡"

- Touch this temperature button(Fig.5-8) to display the corresponding temperature. If "-- C " is selected, the water will not be heated.

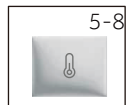

5-9



5.5.3 Function button "🔄"

- Touch this speed button (Fig.5-9) to change or deselect the spin speed of the program. If no light is illuminated and display "0", the appliance will not spin.

5-10



5.5.4 Function button "🧺+"

- This button is extra rinse(Fig.5-10). It allows you to add at least one rinse at the end of washing cycle.(Some programmes do not have this function.) It is useful for people with delicate and sensitive skin, for which a small amount of residue may cause allergies. It is advisable to use this program for children clothes and for the washing of heavily soiled items, which require a whose fibre large amount of detergent or for the washing of toweling items, have the tendency to hold the detergent.

5-11



5.5.5 Function button "🧺☀️"

- This button (Fig.5-12) to select the drying function. Continuous pressing can select different drying intensities and times. This button can only be selected by some programs, and cannot be selected when the program light is off.

5-12



5.5.6 Function button ">||"











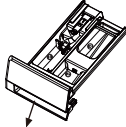



- Touch this button (Fig.5-12) gently to start or interrupt the currently displayed programme.

5-13



5.5.7 Function button "😊🌡️"

- Press the "Delay" and "Temperature" button (Fig.5-13) simultaneously to activate the child lock mode.

<ul style="list-style-type: none"> ● Yes ○ Optional / No 								Detergent compartment for: <ul style="list-style-type: none"> 1 Detergent 2 Softener or care product 3 Prewash 			<ul style="list-style-type: none"> ✓ Selectable but not default ✗ Not selectable default 			
														 MAX KG 8KG
	14'	RAPID	1	1	30	30	800	1400	●	○	/	✓	✓	✓
	18'	FRESH VAPOR	1	-	-	-	-	-	/	/	/	✗	✗	✗
	39'	SPECIAL 39'	4	4	30	30	800	1400	●	○	/	✓	✓	✓
	50'	DELICATE	2	-	30	40	400	400	●	○	/	✗	✗	✓
	59'	COTTON	8	5	30	90	1400	1400	●	○	/	✓	✓	✓
	59'	HYGIENE PLUS 59'	1.5	1	60	90	1400	1400	●	○	/	✓	✗	✓
		HIGH HEAT	-	5	-	-	-	-	/	/	/	✓	✗	✗
		SYNTHETICS	5.5	3.5	40	60	1200	1200	●	○	/	✓	✓	✓
		DRUM CLEAN	-	-	90	90	-	-	/	/	/	✗	✗	✗
		RINSE	8	5	-	-	1000	1000	/	○	/	✓	✗	✗
		DRAIN&SPIN	8	5	-	-	1000	1400	/	/	/	✓	✗	✗
	ECO 1) 40-60	ECO 40-60	8	5	40	90	1400	1400	●	○	/	✓	✓	✓

INFORMATION FOR THE TEST LABORATORIES
 STANDARD PROGRAMME ACCORDING TO (EU) No 2019/2023: ECO 40-60 PROGRAMME

1) Eco 40-60 changed the program name to cotton after changing the parameters.

Description of programmes

To clean different types of fabrics and various levels of dirt, the washing machine has specific programs to meet every need of washing (see table of programmes).



Choose programme in accordance with the laundry instructions appearing on labels, especially the maximum recommended temperature.



WARNING!

IMPORTANT WASH PERFORMANCE ADVICE.

- ▶ New, coloured garments should be washed separately for at least 5 or 6 washes.
- ▶ Certain large dark items such as jeans and towels should always be washed separately.
- ▶ Never mix NON COLOURFAST fabrics.
- ▶ Do not touch the observe window glass when the high temperature program is operating.

ECO 40-60

The ECO 40-60 programme is able to clean normally dirty cotton laundry declared to be washable at 40°C to 60°C, together in the same cycle. This programme is used to assess the compliance with the EU Ecodesign legislation (environmentally friendly products design).

SYNTHETICS

This programme allows you to wash different fabrics and different colours all together. The rotation movement of the drum and the water levels are optimized, both during the washing rinsing phase. The accurate spin action ensures a reduced formation of creases in the fabrics.

DRUM CLEAN

This program can carry out the self-cleaning of the washing machine. We recommend a bucket self-cleaning after using the washing machine for 50 times. When using this program, please do not use any clothes detergent or machine cleaner.

RINSE

This program performs 2 rinses with an intermediate spin (which can be reduced or excluded by using the appropriate button). It is used for rinsing any type of fabric, for example after a wash carried out by hand.

DRAIN&SPIN

The program completes the drain and a maximum spin. It is possible to delete or reduce the spin through the spin selection button.

SPECIAL 39'

This programme allows you to wash different fabrics together such as cottons, synthetics and mixed fabrics in only 39 minutes at 30°C (or less) temperature. This programme is particularly suited to slightly dirty fabrics, up to half of nominal load.

RAPID

This new programme may be used to obtain excellent results while saving water, energy, detergent and time. This option washes at a medium temperature suitable for lightly dirty mixed laundry of cotton and synthetic. Recommended for small loads and lightly dirty items.

FRESH VAPOR

This programme uses a steam treatment to relax creases. It is designed for dry garments and depending on the type of fabrics.

HIGH HEAT

High temperature drying programme recommended for cottons and linen items (always refer to the laundry care label).

HYGIENE PLUS 59'

This washing programme is capable of reaching a temperature of 60°C for an extended period of time, combining the steam action with a powerful rinsing action for thoroughly clean and hygienic clothing. Recommended for cotton fabrics.

COTTON

This programme is suitable for washing coloured cotton garments at 40°C or for ensuring the highest degree of cleanliness for cotton resistant laundry washing at 90°C. The final spin is at maximum speed that ensures excellent dehydration effect.

DELICATE

Developed to take good care of delicate items, this programme washes at a low temperature in short time. An extended, in - depth rinse nourishes fabric fibres.



Note: The procedure to check the number of cycle that the machine has run.

Procedure: under "COTTON" programme, press "TEMPERATURE" and "SPEED" simultaneously, it will display the number of running cycle for 2 seconds, and then back to "COTTON" programme. The cumulativer running cycles will add after the programme ending. The running cycle will be displayed in hexademical. It is over 9999.

7-Consumption

EN





Scan QR code on energy label for energy consumption information. The actual energy consumption may differ from the declared one according to the local conditions.



Note: Auto Weight

The appliance is equipped with a loading recognition. At low loading, energy, water and washing time will be reduced automatically in some programmes. The display default time may vary depending on the load weight, involving the "ECO 40-60, Synthetics, Hygiene Plus59', Cotton and Delicate".

Indicative information(as per Commission Regulation (EU) 2019/2023):

Rated Capacity	Programme			ENERGY		Max Temperature (°C)	Max Speed (RPM)	 Residual Moisture (%)
		(kg)	(HH:MM)	(kWh/cycle)	(L/cycle)			
8 kg (1400r)	ECO 40-60	8	3:38	0.600	59.0	30	1330	53.0
	ECO 40-60	4	2:48	0.305	38.0	27	1330	52.0
	ECO 40-60	2	2:38	0.195	28.0	25	1330	56.0
	ECO 40-60+dry	5	7:30	3.150	74.0	25	1330	0
	ECO 40-60+dry	2.5	5:30	1.920	44.0	25	1330	0
	20 °C Cold Wash	8	1:23	0.320	75.0	20	1000	65.0
	Cotton 60 °C	8	1:59	1.800	75.0	57	1400	55.0
	Synthetics 40 °C	4	1:45	0.800	55.0	40	1200	37.0
	Rapid'30 °C	1	0:14	0.350	38.0	30	1000	65.0

The values given for programmes other than the ECO 40-60 programme and the wash and dry cycle are indicative only.

8.1 Power supply

Connect the washing machine to a power supply (220V to 240V~/50Hz; Fig. 8-1). Please also refer to section INSTALLATION (see P10).

8.2 Water connection

- ▶ Before connecting check the cleanliness and clarity of the water inlet.
- ▶ Turn on the tap (Fig.8-2).

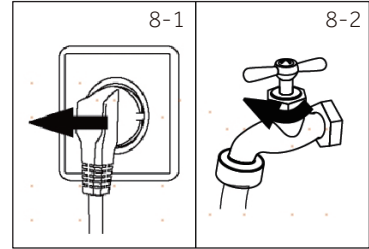

Note: Tightness

Before using, check for leakage in the joints between the tap and the inlet hose by turning on the tap.

8.3 Preparing laundry

- ▶ Sort out clothes according to fabric (cotton, synthetics, wool or silk etc.) and how dirty they are (Fig.8-3). Pay attention to the care labelling of washing labels.
- ▶ Separate white clothes from coloured ones. Wash coloured textiles first by hand to check if they fade or run.
- ▶ Empty pockets (keys, coins, etc.) and remove harder decorative objects (e.g. brooches).
- ▶ Garments without hems, delicates and finely woven textile such as fine curtains are to be put into a wash bag to care for this delicate laundry (hand or dry cleaning would be better).
- ▶ Close zippers, velco fastener and hooks, make sure the buttons are sewn on tightly.
- ▶ Place sensitive items like laundry without firm hem, delicate underwear (Dessous) and small items such as socks, belts, bras, etc. in a wash bag.
- ▶ Unfold large pieces of fabric such as bed sheets, bedspreads etc.
- ▶ Turn jeans and printed, decorated or color intensive textiles inside out; wash separately as much as possible.

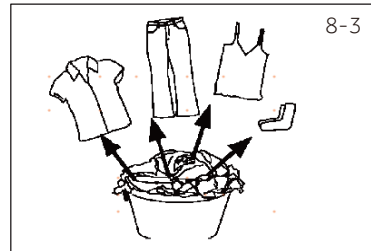

CAUTION!

Non-textile, as well as small, loose or sharp-edged items may cause malfunctions and damage of clothes and appliance.

Care chart

Washing					
	Washable up to 95°C normal process		Washable up to 60°C normal process		Washable up to 60°C mild process
	Washable up to 40°C normal process		Washable up to 40°C mild process		Washable up to 40°C very mild process
	Washable up to 30°C normal process		Washable up to 30°C mild process		Washable up to 30°C very mild process
	Wash by hand max. 40°C		Do not wash		
Bleaching					
	Any bleaching allowed		Only oxygen/ non-chlorine		Do not bleach
Drying					
	Tumble drying possible normal temperature		Tumble drying possible lower temperature		Do not tumble dry
	Line drying		Flat drying		
Ironing					
	Iron at a maximum temperature up to 200°C		Iron at a medial temperature up to 150°C		Iron at a low temperature up to 110°C; without steam (steam ironing may cause irreversible damage)
	Do not iron				
Professional Textile Care					
	Dry cleaning in tetra-chloroethene		Dry cleaning in hydrocarbons		Do not dry clean
	Professional wet clean		Do not professional wet clean		

8.4 Loading the appliance

- ▶ Put in the laundry piece by piece.
- ▶ Don't overload. Note the different maximum load according to programmes! Rule of thumb for maximum load: Keep six inches between load and drum top.
- ▶ Close the door carefully. Make sure that no pieces of laundry are pinched.

Note: Auto Weight

The display default time may vary depending on the load weight, involving the "ECO 40-60, Whites, Smart wash, Jeans, Synthetics, Hand wash, Hygiene Plus59', Cotton and Delicate".

8.5 Selecting detergent

- ▶ Washing efficiency and performance is determined by used detergent quality.
- ▶ Use only machine wash approved detergent.
- ▶ If needed use specific detergents, e.g for synthetic and woolen fabric.
- ▶ Do not use dry cleaning agents such as trichloroethylene and similar products.

Choose the best detergent

Programme	Kind of detergent				
	Universal	Colour	Delicate	Special	Softener
SPECIAL 39'	√	√	-	-	√
FRESH VAPOR	-	-	-	-	-
RAPID	√	√	-	-	√
HYGIENE PLUS 59'	√	√	-	-	√
DELICATE	-	-	√	√	√
RINSE	-	-	-	-	√
COTTON	√	√	-	-	√
ECO 40-60	√	√	-	-	√
HIGH HEAT	-	-	-	-	-
SYNTHETICS	√	√	-	-	√
DRAIN&SPIN	-	-	-	-	-
DRUM CLEAN	-	-	-	√	-

√ =Suggest Using

-=Not Recommended

O =Not Available

If using liquid detergent, it is not recommended to activate the time delay.

We recommend by using:

- ▶ Laundry powder: 20°C to 90°C* (best use: 40-60°C)
- ▶ Color detergent: 20°C to 60°C (best use: 30-60°C)
- ▶ Wool/delicate detergent: 20°C to 30°C (best use: 20-30°C)

- * Choose 90 °C wash temperature only for special hygienic requirements.
- * If you choose the water temperature 60°C or above, we would like to advise you touse less detergent.
- * It is better to use less or free detergent powder.
- * Suggested detergent type on remote control depends on the program choosen on APP.

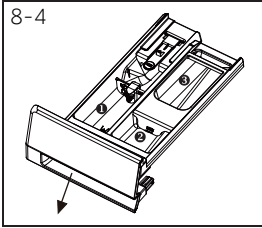

8.6 Adding detergent

1. Slide out the detergent drawer.
2. Put the required chemicals into corresponding compartments (Fig. 8-4).
3. Push back the drawer gently.



Note:

- ▶ Remove detergent residues before next wash cycle from the detergent drawer.
- ▶ Do not overuse detergent or softener.
- ▶ Please follow the instruction on the detergent package.
- ▶ Always fill the detergent just before the beginning of the wash cycle.
- ▶ Concentrated liquid detergent should be diluted before adding.
- ▶ Do not use liquid detergent if function "Delay" is selected.
- ▶ Carefully choose the programme settings according to the care symbols on all laundry labels and according to the programme table.

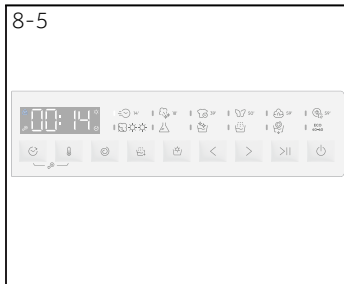

8.7 Select a programme

To get the best washing results, select a programme which fits the degree of dirty and laundry type.

Press the left and right buttons (Figure 8-5) to select the right programme. The display will show the selected programme name.



Note: Odour removal

Before first use we recommend to run the programme "Drum Clean" to remove possible corruptive residues. Please don't put any detergent or special machine cleaner in washing detergent compartment (2).



8.8 Add individual selections

Select required options and settings (Fig. 8-6); refer to Control Panel.

8.9 Start wash programme

Touch "Start/Pause" button (Fig.8-7) to start.

Appliance operates according to present settings.

Changes are only possible by cancelling the programme.

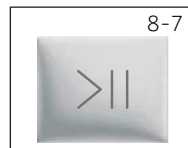

8.10 Interrupt / cancel wash programme

To interrupt a running programme, press "Start/Pause", the LED above the button is flashing. Press it again to resume operation.

To cancel a running programme and all its individual settings:

1. Touch "Start/Pause" button to interrupt the running programme.
2. Turn the knob to the programme DRAIN & SPIN and select "🔌" to drain the water.
3. After closing the programme to restart the appliance, select a new programme and start it.

8.11 After washing



Note: Door lock

- ▶ For safety reasons the door is locked partially during the washing cycle. It is only possible to open the door at the end of the programme or after the programme was cancelled correctly (see description above).
- ▶ In case of high water level, high water temperature and during spinning, it is not possible to open the door; Lock is displayed.

1. At programme cycle "End" is displayed.
2. The appliance switches off automatically.
3. Take it out carefully to prevent more wrinkling.
4. Turn off the water supply.
5. Unplug the power cord.
6. Open the door to prevent formation of moisture and odours. Let it open while not used.



Note: Standby-mode / energy-saving mode

The switches on appliance will go into standby-mode if it will not be activated within 2 minutes before starting the programme or at the end of programme. The display switches off. This save energy.

8.12 Activate or deactivate the buzzer

The acoustic signal can be deselected if necessary:

1. In standby-mode, under any program, press the "Speed+ "Extra Rinse" buttons at the same time for 5S, the buzzer will be activated, the screen shows "🔊". Press the two button simultaneously again for 5S, the screen shows "🔇".

9.1 Cleaning the detergent drawer

Take care and check there are no detergent residues. Clean the drawer regularly (Fig. 9-1) :

1. Pull out the drawer until it stops.
2. Press the release button and remove the drawer.
3. Flush the drawer with water until it is clean and insert the drawer back in the appliance.

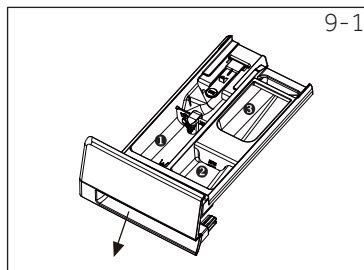

9.2 Cleaning the machine

- ▶ Unplug the machine during cleaning and maintenance.
- ▶ Use a soft cloth with soap liquid to clean the machine case (Fig.9-2) and rubber components.
- ▶ Do not use organic chemicals or corrosive solvents.



9.3 Water inlet valve and inlet valve filter

To prevent blockage of water supply by solid substances like lime clean regularly the inlet valve filter.

- ▶ Unplug the power cord and turn off the water supply.
- ▶ Unscrew the water inlet hose at the back (Fig.9-3) of the appliance as well as on the tap.
- ▶ Flush the filters with water and a brush (Fig.9-4).
- ▶ Insert the filter and install the inlet hose.
- ▶ Turn on the tap to see if it leaks.

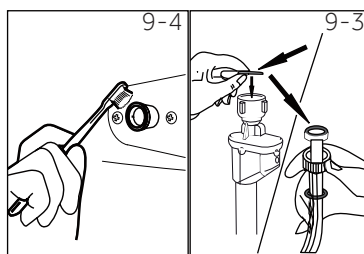

9.4 Cleaning the drum

- ▶ Remove accidental washed items, especially metal parts such as pins, coins, etc. from the drum (Fig.9-5) because they cause rust stains and damage.
- ▶ Use a non-chloride cleaner for removing rust stains. Observe the warnings on the cleaning agent manufacturer.
- ▶ Do not use any hard objects or steel wool for cleaning.

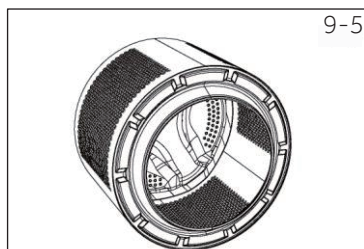

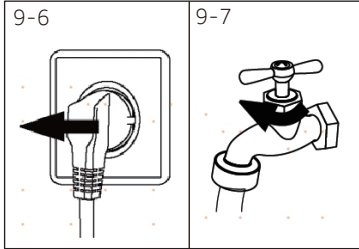

9.5 Long periods of disuse

If the appliance is left idle for a longer period:

1. Pull out the electrical plug (Fig. 9-6).
 2. Turn off water supply (Fig. 9-7).
 3. Open the door to prevent formation of moisture and odours. Leave the door open when not in use.
- Before the next usage, carefully check the power cord, water inlet and drain hose carefully. Make sure that everything is properly installed and without leakage.

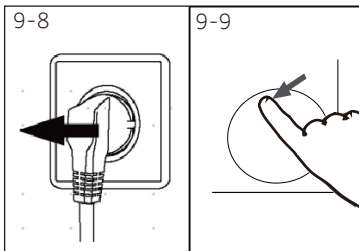

9.6 Pump filter

Clean the filter once a month and check the pump filter for instance if the appliance:

- ▶ Doesn't drain water.
- ▶ Doesn't spin.
- ▶ Creates unusual noise while running.



WARNING!

Scalding Risk! Water in the pump filter can be very hot! Before any action please ensure water has cooled down.

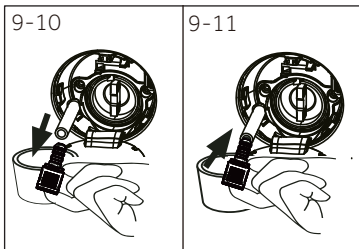

1. Turn off and unplug the machine (Fig.9-8).
2. Push and open the filter door(Fig.9-9).
3. Provide a flat container to catch the overflowing water (Fig.9-10). There could be big amounts.
4. Pull the drainhose out and hold its end above the container(Fig.9-10).
5. Taking the sealing plug out of the drainhose. (Fig.9-10).

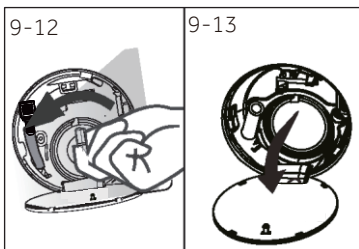

6. After completing drainage, close the drainhose and push it back to the machine(Fig.9-11).
7. Unscrew and remove counter clockwise to the pump filter (Fig.9-12).
8. Remove contaminants and dirt(Fig.9-13).

9. Clean carefully pump filter, e.g. using running water (Fig. 9-14).
10. Refix it thoroughly (Fig. 9-15).
11. Close the filter door.

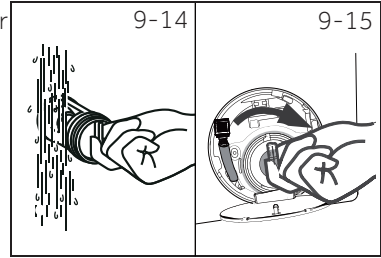

CAUTION!

- ▶ Pump filter sealing has to be clean and undamaged. If the lid is not fully tightened, water can escape.
- ▶ The filter must be in place, or it may lead to leakage.

Many occurring problems could be solved by yourself without specific expertise. In case of a problem please check all shown possibilities and follow below Instructions before you contact an after sales service. See CUSTOMER SERVICE.



WARNING!

- ▶ Before maintenance, deactivate the appliance and disconnect the mains plug from the mains socket.
- ▶ Electrical equipment should be serviced only by qualified electrical experts, because improper repairs can cause considerable consequential damages.
- ▶ A damaged power cable should only be replaced by the manufacturer, its service agent or similarly qualified persons in order to avoid a hazard.

10.1 Information codes

Following codes are displayed only for information referring to the washing cycle. No measures must be performed.

Code	Message
1:25	The remaining wash cycle time will be 1 hour and 25 minutes.
6:30	The remaining delay time will be 6 hours and 30 minutes.
cLoT	Function child lock is activated.
End	The washing cycle is finished. The appliance shuts off automatically.
LoCt	Door is closed because of high water level, high water temperature or spinning cycle.
nd	Model has not been selected.

10.2 Troubleshooting with display code

Problem	Cause	Solution
CLR FLTR	• Drainage error, water is not fully drained within 6 minutes.	• Clean pump filter • Check drain hose installation.
E2	• Lock error.	• Shut the door properly.
E4	• Water level not reached, drain hose is self-siphoning.	• Make sure that tap is fully opened and water pressure is normal. • Check the inlet hose installation.
E8	• Water protective level error.	• Contact the After sales service.
F9	• Logic: The communication between the drying temperature sensor is abnormal • Cause: Drying temp sensor failure	• Check whether the wire and terminal are well connected. • Check the resistance of dry temperature sensor.
E9	• The load is attached to the cylinder wall.	• Open the door, shake off the load cloth and put it back into the inner cylinder to start the machine.
E5	• Drainage error. Water is not fully drained within 1 minutes.	• Clean pump filter. • Check drain hose installation.
Fd	• Dry heating communication error.	• Contact the after sales service.
Fb	• Water overflowed abnormally.	• Contact the after sales service.

Problem	Cause	Solution
F3	<ul style="list-style-type: none"> • Temperature sensor error. 	<ul style="list-style-type: none"> • Contact the After sales service.
F4	<ul style="list-style-type: none"> • Heating error. 	<ul style="list-style-type: none"> • Contact the After sales service.
F7	<ul style="list-style-type: none"> • Motor error. 	<ul style="list-style-type: none"> • Contact the After sales service.
FA	<ul style="list-style-type: none"> • Water level sensor error. 	<ul style="list-style-type: none"> • Contact the After sales service.
FC0,FC1 or FC2	<ul style="list-style-type: none"> • Abnormal communication error. 	<ul style="list-style-type: none"> • Contact the After sales service.
Eb	<ul style="list-style-type: none"> • Clothes jamming alarm. 	<ul style="list-style-type: none"> • Pause operating, open the door and place garments again before restarting.

10.3 Troubleshooting without display code

Problem	Cause	Solution
Washing machine fails to operate.	<ul style="list-style-type: none"> • Programme is not yet started. • Door is not properly closed. • Machine has not been switched on. • Power failure. • Child lock is activated. 	<ul style="list-style-type: none"> • Check programme and start it. • Close the door properly. • Switch the machine on. • Check power supply. • Deactivate child lock.
Washing machine will not be filled with water.	<ul style="list-style-type: none"> • No water. • Inlet hose is kinked. • Inlet hose filter is blocked. • Water pressure is less than 0.03 MPa. • Door is not properly closed. • Water supply failure. 	<ul style="list-style-type: none"> • Check water tap. • Check inlet hose. • Unblock inlet hose filter. • Check water pressure. • Close the door properly. • Ensure the water supply.
Machine is draining while being filled.	<ul style="list-style-type: none"> • Height of drain hose is below 80 cm. • Drain hose end could reach into water. 	<ul style="list-style-type: none"> • Make sure that drain hose is properly installed. • Make sure the drain hose is not in water.
Drainage failure.	<ul style="list-style-type: none"> • Drain hose is blocked. • Pump filter is blocked. • Drain hose end is higher than 100 cm above floor level. 	<ul style="list-style-type: none"> • Unblock drain hose. • Clean pump filter. • Make sure that drain hose is properly installed.
Strong vibration while spinning.	<ul style="list-style-type: none"> • Not all transportation bolts have been removed. • Appliance has no solid position. • Machine load is not correct. 	<ul style="list-style-type: none"> • Remove all transportation bolts. • Ensure solid ground and a levelled position. • Check load weight and balance.
Operation stops before completing wash cycle.	<ul style="list-style-type: none"> • Water or electric failure. 	<ul style="list-style-type: none"> • Check power and water supply.
Operation stops for a period of time.	<ul style="list-style-type: none"> • Appliance displays error code. • Problem due to load pattern. • Programme performs soaking cycle. 	<ul style="list-style-type: none"> • Consider display codes. • Reduce or adjust load. • Cancel programme and restart.

Problem	Cause	Solution
Excessive foam floats drum and/or detergent drawer.	<ul style="list-style-type: none"> • Detergent is not appropriate. • Excessive use of detergent. 	<ul style="list-style-type: none"> • Check detergent recommendations. • Reduce amount of detergent.
Automatic adjustment of washing time.	<ul style="list-style-type: none"> • Washing programme duration will be adjusted. 	<ul style="list-style-type: none"> • This is normal and doesn't affect functionality.
Spinning fails.	<ul style="list-style-type: none"> • Unbalance of laundry. 	<ul style="list-style-type: none"> • Check machine load and laundry and run a spinning programme again.
Unsatisfactory washing result.	<ul style="list-style-type: none"> • Degree of pollution does not agree with selected programme • Detergent quantity was not sufficient. • Maximum load has been exceeded. • Laundry was unevenly distributed in the drum. 	<ul style="list-style-type: none"> • Select an other programme. • Choose the detergent acc. to the degree of pollution and according to manufacture • Reduce loading. • Loose the laundry.
Washing powder residues are on the laundry.	<ul style="list-style-type: none"> • Insoluble particles of detergent can remain as white spots on the laundry. 	<ul style="list-style-type: none"> • Perform extra rinse. • Try to brush the points from the dry laundry. • Choose an other detergent.
Laundry has grey patches.	<ul style="list-style-type: none"> • Caused by fats such as oils, creams or ointments. 	<ul style="list-style-type: none"> • Pretreat the laundry with a special cleaner.

Note: Foam formation

If too much foam is inspected during spin cycle, motor stops and drain pump will be activated for 90 seconds. If that elimination of foam fails up to 3 times, programme ends without spinning.

Should the error messages reappear even after the taken measures, switch off the appliance, disconnect the power supply and contact the customer service.

10.4 In case of power failure

The current programme and its setting will be saved. When power supply is restored, operation will be resumed.

If a power failure cuts an operating wash programme, door opening is mechanically blocked. To get out any laundry water level should not be seen in the glassy porthole of the door. - Danger of burns! Water level has to be lowered as described in "Pump filter". Not till then pull lever (A) beneath filter door (Fig. 10-1) until door is unlocked by a gentle click. Afterwards refix all parts.

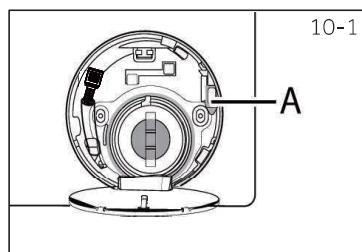

10-1

 When the washing machine in a safe state (under the water level below the window along a certain distance, barrel temperature below 55°C, the inner barrel did not turn), may unlock the doors of the machine operation.

11.1 Additional technical data

	EWY 485SW6-S / EWY 485SG6-S / EWY 485SB8-S
Voltage in V	220V-240 V~/50Hz
Current in A	10
Max power in W	1950
Water pressure in MPa	$0.03 \leq P \leq 1$
Net weight in kg	61
Washing max kg	8
Drying max kg	5

11.2 Product dimensions

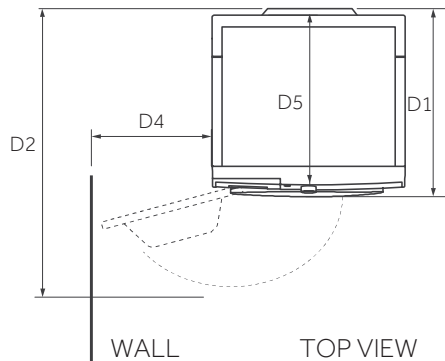
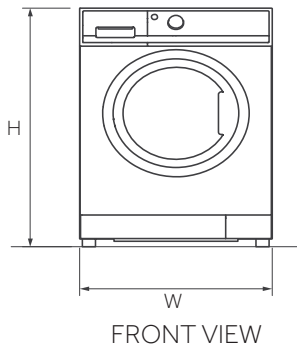

PRODUCT DIMENSIONS	EWY 485SW6-S / EWY 485SG6-S / EWY 485SB8-S
H Overall height of product mm	850
W Overall width of product mm	595
D5 overall depth of product (To main control board size) mm	495
D1 Overall depth of product mm	533
D2 Depth of door open mm	1016
D4 Minimum door clearance to adjacent wall mm	340

i Note:

The exact height of your washer is dependent on how far the feet are extended from the base of the machine. The space where you install your washer needs to be at least 40mm wider and 20mm deeper than its dimensions.

11.3 Standards and Directives **CE**

This product meets the requirements of applicable EC directives with the corresponding harmonised standards, which provide for CE marking.

We recommend our Candy Customer Service and the use of original spare parts. If you have a problem with your appliance, please first check section 10-Troubleshooting.

If you cannot find a solution there, please contact:

- ▶ your local dealer.
- ▶ the Assistance Area on the Candy website where you can find information on Warranties, Accessories and Spare Parts and Contact numbers.

To contact our Service, ensure that you have the following data available.

Each product is identified by a unique code, also called the "serial number", printed on a sticker. This can be found inside the door opening.

Model _____ Serial No. _____

Also check the Warranty Card supplied with the product in case of warranty.

It is always recommended to use original spare parts, that are available at our Authorised Customer Service Centres.

Warranty

The product is guaranteed under the terms and conditions stated on the certificate included with the product. The certificate has to be stored so as to be shown to the Authorized Customer Service Centre in case of need. You can also check the warranty conditions on our web site. To obtain assistance, please fill in the form online or contact us at the number indicated on the support page of our website.

The standard manufacturer warranty covers faults caused by electrical or mechanical faults in the product due to an act or omission of the manufacturer. If a fault is found to be caused by factors outside the product supplied, misuse or as a result of the instructions on use not being followed, a charge may be applied.

The manufacturer declines all responsibility for any printing errors in the booklet included with this product. Moreover, it also reserves the right to make any changes deemed useful to its products without changing their essential characteristics.

