

Canon



Color Bubble Jet™ Printer

S630

Quick Start Guide

Canon

S630

Getting Help From Canon

Help Us Help You Better

Before you contact Canon, please record the following information.

Serial Number (located on the inside of the printer): _____

Model Number (located on the front of the printer): _____

Printer Driver CD-ROM number (located on the CD-ROM): _____

Purchase Date: _____

Customer Technical Support*

Internet

For electronic technical support, the latest driver downloads and answers to frequently asked questions (www.usa.canon.com/consumer)

Automated Tech Support

24-hour, 7-day-a-week automated support for troubleshooting issues on most current products (**1-800-423-2366**)

Live Tech Support

To speak with a technician regarding your product, please see the “Troubleshooting” section in this Quick Start Guide for details.

Facsimile

24-hour, Fax-On-Demand System for product specifications and technical information (**1-800-526-4345**)

Extended Warranty

For information about extending your Canon service and support up to an additional two years, call **1-800-385-2155**, or visit our Web site at www.usa.canon.com/consumer (within 90 days from the date you purchased your Canon peripheral).

*Support program specifics are subject to change without notice.



S630TM

Color Bubble JetTM Printer

Quick Start Guide

Canon S630 Color Bubble Jet Printer Quick Start Guide.

Copyright

This manual is copyrighted by Canon U.S.A., Inc. with all rights reserved. Under the copyright laws, this manual may not be reproduced in any form, in whole or in part, without the prior written consent of Canon U.S.A., Inc.

© 2001 Canon U.S.A., Inc.

Disclaimer

Canon U.S.A., Inc. has reviewed this manual thoroughly in order that it will be an easy to use guide to your Canon S630 Color Bubble Jet Printer. All statements, technical information and recommendations in this manual and in any guides or related documents are believed reliable, but the accuracy and completeness thereof are not guaranteed or warranted, and they are not intended to be, nor should they be understood to be, representation or warranties concerning the products described.

Specifications are subject to change without notice.

All print speeds based on high-speed draft mode. Print speed will vary depending on system configuration, software, document complexity, print mode and page coverage.

 As an ENERGY STAR partner, Canon U.S.A., Inc., has determined that this product meets the ENERGY STAR guidelines for energy efficiency.

All information regarding non-Canon products was compiled from publicly available information. No representation is made regarding the accuracy thereof.

Trademarks

Canon and BJ are registered trademarks and Bubble Jet and S630 are trademarks of Canon Inc.

Canon U.S.A., Inc.
Digital Home and Personal Systems Division
2995 Redhill Avenue
Costa Mesa, CA 92626

Printed in the U.S.A.

Part number 7077A001AA

Contents

Chapter 1: Basic Printing

Turning Your Printer On and Off	1
What Is a Printer Driver?	2
Selecting the S630 Printer for Use	2
Recommended Paper Use	3
Loading Paper and Other Media	4
Cancelling a Print Job	7

Chapter 2: Advanced Print Features

Improving Printed Images	9
Adjusting Print Quality	9
Adjusting Color Balance, Intensity and Brightness	12
Changing the Page Setup	14
Saving and Recalling Driver Settings	17

Chapter 3: Printing Maintenance

Monitoring Ink Levels	19
Replacing Ink Tanks	20
Printing a Nozzle Check Pattern	20
Cleaning the Printhead	22
Aligning the Printhead	23

Chapter 4: Troubleshooting

Tips for Troubleshooting	25
Customer Care Center	32

Chapter 5: The BJ Solution Software—Downloading Images

Minimum System Requirements	34
Installing the BJ Solution Software	34
Accessing the Online Manual	35
Windows Users: Using Your Software	36
Windows Users: Uninstalling the BJ Solution Software	38
Mac OS Users: Using Your Software	38
Mac OS Users: Uninstalling the BJ Solution Software	40

Appendix

Installing the Printer Driver	41
Uninstalling the Printer Driver	43
Registering Your Canon Product	43
Safety Information	44
Regulatory Information	46
Product Specifications	47
Limited Warranty—U.S. Only	48

Index	51
-------------	----

Chapter 1: Basic Printing

Congratulations on purchasing your new Canon® S630 Color Bubble Jet™ Printer! With this printer, you can print basic business documents in color or black and white, as well as print on a variety of specialty media, such as Canon High Resolution Paper (ideal for business documents such as presentations that include large numbers of color illustrations), Canon Glossy Photo Paper or Canon Photo Paper Pro (for digital photographs) and Canon Transparencies (for presentations). For a full list of the Canon specialty media that can be used with your S630 printer, see “Specialty Media” on page 3.



Note

This quick start guide describes some of the features of your S630 printer and how to use them. For more information, view and/or print the *S630 User's Guide* on the Setup Software & User's Guide CD-ROM.

Driver features and screen shots described in this guide reflect Windows® 98 and may be different for Windows NT® 4.0 and Windows 2000 users.

Turning Your Printer On and Off

To turn your printer on or off, press the **POWER** button.

The **POWER** lamp will flash green when warming up or when a print job is being sent to the printer. It will glow a steady (non-flashing) green when the printer is ready for use or when the print job is complete.



Note

If the **POWER** lamp flashes orange, see “Handling Error Messages” on page 30.

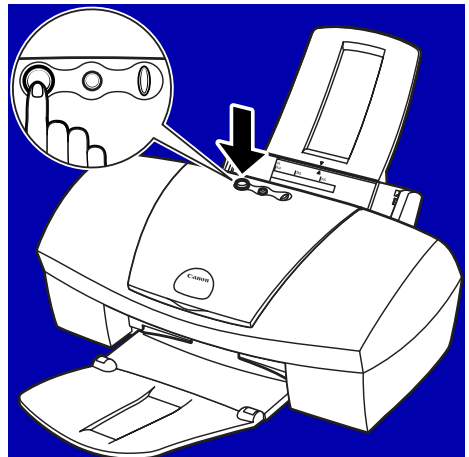

What Is a Printer Driver?

Most computers require special software to link the software applications you use to create documents or images with your printer. This software, called a *printer driver*, converts information from the application into a format that the printer can understand. The Canon S630 printer driver also provides other features such as monitoring the printer's paper supply and ink levels.

Selecting the S630 Printer for Use

If the S630 is the only printer connected to your computer, it will automatically be set as the default (main) printer. If you switch to another printer temporarily, remember to reset the S630 as your default printer.



To set the S630 as the default printer in Windows®:

1. Click **Start**, then **Settings**, then **Printers**.
2. Right-click the **Canon S630** printer icon, then click **Set as Default**. The Canon S630 printer icon will display a check mark indicating it is the default printer.



To select the S630 from within a Windows application:

Even if another printer is set as the default printer, you can still select the Canon S630 for a specific print job from within most Windows applications.



Menus vary between applications. Consult your application user documentation if the Print option is not listed.

1. From the **File** menu, click **Print**.
2. Select **Canon S630** from the Name drop-down list, then click **OK**.



To select the S630 in Mac® OS:

1. Click **Apple**, then **Chooser**.
2. Click the **S630** printer icon. The S630 will remain the default printer until another is selected.

Recommended Paper Use

Two steps are recommended for getting the best output for your printed documents:

- Set the printer thickness lever for the media used. (See “Load Limit and Paper Thickness Lever Position” on page 4.)
- Select the correct media setting in the printer driver. (See “Chapter 2: Advanced Print Features” on page 9.)

General Business Printing

For everyday paper printing, use plain paper (17 to 28 lb.). Use standard #10 envelopes with your S630 printer.

Specialty Media

For optimum results, Canon recommends that you use genuine Canon media with your S630 printer. Follow the instructions that come with any specialty media on storing, handling and printing.

The specialty media available for use with the S630 include:

- Canon High Resolution Paper
- Canon Transparencies
- Canon Banner Paper
- Canon Glossy Photo Paper
- Canon Photo Paper Pro
- Canon Glossy Photo Cards
- Canon High Gloss Photo Film
- Canon Magnet Sheets
- Canon Greeting Cards
- Canon T-Shirt Transfers

**Note**

For instructions on loading and handling specialty media, see the instructions that come with that media type or see the *S630 User's Guide* on the Setup Software & User's Guide CD-ROM.

Handle media carefully by its edges. Dirt or fingerprints on the print surface will adversely affect print quality.













Media to Avoid

Do not use the following types of media with your S630 as they could produce poor quality print images, or jam or damage the printer:

- Paper that is folded, excessively curled, wrinkled or wrapped
- Damp paper
- Excessively thin or thick paper
- Paper with pasted photos, stickers, etc.
- Envelopes with overlapping flaps or self-sealing flaps
- Tractor feed paper, perforated paper or 3-hole punched paper, or paper with any type of attached fasteners, ribbons, etc.

Loading Paper and Other Media

Load Limit and Paper Thickness Lever Position

Media Type	Paper Rest Load Limit	Paper Thickness Lever Position
Plain paper	up to 100 sheets (17 lb.)	Left 
High Resolution Paper	up to 80 sheets	Left 
Photo Paper Pro	1 sheet	Left 
Photo Paper Pro (4 x 6)	up to 20 sheets	Left 
High Gloss Photo Film	1 sheet	Left 
Glossy Photo Paper	up to 10 sheets	Left 
Glossy Photo Cards	up to 20 sheets	Left 
Transparencies	up to 30 sheets	Left 
Magnet Sheets	1 sheet	Left 
Greeting Cards	1 sheet	Left 
#10 Envelopes	up to 10 envelopes	Right 
Banner Paper	1 sheet (can print up to 6 connected sheets)	Right 
T-Shirt Transfers	1 sheet	Right 

The S630 can print on paper ranging from standard copier paper (usually 17–28 lb.) to specialty media paper and envelopes.

The paper thickness lever is located inside the front cover, on the printhead holder. It controls the paper feed for the type and weight of the media on which you are printing.

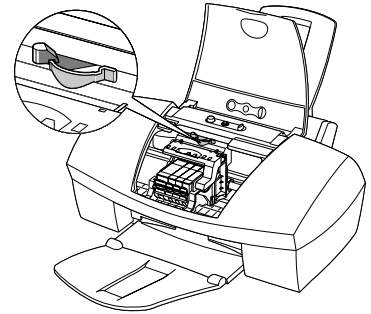

 For envelopes (see “To load envelopes:” on page 6), banners and T-Shirt Transfers.

 For regular paper and other media with a left position in the table (see “Load Limit and Paper Thickness Lever Position” on page 4).

Use the chart on the previous page to ensure that the paper thickness lever is set correctly for the type of media you are using.

To load paper or other media:

1. Make sure the paper thickness lever is set correctly for the media used.
2. Slide the paper guide completely to the left.
3. Fan the edges of the sheets to remove static cling and avoid paper jams, then tap the edges of the stack against a flat surface so the stack is aligned.
4. Insert the media into the paper rest, with the print side facing up.

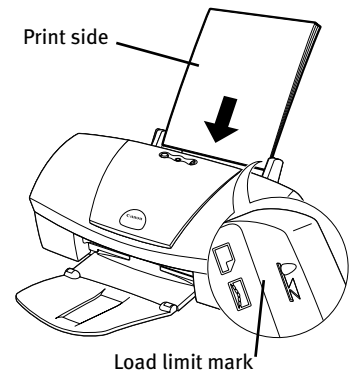

Note

Some papers, especially specialty media, have specific sides for printing. The print side is usually the glossier side or the brighter white side.

When using specialty media, do not touch the print side.

5. Slide the paper guide to the edge of the media until it is firmly in place.

Note

You can load up to 100 sheets of plain (17 lb.) paper or 80 sheets of Canon High Resolution Paper in the paper rest at one time. Never load the paper above the load limit mark.

To load envelopes:

1. Lift the cover and set the paper thickness lever to the envelope mark. Close the cover.
2. Slide the paper feed guide to the left.
3. Press down on the corners and sides of the envelopes to make them as flat as possible by expelling all of the air.

To avoid paper jams, make sure envelopes are flat before you load them into the paper tray.

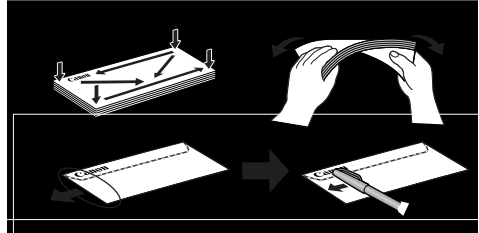

Note

Make sure that none of the flaps overlap. If the envelope edges are not flat, crease them with the side of a pen.

Do not allow more than 10 envelopes to stack on the paper output tray.

4. With the address side facing up and pointed in the direction shown in the illustration, align the stack with the right side of the paper rest, then insert the stack into the printer.
5. Slide the paper guide to the edge of the envelopes until it is firmly in place.

Flap side of envelope faces down

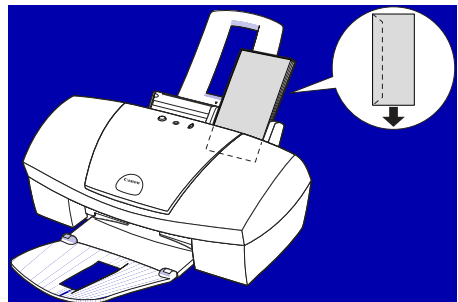

Cancelling a Print Job

There are several ways to cancel a print job in progress:

To cancel a print job from the printer:

While a job is printing, press the **Resume/Cancel** button on the printer. The print job will be cancelled and the paper ejected.

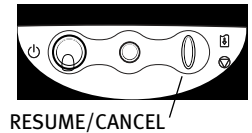

To cancel a print job from the S630 print dialog box:

When a job is printing on the S630, a print status dialog box displays on your screen.

Click **Cancel** at any time while this dialog box is open to cancel the current print job. The print job will be cancelled and the paper ejected.

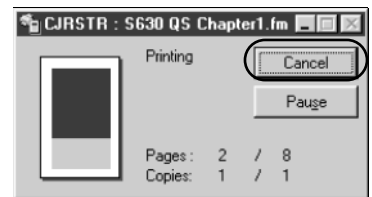

To cancel a print job from the Printer Status Monitor:

1. Click **Start**, then **Settings**, then **Printers**.
2. Right-click **Canon S630**, then click **Properties**.
3. Select the **Maintenance** tab, then click the **Start Status Monitor** button.
4. Click **Cancel Printing**.

The print job will be cancelled and the paper ejected.

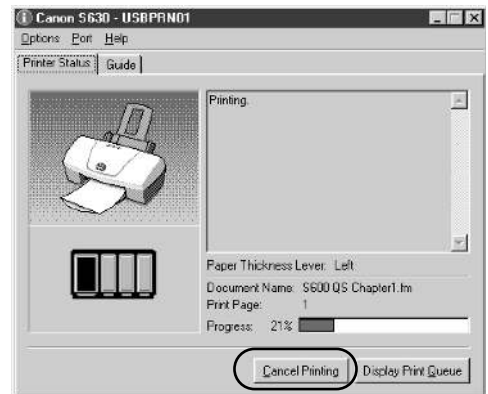

To cancel a print job from Windows:

1. Click **Start**, then **Settings**, then **Printers**.
2. Double-click **Canon S630**, click the print job, then press the **Delete** key.

The print job will be cancelled and the paper ejected.



To cancel a print job in Mac OS when using foreground printing:

On your keyboard, press the **Apple™ Command** key (**⌘**) and the **period** key (**.**) at the same time.

The print job will be cancelled and the paper ejected.



To cancel a print job in Mac OS when using background printing:

1. While a job is printing, go to the BJ Print Monitor window (click **Finder**, then **BJ Print Monitor**).
2. Highlight the job to be cancelled.
3. Click the **Stop Printing** icon in the Print Queue dialog box.

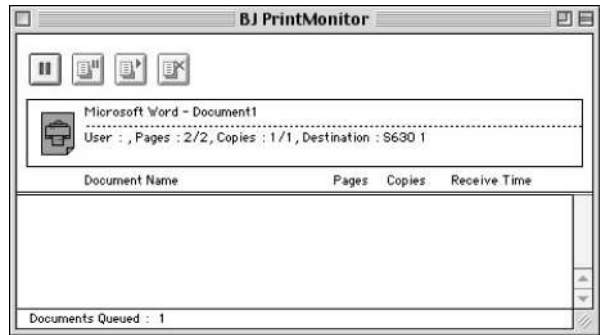

The print job will be cancelled and the paper ejected.

Chapter 2: Advanced Print Features

Improving Printed Images

Two important factors control the quality and output of your printed images:

Paper and Ink Using recommended paper or specialty media for printing graphic images or photographs can significantly improve the quality of your printout. (See “Recommended Paper Use” on page 3.) Also, always use the specific Canon inks for your S630 printer, as noted on the inside back cover.

Printer Driver Settings You can use a variety of settings to enhance the quality of the print, the colors and the way in which the document comes out of the printer.



Many of these features are covered in this chapter. For more information, see the *S630 User's Guide* on the Setup Software & User's Guide CD-ROM, or access the online help:

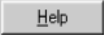

While in the Properties window, press the **F1** key, or click  in the upper right corner then click the feature you want to know more about, or click the  button when displayed.



Turn Bubble Help on by selecting **Help**, then **Show Bubble Help**.

Adjusting Print Quality

Two of the features that affect the appearance and quality of your printed documents can be controlled with the printer driver.

Media Type The S630 automatically adjusts printer settings to improve print quality based on the media type (plain paper, Glossy Photo Paper, etc.) you select.

Print Quality When you select a media type, print quality is automatically set for that media. You can change print quality settings if desired.



To manually adjust print quality settings in Windows:

1. From an application **File** menu, select **Print**.
2. With **Canon S630** as the selected printer, click **Properties**. The S630 Properties window will open to the Main tab.
3. Select the appropriate Media Type from the drop-down menu.
4. Each media type has a default print quality, but you can select a different Print Quality:

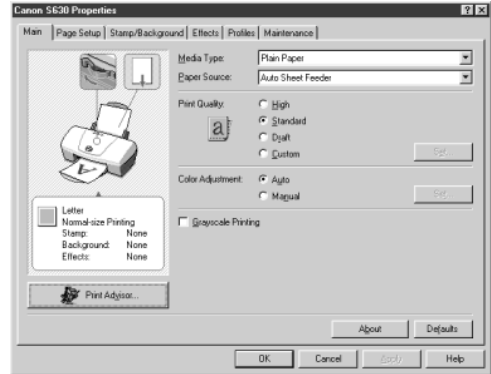

High For high quality when printing a color document.

Standard For high quality when printing text.

Draft For printing text drafts at a faster speed.

Custom Allows for more precise control.

If you select **Custom**, the Set button becomes active. Click **Set** to open the Set Print Quality dialog box. You can control two features:

Print Quality The printer driver provides five settings for custom print quality, ranging from Fast at the far left (prints at 630 dpi, which means faster printing and less ink) to Fine, which prints at 2400 x 1200 dpi.

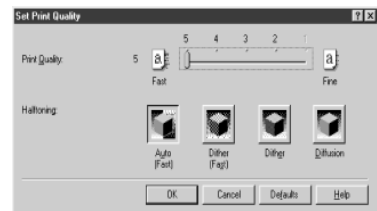

Halftoning This controls the pattern in which the ink is laid down during printing for graphic images.

5. When done, click **OK**.



To select best print quality with the Print Advisor wizard:

Print Advisor is a wizard that helps you select the most optimum media type and print quality for your print job.

1. From an application **File** menu, select **Print**.
2. With **Canon S630** as the selected printer, click **Properties**. The S630 Properties window will open to the Main tab.
3. Click the **Print Advisor** button, and the wizard dialog box will open.
4. Follow the on-screen instructions to select the optimum output type, media and settings for your print job.
5. Click **OK** to save the setting and close the S630 Properties window.

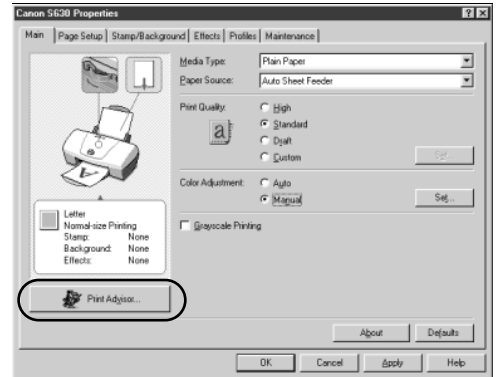

To automatically make images more smooth in Windows:

Image Optimizer smooths jagged edges formed when enlarging a photo or graphic from its original size. It is most effective when used with low-resolution images.

1. From an application **File** menu, select **Print**.
2. With **Canon S630** as the selected printer, click **Properties**.
3. Click the **Effects** tab, then click the **Image Optimizer** check box.
4. Click **OK** to save this setting and close the S630 Properties window.





To manually adjust print quality settings in Mac OS:

1. Make sure that the **S630** is the selected printer (from the **Apple** menu, select **Chooser**, then **S630**).
2. From an application **File** menu, click **Print**.
3. Click the **Manual**  print mode icon, then click the **Details** button. The Detailed Setting dialog box will open. Make sure **Quality** is selected.
4. Click and drag the **Print Quality** slide bar to select your preferred output quality.
5. When done, click **OK**, then **Print**.

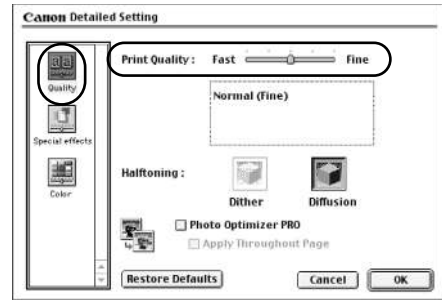
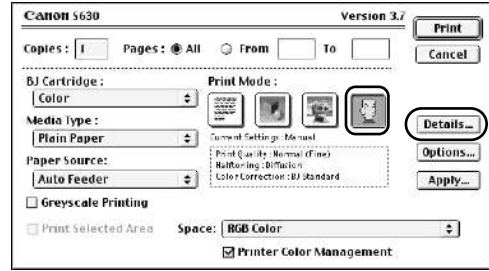

Adjusting Color Balance, Intensity and Brightness

You can enhance color printing by adjusting the color balance, intensity (saturation) and brightness.



Note

For more information on these settings, see the *S630 User's Guide* on the Setup Software & User's Guide CD-ROM, or access the online help (press **F1** or click  in Windows; turn on Bubble Help in Mac) while in the printer driver interface.



To manually adjust color settings in Windows:

1. From an application **File** menu, select **Print**.
2. With **Canon S630** as the selected printer, click **Properties**.
3. On the **Main** tab, under **Color Adjustment**, select **Manual**. The **Set** button will become active.

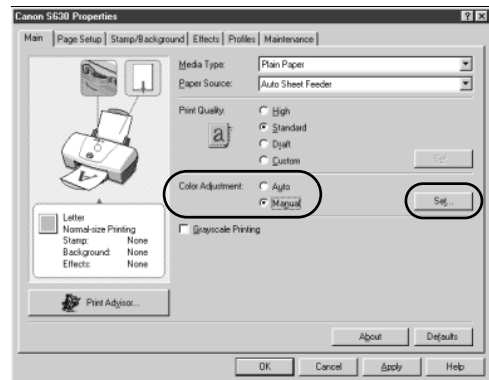

4. Click **Set**, and the **Manual Color Adjustment** dialog box will open.
5. Click and drag the **Color Balance** slide bar for each color to adjust the color settings. The results will preview.
6. Click and drag the **Intensity** slide bar to change the intensity (saturation) for the image. The results will preview.
7. Image Color Management (ICM) is a feature that automatically adjusts the image colors. (This feature is only available in Windows 98, Me and 2000.)



-  **Note** To use ICM for automatic color adjustment, click the **Enable ICM** check box. All other features on this tab (except Intensity) will become inactive.
8. Under **Print Type**, select **Photo** when printing photographs. This allows for a wider range of tones. Set to **Graphic** when printing graphic images for crisper, cleaner graphic images.
 9. Select a **Brightness** setting to determine how light or dark the image will appear when printed.
 10. When done, click **OK**.

-  **Note** To print in black only, check the **Grayscale Printing** box. This will convert color images to grayscale when printing, without changing the original colors in the document.



To automatically optimize the image in Windows:

Photo Optimizer PRO automatically adjusts a photographic image created with a digital camera. Use this feature to compensate for unsatisfactory color balance and over- or under-exposure before printing.

1. From an application **File** menu, select **Print**.
2. With **Canon S630** as the selected printer, click **Properties**.



3. Select the **Effects** tab.
4. Click to check the **Photo Optimizer PRO** check box.

When Photo Optimizer PRO is checked, the Apply Throughout Page option becomes active. If this box is left unchecked, the S630 will optimize each image individually. If checked, all images will be automatically corrected with the same settings.

5. When done, click **OK**.



To adjust color settings in Mac OS:

1. Make sure that the **S630** is the selected printer. (From the **Apple** menu, select **Chooser**, then **S630**.)
2. From an application **File** menu, click **Print**.
3. Click the **Manual**  print mode icon, then click **Details**.
4. Click the **Color** icon.
5. Adjust the **Color Correction**, **Print Type**, **Gamma Correction**, **Color Balance** and **Intensity** settings for your image.
6. When done, click **OK**, then **Print**.

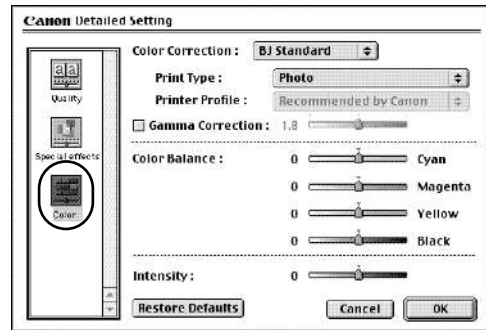

Changing the Page Setup

You can change how the image is printed without affecting the original image file.



To change page setup in Windows:

1. From an application **File** menu, select **Print**.
2. With **Canon S630** as the selected printer, click **Properties**.
3. Click the **Page Setup** tab.
4. From this tab, you can change the following options:
 - Page Size** defaults to the page size set in the original document, but can be changed.

Orientation lets you select either portrait or landscape orientation.

Printer Paper Size is the page size used by the printer. This defaults to match the page size. However, a different printer paper size can be selected if a Printing Type other than normal is selected (see below).

Printing Type defaults to Normal-size Printing. Click the drop-down arrow to select a different Printing Type:

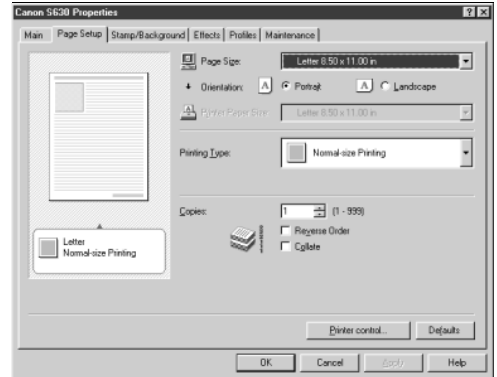

Scaled Printing With this option you can set the scale of the printed image down to 20% or up to 400% of the original.

Page Layout Printing Lets you set the number of pages to print on a single sheet. Click **Specify** to set the number of pages to a sheet of paper (2 to 16), the print order for those pages (left to right or right to left) and whether you want to print a border around each page.

Poster Printing Lets you print an oversized image on multiple pages that can then be manually joined together. Click **Specify** to set the image divisions (how many tiles the image will break up into).

Banner Printing Used for printing banners on special banner paper.

5. When done, click **OK**.

For more feature descriptions, see the *S630 User's Guide* on the Setup Software & User's Guide CD-ROM or access the online help.



To change page setup in Mac OS:

1. Make sure that **S630** is the selected printer (from the **Apple** menu, select **Chooser**, then **S630**).
2. From an application **File** menu, click **Page Setup**. The Page Setup dialog box will open.

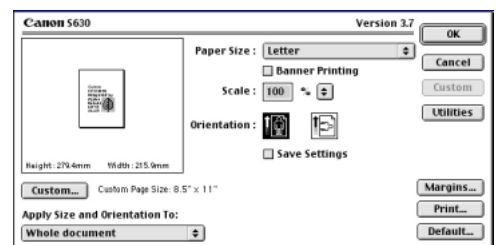

3. From this dialog box, you can change the following:
 - Select a paper size from the Paper Size drop-down list. (If printing a banner, click to check the **Banner Printing** check box, then follow the on-screen instructions.)
 - Set a Scale percentage value between 50% and 200% to print the image in a size different from the original document.
 - Click an **Orientation** icon to change the page orientation.
4. To save these settings for the next print job, click the **Save Settings** check box.
5. When done, click **Print**.



To change page layout and print order in Mac OS:

1. Make sure that **S630** is the selected printer (from the **Apple** menu, select **Chooser**, then **S630**).
2. From an application **File** menu, click **Print**. The Print window will appear.
3. Click **Options**. The Options dialog box will open.
4. From the Options dialog box, you can enter or change the following:
 - To print in reverse order, check the **Print in Reverse Order** box.
 - If you are printing more than one copy, check the **Print Collated Pages** box to collate each copy instead of printing all of page 1, then all of page 2, etc.
 - Under **Page Layout**, click the drop-down arrow to change to a 2 Up or 4 Up layout.

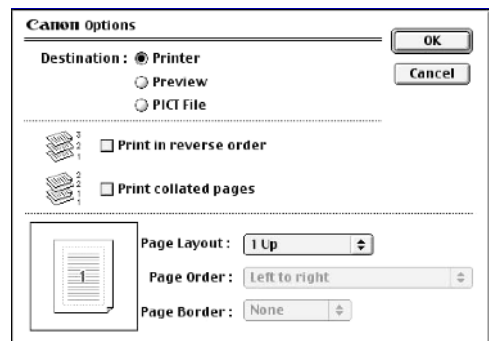
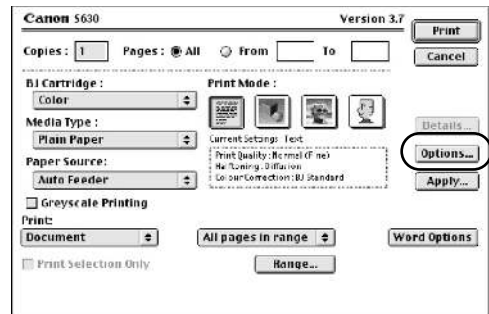

- If the page layout is other than 1 Up, you can select a different Page Order specific to the selected page layout.
 - If the page layout is other than 1 Up, you can also select whether to print a Page Border around each page.
5. When done, click **OK**, then **Print**.

**Note**

For more information on printer driver features, see the *S630 User's Guide* on the Setup Software & User's Guide CD-ROM, or use the Mac Bubble Help.

Saving and Recalling Driver Settings

When you change printer driver settings for a specific print job, such as printing black and white photos, or printing documents with a special background, you can save and name these settings for future use on other similar print jobs.



To save driver settings in Windows:

1. From an application **File** menu, select **Print**.
2. With **Canon S630** as the selected printer, click **Properties**.
3. Make the desired printer driver setting changes.
4. Without exiting the Properties window, select the **Profiles** tab.
5. Click **Add to Profiles**, then type a name for your settings in the Name field. You can also select an icon for this profile.
6. Type a description of your settings.
7. Click **Save**.

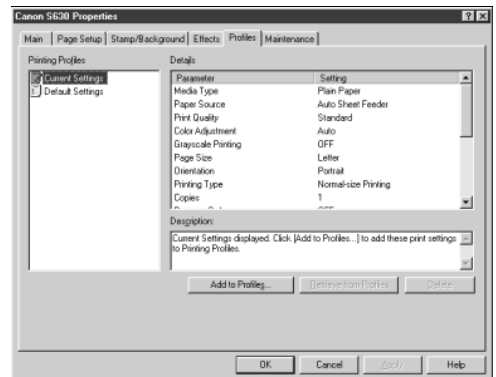

To retrieve a saved setting profile in Windows:

1. From an application **File** menu, select **Print**.
2. With **Canon S630** as the selected printer, click **Properties**.

3. Select the **Profiles** tab.
4. Highlight the saved setting profile you want to use.
5. Click **Retrieve from Profiles**, then click **OK** to confirm the profile change. The profile settings will become active.
6. Click **OK** again to close the window.

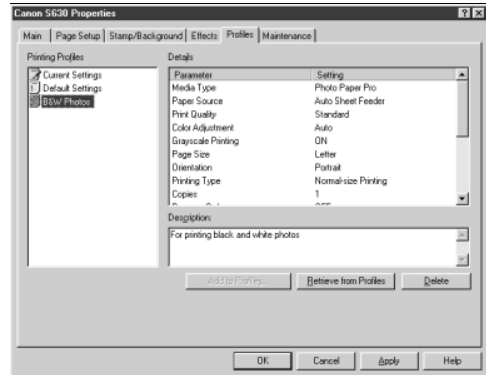

To save driver settings in Mac OS:

1. From an application **File** menu, select **Print**. The Print window will appear.
2. Make the desired printer driver setting changes.
3. From the Print window, click **Apply**. The Register Settings dialog will open.
4. Click **Apply** again, then type a name for the settings.
5. Click **OK**. The Register Settings window will reappear.

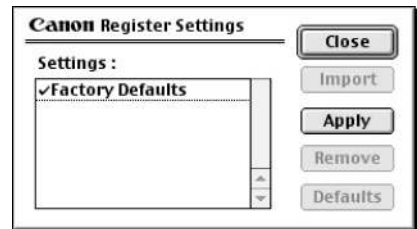

Note

To save the new settings as your default settings for the Manual icon, click the name in the Settings list, then click **Default**.

See the *S630 User's Guide* on the Setup Software & User's Guide CD-ROM for instructions on removing manual settings and restoring default settings.

6. When done, click **Close**.



To recall driver settings in Mac OS:

1. From an application **File** menu, select **Print**.
2. Click **Apply**, then select the name of your saved settings.
3. Click **Defaults**, then **OK**.
4. Click **Import**, then **Close**.

Chapter 3: Printing Maintenance

Monitoring Ink Levels

The print driver allows you to monitor the level of ink in each ink tank.



To check ink levels in Windows:

1. With the printer on, click **Start**, then **Settings**, then **Printers**.
2. Right-click the **Canon S630** icon, then select **Properties**.
3. Select the **Maintenance** tab, then click **Start Status Monitor**. The Canon S630 Status Monitor window will appear.

The Ink panel displays the ink levels for each tank.

The following icons appear when an ink tank is low or has run out of ink:

- ① **Ink low.** Replace ink tank as soon as possible.
 - ⊗ **Ink out.** Replace ink tank immediately.
4. Click  on the top right of the window to close the Status Monitor, then click **OK** to close the Properties window.



To check ink levels in Mac OS:

The S630 Print Monitor can display ink levels when they are running low if you have enabled background printing in the Choose option. See the *S630 User's*

Guide on the Setup Software and User's Guide CD-ROM for more information about this feature.

**Note**

By default, Background Printing is off.

Replacing Ink Tanks

To replace an empty ink tank:

1. With the printer on, open the front cover. The printhead holder will automatically move to the center.
2. Press the tab on the front of the empty ink tank, then remove and discard the empty tank.
3. Remove the new ink tank from its package. Pull the orange tape up, remove the wrapper and twist off the orange protective cap.

**Caution**

To avoid spilling ink, never press on the sides of an ink tank.

4. Holding the new ink tank at a slight angle, align it with the correct color slot, then gently insert it.

**Caution**

Do not force an ink tank into the printhead. If the ink tank does not go in smoothly, realign it, then try again.

5. Press down on the ink tank until it clicks into place.
6. Close the front cover.

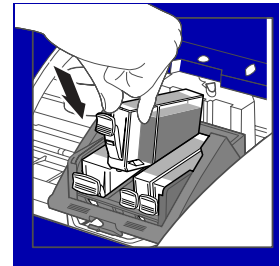
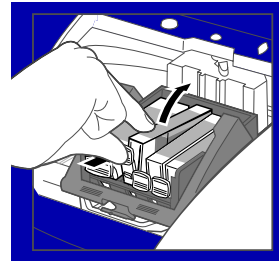

Printing a Nozzle Check Pattern

The printhead discharges ink through nozzles—tiny openings from which the ink is sprayed. If faded or streaked colors and text appear on your output when you print, some of the nozzles may be clogged. You can check for this problem by printing a nozzle check pattern.



To print a nozzle check pattern in Windows:

1. Make sure the printer is on and paper loaded.
2. Click **Start**, then **Settings**, then **Printers**.
3. Right-click the **Canon S630** printer icon and select **Properties**.
4. Click the **Maintenance** tab, then click the **Nozzle Check** button.
5. Click **OK** to start the nozzle test. The nozzle test pattern will print.



Note The Maintenance tab may vary for Windows NT 4.0 and Windows 2000.

6. Check the printed nozzle check pattern. If part of the top pattern is missing, see “Cleaning the Printhead” on page 22 for procedures.



To print a nozzle check pattern in Mac OS:

1. Make sure the printer is on and paper loaded.
2. In a software application, click **File**, then **Page Setup**.
3. Click **Utilities**. The Canon S630 Printer Utility window will appear.
4. Select **Test Print** from the drop-down menu.
5. Click the **Nozzle Check** button. When prompted, click **OK**. The nozzle test pattern will print.
6. When done, click **Close**.
7. Check the printed nozzle check pattern. If part of the top pattern is missing, see “Cleaning the Printhead” on page 22 for procedures.

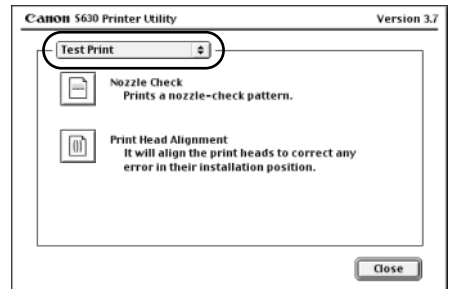

Cleaning the Printhead

If your printed output appears faded, streaked or scratchy, the printhead may need to be cleaned or aligned. See the *S630 User's Guide* on the Setup Software & User's Guide CD-ROM for additional corrective actions.



Note

Printhead cleaning consumes ink. Avoid unnecessary cleaning.



To clean the printhead in Windows:

1. With the printer on, click **Start**, then **Settings**, then **Printers**.
2. Right-click the **Canon S630** printer icon, then select **Properties**.
3. Click the **Maintenance** tab, then click the **Cleaning** button. The printer will clean the printhead.



Note

The Maintenance tab and procedures may vary for Windows NT 4.0 and Windows 2000. Follow the instructions when prompted.



4. Click **OK** to close the window.
5. After the cleaning, print a nozzle check pattern to check the results. See “Printing a Nozzle Check Pattern” on page 20.
6. If there is no change after cleaning, check the amount of ink remaining. If an ink tank is empty, replace it. See “Monitoring Ink Levels” on page 19.



To clean the printhead in Mac OS:

1. Make sure the printer is on.
2. In a software application, click **File**, then **Page Setup**.
3. Click **Utilities**. The Canon S630 Printer Utility window will appear.

4. Click the **Cleaning** button.
5. Select the colors to be cleaned, then click **OK**. The printer will clean the printhead.
6. When done, click **Close**.
7. After the cleaning, print a nozzle check pattern to check the results. See “Printing a Nozzle Check Pattern” on page 20.
8. If there is no change after cleaning, check the amount of ink remaining. If an ink tank is empty, replace it. See “Monitoring Ink Levels” on page 19.

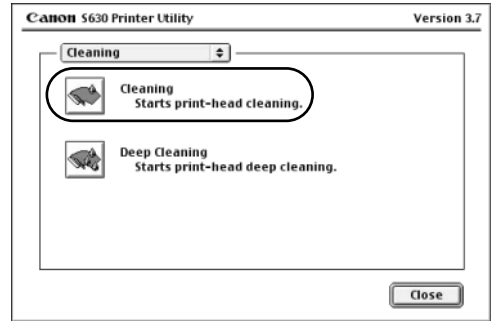

Aligning the Printhead

Sometimes printed output can be faded or unclear because the printhead needs to be aligned.



To align the printhead in Windows:

1. Make sure the printer is on and paper loaded.
2. Click **Start**, then **Settings**, then **Printers**.
3. Right-click the **Canon S630** printer icon, then select **Properties**.
4. Click the **Maintenance** tab, then click the **Print Head Alignment** button.



5. When asked to start printhead alignment, click **OK**.
6. Follow the on-screen instructions to complete printhead alignment.



Note The Maintenance tab and procedures may vary for Windows NT 4.0 and Windows 2000. Follow the instructions when prompted.

7. When printhead alignment is complete, click **OK** to close the window.



To align the printhead in Mac OS:

1. Make sure the printer is on and paper loaded.
2. From the **File** menu in a software application, click **Page Setup**.
3. Click the **Utilities** button.
4. Click the down-arrow to select **Test Print**.
5. Click the **Print Head Alignment** icon.
6. Follow the on-screen instructions to complete printhead alignment.
7. After each printhead alignment pattern check, click **Send**.
8. When printhead alignment is complete, click **Close**.

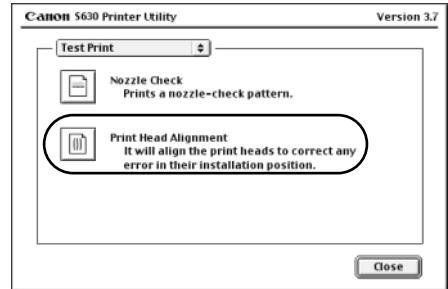

Chapter 4: Troubleshooting

Tips for Troubleshooting

Troubleshooting usually falls into one of the following categories:



Installation The printer driver will not install properly.



Printer Hardware The printer is not working or not working as expected.



Printed Output The printed output is not coming out as expected.



Error Message You are getting an error message from the software (displayed on the screen) or the printer (indicated by flashing lights).



Customer Care Center Canon offers a full range of customer technical support options.

If you encounter difficulties during installation or operation of your Canon S630 printer, quickly scan all topics until you find a description that approximates your difficulty. Go through the related solutions until you find one that works.



Troubleshooting Installation

⦿	PROBLEM	POSSIBLE CAUSE	TRY THIS
	Cannot install the printer driver	Procedure not followed correctly	See “Installing the Printer Driver” on page 41, or see the <i>S630 User’s Guide</i> on the Setup Software & User’s Guide CD-ROM for more information.



PROBLEM	POSSIBLE CAUSE	TRY THIS
Cannot install the printer driver <i>(continued)</i>	Previous or same printer driver version already installed	Always uninstall the previous version of the printer driver before installing the new version. See “Uninstalling the Printer Driver” on page 43.
	Other applications running in the background	Other open applications on your computer can interfere with the installation routine. Close all open software applications before reinstalling the printer driver. See “Installing the Printer Driver” on page 41.
Installation not starting automatically when CD is inserted into drive		<div data-bbox="553 508 602 569" style="display: inline-block; vertical-align: top;"></div> <p>WINDOWS If printer driver installation did not start automatically when you loaded the CD-ROM:</p> <ol style="list-style-type: none"> 1. Double-click My Computer on the Windows desktop, then double-click the CD-ROM drive. 2. Double-click msetup. <p>If you install the printer driver by clicking Start, then Run, specify the correct CD-ROM drive and file name (d:\msetup.exe, where d is the CD-ROM drive).</p> <div data-bbox="553 795 602 855" style="display: inline-block; vertical-align: top;"></div> <p>MAC OS Double-click the CD-ROM icon on your desktop.</p>
CD-ROM drive not specified		<p>Normally, after you insert the S630 CD-ROM, the setup window displays automatically. If it does not:</p> <div data-bbox="553 956 602 1017" style="display: inline-block; vertical-align: top;"></div> <p>WINDOWS</p> <ol style="list-style-type: none"> 1. Double-click My Computer on the Windows desktop, then double-click the CD-ROM drive. 2. Double-click msetup. <div data-bbox="553 1086 602 1147" style="display: inline-block; vertical-align: top;"></div> <p>MAC OS Double-click the CD-ROM icon on your desktop.</p>
CD-ROM drive not working properly		<div data-bbox="553 1182 602 1242" style="display: inline-block; vertical-align: top;"></div> <p>WINDOWS Use Windows Explorer to confirm that the CD-ROM is operating normally:</p> <ol style="list-style-type: none"> 1. From the Desktop, double-click My Computer, then CD-ROM. 2. If the files do not appear, refer to your Windows documentation for more information. <div data-bbox="553 1407 602 1468" style="display: inline-block; vertical-align: top;"></div> <p>MAC OS Open the Apple System Profiler, click Devices and Volumes, then open the CD-ROM.</p>

PROBLEM	POSSIBLE CAUSE	TRY THIS
Cannot install the printer driver <i>(continued)</i>	Computer cannot detect a printer port	<p>Verify that the correct cable (USB or parallel) is connected to both your printer and your computer, and that the connection is secure.</p> <p>Verify that the computer is turned on and the POWER lamp is a steady (non-flashing) green.</p> <p>If this does not handle the problem, exit the installation procedure, turn off the printer, restart the computer and reinstall the software again. The installer will prompt you when to turn the printer back on.</p> <p>Also see the <i>S630 User's Guide</i> on the Setup Software & User's Guide CD-ROM for more information.</p>



Troubleshooting Printer Hardware



PROBLEM	POSSIBLE CAUSE	TRY THIS
Paper jams in the printer	Media jammed during paper feed	<p>Gently pull the jammed paper out of the paper output tray or the paper rest, whichever is easier.</p> <p>If the paper tears and some is left in the printer, turn the printer off, open the front cover, and remove the pieces. If you cannot reach or remove the torn paper, do not attempt to disassemble the printer yourself. Contact the Customer Care Center.</p> <p>Reload paper into the paper rest, then press Resume/Cancel on the printer.</p> <p>You will need to reprint the page that jammed.</p> <p>If you turn the printer off, your print job data will be lost. Print the job again.</p> <p>Use a standard paper size whenever possible to prevent jams.</p>
Printer is not responding	Power cord not securely connected	Verify that the power cord is securely connected to the printer and plugged into a working outlet.
	Printer is not turned on, or is not ready	<p>Verify that the POWER lamp is on and glowing a steady green.</p> <p>If the light is off, press the POWER button. The green light will flash as the printer is warming up, then go to a steady (no flash) state when the printer is ready. If the POWER lamp is flashing green, this indicates that the printer is warming up or is processing a print job.</p> <p>If the POWER lamp flashes orange, or green and orange alternately, see "Handling Error Messages" on page 30.</p>
	Printer/computer incorrectly connected	Reconnect the printer cable to the correct port, with the correct cable. See the <i>S630 User's Guide</i> on the Setup Software & User's Guide CD-ROM for more information.









PROBLEM	POSSIBLE CAUSE	TRY THIS
Printer is not responding (continued)	Bad cable	Replace the printer cable.
	Computer and/or printer needs to be reset	Reboot the computer and/or reset the printer. <ol style="list-style-type: none"> 1. To reboot the computer, close all open applications, then restart. 2. To reset the printer, turn it off, then on again.
Printer tried to print but no ink on paper	Ink tanks are not seated properly	Check the ink tanks, and reseal them if necessary. See “Replacing Ink Tanks” on page 20.
	Printhead clogged	Verify that the printhead is working properly. See “Printing a Nozzle Check Pattern” on page 20. or “Cleaning the Printhead” on page 22. If necessary, perform multiple printhead cleanings. See the <i>S630 User’s Guide</i> on the Setup Software & User’s Guide CD-ROM for more information.
	Ink tanks may need to be replaced	Verify that you have sufficient ink in the ink tanks. See “Monitoring Ink Levels” on page 19. If necessary, replace the ink tanks. See “Replacing Ink Tanks” on page 20.
	Printhead may need to be replaced	Verify that the printhead is working properly. See “Printing a Nozzle Check Pattern” on page 20 or “Cleaning the Printhead” on page 22. If necessary, perform multiple printhead cleanings. See “Cleaning the Printhead” on page 22 or the <i>S630 User’s Guide</i> on the Setup Software & User’s Guide CD-ROM for more information.





Troubleshooting Printed Output



PROBLEM	POSSIBLE CAUSE	TRY THIS
Printed colors are incorrect	One or more ink tanks installed in the wrong position	Verify that each ink tank is lined up with the correct color label in the printhead. For more information, see “Replacing Ink Tanks” on page 20. If ink tanks were placed in the incorrect color slots in the printhead, after switching the tanks to their correct slots, perform at least two printhead cleanings to remove the incorrect residual colors from the printhead. For procedures, see “Cleaning the Printhead” on page 22.
	Incorrect Color Adjustment setting	 WINDOWS On the Main tab of the S630 Properties window, confirm that Color Adjustment is set to Auto. If Manual is set, click the Defaults button on the Manual Color Adjustment window.

PROBLEM	POSSIBLE CAUSE	TRY THIS
Printed colors are incorrect <i>(continued)</i>	Print Mode is improperly set	 Mac OS In the Print dialog box, select the appropriate Print Mode setting.
	Incorrect media type	 WINDOWS On the Main tab of the S630 Properties window, confirm that the Media Type selected matches the paper loaded.  MAC OS In the Print dialog box, confirm that the Media Type selected matches the paper loaded.
	Print Quality is improperly set	 WINDOWS On the Main tab of the S630 Properties window, select the appropriate Print Quality setting: High, Standard, Draft or Custom.  MAC OS In the Print dialog box, select the Manual icon, then click the Details button. In the Detailed Setting window, slide the Print Quality bar to select your preferred output quality.
Printed output is faded or unclear	Media not loaded print-side up	Check that your media is placed in the printer facing in the correct direction. See “Loading Paper and Other Media” on page 4.
	Low ink	Verify that you have sufficient ink in the ink tanks. See “Monitoring Ink Levels” on page 19.
	Printhead nozzles clogged or damaged	Verify that the printhead is working properly. See “Printing a Nozzle Check Pattern” on page 20 and “Cleaning the Printhead” on page 22. If necessary, perform multiple printhead cleanings. See the <i>S630 User’s Guide</i> on the Setup Software & User’s Guide CD-ROM for more information.
	Ink tanks are not seated properly	Check the ink tanks, and reseal them if necessary. See “Replacing Ink Tanks” on page 20.
	Printhead needs to be aligned	Perform printhead alignment. See “Aligning the Printhead” on page 23.
Meaningless characters printed	Corrupted print instructions are stored in the printer buffer	Turn the printer off to clear the printer buffer. Cancel the print job from the computer. See “Cancelling a Print Job” on page 7. Turn the printer on again.
	Printer/computer not securely connected	Check the cable connections between the printer and the computer to verify that they are securely connected.







PROBLEM	POSSIBLE CAUSE	TRY THIS
Meaningless characters printed <i>(continued)</i>	Previous print job paused before it was finished	<p>If a previous print job was paused before it was printed, turn the printer and the computer off, then back on again, <i>or</i></p> <p> WINDOWS</p> <ol style="list-style-type: none"> 1. Click Start, Settings, Printers. 2. Double-click Canon S630 and cancel any unfinished print jobs. <p> MAC OS</p> <p>On your keyboard, press the Apple Command key () and the period key (.) at the same time. The print job will be cancelled and the paper ejected.</p>
	Incorrect printer driver selected	Check the Printer window to verify that the correct printer driver is selected.
	Bad (corrupted) file	Create the document again and print it. If it prints successfully, the original file was corrupted.
	ECP mode not set	Extended Capabilities (Parallel) Port, or ECP, provides faster data transfer between the computer and the printer. If the ECP setting is incorrect, it could result in incorrect print information going to the printer. See the <i>S630 User's Guide</i> on the Setup Software & User's Guide CD-ROM for instructions on how to check ECP settings and reconfigure if needed.





Handling Error Messages



PROBLEM	POSSIBLE CAUSE	TRY THIS
Printer does not print	When a printer error occurs, the POWER lamp flashes orange between green flashes. Count the number of orange flashes to determine and resolve the problem:	
	Alternately flashes green and orange (service error)	<ol style="list-style-type: none"> 1. Remove the paper from the printer, switch the printer off, then unplug it. 2. Reconnect the printer power and turn it back on. <p>If the same error message persists after restarting the printer, contact the Customer Care Center.</p>
	2 orange flashes (paper is out or not feeding correctly)	If no paper is loaded in the paper rest, or if paper is not loaded correctly, reload the paper correctly then press the Resume/Cancel button on the printer. See "Loading Paper and Other Media" on page 4 for how to load different types of media.

PROBLEM	POSSIBLE CAUSE	TRY THIS
Printer does not print <i>(continued)</i>	3 orange flashes (paper jam)	See the troubleshooting topic “Paper jams in the printer” on page 27.
	4 orange flashes (empty ink tank)	One of the ink tanks is empty. Replace it. See “Monitoring Ink Levels” on page 19 and “Replacing Ink Tanks” on page 20 for more information.
	7 orange flashes (defective printhead)	Remove and re-install the printhead. Also ensure that the protective tape has been removed. If re-installing the printhead does not resolve the problem, contact the Customer Care Center to replace it with a new one.
	8 orange flashes (waste tank almost full)	The printer has a built-in waste ink tank to hold the ink consumed during printhead cleaning. Press the Resume/Cancel button to restart printing, then contact the Customer Care Center to have the waste ink tank replaced immediately.
	Printer flashes green only	When the lamp flashes green, the printer is warming up or is receiving print data from the computer. This is not an error condition.
Low ink alert displays in the BJ Print Monitor	One or more of the ink tanks is low	<p>When Backgrounding is turned on, you can confirm the low ink alert in the BJ Print Monitor. See the <i>S630 User's Guide</i> on the Setup Software & User's Guide CD-ROM for more information on using the BJ Print Monitor.</p> <p>After the alert displays, you can continue printing for a short time, but have a replacement ready to install.</p> <p> WINDOWS The low ink alert displays in the BJ Status Monitor. Click the Ink Information tab to determine which ink tank is low.</p> <p> MAC OS The low ink alert displays in a status dialog before a print job starts.</p>
Error message displays in the BJ Status Monitor	Printer is out of paper Ink is low Paper jam Printhead installed incorrectly	<p> WINDOWS The BJ Status Monitor opens and displays a message when an error occurs.</p> <p>Read the error message, then click the Guide tab to display more information about solving the problem.</p> <p> MAC OS If Backgrounding is turned on with the Chooser, the BJ Print Monitor displays an error.</p> <p>Follow the instructions in the message to resolve the problem.</p> <p>See the <i>S630 User's Guide</i> on the Setup Software & User's Guide CD-ROM for more information on error messages.</p>

PROBLEM	POSSIBLE CAUSE	TRY THIS
System error message displays	System error occurred	<p>If a system error occurs, printing stops.</p> <p> WINDOWS A window displays the error message. System errors may include problems writing to LPT1 or USBPRN, application errors, or general protection faults. Make sure that the printer is turned on, the printer and computer are connected securely, and that the printer port is operating correctly.</p> <p> MAC OS The error message contains an error code *XXX, where * is a letter and XXX is a number, which represents the cause of the error. Make sure that the printer is turned on, the printer and computer are connected securely, and that the printer port is operating correctly.</p>

Customer Care Center

Canon offers a full range of customer technical support* options:

- For e-mail support, the latest driver downloads and answers to frequently asked questions (**www.usa.canon.com**)
- 24-hour, 7-day-a-week automated support for troubleshooting issues on most current products (**1-800-423-2366**)
- 24-hour, Fax-On-Demand System for product specifications and technical information (**1-800-526-4345**)
- Free technical support Monday–Saturday (excluding holidays) for products still under warranty** (**1-757-413-2848**)
- Technical support 7 days a week (excluding holidays) for products no longer under warranty, at \$9.99 per call (**1-757-413-2848**)



Note

Within Canada, call for technical support 24 hours a day, 7 days a week (**1-800-OK-CANON**).

* Support program specifics are subject to change without notice.

** Refer to the product information starting on page 47 for warranty details.

Chapter 5: The BJ Solution Software— Downloading Images

The BJ Solution software—a fun way to view, organize, adjust, and print images—includes ZoomBrowser EX and PhotoRecord (for Windows) and ImageBrowser (for Macintosh) and PhotoStitch (for Windows/Macintosh).

Easy-to-use features include:

- **Move, copy, or delete** images stored on computer disks.
- **Crop images** and **adjust colors** with simple editing tools.
- View all files within a specified folder simultaneously; zoom in and out for easier **visual searches**.
- View your files in **chronological order** via the “time tunnel” window.
- Display images one-by-one at full-screen size using the **slide show function**.
- Merge a series of images into a **panoramic view** using the PhotoStitch feature.
- Produce **photo-like prints** using Canon Photo Paper Pro or Canon Specialty Paper. (See “Recommended Paper Use” on page 3.) Print multiple images on a single sheet, and add customized borders and background designs. Even add titles and insert text in images and on pages. Or use a printing utility, **PhotoRecord**, to create your own **personal album**.

Minimum System Requirements



Windows

- Pentium 133 MHz, Windows 95/98 (32 MB RAM), Windows 2000/Windows NT 4.0 (64 MB RAM)



Mac OS

- Mac OS 8.1 or higher, 20 MB RAM

Installing the BJ Solution Software



To Install the BJ Solution Software in Windows:



Note

Driver features and screen shots described in this chapter, reflect Windows 98 and may be different for Windows 2000/Windows NT 4.0 users.

1. Close any open software applications.
2. Insert the BJ Solution CD in the CD-ROM drive. The Choose Destination Location dialog box will open. Click **Next**. To choose another installation folder, click **Browse**, then **OK**.



Note

If the setup program does not run automatically, click **Cancel**, then **Exit**. Click **Start**, then **Run**, and type `d:\setup.exe`, where `d` is your CD-ROM drive.

3. Select the software to be installed. Click **Next**. Follow the on-screen instructions.
4. When the Setup Complete dialog box appears, click **Finish**.



To Install the BJ Solution Software in Mac OS:

1. Close any open software applications and insert the BJ Solution CD in the CD-ROM drive.
2. Double-click the **CanonBJSD** icon on your desktop. Double-click **Install**.
3. Select the software to be installed, then click **Install**. The Choose a Folder dialog box will open.

4. Select the destination folder, then click **Choose**. Follow the on-screen instructions.
5. When the Installation Has Finished dialog box appears, click **OK**.

Accessing the Online Manual

The BJ Solution CD includes an electronic manual that is viewable with Adobe® Acrobat Reader 4.0. Follow the instructions below to install Acrobat Reader, which will enable you to view or print the *BJ Solution Disk User's Manual*.



To install Adobe Acrobat Reader in Windows:

1. On your computer, insert the BJ Solution CD in the CD-ROM drive. The BJ Solution installer program will begin. Click **Cancel**, then **Exit Setup**.
2. Click **Start**, then **Run**, then type **d:\readme\english\acrobat\ar405eng.exe**, where **d** is your CD-ROM drive. Follow the on-screen instructions.



To view the manual in Windows:

1. Insert the CD in the CD-ROM drive.
2. The BJ Solution installer program will begin. Click **Cancel**, then **Exit Setup**.
3. Click **Start**, then **Run**, then type **d:\readme\english\bj_solution_disk_manual.pdf** where **d** is your CD-ROM drive. Click **OK**.



To install Adobe Acrobat Reader in Mac OS:

1. On your computer, insert the BJ Solution CD in the CD-ROM drive.
2. From your desktop, double-click the **CanonBJSD** icon, then click **Readme, English, Acrobat, Reader Installer**. Follow the on-screen instructions.



To view the manual in Mac OS:

1. Insert the CD in the CD-ROM drive.
2. From your desktop, double-click the **CanonBJSD** icon. Double-click **Readme, English, BJ_Solution_Disk_Manual.pdf**.

Windows Users: Using Your Software



In this section you'll learn how to:

- Start ZoomBrowser EX
- Print on Canon Photo Paper Pro
- Merge photos to create a panoramic view

Starting ZoomBrowser EX

To Start ZoomBrowser EX:

1. Make sure the images are on your hard drive or other accessible media.
2. Double-click the **Canon ZoomBrowser EX** icon on the desktop to start the program.



Note

If the Canon ZoomBrowser EX icon does not appear on the desktop, click **Start, Programs, Canon Utilities, ZoomBrowser EX**, then **ZoomBrowser EX**.

3. From the **File** menu, select **Add Image Library**. Identify where the images are stored, and click **OK**. The images will display as thumbnails.



Printing on Canon Photo Paper Pro

To print on Canon Photo Paper Pro:

1. Select a folder or images for printing from the ZoomBrowser EX Display window and click **Print Layout** to start the PhotoRecord program. The selected images will display automatically.

- From the PhotoRecord window, you can drag images to change the layout, input descriptive text or captions, or add images.
- Click **Album Settings**. The Album Settings dialog box will appear.
- Make sure the **Canon S630** is the selected printer.
- Under **Album Type**, select **Canon perforated paper printing**. Canon Photo Paper Pro 4 x 6 will become the default media. The results will preview, click **OK**.
- Load a sheet of Canon Photo Paper Pro into the paper tray, then click **Instant Print**.



When using Canon Photo Paper Pro 4 x 6, insert the sheets in the direction shown and print on the glossier side. When finished, remove perforated edges. The results look just like a photograph.



Remember, when handling specialty media papers, always follow the instructions included with the media for the best printing results. See “Recommended Paper Use” on page 3 for a list of other fun-to-use Canon Specialty Papers.

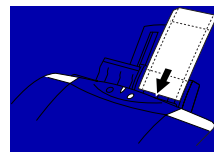

Merging Photos to Create a Panoramic View

You can merge a series of overlapping images into a seamless panoramic view.

To create a panoramic view:

- Select the images in the ZoomBrowser window, then click **Select All**. The images will highlight. From the **Edit** menu, select **PhotoStitch**. The PhotoStitch program will start.
- Follow the on-screen instructions to arrange, stitch, rotate, enlarge, or reduce your image.

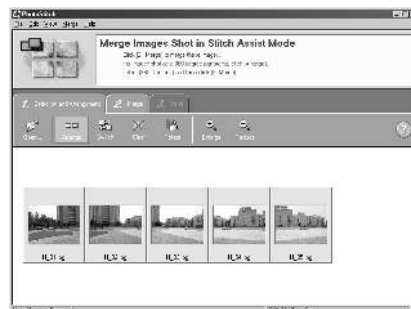

Windows Users: Uninstalling the BJ Solution Software



To uninstall the BJ Solution Software in Windows:

- Click **Start, Programs**. Click **Canon Utilities, ZoomBrowser EX**, then **ZoomBrowser Uninstall**, and follow the on-screen instructions.
- Click **Start, Programs**. Click **Canon Utilities, PhotoStitch**, then **PhotoStitch Uninstall**, and follow the on-screen instructions.

Mac OS Users: Using Your Software



In this section you'll learn how to:

- Start ImageBrowser
- Print on Canon Photo Paper Pro
- Merge photos to create a panoramic view

Starting ImageBrowser

To Start ImageBrowser EX:

1. Make sure the images are on your hard drive or other accessible media.
2. Double-click the **Canon ImageBrowser** icon on the desktop to start the program.
3. Double-click the folder for the device containing your images in the Browser window. The images will display as thumbnails.

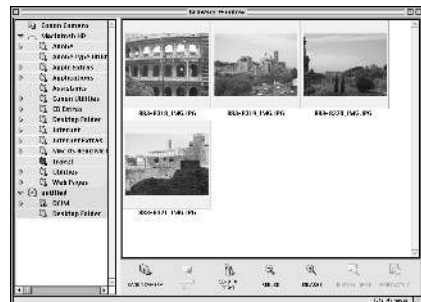

Printing on Canon Photo Paper Pro

To print on Canon Photo Paper Pro:

1. Select the images you desire to print, then click **Print Layout**. The selected images will display automatically.
2. From the Browser window, you can drag images to change the layout, input descriptive text or captions, or add images.
3. Click **Layout Options** in the Print window. The Layout Options dialog box will open.
4. Under **Layout Type**, select **Canon perforated paper**. Canon Photo Paper Pro 4 x 6 will become the default media. Results will preview, then click **OK**.
5. The Paper Registration dialog box will open. Click **OK**.
6. In the Page Setup dialog box, select the **Paper Size** menu and select **Custom 1 - 3**.
7. Click **Custom**. The Custom dialog box will open. Type the Photo Paper Pro values found in the Paper Registration dialog box. Click **Apply**. Make sure to save your setting for future use.
8. Click **OK** in the Page Setup dialog box. The paper size is registered.



Now that Canon Photo Paper Pro has been registered, you can simply select this custom paper size in the Page Setup dialog box for future use.

9. Click **Print**. The printer driver setup screen will open.
10. Load a sheet of Canon Photo Paper Pro into the paper tray. Click **Print**.

When using Canon Photo Paper Pro 4 x 6, insert the sheets in the direction shown and print on the glossier side. When finished, remove perforated edges. The results look just like a photograph.

**Note**

Remember, when handling specialty media papers, always follow the instructions included with the media for the best printing results. See “Recommended Paper Use” on page 3 for a list of other fun-to-use Canon Specialty Papers.

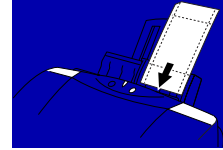

Merging Photos to Create a Panoramic View

You can merge a series of overlapping images into a seamless panoramic view.

To create a panoramic view:

1. Select the images in the Browser window, then click **Select All**. The images will highlight. In the **Edit** menu, select **PhotoStitch**. The PhotoStitch program will start.
2. Follow the on-screen instructions to arrange, stitch, rotate, enlarge, or reduce your image.

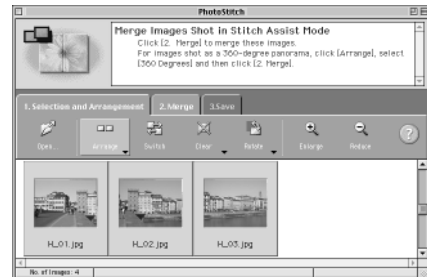

Mac OS Users: Uninstalling the BJ Solution Software



To uninstall the BJ Solution Software in Mac OS:

- Drag its folders to the **Trash** icon located on your desktop.

Installing the Printer Driver

If you are re-installing the printer driver, first follow the uninstall procedures on page 43 to remove the existing printer driver before you re-install.



To install the printer driver in Windows:



For Windows 2000 or Windows NT 4.0, refer to the README.TXT file on the S630 Setup Software & User's Guide CD-ROM.

1. Turn both the printer and computer off.
2. Make sure the cable between the printer and computer (USB or parallel) is securely connected.
3. Turn the computer on, and close any open software applications. Insert the S630 Setup Software & User's Guide CD-ROM in the CD-ROM drive. The setup program should run automatically.



If the printer was on when the setup program started, the Add New Hardware Wizard will appear. Do NOT use the wizard—click **Cancel** to close the window and continue.

If the setup program does not run automatically, click **Start**, then **Run**, then type **d:\msetup.exe** (where **d** is the CD-ROM drive).

4. Read the Welcome screen, then click **Next**. Read the License Agreement, then click **Yes**. When the main menu appears, click **Install Software**.
If a message prompts you to restart Windows, remove the CD-ROM, then click **OK**. After the computer restarts, re-insert the CD-ROM and continue.
5. Click **Start**. (If the Printer Driver button is not red, select **Printer Driver**, then click **Start**.) The printer driver will start loading automatically.
6. TURN THE PRINTER ON so the printer port can be automatically detected. The software will begin identifying the printer port being used.

 If your computer cannot detect a printer port, see the tip, “Computer cannot detect a printer port” on page 27.

7. When the Terminate Installation window appears, click **OK**. If you are prompted to restart the computer, click **Yes**. When the installation process has completed, click **Exit**.
8. Align the printhead. (See “Aligning the Printhead” on page 23.)



To install the printer driver in Mac OS:

1. Prepare your Mac (if needed).
 - If you have an iMac[®] with Mac OS 8.1, download and install the iMac Update 1.0 from www.apple.com.
 - If you have multiple users set up in OS 9, log in as the Owner.
 - To install the printer to a network, see the *S630 User's Guide* on the Setup Software & User's Guide CD-ROM.
2. Insert the S630 Setup Software & User's Guide CD-ROM in the CD-ROM drive.
3. Open the Printer Driver folder on the CD-ROM, then double-click the **Installer** icon.
4. Read the License Agreement, then click **Accept**.
5. Click **Install**. The printer driver will load automatically.

 **Note** If the message “No other applications can be running...” displays, click **Continue**.

6. When the installation process has completed, TURN ON THE PRINTER, then click **Restart**.
7. After the computer restarts, select the **Apple** menu, then **Chooser**.
8. Click the **S630** icon in the **Chooser**.

 **Note** To use the BJ Print Monitor, click the **Background** button to the **On** position. For instructions on using this feature, see the *S630 User's Guide* on the Setup Software & User's Guide CD-ROM.

9. Close the **Chooser**.
10. Align the printhead. (See “Aligning the Printhead” on page 23.)

Uninstalling the Printer Driver



To uninstall the printer driver in Windows:

1. Click **Start, Programs**, then **Canon 630**.
2. Click **Uninstall**.
3. Click **Yes** to confirm that you want to uninstall the printer driver.
4. Restart your computer.



To uninstall the printer driver in Mac OS:

1. Insert the S630 Setup Software & User's Guide CD-ROM in the CD-ROM drive, then click the **CD-ROM** icon.
2. Double-click **Installer**.
3. Read the License Agreement, then click **Accept**.
4. Select **Uninstall** from the drop-down list at the top left of the dialog box, then click the **Uninstall** button on the bottom right.
5. Follow the on-screen instructions.
6. When the uninstall is complete, click **Quit**.
7. Click **Restart** when prompted to restart your computer.

Registering Your Canon Product

If you didn't register your product during installation, follow these steps.



To register your Canon product in Windows:

1. Insert the S630 Setup Software & Reference Guide CD-ROM in the CD-ROM drive.
2. When the Canon installation screen launches, click **Install Software**.
3. Click **Utilities**, then **Product Registration**.
4. Click **Product Registration** and follow the on-screen instructions to register your product. The serial number is located on the inside of the printer, to the right of the printhead.



To register your Canon product in Mac OS:

1. Insert the S630 Setup Software & Reference Guide CD-ROM in the CD-ROM drive.
2. From the Canon BJ window, double-click the **Product Registration** icon.
3. Click the **Register Now** button and follow the on-screen instructions to register your product. The serial number is located on the inside of the printer, to the right of the printhead.

Safety Information

Warnings and Cautions

This guide uses the following icons to indicate situations that could cause damage or injury:



Always follow the instructions provided in Warnings to prevent potential or serious personal injury or death as a result of careless operation of the equipment.



Always follow the instructions provided in Cautions to prevent minor injuries to yourself or damage to the equipment as a result of careless operation of the equipment.

Read and follow all of these cautions and warnings to ensure the safe use of the printer. To avoid the hazards of fire, personal injury, or damage to the printer, never attempt to use the printer in any way other than the methods described in this guide.

Choosing a Location



Never place the printer near flammable solvents such as alcohol, thinner, etc. To avoid the hazards of fire or electric shock, keep all flammable liquids away from the printer.

- Never set the printer on a surface that is unstable or subject to excessive vibration. The printer could tip or fall and cause injury.
- Never use the printer in a location that is subject to high humidity, dust, high temperatures, or direct sunlight.
- Set up and use the printer in a location where ambient temperature is within 41°F–95°F (5°C–35°C) and 10%–90% humidity with no condensation.



Never place the printer on a thick carpet or rug. Fibers or dust entering the printer could cause a fire.



Keep the power outlet for the printer free of all obstacles so you can unplug the power cord at any time. Such obstacles could prevent you from unplugging the printer when a printer fault occurs and cause a fire or electric shock. The socket-outlet shall be installed near the equipment and shall be easily accessible.

- Always carry the printer with both hands holding both ends of the printer. To avoid dropping the printer and causing injury, always carry it carefully when moving it to another location.

Power Supply



Never attempt to plug the power cord into a power outlet when your hands are wet. To avoid electric shock, make sure that your hands are dry.

- Always push the plug completely into the power outlet. A loose or poorly connected plug could cause a fire or electric shock.



Never cut, modify, stretch, bend, or twist the power cord, and never place heavy objects on the power cord. A power leak from a damaged power cord could cause a fire or electric shock.



Never plug the printer power cord into a power outlet (power board, double adapter, etc.) that is shared by other devices or office equipment. To prevent the hazards of fire or electric shock, avoid overloading power points.

- Never use the printer if the power cord is bundled or knotted. To prevent the hazards of fire or electric shock, make sure the power cord is straight.



If you detect smoke, unusual odors, or strange noises around the printer, immediately press the POWER button to turn off the printer and disconnect the power plug. To avoid fire or electric shock, never use the printer under these conditions. Call the Customer Care Center.

- Always grasp the plug when you unplug the power cord. Pulling on the power cord could damage the cord and cause a fire or electric shock.



Never use an extension cord. To avoid a fire or electric shock, always plug the power cord directly into the power outlet.



Never use a power supply voltage other than that supplied in the country where you purchased the printer. Using incorrect voltage could cause a fire or electric shock. The correct power supply voltage for this printer is AC 120V, 60 Hz.

Cleaning and Maintaining the Printer



Use only a slightly damp cloth to clean the printer. Never use flammable solvents like alcohol, benzene, thinner, etc. If a flammable solvent contacts an electrical component inside the printer, a fire or electric shock could result.



Always unplug the printer power cord before you clean the printer. If you mistakenly turn on the printer while cleaning it, you could touch moving components inside the printer and suffer injury.



Never attempt to disassemble or modify the printer. The printer contains high voltage components which could cause a fire or serious electric shock.

Working Around the Printer



Never use flammable sprays near the printer. Gases in the spray could cause a fire or electric shock if they come in contact with electrical components inside the printer.



Never insert your fingers or hands inside the printer while it is printing. The printer contains moving parts which could cause injury.



Never place anything on top of the printer, especially metal objects (paper clips, staples, etc.), or containers with flammable solvents (alcohol, thinners, etc.) Objects falling into the printer could cause a fire or electric shock.



If any foreign object, especially a piece of metal or liquid, falls into the printer, immediately press the POWER button to turn off the printer, unplug the power cord, then call the Customer Care Center. Continuing to use the printer after a foreign object has fallen into it could cause a fire or electric shock.

Printhead and Ink Tanks



For safety, always store printhead and ink tanks out of the reach of small children. If a child accidentally licks or ingests any ink, consult a physician immediately.

Never subject a printhead or ink tank to shocks or excessive vibration. Shaking could cause ink to leak and stain clothing.



Never touch the printhead or electrical contacts on a printhead immediately after removing it from the printer. These metal parts become very hot during printing and could cause minor burns.

Turning Off the Printer

To avoid printer malfunction always use the POWER button to turn the printer on and off. Never remove the power cord from the power outlet until you have turned off the printer by pressing the POWER button. After the POWER lamp goes out, you can unplug the power cord from the power outlet.

Using the Printer Near Appliances and Fluorescent Lamps

Allow at least 6 inches clearance between the printer and another appliance or a fluorescent lamp. Electrical noise generated by a fluorescent lamp placed too close to the printer could cause the printer to malfunction.

Regulatory Information

Color Printer Model: K10198 (S630)

This device complies with Part 15 of the FCC Rules. Operation is subject to the following two conditions: (1) This device may not cause harmful interference, and (2) this device must accept any interference received, including interference that may cause undesired operation.

Note: This equipment has been tested and found to comply with the limits for a Class B digital device, pursuant to Part 15 of the FCC Rules. These limits are designed to provide reasonable protection against harmful interference in a residential installation. This equipment generates, uses and can radiate radio frequency energy and, if not installed and used in accordance with the instructions, may cause harmful interference to radio communications. However, there is no guarantee that interference will not occur in a particular installation. If this equipment does cause harmful interference to radio or television reception, which can be determined by turning the equipment off and on, the user is encouraged to try to correct the interference by one or more of the following measures:

- Reorient or relocate the receiving antenna.
- Increase the separation between the equipment and receiver.
- Connect the equipment into an outlet on a circuit different from that to which the receiver is connected.
- Consult the dealer or an experienced radio/TV technician for help.

Use of a shielded cable is required to comply with Class B limits in Subpart B of Part 15 of the FCC Rules.

Do not make any changes or modifications to the equipment unless otherwise specified in the manual. If such changes or modifications should be made, you could be required to stop operation of the equipment.

Canon U.S.A., Inc.
Digital Home and Personal Systems Division
2995 Red Hill Avenue
Costa Mesa, CA 92626
1-800-423-2366

Canadian Radio Interference Regulations

This digital apparatus does not exceed Class B limits for radio noise emissions from a digital apparatus as set out in the interference-causing equipment standard entitled “Digital Apparatus”, ICES-003 of the Industry Canada.

Cet appareil numérique respecte les limites de bruits radio électriques applicables aux appareils numériques de Classe B prescrites dans la norme sur le matériel brouilleur: “Appareils Numériques”, NMB-003 édictée par l’Industrie Canada.

Product Specifications

System Requirements

Windows 95/98:	486 processor; 16 MB RAM; 15 MB free hard disk space
Windows Me:	Pentium® processor, 150MHz; 32 MB RAM; 15 MB free hard disk space
Windows 2000:	Pentium processor, 133MHz or faster; 32 MB RAM for Professional, 64MB RAM for Server; 25 MB free hard disk space
Windows NT 4.0:	Pentium processor; 16 MB RAM; 25 MB free hard disk space
Macintosh:	OS 8.1 - 9.x; USB port; 10 MB RAM; 30 MB free hard disk space
	 Note The BJ Status Monitor cannot be used when the printer is used in a network operating environment.
Printing method:	Bubble Jet Printing, Serial
Printing resolution:	Print Quality (media): High (specialty media) Horizontal x Vertical: 2400 x 1200
Print speed:	(All print speeds are based on high-speed draft mode. Print speeds will vary depending on system configuration, software, document complexity, print mode and page coverage.): Black printing 17 ppm Color printing 12 ppm
Print direction:	Bi-directional
Print width:	8.0 inches max. (203 mm)
Interface (parallel):	IEEE 1284-compatible
Interface (USB):	USB 1.1-compatible
Interface connector (parallel):	Amphenol 57-40360 or equivalent
Interface connector (USB):	USB standard Series B receptacle
Recommended printer cable (parallel):	
Material:	AWG28 or larger
Type:	Twisted-pair shielded cable
Length:	Up to 6.5 feet (2.0 m)
Connectors:	Amphenol 30360 or equivalent
Recommended printer cable (USB):	
Material:	AWG28 (data wiring pair) or AWG20 to 28 (distribution pair)
Type:	Twisted-pair shielded cable
Length:	Up to 16.4 feet (5.0 m)
Connectors:	USB standard Series B pluggable
Acoustic noise level:	Approx. 39 dB in the highest print quality mode (per ISO 9296)
Operating environment:	Temperature: 41°F to 95°F (5°C to 35°C) Humidity: 10% to 90% (no condensation)
Storage environment:	Temperature: 32°F to 95°F (0°C to 35°C) Humidity: 5% to 90% (no condensation)

Power supply:	AC 120 V, 60 Hz
Power consumption:	Off: Approx. 1.5 W (to shut down completely, disconnect power cord) Standby: Approx. 3 W Printing: Approx. 33 W
Dimensions:	(with paper rest and paper output tray retracted) 16.9" (W) x 11.6" (D) x 7" (H)
Weight:	Approx. 11 lb. (5 kg)
Feed method:	Continuous feed through auto sheet feeder for High Resolution Paper, plain paper, envelopes, Transparencies, Glossy Photo Paper, Glossy Photo Film, Glossy Photo Cards, Banner Paper, Greeting Cards, Magnet Sheets, T-Shirt Transfers
Sheet feeder capacity:	
Plain paper (17 lb.)	100 sheets max.
High Resolution Paper	80 sheets max.
Envelopes	10 envelopes max.
Transparencies	30 sheets max.
Glossy Photo Paper	10 sheets max.
High Gloss Photo Film	1 sheet
Glossy Photo Cards	20 sheets max.
Banner Paper	1 sheet (can print up to 6 connected sheets)
Photo Paper Pro	1 sheet
Photo Paper Pro 4 x 6	20 sheets
Greeting Cards	1 sheet
T-Shirt Transfers	1 sheet
Ordinary print media:	Weight: 17–28 lb. Regular size: Letter, Legal, standard #10 and European DL envelopes Custom size: 3.54" to 8.5" (W) x 4.72" x 23" (H)
Graphic image printing:	Data format: Canon extended mode; raster image format Resolution: Canon extended mode; 600, 1200, 2400 dpi
Printhead:	Black nozzles: 320 (600 dpi) Color nozzles: 256 (1200 dpi)
Ink Tank BCI-3e:	Ink colors: Black, Cyan, Magenta, Yellow
Black ink tank capacity:	Approx. 695 sheets (1500 characters per page, normal text)
Ink tank capacities:	(Based on ISO JIS-SCID No. 5 Pattern on plain paper with Plain Paper selected for the Media Type in the Windows ME, Windows 98 and Windows 95 printer driver for this printer) Black: Approx. 1250 sheets Cyan: Approx. 460 sheets Magenta: Approx. 395 sheets Yellow: Approx. 300 sheets
Resident print control mode:	Canon extended mode
Receiver buffer:	62KB

Limited Warranty—U.S. Only

The limited warranty set forth below is given by Canon U.S.A., Inc. ("Canon") with respect to the Canon brand computer peripheral product (the "product") that you have purchased, when purchased and used in the United States. The product that you have purchased is the only product to which this warranty card and the limited warranty provided by Canon and stated on the card apply.

Your product, when delivered to you in new condition in its original container, is warranted against defects in materials or workmanship as follows: for a period of one (1) year from the date of original purchase, defective parts or a defective product returned to a Canon repair facility or a Canon Authorized Service Facility (“ASF”) for such product, as applicable, and proven to be defective upon inspection, will be exchanged for new or comparable rebuilt parts, or a refurbished product, as determined by the Canon repair facility or the ASF. Warranty repair or replacement shall not extend the original warranty period of the defective product. This limited warranty does not cover any supplies or accessories, including without limitation, ink tanks, as to which there shall be no warranty or replacement.

This limited warranty shall only apply if the product is used in conjunction with compatible computer equipment and compatible software, as to which items Canon shall have no responsibility.

Non-Canon brand equipment and software that may be distributed with the product are sold “as is,” without warranty of any kind by Canon, including any implied warranty regarding merchantability or fitness for a particular purpose, and all such warranties are disclaimed. The sole warranty, if any, with respect to such non-Canon brand items is given by the manufacturer or producer thereof.

This limited warranty covers all defects encountered in normal use of the product, and does not apply in the following cases:

- (a) Loss of or damage to the product due to abuse, mishandling, improper packaging by you, alteration, accident, electrical current fluctuations, failure to follow operating, maintenance or environmental instructions prescribed in Canon’s instruction manual, or service performed by other than a Canon repair facility or an ASF.
- (b) Use of parts or supplies (other than those sold by Canon) that cause damage to the product or cause abnormally frequent service calls or service problems.
- (c) If the product has had its serial number or dating altered or removed.

NO IMPLIED WARRANTY, INCLUDING ANY IMPLIED WARRANTY OF MERCHANTABILITY OR FITNESS FOR A PARTICULAR PURPOSE, APPLIES TO THE PRODUCT AFTER THE APPLICABLE PERIOD OF THE EXPRESS LIMITED WARRANTY STATED ABOVE, AND NO OTHER EXPRESS WARRANTY OR GUARANTY, EXCEPT AS MENTIONED ABOVE, GIVEN BY ANY PERSON OR ENTITY WITH RESPECT TO THE PRODUCT SHALL BIND CANON. (SOME STATES DO NOT ALLOW LIMITATIONS ON HOW LONG AN IMPLIED WARRANTY LASTS, SO THE ABOVE LIMITATION MAY NOT APPLY TO YOU.) CANON SHALL NOT BE LIABLE FOR LOSS OF REVENUES OR PROFITS, INCONVENIENCE, EXPENSE FOR SUBSTITUTE EQUIPMENT OR SERVICE, STORAGE CHARGES, LOSS OR CORRUPTION OF DATA, OR ANY OTHER SPECIAL, INCIDENTAL OR CONSEQUENTIAL DAMAGES CAUSED BY THE USE OR MISUSE OF, OR INABILITY TO USE THE PRODUCT, REGARDLESS OF THE LEGAL THEORY ON WHICH THE CLAIM IS BASED, AND EVEN IF CANON HAS BEEN ADVISED OF THE POSSIBILITY OF SUCH DAMAGES. IN NO EVENT SHALL RECOVERY OF ANY KIND AGAINST CANON BE GREATER IN AMOUNT THAN THE PURCHASE PRICE OF THE PRODUCT SOLD BY CANON WHICH CAUSED THE ALLEGED DAMAGE.

WITHOUT LIMITING THE FOREGOING, YOU ASSUME ALL RISK AND LIABILITY FOR LOSS, DAMAGE OR INJURY TO YOU AND YOUR PROPERTY AND TO OTHERS AND THEIR PROPERTY ARISING OUT OF USE OR MISUSE OF, OR INABILITY TO USE THE PRODUCT NOT CAUSED DIRECTLY BY THE NEGLIGENCE OF CANON. (SOME STATES DO NOT ALLOW THE EXCLUSION OR LIMITATION OF INCIDENTAL OR CONSEQUENTIAL DAMAGES, SO THE ABOVE EXCLUSION OR LIMITATION MAY NOT APPLY TO YOU.) THIS LIMITED WARRANTY SHALL NOT EXTEND TO ANYONE OTHER THAN THE ORIGINAL PURCHASER OF THE PRODUCT, OR THE PERSON FOR WHOM IT WAS PURCHASED AS A GIFT, AND STATES YOUR EXCLUSIVE REMEDY.

Canon offers a full range of customer technical support* options:

- For e-mail technical support, the latest driver downloads and answers to frequently asked questions (www.usa.canon.com)
- 24-hour, 7-day-a-week, automated support for troubleshooting issues on most current products (1-800-423-2366)
- 24-hour, Fax-On-Demand System for product specifications and technical information (1-800-526-4345)

- Free technical support Monday—Saturday (excluding holidays) for products still under warranty (1-757-413-2848)
- Technical support 7 days a week (excluding holidays) for products no longer under warranty, at \$9.99 per call (1-757-413-2848)

If the problem can't be corrected by using one of the above technical support options, you will be asked to follow the applicable procedures for warranty service. **Note that a dated proof of purchase (bill of sale) is required to verify eligibility at the time of service. This requirement will be satisfied by providing a copy of your dated bill of sale. You will also need to supply the product serial number.**

Carry-In/Mail-In

Carry-In/Mail-In is a service program by which your defective product is repaired by an ASF. The name and telephone number of the ASF(s) nearest to your location may be obtained from our Web site at: www.usa.canon.com, or by calling the Canon Customer Care Center at 1-800-423-2366. If shipping is involved, it is your responsibility to properly package and send your defective product, together with your dated proof of purchase, a complete explanation of the problem and a return address, to the ASF at your expense. Do not include any other items with your product. The repair(s) covered by this limited warranty will be made and the product will be returned to you without charge by the ASF. Repairs not covered under this limited warranty will be charged to you at such costs as each ASF may generally establish from time to time.

InstantExchange†

InstantExchange is a warranty program that expedites, usually by the next business day,^{††} the exchange of a defective product with a refurbished product. The refurbished product you receive will be covered by the balance of the period remaining on your original limited warranty. **Note that by using this service you will keep the replacement product that is sent to you, and your originally purchased product shall become the property of Canon.** InstantExchange warranty program service is available only during the express limited-warranty period for your product and only in the continental United States, Alaska and Hawaii during such period.

If the Canon Customer Care Center representative cannot correct the problem with your product over the telephone, and you elect InstantExchange warranty program service, the representative will issue you a reference number upon verification of warranty eligibility. You will be asked for information pertaining to your defective product and for a ship-to location for the replacement product (street address only). You must also provide a major credit card number that will be pre-authorized by Canon in an amount up to the cost of a new product at the time you elect InstantExchange warranty program service. **Your credit card number will be charged in an amount up to the cost of a new product** (i) if you do not return your defective product to a Canon repair facility by the date specified by Canon and in the manner described below; (ii) if the defect(s) in the product is/are not covered by this limited warranty; or (iii) if the warranty period on the product has expired or has not been sufficiently established by your supplying the appropriate documentation.

The Canon repair facility will ship out the replacement product via overnight courier, prepaid by Canon. After receipt of the replacement product (with instructions and a pre-paid return waybill), follow the instructions to ship the defective product to a Canon repair facility. You must return the defective product in the shipping carton in which the replacement product was packed (be sure to include your printhead and ink tanks), and you must include the reference number, **a copy of your dated proof of purchase** (bill of sale) and a complete explanation of the problem. **Do not include any other items in the return shipping container.**

This limited warranty gives you specific legal rights, and you may also have other rights that vary from state to state.

* Support program specifics are subject to change without notice.

† InstantExchange warranty program service is subject to availability of refurbished replacement units.

†† 9 a.m.–5 p.m. (local), Monday–Friday (excluding holidays). The Canon Customer Care Center must receive pertinent information by 3 p.m. (E.S.T.) to ensure next-business-day InstantExchange warranty program service (two-business-day InstantExchange warranty service for Alaska and Hawaii). Canon does not guarantee next-business-day service in the event of factors beyond Canon's reasonable control.

S630 Index

A

- adjusting
 - brightness..... 12
 - color balance..... 12
 - color saturation..... 12
 - paper thickness lever..... 5
 - print quality..... 10
- advanced print features 9
- aligning the printhead 23
- auto feed paper limits..... 4
- auto sheet feeder..... 5
- avoiding paper jams 5

B

- BJ Solution Software..... 33
 - installing 34
- brightness, adjusting..... 12

C

- cancelling print jobs, how to 7
- checking ink levels..... 19
- cleaning the printhead..... 22
- color balance, adjusting..... 12
- color saturation, adjusting..... 12
- customer care center, contacting..... 32

D

- default printer, setting..... 2
- driver
 - definition of..... 2
 - installing 41
 - recalling saved settings..... 17
 - removing 43
 - saving settings for future use 17
 - troubleshooting installation of 25
 - uninstalling..... 43

E

- edges, smoothing 13
- envelopes, how to load 6
- error messages, explanation of 30

F

- fixing problems, how to..... 25

G

- graphics, improving quality 11, 13
- grayscale..... 13

I

- Image Color Management (ICM)..... 13
- Image Optimizer 11
- ImageBrowser 38
- improving enlarged graphics 11, 13
- improving print quality..... 9
- ink tanks
 - monitoring levels in 19
 - replacing 20
- installing the printer driver 41

L

- loading envelopes..... 6
- loading paper and other media..... 5

M

- manually adjusting color settings 12
- media
 - loading 5
 - to avoid 4
 - types of 10
- monitoring ink levels 19

N

- nozzle check pattern, printing..... 20

O

- online manual, BJ Solution Software..... 35
- online product registration..... 43

P

- page setup 14
- panoramic view..... 37, 40
- paper
 - how many sheets can be used in auto feeder..... 4
 - loading 5
- paper jams, avoiding..... 5
- paper thickness lever 4, 5
- paper types to avoid 4
- perforated paper 37, 39
- Photo Optimizer 13
- Photo Paper Pro 36, 39
- PhotoStitch 37, 40
- POWER button..... 1
- POWER lamp..... 1
- powering up the printer 1
- print job, cancelling 7
- print quality
 - adjusting..... 10
 - controlling 9
- printer
 - choosing 2
 - setting as default..... 2
- printer driver, definition of 2
- printhead alignment 23
- printhead cleaning..... 22
- printing
 - adjusting brightness 12
 - adjusting color balance..... 12
 - adjusting color saturation 12
 - nozzle check pattern 20
 - smoothing rough edges 13
 - troubleshooting bad printouts 28
 - troubleshooting problems with 27
- printing color images in grayscale..... 13
- problems, what to do to fix..... 25
- product registration 43

Q

- quality of printing..... 9

R

- registering your product 43
- replacing empty ink tanks..... 20

S

- safety information 44
- scaled printing..... 16
- smoothing rough edges in images..... 13
- stopping a print job, how to 7
- system requirements 47

T

- tech support, how to contact 32
- thick paper, lever position for..... 4
- troubleshooting 25
 - error messages..... 30
 - installation 25
 - installing the print driver..... 25
 - printer hardware..... 27
 - software installation problems..... 25
- turning your printer on and off..... 1

U

- uninstalling the BJ Solution Software..... 38, 40
- uninstalling the print driver..... 43

W

- warranty 48

Z

- ZoomBrower EX..... 36

Ordering Information

For additional supplies, use the following descriptions and order numbers.

Description Order

Ink Tanks

BCI-3eC Cyan F47-3141-400
BCI-3eM Magenta F47-3151-400
BCI-3eY Yellow F47-3161-400
BCI-3eBk Black F47-3131-400

Canon Specialty Papers

Banner Paper (continuous/50 sheets) F51-2571-500
Glossy Photo Cards (4" x 6"/20 sheets) F51-2701-400
Glossy Photo Paper (8.5" x 11"/20 sheets) F51-2501-400
Greeting Cards 1/4-Fold (8.5" x 11"/20 sheets w/22 env) CST-6043-000
Greeting Cards 1/2-Fold (8.5" x 11"/15 sheets w/15 env) CST-6205-000
High Gloss Photo Film (8.5" x 11"/10 sheets) F51-2461-400
High Resolution Paper (8.5" x 11"/100 sheets) F51-2111-400
Magnet Sheets (8.5" x 11"/3 sheets) CST-6322-000
Photo Paper Pro 4" x 6" (20 sheets) F51-3441-400
Photo Paper Pro (8.5" x 11"/15 sheets) F51-3261-400
Transparencies (8.5" x 11"/50 sheets) F51-9701-510
T-Shirt Transfers (8.5" x 11"/10 sheets) CST-6178-000
T-Shirt Transfers (8.5" x 11"/250 sheets) CST-6044-000

Call **1-800-OK-CANON** to locate a dealer near you, or visit the Canon eStore at www.estore.usa.canon.com.



©2001 Canon U.S.A., Inc. Canon, BCI and Bubble Jet are trademarks of Canon Inc. All other product and brand names are trademarks of their respective owners. As an ENERGY STAR® partner, Canon U.S.A., Inc., has determined that this product meets the ENERGY STAR® guidelines for energy efficiency.

Quick Start Guide

Canon U.S.A., Inc.

One Canon Plaza, Lake Success, NY 11042, U.S.A.

Digital Home and Personal Systems Division

2995 Redhill Avenue, Costa Mesa, CA 92626, U.S.A.

Canon Inc.

30-2, Shimomaruko 3-chome, Ohta-ku, Tokyo 146-8501, Japan

Canon Australia Pty. Ltd.

1 Thomas Holt Drive, North Ryde, Sydney, N.S.W. 2113, Australia

Canon Canada, Inc.

6390 Dixie Road, Mississauga, Ontario, L5T 1P7, Canada

Canon Deutschland GmbH

Europark Fichtenhain A10, 47807 Krêfeld, Germany

Canon Europa N.V.

Bovenkerkerweg 59-61, 1185 EG Amstelveen, The Netherlands

Canon France S.A.

17 Quai du President Paul Doumer, 92414 Courbevoie Cedex, France

Canon Hongkong Co., Ltd.

10/F., Mirror Tower, 61 Mody Road, Tsimshatsui East, Kowloon, Hong Kong

Canon Latin America, Inc.

6505 Blue Lagoon Drive, Suite 325, Miami, FL 33126, U.S.A.

Canon Mexicana S. de R.L. de C.V.

Periferico Sur No. 4124 Col. Ex-Rancho de Anzaldo, C.P. 01900, Mexico, D.F.

Canon Singapore Pte. Ltd.

79 Anson Road, #09-01/06, Singapore 079906

Canon U.K. Ltd.

Woodhatch, Reigate, Surrey, RH2 8BF, United Kingdom