

COM-PAK BATH

WARMTH FOR EVERY MORNING



Thank you for your purchase! Question or problem? Let us solve it with a single phone call, email or online chat! We'll save you a trip back to the store!

Cadet Customer Service

Phone: **855.223.3887** (from US)

800.668.6663 (from Canada)

email: customerservice@cadetheat.com

Website and live chat: cadetheat.com (contact us)

For how-to videos or more information, please visit:

<http://cadetheat.com/install/bath>

CADET 
INVITING WARMTH

cadetheat.com

855.CADET.US

Vancouver, Washington



IMPORTANT INSTRUCTIONS

⚠ When using electrical appliances, basic precautions should always be followed to reduce the risk of fire, electric shock, and injury to persons, including the following:

1. Read all instructions before installing or using this heater.
2. This heater is hot when in use. To avoid burns, do not let bare skin touch hot surfaces. Keep combustible materials, such as furniture, pillows, bedding, papers, clothes, etc. and curtains at least 3 feet (0.9 meters) from the front of the heater and keep them away from the sides.
3. Extreme caution is necessary when any heater is used by or near children or invalids and whenever the heater is left operating and unattended.
4. Do not operate any heater after it malfunctions. Disconnect power at service panel and have heater inspected by a reputable electrician before reusing.
5. Do not use outdoors.
6. To disconnect heater, turn control(s) to off, and turn off power to heater circuit at main disconnect panel.
7. Do not insert or allow foreign objects to enter any ventilation or exhaust opening as this may cause an electric shock or fire, or damage the heater.
8. To prevent a possible fire, do not block air intakes or exhaust in any manner.
9. A heater has hot and arcing or sparking parts inside. Do not use it in areas where gasoline, paint, or flammable vapors or liquids are used or stored.
10. Use this heater only as described in this manual. Any other use not recommended by the manufacturer may cause fire, electric shock, or injury to persons.
11. This heater must be installed in a fixed, permanent location.

SAVE THESE INSTRUCTIONS

⚠ KNOW YOUR VOLTAGE! ⚠

If you are uncomfortable working with electricity, running electrical supply wire or installing a circuit breaker, please consult a licensed electrician. Make sure power to the heater is turned off at the main disconnect panel whenever doing any work on a heater. Serious injury or electrocution can result from electric shock.

- The multi-volt CB103T is factory set to 240 volts out of the box. It can be easily changed to 120 volts. Please don't assume you have 120 volts because your wires are black and white.

The multi-watt CB132T can only be connected to 240 or 208 volts and its wattage is adjustable.

- **CHECK YOUR BREAKER!** If you're replacing an existing heater, check the labels of the old heater and use the same voltage.

single-pole breaker

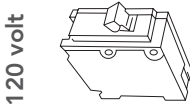

double-pole breaker

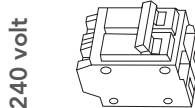

WARNING: Connecting a heater to a voltage higher than what's listed on its rating label will destroy the heater and could start a fire. A heater will not heat properly when connected to a voltage lower than what's listed on its rating label.

Unanswered questions? Call our technical support team in Vancouver, Washington toll free at **855.223.3887** or from Canada **800.668.6663**.

INSTALLATION INSTRUCTIONS

- All electrical work and materials must comply with the National Electric Code (NEC), the Occupational Safety and Health Act (OSHA), and all state and local codes. Canadian installations must comply with Codes Canada and provincial codes.
- Use copper conductors only.
- DO NOT install the heater directly above bathtub or sink. DO NOT install in shower stall area. Cadet recommends installing your heater at least 2 feet (61 cm) away to prevent contact with water.
- Heater must be installed in a wall can:
Model CB - wall can model CC or CCSM
- DO NOT install the heater in a floor, in the ceiling, below a towel bar, behind a door, or anywhere the air discharge may be blocked in any manner.
- To reduce the risk of fire, do not store or use gasoline or other flammable vapors and liquids in the vicinity of the heater.
- Connect grounding lead to grounding screw provided. Keep all foreign objects out of heater.
- CAUTION – High temperature, risk of fire, keep electrical cords, drapery, furnishings and other combustibles at least 3 feet (0.9 m) from the front of the heater and away from the side and rear.

TOOLS REQUIRED

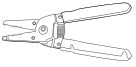

Wire Strippers



Wire Connectors



1/2" Wood Screws

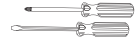

Straight and Phillips Screwdrivers



Drill and Drill Bits

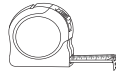

Tape Measure

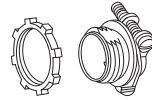

1/2" Cable Clamp Connector



Volt Meter

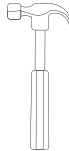

Hammer



Stud Finder

A multi-purpose tool or something to cut your existing drywall or gypsum board.

PARTS OF YOUR HEATER

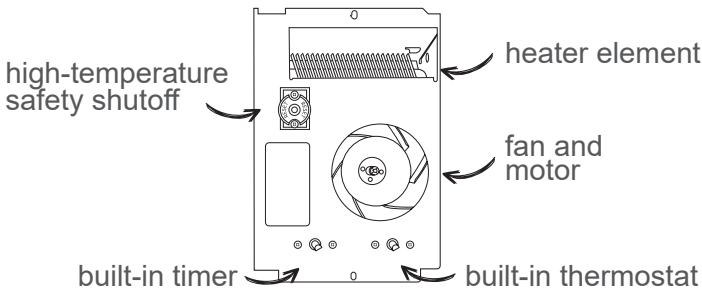

INSTALLATION INSTRUCTIONS

TIPS BEFORE YOU BEGIN

- **Verify power has been turned off before starting any work!**
- The Com-Pak Bath can only be mounted with the element up. It cannot be mounted in the ceiling or in the floor. For multiple heater wiring, see page 6. The Com-Pak Bath has a minimum clearance of 24" (61 cm) from the ceiling.
- For cleaner performance and longer heater life, install your heater 12 inches (30.5 cm) from the floor.
- All models can be installed to be Americans with Disabilities Act (ADA) compliant. Check your state and local requirements.
- A wall thermostat cannot be used with this heater.
- The wall can label arrows show the correct mounting orientation (arrows must point up).

STEP 1 Cut a hole in the wall next to a wall stud

If you haven't installed drywall yet, skip this step.

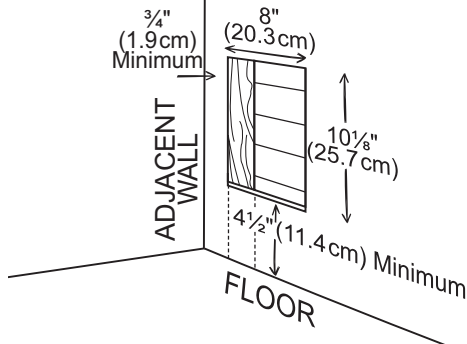

Figure 1

STEP 2 Locate or route electrical supply wires

Route the electrical supply wire from the circuit breaker to the heater location.

Remove a knockout from the wall can (best location is closest to heater wires) and attach the supply wire with a cable clamp connector (not included) leaving a minimum of 6 inches (15.2 cm) wire lead (See Figure 2).

STEP 3 Mount the wall can

If you haven't installed drywall yet, make sure the front of the wall can extends beyond the front edge of the wall stud to match the drywall depth (See Figure 2).

If you already have drywall installed, place the can into the cutout so the front is flush with the drywall.

Fasten the wall can to the stud with two screws through holes provided in the wall can (See Figure 2). As an option, the foam pad provided may be attached to the side of the wall can to square the wall can to the stud.

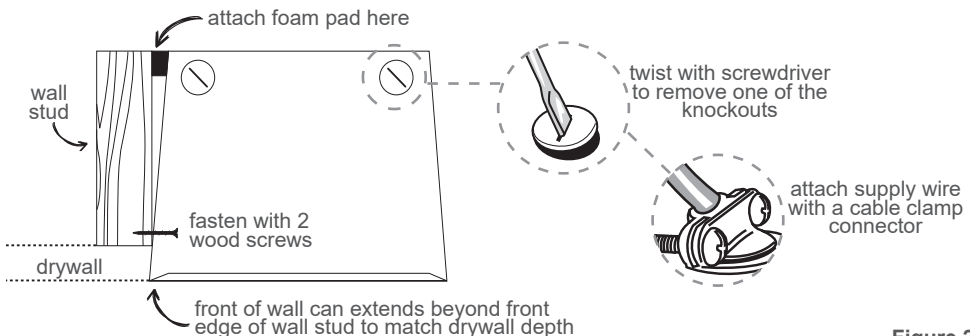

Figure 2
View from top of wall can

INSTALLATION INSTRUCTIONS

HOW TO CHANGE VOLTS (MULTI-VOLT MODEL CB103T ONLY)

Check supply voltage

Before installing your heater, it is extremely important you verify your supply voltage. The multi-volt Com-Pak Bath is 240 volts right out of the box. For 120 volts, you must change the heater wiring slightly.

If you're replacing an existing heater, check the label of the old heater and use the same voltage. If you need help, review the "KNOW YOUR VOLTAGE" section, or call a licensed electrician.

Select heater voltage

For 240 volts:

No need to do anything. The left side of your heater assembly should look like Figure 3. The red wire is not connected.

For 120 volts:

Remove the blue wire from terminal D and attach it to terminal A. Then attach the unused red wire to terminal D (see Figures 3 and 4). When you're done it should look like Figure 4.

Proceed to STEP 4.

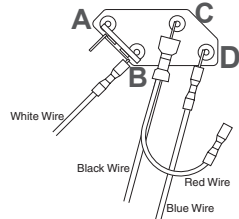

Out of the box 240 volts

Figure 3

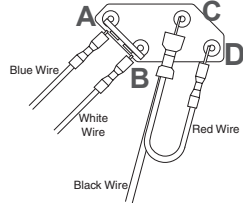

Changed to 120 volts

Figure 4

HOW TO CHANGE WATTS (MULTI-WATT MODEL CB132T ONLY)

Multi-watt element wire connections

Volts	Maximum Wattage Figure 5	Medium Wattage Figure 6	Lowest Wattage Figure 7
240V/208V	1300/975	800/600	500/375

Multi-watt models are factory set to maximum wattage (Figure 5). You can lower the wattage by changing the element wire connections on the left side of the heater assembly (See below).

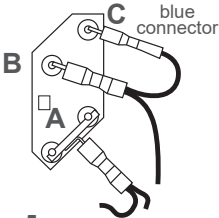

Figure 5

No change. tip: to remove terminals easier, pull and wiggle slightly back and forth at the same time

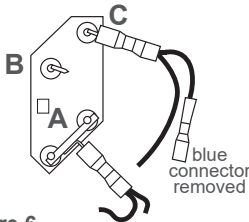

Figure 6

Disconnect BLUE connector from terminal C. Wrap loose wire end with electrical tape. Move YELLOW connector from terminal B to terminal C.

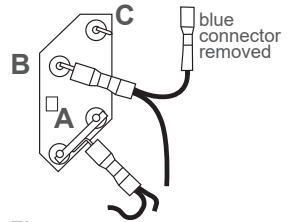

Figure 7

Disconnect BLUE connector at terminal C. Wrap loose wire end with electrical tape.

Do not disconnect the yellow connector from terminal A. Proceed to STEP 4.

INSERT THE HEATER ASSEMBLY IN THE WALL CAN

STEP 4 Wire connections

1. Your heater has two connection wires on the bottom. Your supply wire has two connection wires and a supply ground wire.

A. Connect supply ground wire to grounding screw in wall can (See Figures 8 and 9).

B. Connect one supply wire to one heater wire with a wire connector (not included).

For 240 or 208 volts, it doesn't matter which heater wire. Both supply wires (black and white) are hot. Wrap supply (white) wire with black tape to identify it as hot (Figure 8).

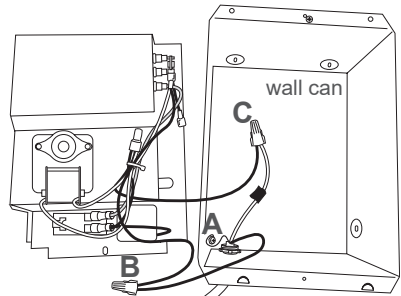

240 Volt

Figure 8

INSTALLATION INSTRUCTIONS

INSERT THE HEATER ASSEMBLY IN THE WALL CAN

For 120 volts (CB103T only), connect the neutral (white) supply wire to the black and white striped wire (Figure 9). This wire is only on CB103T models.

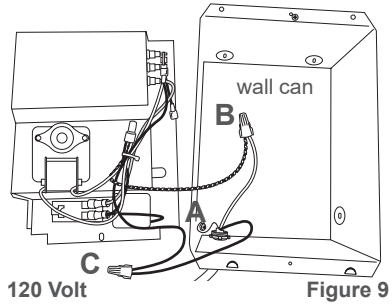

C. Connect the remaining supply wire to the remaining heater wire with a wire connector (not included) (See Figures 8 and 9).

2. Insert the bottom edge of the heater assembly into the D-shaped tabs at the bottom of the wall can.

3. Push all wires back into the bottom of the wall can. Make sure connections are tight and none of the wires are caught between the motor and the wall can, or pinched between the side of the heater and the wall can.

4. Attach the heater assembly at top of the wall can with screw provided.

STEP 5 Install grill

Attach grill with screws provided. Slide knobs onto shafts; timer on left and thermostat on right. Turn electrical power back on at the main disconnect panel.

Proceed to OPERATING INSTRUCTIONS.

More frequently asked questions on our website here: cadetheat.com/support/FAQ

MULTIPLE HEATERS ON ONE CIRCUIT BREAKER (240 OR 208 VOLTS ONLY)

More than one heater can be wired in parallel on the same circuit breaker (be sure to check national and local codes for safety requirements). Additional electrical supply wire and cable clamp connectors are required. The heaters must be in the same room.

Maximum amperage you can put on one circuit breaker is limited to 80% of the circuit breaker capacity.

1. Route the electrical supply wire from the circuit breaker to heater #1. Remove two knockouts and attach two sets of electrical supply wire with two cable clamp connectors (not included) leaving a minimum of 6 inches wire lead—one set from the circuit breaker, the other set to heater #2 (See Figure 10).
2. The two supply ground wires in the wall can of heater #1 need to make a 3-wire connection with the grounding screw. Attach a short copper ground wire to the grounding screw in the wall can. Connect this wire and the two supply ground wires with a wire connector (not included) (See Figure 10).
3. For heater #1, connect each heater wire with one of the supply wires going to the circuit breaker, and one of the supply wires going to heater #2. Each of the wires from heater #1 must have a 3-wire connection. For heater #2, make the connections in the wall can as shown below.

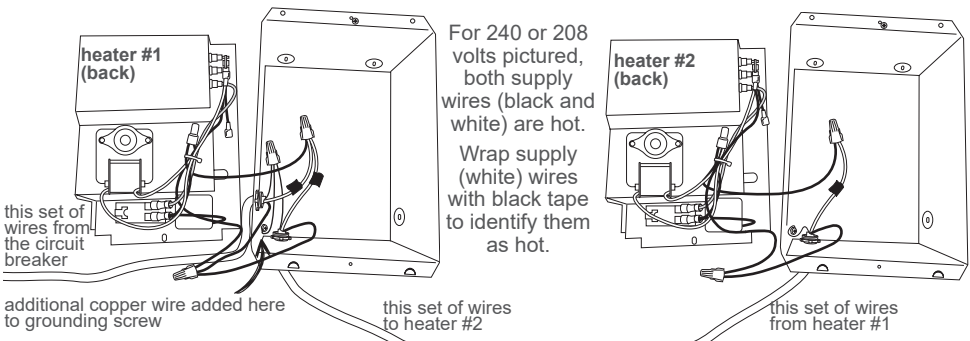

Figure 10

After making all connections, proceed with STEP 4 **Wire connections**, number 2 above.

OPERATING INSTRUCTIONS

1. Make sure all wires are properly connected and installation is complete before you turn on the heater.
2. Do not operate without grill.
3. Do not tamper with the high-temperature safety shutoff.

Complete installation

After installation, turn your heater to the highest setting and let it run for 30 minutes. Some smoking may occur as the element initially burns off residue from manufacturing.

If your heater shows signs of overheating, such as glowing red or repeatedly getting unusually hot and shutting off, immediately turn off the circuit breaker and review the "KNOW YOUR VOLTAGE" section or call us.

If the high-temperature safety shutoff trips more than once a day, replace the heater.

How to operate your heater

With the thermostat (knob on right side):

The room temperature is controlled by a thermostat located on the heater. Once installation is complete and power is on, follow the steps below.

1. Turn the thermostat knob all the way to the right.
2. When the room reaches your comfort level, turn the knob to the left, just until it clicks and the heater turns off. The heater will automatically keep the room temperature around this setting.
3. To reduce the room temperature, turn the knob to the left. To increase the room temperature, turn the knob to the right.

With the thermostat knob turned all the way to the left, the heater will not come on, but using the timer will operate the heater.

With the timer (knob on left side):

To operate the heater with the timer, turn timer knob to desired minutes. The timer cancels thermostat control while it's running. The heater stays on until time is up, even if your room temperature becomes warmer than the thermostat setting, then control of the heater returns to the thermostat.

INTERNAL HEATER WIRING DIAGRAMS

CB103T MULTI-VOLT

240 Volt Power Supply

120 Volt Power Supply

CB132T MULTI-WATT

240/208 Volt Power Supply

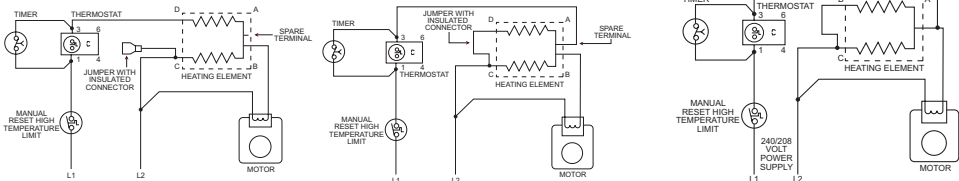

WARRANTY

For more effective and safer operation and to prolong the life of the heater, read the Owner's Guide and follow the instructions. Failure to properly maintain the heater will void any warranty and may cause the heater to function improperly.

LIMITED THREE YEAR WARRANTY: Cadet will repair or replace any Com-Pak Bath (CB) heater found to be defective within three years after the date of purchase.

These warranties do not apply:

1. Damage occurs to the product through improper installation or incorrect supply voltage;
2. Damage occurs to the product through improper maintenance, misuse, abuse, accident, or alteration;
3. The use of unauthorized accessories or unauthorized components constitutes an alteration and voids all warranties. Refer to Cadet website or call customer service at 855.223.3887 or 360.693.2505 for list of authorized accessories and components.

4. Cadet's warranty is limited to repair or replacement.
5. In the event Cadet elects to replace any part of your Cadet product, the replacement parts are subject to the same warranties as the product. The installation of replacement parts does not modify or extend the underlying warranties. Replacement or repair of any Cadet product or part does not create any new warranties.

If you believe your Cadet product is defective, please contact Cadet during the warranty period, for instructions on how to have the repair or replacement processed.

Parts and Service

Visit cadetheat.com/parts-service for information on where to obtain parts and service.

To register your product, visit cadetheat.com/product-registration

MAINTAINING YOUR HEATER

Clean heater at least every 6 months or as required. Do not lubricate motor.
WARNING – Risk of electrical shock, turn off power before removing grill.

1. Turn off power at the main disconnect panel.
2. Wait for the heater to cool.
3. Remove knobs and grill.
4. Wash grill with hot soapy water and dry.
5. Blow air through the heating element with a hair dryer or shop vacuum on blow cycle.
6. Clean the fan with a vacuum cleaner.
7. Replace grill and knobs.
8. Turn power back on at the main disconnect panel.

Any service other than cleaning should be performed by an authorized service representative.

High-temperature safety shutoff

All Com-Pak Bath heaters come with a built-in high-temperature safety shutoff that stops electricity flowing to the heater if it gets too hot inside. See TROUBLESHOOTING below if you're experiencing problems with your heater. The reset button is located in the center of the heater behind the removable plastic plug.

TROUBLESHOOTING		
Symptom	Problem	Solution
Heater smells after installation or not being used.	<ol style="list-style-type: none"> 1. Odor from element manufacturing process. 2. Dust or lint inside the heater. 3. Supply connections are loose. 	<ol style="list-style-type: none"> 1. In a new installation, some smoking may occur as the element initially burns off residue from manufacturing. It typically goes away within several hours. 2. Clean heater (see "MAINTAINING YOUR HEATER" above for instructions). 3. Turn off power at main disconnect panel. Inspect and/or tighten all the wire connectors inside the heater and at any connection points.
Heater doesn't work at all.	<ol style="list-style-type: none"> 1. Thermostat is set too low, or in no heat position. 2. Heater has tripped its built-in high-temperature safety shutoff and electricity has stopped flowing to the heater. 3. Circuit breaker is faulty. 4. Supply connections are loose. 5. Defective thermostat and/or timer. 	<ol style="list-style-type: none"> 1. Adjust thermostat to a higher temperature until heater operates. 2. TO RESET: Turn power off at main disconnect panel. Allow 10 minutes to cool. Make sure heater is not blocked and is clean. Push reset button. Restore power. If the high-temperature safety shutoff trips more than once a day, replace the heater. 3. Call a licensed electrician. 4. Turn off power at main disconnect panel. Inspect and/or tighten all the wire connectors inside the heater and at any connection points. 5. Replace the heater.
Breaker trips immediately after installing heater.	<ol style="list-style-type: none"> 1. A short circuit exists in the electrical supply wires or heater wiring. 2. Circuit is overloaded. 3. Circuit breaker is faulty. 	<ol style="list-style-type: none"> 1. An incorrect connection in the heater or electrical supply wires may cause sparking or arcing. Inspect all heater and electrical supply wiring insulation for damage or call an electrician. 2. Use a lower wattage heater, or reduce the number of heaters on the circuit. 3. Call a licensed electrician.
Heater blows cold air or doesn't get hot.	<ol style="list-style-type: none"> 1. Element has failed. 2. Incorrect supply voltage. 	<ol style="list-style-type: none"> 1. Replace heater. 2. Double check the voltage of the heater to make sure it matches the voltage of the circuit.
Fan/motor doesn't spin.	<ol style="list-style-type: none"> 1. Defective motor or motor out of alignment. 	<ol style="list-style-type: none"> 1. Replace motor.
Heater doesn't turn off.	<ol style="list-style-type: none"> 1. Incorrect heater wattage for room size. 2. Thermostat is defective or setting has been overridden by timer. 	<ol style="list-style-type: none"> 1. Install additional heaters if circuit allows. 2. Wait for the timer to run down or turn it down to '0' and turn the thermostat to its lowest setting. If heater continues to run (allow two minutes for thermostat to respond) the thermostat requires replacement.
Built-in high-temperature safety shutoff keeps tripping.	<ol style="list-style-type: none"> 1. Airflow is blocked. 	<ol style="list-style-type: none"> 1. Remove obstruction(s). Maintain minimum distances (See Page 2).

If you are uncomfortable working with electricity, running electrical supply wire or installing a circuit breaker, please consult a licensed electrician.



Reduce-Reuse-Recycle

This product is made primarily of recyclable materials. You can reduce your carbon footprint by recycling this product at the end of its useful life. Contact your local recycling support center for further recycling instructions.