

USER GUIDE

SMART COOKER™

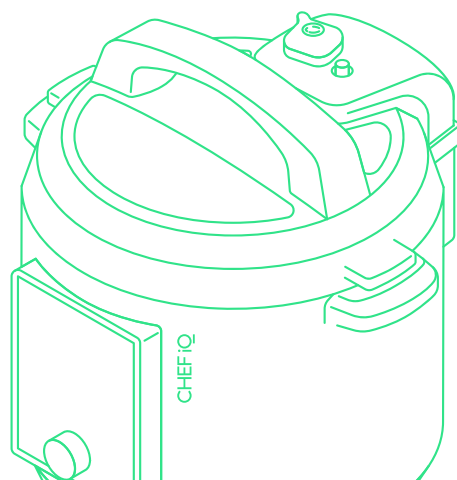
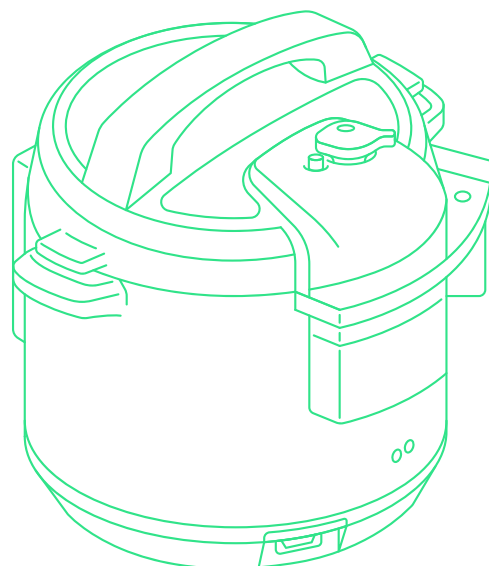
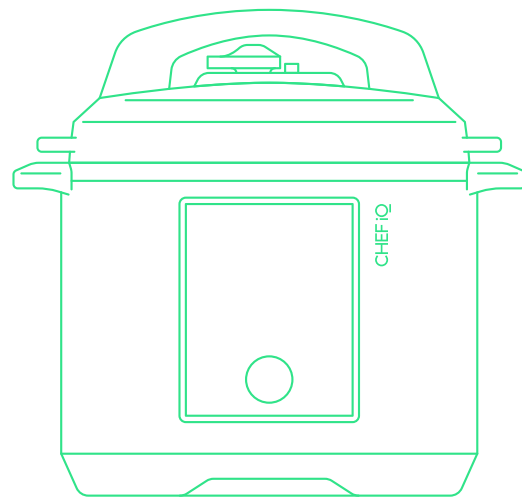
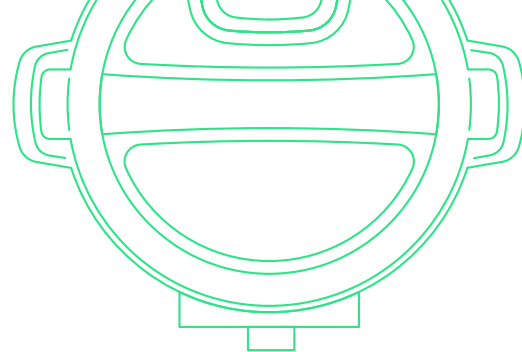

CHEF iQ®

TABLE OF CONTENTS

.....	33
.....	34
.....	35
.....	20
.....	24

INTRODUCTION

Welcome to CHEFiQ®! This guide contains detailed instructions for using your Smart Cooker™ including helpful cooking tips, important safety and warranty information, and much more.

Read through this guide to discover all that your Smart Cooker™ can do. And while we know you're excited to get cooking, please read through all safety information as well.

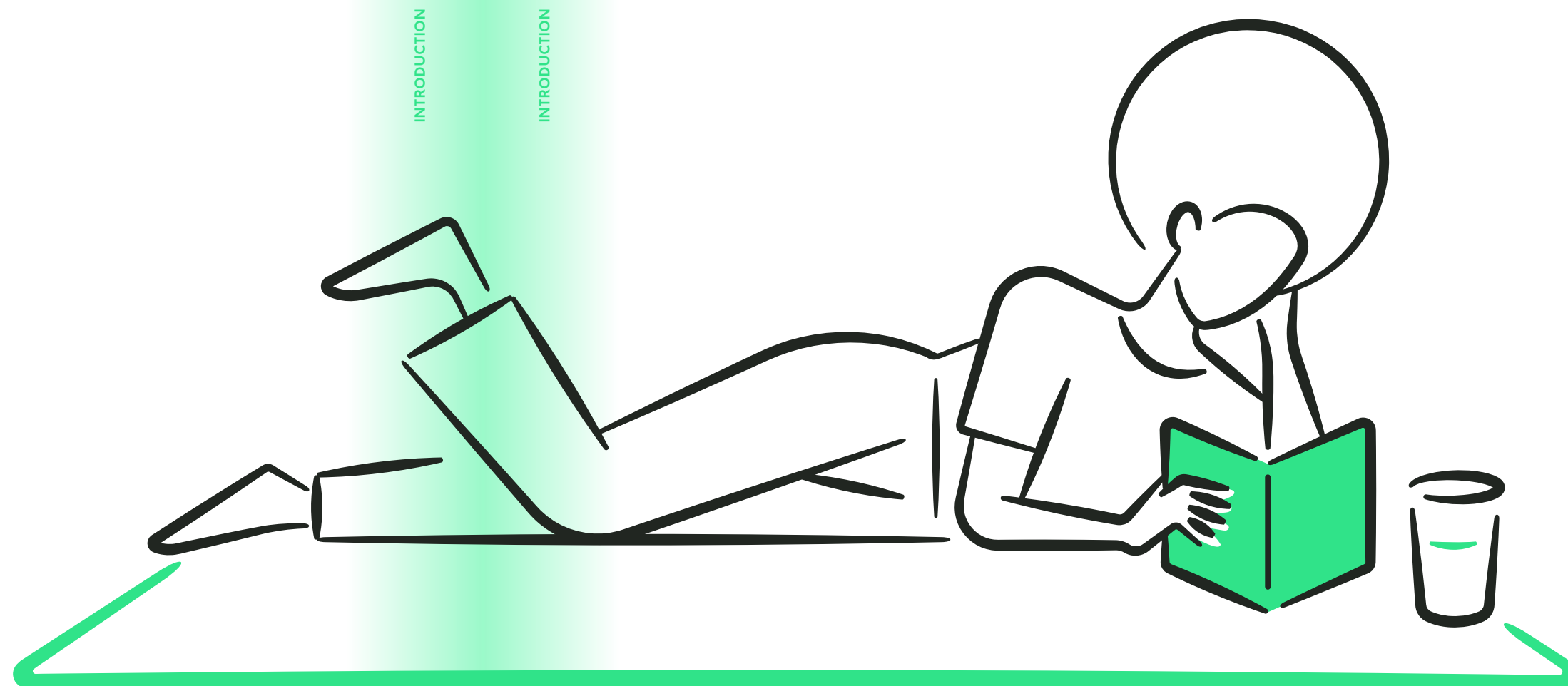

SMART COOKER™ FEATURES

1. COOKING POT

Your Smart Cooker™ must be used with a 6-quart pot insert. The nonstick one that comes with it includes handy measurements inscribed inside. Use nonstick-safe utensils when cooking and non-abrasive cleaners when cleaning to protect nonstick coating from damage.

2. CONTROL PANEL

Look here for cooking functions, on-unit screen instructions, scale, and more.

3. DIAL

Use the dial to navigate the on-unit screen of the Smart Cooker™. Turn the dial right or left to move the cursor on the screen and press the dial to make selections.

4. FLOATING VALVE

The red floating valve indicates whether the Smart Cooker™ is pressurized or not. As the Smart Cooker™ becomes pressurized, the valve will rise, sealing steam inside the pot. When the valve is raised, the Smart Cooker™ lid will lock and will only unlock after pressure is released. When the machine is off or another cooking method is being used, the valve remains flush with the lid.

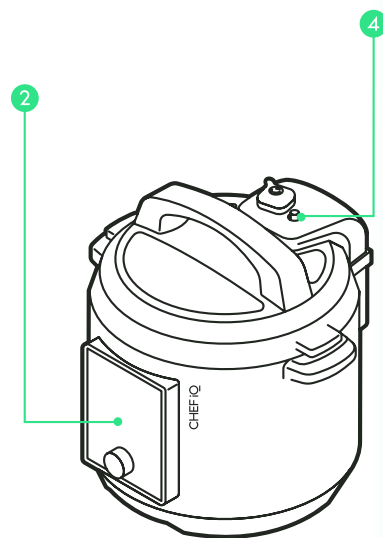
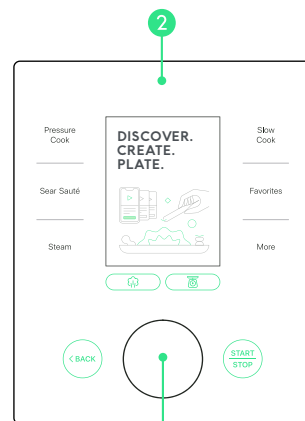
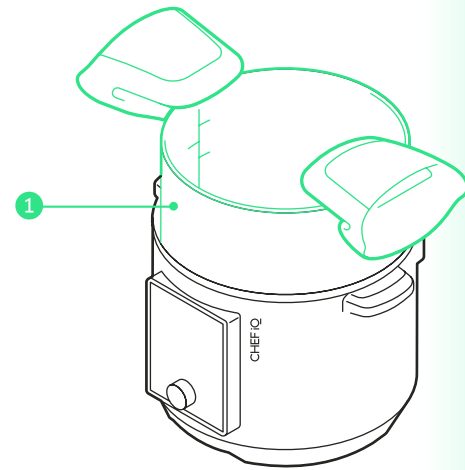

SMART COOKER™ FEATURES

SMART COOKER™ FEATURES

5. PRESSURE REGULATOR KNOB

Pressure (hot steam) is regulated and released via vents in the pressure regulator knob. When cooking with pressure, turn the knob to the “Sealed” position and keep face and hands away from the knob. For non-pressure functions like steam and slow cook, turn the pressure regulator knob to the “Venting” position before cooking.

NOTE: THE KNOB IS REMOVABLE; BE CAREFUL WHEN HANDLING THE LID AS IT CAN COME OFF.

WARNING: STEAM IS RELEASED FROM THE PRESSURE REGULATOR KNOB. DO NOT PUT HANDS, FACE, OR OTHER BODY PARTS OVER OR NEAR THE PRESSURE REGULATOR KNOB. STEAM IS HOT AND MAY CAUSE BURNS.

6. POWER CORD

The power cord is detachable. Plug the power cord into the Smart Cooker™ before plugging it into an outlet. When not in use, unplug the power cord from the outlet to protect against external power surges or other power fluctuations.

7. LID

It's essential that the lid be in place for certain cooking functions, most especially pressure cooking. To secure the lid, position the regulator knob over the condensation cup area at the back of the Smart Cooker™. Turn the handle clockwise until lid is secure. When properly aligned, the two wings on the lid will align with the two handles on the Smart Cooker™ unit and the arrow on the lid will align with the lock icon on the unit. When pressure cooking, the lid will lock once pressure is reached and will only unlock after pressure is released.

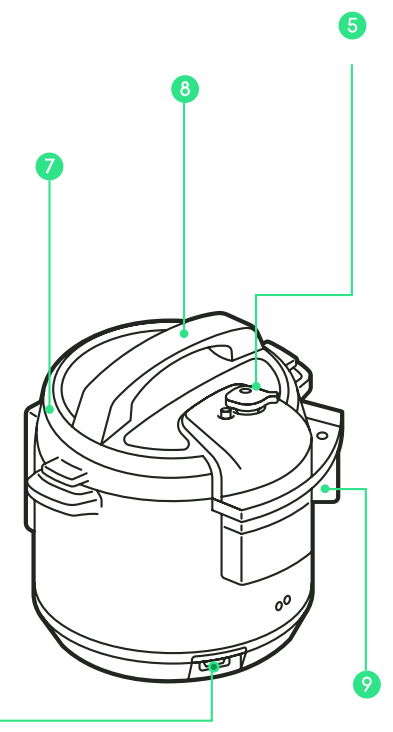

8. HANDLE

The large single handle on top of the lid makes the lid easy to maneuver. To close the lid, turn the handle clockwise. When the Smart Cooker™ is pressurized, the lid will be locked. Once pressure is released, turn the handle counterclockwise to open.

9. CONDENSATION CUP

The removable condensation cup collects liquids that collect in the grooved rim (the condensation ring) of the Smart Cooker™ and should be cleaned between uses.

10. GASKET

Also called a sealing ring, the flexible, silicone gasket fits into the underside of the Smart Cooker™ lid, keeping the steam inside in order to build pressure.

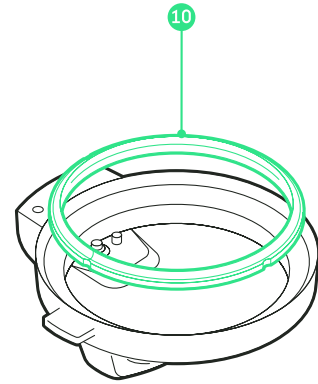

SMART COOKER™ FEATURES

SMART COOKER™ ACCESSORIES

SMART COOKER™ ACCESSORIES

Steam Rack

The steam rack is essential for steaming foods above liquid. Insert the steam rack into the cooking pot with its handles up to create a platform for large pieces of food like fish, chicken, and whole vegetables. It can also be used, with the handles facing down, as a platform for the steam basket.

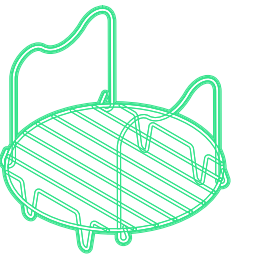

Steam Basket

Use the steam basket, paired with the steam rack, to steam small pieces of food, such as chopped vegetables and shellfish. Insert the steam rack into the cooking pot with its handle folded, then place the steam basket on the rack.

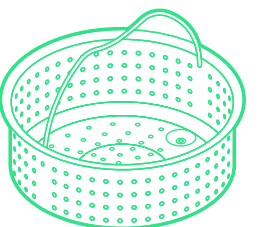

BEFORE FIRST USE

For best results, follow these steps before using your Smart Cooker™ for the first time:

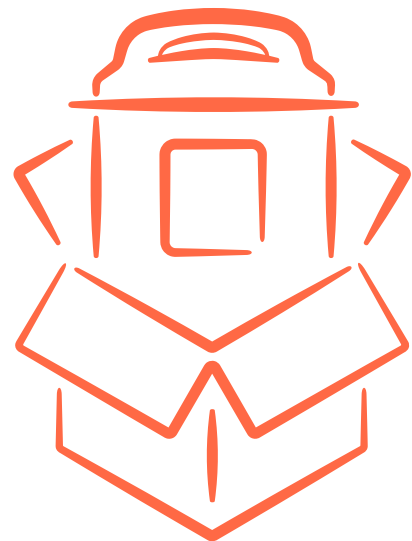

1. Remove all packaging materials, such as plastic bags and pulp inserts.
2. Read and remove stickers from the Smart Cooker™.
3. Check to ensure that all Smart Cooker™ parts are accounted for.
4. Wipe down the exterior of the Smart Cooker™ with a damp cloth.
5. Wash the cooking pot, gasket, accessories, and lid with warm, soapy water. Dry thoroughly.
6. Attach the power cord to the Smart Cooker™. Plug the power cord into an outlet.

SMART COOKER™ SAFETY GUIDE



IMPORTANT SAFEGUARDS:

When using electrical appliances, basic safety precautions should always be followed including the following:

1. Read all instructions.
2. Do NOT touch hot surfaces. Use handles or knobs.
3. To protect against electrical shock, do NOT immerse the power cord, plug, or housing in water and/or other liquids.
4. Close supervision is necessary when any appliance is used by or near children.
5. Unplug your Smart Cooker™ from the outlet when not in use and before cleaning. Let cool before putting on or taking off parts.
6. Do NOT use the Smart Cooker™ with a damaged power cord or plug.
7. Do NOT use your Smart Cooker™ if it malfunctions or has been damaged in any manner. In such cases, contact CHEFiQ® Customer Support.
8. The use of accessories not recommended by CHEFiQ® may cause injuries and/or damage to your Smart Cooker™.
9. Do NOT use outdoors.
10. Do NOT let power cord hang over edge of table or counter. Do NOT let power cord come into contact with hot surfaces.
11. Do NOT place your Smart Cooker™ on or near a hot gas or electric burner. Do NOT place your Smart Cooker™ in a heated oven.
12. Use extreme caution when moving any appliance containing hot oil and/or hot liquids.
13. Always attach the power cord to your Smart Cooker™, then plug the power cord into the wall outlet. To turn off your Smart Cooker™, remove the power cord from the wall outlet.
14. Do NOT use your Smart Cooker™ for anything other than its intended use.

SAVE THESE INSTRUCTIONS!

California Proposition 65:
(Applicable to California residents only.)



SHORT CORD INSTRUCTIONS:

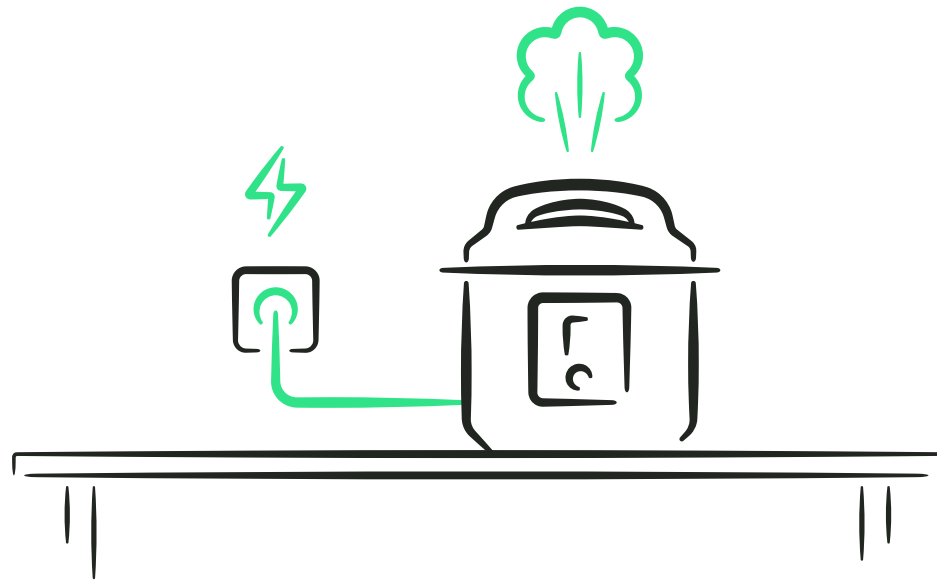

A short power supply cord is provided to reduce the hazards of entanglement or tripping over a longer cord. Longer detachable power-supply cords or extension cords are available and may be used if care is exercised in their use. If a longer detachable power-supply extension cord is used:

1. The marked electrical rating of the extension cord should be at least as great as the electrical rating of the appliance.
2. The cord should be arranged so that it will not drape over the countertop or tabletop where it can be pulled on by children or tripped over unintentionally.

POWER CORD SAFETY TIPS:

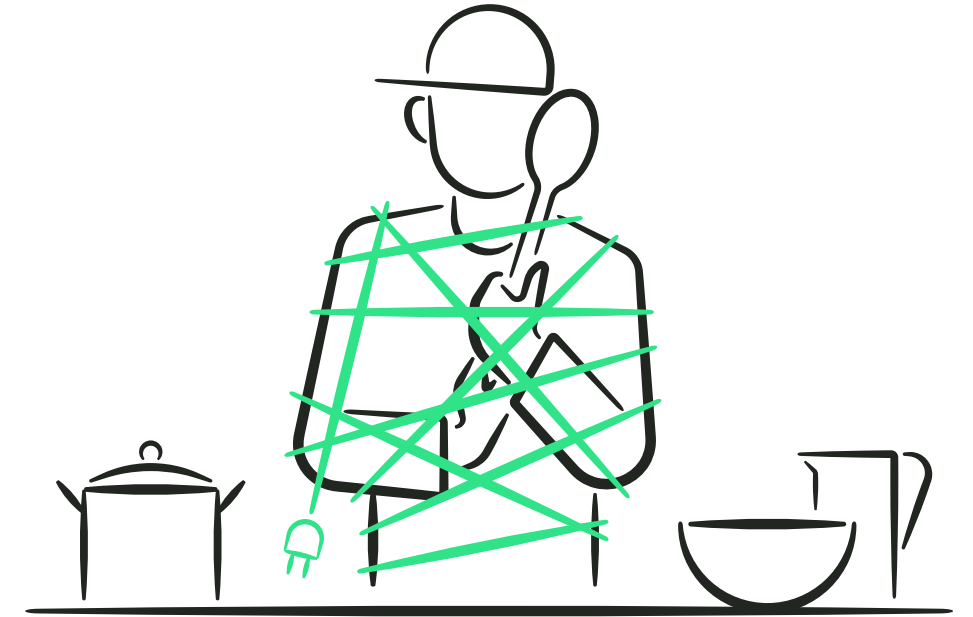

1. Never pull or yank on cord or the appliance.
2. To insert plug, grasp it firmly and guide it into outlet.
3. To disconnect appliance, grasp plug and remove it from outlet.
4. Before each use, inspect the power cord for cuts and/or abrasion marks. If any are found, this indicates that the appliance should be serviced, and the power cord replaced. Please contact CHEFiQ® Support for assistance.
5. Never wrap the cord tightly around the appliance, as this could place undue stress on the cord where it enters the appliance and cause it to fray and break.

DO NOT OPERATE APPLIANCE IF THE POWER CORD SHOWS ANY DAMAGE OR IF APPLIANCE WORKS INTERMITTENTLY OR STOPS WORKING ENTIRELY.

Do not place the appliance on a stovetop or any other heatable surface.

COOKING FUNCTIONS

The Smart Cooker™ offers myriad ways to cook your favorite foods. Most are displayed on, and selected from, the control panel; look for others by pressing [More](#) on the control panel:

COOKING FUNCTIONS

COOKING FUNCTIONS



PRESSURE COOK

WHAT IS PRESSURE COOKING?

Pressure cooking can seem miraculous. That's because it cooks food much faster and more deliciously than just about any other method all while using less energy. It works by cooking foods in a sealed environment that does not allow steam to escape below a pre-set pressure level. The trapped steam cooks foods at a higher temperature (around 250°F instead of 212°F) while the pressure forces the liquid into foods making them moist and flavorful. Pressure cooking turns tough cuts of meat fork tender in a matter of minutes (as opposed to the hours it usually takes) and cooks dried beans to silky perfection. But don't stop there: You can cook eggs, cheesecake, pasta, and more under pressure, and the Smart Cooker™ makes it safe, easy, and fun!

A few things to keep in mind when pressure cooking:

- A pressure cooker always requires some liquid for cooking; ½ cup is the minimum amount needed to pressure cook in the Smart Cooker™.
- The Smart Cooker™ offers two pressure levels — high and low. Most foods cook under high-pressure, which breaks them down quicker. Delicate foods sensitive to overcooking, such as rice and eggs, work best with low-pressure.
- When the correct pressure is reached, the lid of the Smart Cooker™ will lock in place. The lid will unlock only after pressure has been released.
- A pressure cooker recipe may start with a searing or sautéing step to help build flavor.
- When pressure cooking foods that foam, froth, or bubble, such as rice, pasta, and beans, fill the cooking pot halfway or less.
- When pressure cooking, add dairy products after pressure has been released because dairy curdles under pressure; however, you can use butter for sautéing foods before pressure cooking.



PRESSURE COOK

PRESSURE COOK

Pressure release options:

Pressure comes from steam contained within the Smart Cooker™. When cooking time ends, the Smart Cooker™ releases pressure (steam) in one of three ways:

QUICK

As its name implies, quick release expels a strong jet of steam very quickly. Recommended for most foods, quick release lowers the pressure fast, helping to avoid overcooking. The Smart Cooker™ issues an audible and visual 10-second warning countdown before steam is released.

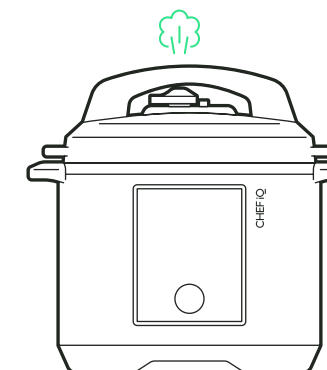

PULSE

Recommended for starchy foods like beans and pasta that can foam if steam is released too quickly, pulse expels jets of steam in spurts until all pressure has been released. The Smart Cooker™ issues an audible and visual 10-second warning countdown before steam is released.

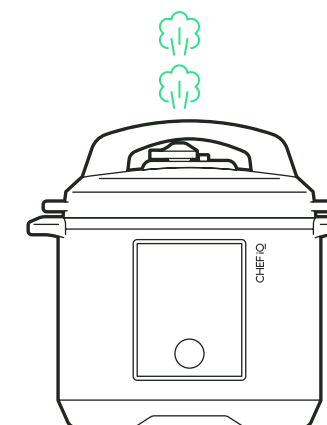

NATURAL

Recommended for foods unlikely to overcook, such as soups and stews, natural release lets steam escape slowly without any forceful expulsion. Natural release can take 15 minutes to 1 hour depending on the amount of food in the pot. During Natural Release, the screen may display "Food is Ready," but you'll not be able to unlock the lid until all the red pressure valve has dropped level with the lid.

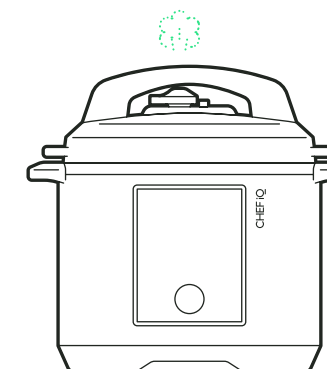

NOTE: YOU CAN RELEASE STEAM MANUALLY AT ANY TIME BY PRESSING AND HOLDING THE RELEASE BUTTON ON THE CONTROL PANEL.

WARNING: STEAM IS RELEASED FROM THE PRESSURE REGULATOR KNOB. DO NOT PUT HANDS, FACE, OR OTHER BODY PARTS OVER OR NEAR THE PRESSURE RELEASE KNOB. STEAM IS HOT AND MAY CAUSE BURNS.

HOW TO PRESSURE COOK IN THE SMART COOKER™

IMPORTANT: IF YOU'RE USING A CHEFiQ® GUIDED COOKING RECIPE FROM THE APP, THOSE DIRECTIONS INCLUDE COOKING PARAMETERS SENT DIRECTLY FROM THE APP TO YOUR SMART COOKER™ AND DO NOT REQUIRE ADDITIONAL MANUAL INPUT ON THE UNIT. TO EXECUTE THE GUIDED COOKING RECIPES, SIMPLY FOLLOW THE STEPS DISPLAYED IN THE RECIPE ON YOUR SMART DEVICE.

1. Ensure the cooking pot is clean and dry. Insert it into the Smart Cooker™.

2. Press Pressure Cook on the control panel; the Pressure Cook menu will display on the screen.

3. Use the dial to select Manual to cook with custom parameters or select a food category to receive suggested cooking parameters. (If selecting a food category, you'll be prompted to select details about the food you're cooking in order to determine the best time, pressure level, and release method for the food.)

4. Use the dial to adjust the Cook Time, Pressure Level, Keep Warm, Delay Start, and Pressure Release settings as desired. If using suggested cooking parameters, however, it's best to use the recommended settings.

NOTE: THE KEEP WARM SETTING WILL KEEP FOODS AT 165°F FOR UP TO 72 HOURS AFTER COOKING.

NOTE: DELAY START WILL NOT INITIATE COOKING UNTIL THE SET DELAY TIME HAS ENDED. PLEASE FOLLOW PROPER FOOD SAFETY GUIDELINES WHEN USING THIS FEATURE.

5. Select Continue to confirm the cooking parameters.

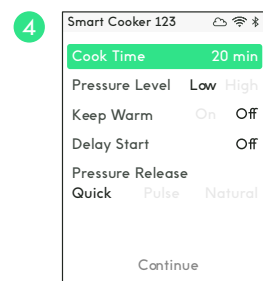
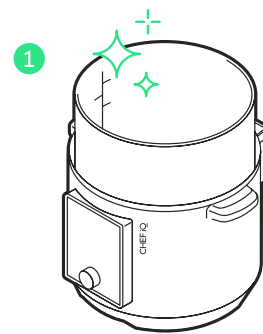

4
PRESSURE COOK

PRESSURE COOK

6. Place the food into the cooking pot no higher than the line marked MAX PC.

7. Follow the directions on the checklist displayed on the unit's screen, which include pressing the Start/Stop button on the control panel to start cooking. (If Delay Start was selected, the Smart Cooker™ will begin the countdown to the start time. If not, cooking will begin, and pressure will start to build.)

NOTE: THE LID MUST REMAIN ON IN ORDER FOR PRESSURE TO BUILD; A MELODY WILL SOUND IF YOU OPEN THE LID WHILE THE SMART COOKER™ IS BUILDING PRESSURE.

8. Once the set pressure level is reached, the red floating valve will be fully risen, the lid locked, and the Cook Time will begin to count down.

NOTE: YOU CAN CANCEL OUT OF COOKING AT ANY TIME BY PRESSING THE START/STOP BUTTON.

9. When the Cook Time ends, pressure will release automatically in one of three ways (Quick, Pulse, or Natural), depending on what was set. To manually release pressure, press and hold Release on the control panel.

10. If the Keep Warm function was selected, it will begin after pressure cooking ends. Press Start/Stop to exit out of Keep Warm and return to the main menu.

11. If Keep Warm was not set, press the Dial to return to the main menu.

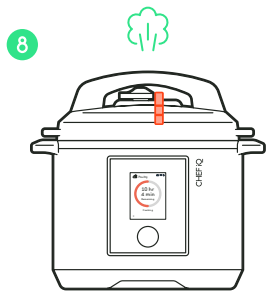
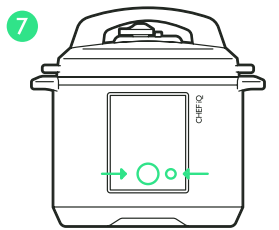
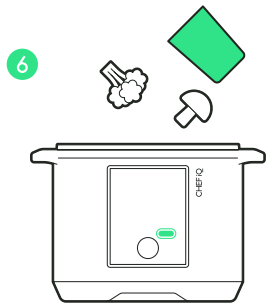

SEAR/SAUTÉ

With the Sear/Sauté function, you can use your Smart Cooker™ like you would use a skillet or sauté pan on the stove.



SEAR/SAUTÉ

SEAR/SAUTÉ



WHAT IS SEARING AND SAUTÉING?

Searing and sautéing are similar cooking methods in that both use direct, dry heat and cook uncovered. Searing exposes the surface of foods to steady high heat with the goal of browning the exterior to develop and deepen flavor. With searing, the food is often not cooked through at this stage; rather the sear develops a flavorful crust on the food before it's finished with lower or moist heat. When searing, the Smart Cooker™ sets the temperature to very high.

Sautéing also involves cooking with direct, dry heat but the food, usually smaller pieces, is moved around in the pan as it cooks. (Sauté in French means to jump.) When sautéing, the Smart Cooker™ allows you to adjust the temperature to low, medium, and high.

NOTE: FOR BOTH SAUTÉING AND SEARING, YOU'LL GET THE BEST BROWNING AND MOST FLAVOR IF YOU SEAR OR SAUTÉ IN A LITTLE OIL OR BUTTER.

HOW TO SEAR/SAUTÉ IN THE SMART COOKER™

IMPORTANT: IF YOU'RE USING A CHEFiQ® GUIDED COOKING RECIPE FROM THE APP, THOSE DIRECTIONS INCLUDE COOKING PARAMETERS SENT DIRECTLY FROM THE APP TO YOUR SMART COOKER™ AND DO NOT REQUIRE ADDITIONAL INPUT ON THE UNIT. TO EXECUTE THE GUIDED COOKING RECIPES, SIMPLY FOLLOW THE STEPS DISPLAYED IN THE RECIPE ON YOUR SMART DEVICE.

1. Ensure the cooking pot is clean and dry. Insert it into the Smart Cooker™.

2. Press Sear/Sauté on the control panel; the Sear/Sauté menu will display on the screen.

3. Select Manual to cook with custom parameters or select a food category to receive suggested cooking parameters. (If selecting a food category, you'll be prompted to select details about the food you are cooking in order to determine the best time and temperature for the food.)

4. Use the dial to adjust the Cook Time, Temperature and Keep Warm settings as desired. If using suggested cooking parameters, however, it's best to use the recommended settings.

NOTE: THE KEEP WARM SETTING WILL KEEP FOODS AT 165°F FOR UP TO 72 HOURS AFTER COOKING.

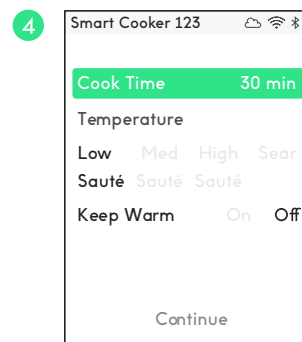
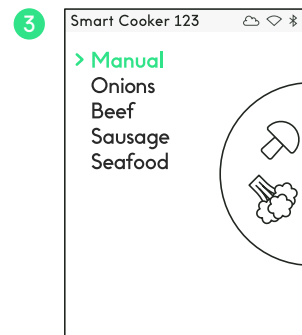
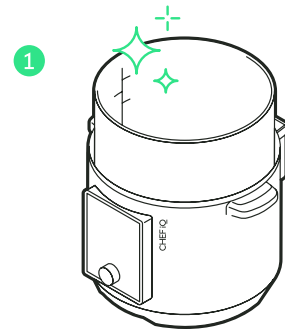

SEAR/SAUTÉ

SEAR/SAUTÉ

5. Select Continue to confirm the cooking parameters.

6. Place the food into the cooking pot no higher than the line marked MAX PC.

7. Follow the directions on the checklist displayed on the unit's screen, which include pressing the Start/Stop button on the control panel to start cooking.

8. Cooking will start and the Cook Time will begin. To adjust the Cook Time or Temperature while cooking, use the dial to select Change Time/Temp and adjust to desired time and temperature. Use the dial to go back to the cooking screen.

NOTE: YOU CAN CANCEL OUT OF COOKING AT ANY TIME BY PRESSING THE START/STOP BUTTON.

9. The Keep Warm function (when selected) will begin after cooking ends. Press Start/Stop to exit out of Keep Warm and return to the main menu.

10. If Keep Warm was not set, press the Dial to return to the main menu.

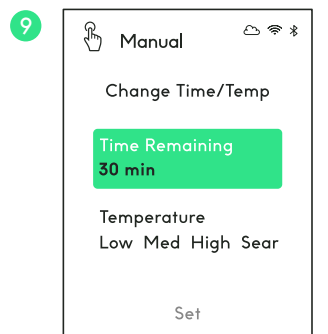
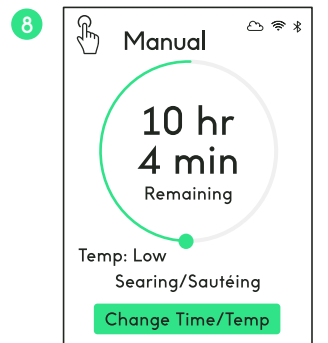

STEAM

WHAT IS STEAMING?

Steaming usually involves placing foods above simmering water; the vaporizing liquid conducts heat to the food to gently cook it. When steaming in the Smart Cooker™, the food sits on either the steam rack or in the steam basket set above the steaming water. Steaming cooks foods gently, making it perfect for vegetables and seafood. It requires no additional fats, and foods usually retain their shape and their nutrients.

HOW TO STEAM IN THE SMART COOKER™

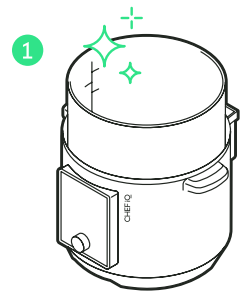

IMPORTANT: IF YOU'RE USING A CHEF:Q® GUIDED COOKING RECIPE FROM THE APP, THOSE DIRECTIONS INCLUDE COOKING PARAMETERS SENT DIRECTLY FROM THE APP TO YOUR SMART COOKER™ AND DO NOT REQUIRE ADDITIONAL INPUT ON THE UNIT. TO EXECUTE THE GUIDED COOKING RECIPES, SIMPLY FOLLOW THE STEPS DISPLAYED IN THE RECIPE ON YOUR SMART DEVICE.

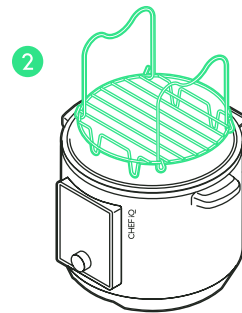

1. Ensure the cooking pot is clean and dry. Insert it into the Smart Cooker™.

2. Place food on steam rack or in steam basket. (Alternatively add food after steam rack or basket has been inserted into cooking pot.)

NOTE: STEAM BASKET MUST BE USED WITH STEAM RACK; INSERT RACK FIRST.

3. Press Steam on the control panel; the Steam menu will display on the screen.



STEAM

STEAM

4. Select Manual to cook with custom parameters or select a food category to receive suggested cooking parameters. (If selecting a food category, you'll be prompted to select specific details about the food you're cooking in order to determine the best time for the food.)

5. Use the dial to adjust the Cook Time, Keep Warm and Delay Start settings as desired.

NOTE: THE KEEP WARM SETTING WILL KEEP FOODS AT 165°F FOR UP TO 72 HOURS AFTER COOKING.

NOTE: DELAY START WILL ALLOW YOU TO PUT CONTENTS INTO THE COOKING POT BUT WILL NOT INITIATE COOKING UNTIL THE SET DELAY TIME HAS ENDED. PLEASE FOLLOW PROPER FOOD SAFETY GUIDELINES WHEN USING THIS FEATURE.

6. Press Continue when finished.

7. Follow the directions on the checklist displayed on the unit's screen, adding your food along with the rack or basket, which include pressing the Start/Stop button on the control panel to start cooking.

8. If Delay Start was selected, the Smart Cooker™ will countdown to cooking. If not, cooking will start, and the Cook Time will begin to count down.

9. To adjust the Cook Time while cooking, use the dial to select Change Time and adjust to desired time. Use the dial to go back to the cooking screen.

NOTE: YOU CAN CANCEL OUT OF COOKING AT ANY TIME BY PRESSING THE START/STOP BUTTON.

10. The Keep Warm function (when selected) will begin after cooking ends. Press Start/Stop to exit out of Keep Warm and return to the main menu.

11. If Keep Warm was not set, press the Dial to return to the main menu.

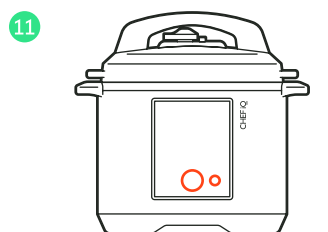
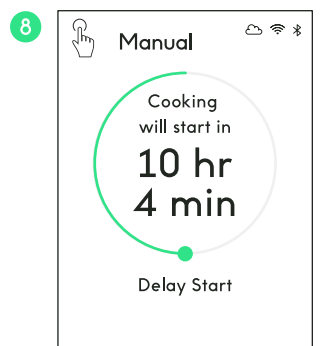
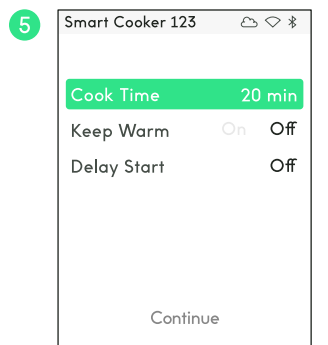
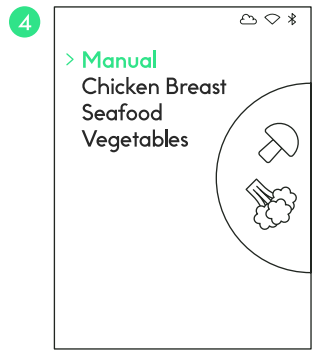

SLOW COOK

With its ample, 6-quart cooking pot and its Delay Start and Keep Warm functions, the Smart Cooker™ makes an excellent slow cooker. Plus, foods to be slow cooked can be seared before slow cooking right in the Smart Cooker™ cooking pot, which not only boosts the flavor of the final dish, but also means one less pot to clean.



SLOW COOK

SLOW COOK

WHAT IS SLOW COOKING?

Slow cooking is exactly what it sounds like: slowly cooking foods with low, steady, moist heat, usually in a covered pot and over a long period of time, typically 4 hours or more. The resulting slow-cooked foods become tender and flavorful. Slow cooking is not pressurized and generally comes with low and high temperature settings, which affect the total cooking time. High temperature generally cooks a dish in 4-6 hours, while low generally takes 8-10 hours to reach the same result.

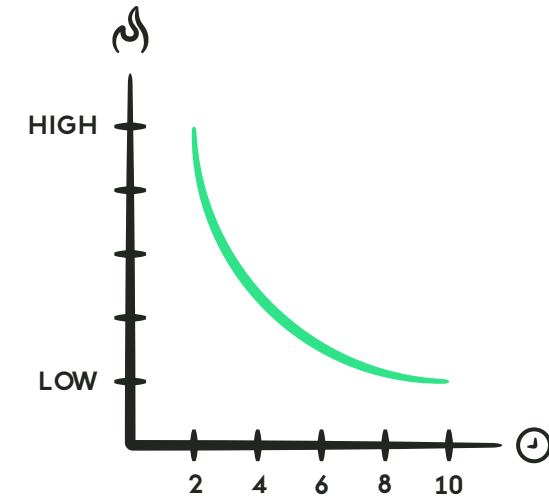

HOW TO SLOW COOK IN THE SMART COOKER™

IMPORTANT: IF YOU'RE USING A CHEFiQ® GUIDED COOKING RECIPE FROM THE APP, THOSE DIRECTIONS INCLUDE COOKING PARAMETERS SENT DIRECTLY FROM THE APP TO YOUR SMART COOKER™ AND DO NOT REQUIRE ADDITIONAL INPUT ON THE UNIT. TO EXECUTE THE GUIDED COOKING RECIPES, SIMPLY FOLLOW THE STEPS DISPLAYED IN THE RECIPE ON YOUR SMART DEVICE.

1. Ensure the cooking pot is clean and dry. Insert it into the Smart Cooker™.

2. Press Slow Cook on the unit's control panel. The Slow Cook menu will display on the unit's screen.

3. Select Manual to cook with custom parameters or select a food category to receive suggested cooking parameters. (If selecting a food category, you'll be prompted to select specific details about the food you are cooking in order to determine the best time or temperature for the food.)

4. Use the dial to adjust the Cook Time, Temperature, Keep Warm and Delay Start settings (if desired). If using suggested cooking parameters, however, it's best to use the recommended settings.

NOTE: THE KEEP WARM SETTING WILL KEEP FOODS AT 165°F FOR UP TO 72 HOURS AFTER COOKING.

NOTE: DELAY START WILL ALLOW YOU TO PUT CONTENTS INTO THE COOKING POT BUT WILL NOT INITIATE COOKING UNTIL THE SET DELAY TIME HAS ENDED. PLEASE FOLLOW PROPER FOOD SAFETY GUIDELINES WHEN USING THIS FEATURE.

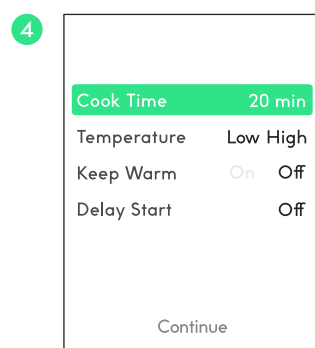
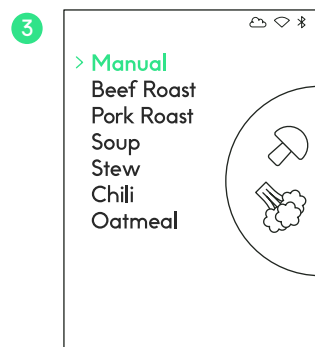
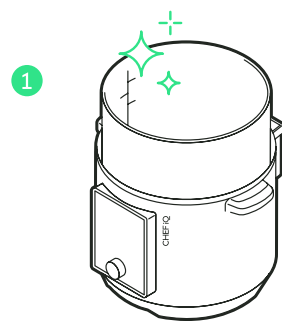

SLOW COOK

SLOW COOK

5. Press Continue when finished.

6. Insert the food into the cooking pot (do not fill past the MAX line).

7. Follow the directions on the checklist displayed on the unit's screen, which include pressing the Start/Stop button on the control panel to start cooking.

8. If Delay Start was selected, the Smart Cooker™ will countdown to cooking. If not, cooking will start, and the Cook Time will begin to count down. To adjust the Cook Time or Temperature while cooking, use the dial to select "Change Time/Temp" and adjust to desired time and temperature. Use the dial to go back to the cooking screen.

NOTE: YOU CAN CANCEL OUT OF COOKING AT ANY TIME BY PRESSING THE START/STOP BUTTON.

9. The Keep Warm function (when selected) will begin after cooking ends. Press the Start/Stop button to exit out of Keep Warm and return to the main menu.

10. If Keep Warm was not set, press the Dial to return to the main menu.

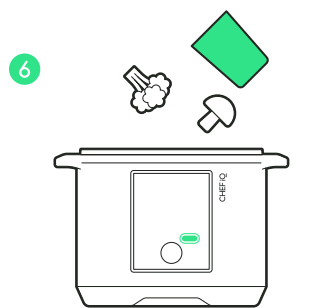

SCALE

Most professional chefs use weight rather than volume to measure ingredients because it's more accurate. The Smart Cooker™ comes with an integrated scale, which means you can easily measure ingredients by weight as you add them to the cooking pot. Not only is measuring by weight easy and efficient, it also means there are no measuring cups or spoons to clean!

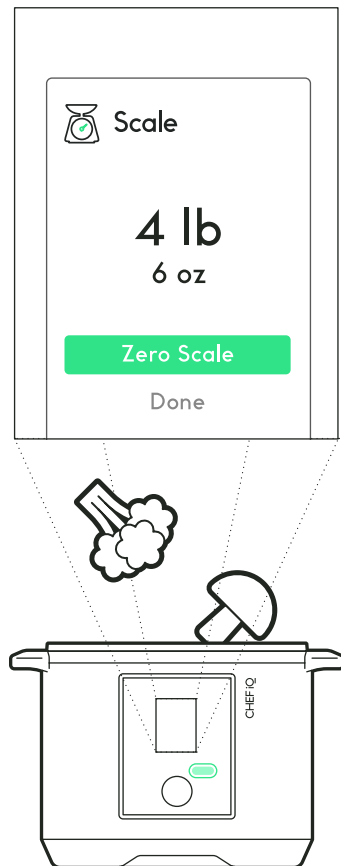

HOW TO USE THE SMART COOKER™ SCALE

1. Before using the scale, set the desired measuring unit by going to Settings, which you can access by pressing More on the control panel. Under Weight Units, displayed on the unit's screen, choose either ounces or grams.

2. Ensure the cooking pot is clean and dry. Insert it into the Smart Cooker™. Add steam rack, basket, or other cooking vessel if using.

3. Press the Scale button on the control panel.

4. Use the control panel dial to select Zero Scale.

5. Add ingredient to the cooking pot, stopping when you have reached desired weight.

6. To add the next ingredient by weight, reset scale to 0. Continue adding and resetting scale as need to weigh all ingredients needed up to this point in the recipe. When finished weighing at this time in the cooking process, press Done.

7. You can add additional ingredients by weight after cooking has started (unless the unit has built pressure, in which case the lid is locked) by pressing Scale again. Reset to scale to 0 and add ingredient(s), resetting to 0 between each ingredient as needed.

WARNING: IF ADDING INGREDIENTS DURING COOKING, POT AND CONTENTS WILL BE HOT.

NOTE: THE SCALE IS VERY SENSITIVE. MOVING THE UNIT OR THE CORD WHILE USING THE SCALE MAY AFFECT RESULTS.

SCALE

SCALE

FAVORITES

When using the CHEF*iQ*® app, you can use the handy cooking calculator for discovering the best cooking parameters for cooking your favorite foods. You can then relay them right to the Smart Cooker™; to use these customized pre-sets, press Favorites on the control panel.

NOTE: YOU CAN ALSO TWEAK THE PARAMETERS AS YOU LIKE BEFORE SAVING THEM AS FAVORITES.

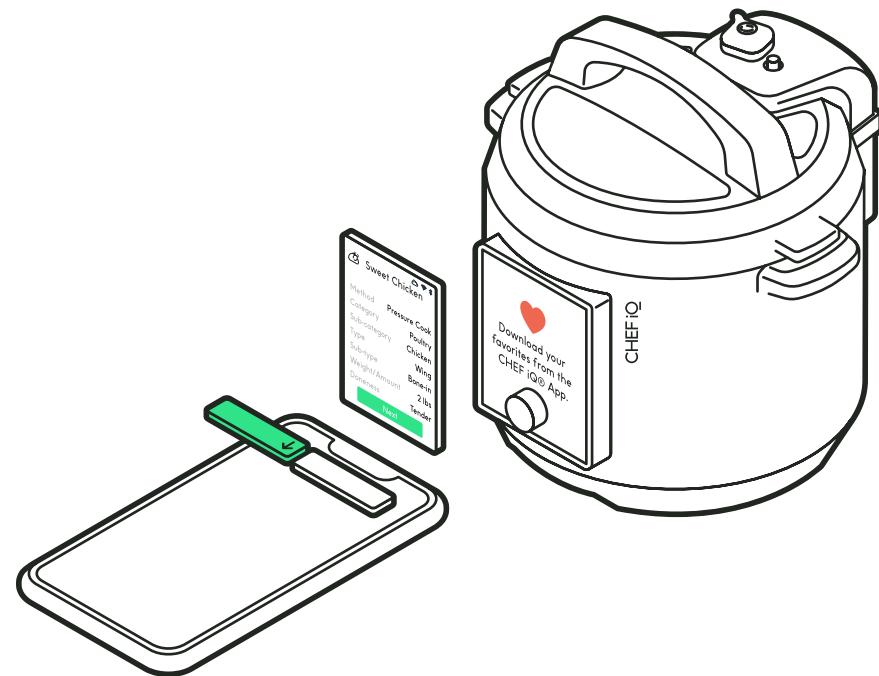

FAVORITES

MORE

Look for additional cooking functions as well as general settings under More on the control panel.



MORE

FERMENT

WHAT IS FERMENTING?

Fermenting is an age-old way of preserving foods by transforming them through exposure to healthy bacteria naturally or through inoculation. Fermentation continues today because it develops flavors and introduces additional health benefits. Different kinds of fermentation produce such disparate and delicious foods as olives, cheese, beer, yogurt, miso, bread, and wine. The Ferment function on the Smart Cooker™ holds the temperature inside the cooking pot to 110°F, the optimum temperature for fermenting yogurt. For best results, follow the cooking guidelines from a trusted recipe when using the Ferment function.

WARNING: WHEN USING THE FERMENT FUNCTION, FOLLOW PROPER FOOD HANDLING SAFETY GUIDELINES.



KEEP WARM

The Keep Warm function keeps foods at 165°F, a food-safe temperature, for up to 72 hours after they've been cooked. While this function can be set to occur automatically when programming the Smart Cooker™ for other functions, it can also be set manually from this menu, and can even keep food not cooked in the Smart Cooker™ warm. Follow proper food safety guidelines when using the Keep Warm function.

HOW TO SET KEEP WARM MANUALLY:

1. Insert the cooking pot into the Smart Cooker™.
2. Press More on the control panel. Select Keep Warm.
3. Use the dial to adjust Time in 30-minute increments as desired.
4. Add cooked foods to the cooking pot if not in there already. Close the lid and set the regulator knob to “Venting.”
5. Press Start/Stop on the control panel to start Keep Warm.
6. Warming will begin.
7. To adjust the time while warming, use the dial to select Change Time and adjust to desired time, then select Set. When the time ends, the unit will cease heating and go into sleep mode.

NOTE: YOU CAN CANCEL OUT OF WARMING AT ANY TIME BY PRESSING THE START/STOP BUTTON.



MORE

SANITIZE



With its high-temperature, pressurized steam can be used to clean. It is advisable to hand-wash items prior to steam cleaning.

HOW TO SANITIZE:

1. Ensure the cooking pot is clean and dry. Insert it into the Smart Cooker™.
2. Insert steam rack.
3. Add 1 ½ to 2 cups water to pot.
4. Place items to clean on steam rack.
5. Press More on the control panel. Select Sanitize.
6. Follow the directions on the checklist displayed on the unit's screen, which include pressing Start/Stop on the control panel.
7. When the Time ends, press the Dial to return to the main menu.

NOTE: YOU CAN RELEASE STEAM MANUALLY AT ANY TIME BY PRESSING THE RELEASE KEY ON THE CONTROL PANEL.

WARNING: STEAM IS RELEASED FROM THE PRESSURE REGULATOR KNOB. DO NOT PUT HANDS, FACE, OR OTHER BODY PARTS OVER OR NEAR THE PRESSURE RELEASE KNOB. STEAM IS HOT AND MAY CAUSE BURNS.

MORE

SETTINGS

Settings includes the following options:

WIFI CONNECTION

Use the dial to adjust between enabling and disabling WiFi connectivity.

WEIGHT UNITS

Use the dial to adjust the scale setting between ounces and grams.

SCREEN BRIGHTNESS

Use the dial to adjust brightness level. Press “Back” on unit to set.

GENERAL SETTINGS

General Settings includes the following:

ABOUT SMART COOKER™

Offer technical information including model number and firmware version.

FIRMWARE UPDATE

Lets you know if your firmware is up to date and directs how to update it if necessary.

WIFI RESET

Resets wireless connection. If reset, the Smart Cooker™ will no longer be paired.

FACTORY RESET

Resets Smart Cooker™ to factory setting, deleting all favorites and wireless connection.

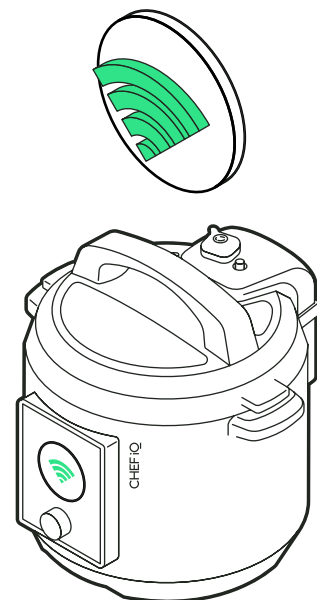

SETTINGS

CLEANING AND MAINTENANCE



CLEANING AND MAINTENANCE

1. Clean Smart Cooker™ cooking pot, accessories, and parts after every use.
2. Unplug the Smart Cooker™ and let cool to room temperature before cleaning.
3. After each use, remove the gasket from the underside of the lid. Wash the gasket with warm, soapy water and dry the with a soft cloth or wash in the top rack of the dishwasher
4. The lid, gasket, and all accessories are top-rack dishwasher safe.
5. Clean the condensation ring (the grooved channel on the unit) with a soft cloth after each use.
6. Always reposition the gasket properly on the underside of the lid before cooking. (See the [How-To video](#) on the app on correctly placing the gasket back into the lid.)
7. Clean the outside of the Smart Cooker™ with a damp soft cloth or sponge.
8. Never use harsh chemical detergents, scouring pads, or powders on any of the parts or components of the Smart Cooker™.
9. Periodically check that the valves on the underside of the lid are free of food particles. If dirty, gently wipe with a damp towel.
10. Never immerse the Smart Cooker™ and/or power cord in water or any other liquid.
11. Dry thoroughly before storing.

SMART COOKER™ FAQs

Why won't the lid close?

The lid will not close if it's not in correct position or if the gasket (sealing ring) is not properly secured to the Smart Cooker™ lid. (See CHEFiQ® app for video instructions on correctly placing the gasket back into the lid.) Check the gasket, then realign the lid.

Why is the red floating valve stuck in the popped-up position?

Occasionally trapped food particles can prevent the valve from lowering. Release the pressure manually by pressing Release on the control panel. Then, once cooled, check the underside of the lid for stuck-on food, and wipe clean with a damp cloth.

Why is steam coming from the rim of the lid during pressure cooking?

The gasket may have food stuck to it or be torn or damaged. Check that the gasket is clean and in place, or if it needs to be replaced. If it is damaged, contact CHEFiQ® Support.

Why is steam continuously coming out of the floating valve?

The pressure regulator knob may not be in the "Sealed" position. Ensure that the pressure regulator knob is in the "Sealed" position and that the lid is fully closed. As pressure builds, some steam will escape through the red floating valve.

Why is the red floating valve not rising?

There is not enough water or liquid to build pressure. Add more water or liquid. As a rule, use at least ½ cup of water when pressure cooking.

Why is the appliance's screen blank after plugging the appliance in?

The cord may not be fully attached to the unit. There may be a bad power connection, no power, or the appliance's fuse may have blown. Try a different power outlet to determine whether the outlet or appliance is causing the power issue. If the issue is the Smart Cooker™, unplug it and contact CHEFiQ® Support.

For more information about the Smart Cooker™ and CHEFiQ®, visit

CHEFiQ® WARRANTY

All CHEFiQ® products are backed by a limited 1-year warranty.

Service centers and retail stores do not have the right to alter or change the Terms & Conditions of this warranty.

WHAT THE WARRANTY COVERS:

CHEFiQ® products are warranted against defects in material and workmanship for a period of 1 year from the date of purchase, when used in accordance with the CHEFiQ® User Guide. This warranty requires a proof of purchase made within the USA, Canada, or Mexico*. If the product is damaged, does not work as it should, or is no longer available, a replacement product of equal or lesser value will be sent at the discretion of CHEFiQ® Support Team. We reserve sole discretion whether to require you to return the purchased product to us prior to shipping you a replacement.

THIS WARRANTY DOES NOT COVER:

• Misuse:

Damage that occurs from neglectful or improper use of products; damage that occurs as a result of usage with incompatible voltage. See Safety Instructions for information on proper use.

• Poor Maintenance:

General lack of proper care. See Cleaning and Maintenance Instructions for information on proper maintenance.

• Commercial Use:

Damage that occurs from commercial use.

• Altered Products:

Damage that occurs from alterations or modifications by any entity other than CHEFiQ®, removal of rating label.

• Catastrophic Events:

Damage that occurs from fire, floods or natural disasters.

• Loss of Interest:

Claims of loss of interest or enjoyment.

*By connecting the CHEFiQ® product to the CHEFiQ® app, the 1-year + 3 months warranty will activate. This connection will serve as a proof of purchase. In such cases where there is no connection, CHEFiQ® requires a proof of purchase to include receipt, order confirmation, etc. at the discretion of the CHEFiQ® Support Team.

FAQ

WARRANTY

EXTENDED WARRANTY:

Once your CHEFiQ® appliance is connected and paired to the CHEFiQ® app, the extended warranty will be enacted.

Want to know more?

Please visit us at [www.rjbrands.com](#) for additional information.

OTHER LIMITATIONS:

All warranties of any kind whatsoever, express, implied and statutory, are hereby disclaimed. All implied warranties of merchantability and fitness for a particular purpose are hereby disclaimed, provided that if any implied warranties of any kind is required by any jurisdiction, including merchantability and fitness for a particular purpose, the duration of such imposed implied warranty is limited to one (1) year. This warranty does not cover, and CHEFiQ® shall not be liable for, incidental, indirect, special or consequential damages, including without limitation, damage to, or loss of use of the product, or lost sales or profits or delay or failure to preform this warranty obligation. The remedies provided herein are the exclusive remedies under this warranty, whether based on contract, tort or otherwise.

This Warranty gives you specific legal rights, and you may also have other rights that vary from state to state or province to province. Some states or provinces do not allow the exclusions or limitations set forth in this Warranty, so the above limitations or exclusions may not apply to you depending on the jurisdiction of purchase.

CHEFiQ® is a registered trademark of RJ BRANDS, LLC.



FCC STATEMENT

WARRANTY

FCC STATEMENT

NOTE:

This equipment has been tested and found to comply with the limits for a Class B digital device, pursuant to part 15 of the FCC Rules. These limits are designed to provide reasonable protection against harmful interference in a residential installation. This equipment generates, uses and can radiate radio frequency energy and, if not installed and used in accordance with the instructions, may cause harmful interference to radio communications. However, there is no guarantee that interference will not occur in a particular installation. If this equipment does cause harmful interference to radio or television reception, which can be determined by turning the equipment off and on, the user is encouraged to try to correct the interference by one or more of the following measures:

- Reorient or relocate the receiving antenna.
- Increase the separation between the equipment and receiver.
- Connect the equipment into an outlet on a circuit different from that to which the receiver is connected.
- Consult the dealer or an experienced radio/TV technician for help.