

Rinnai Continuous Flow Water Heater

Infinity | 26
touch

Operation & Installation Manual

To Suit Water Heater Models

INFINITY 26 TOUCH • REU-VRM2626WD

This appliance shall be installed in accordance with:

- Manufacturer's Installation Instructions
- Current AS/NZS 5601 AS/NZS 3000 & AS/NZS 3500
- Local Regulations and Municipal Building Codes including local OH&S requirements

This appliance must be installed, maintained and removed by an Authorised Person.

For continued safety of this appliance it must be installed and maintained in accordance with the manufacturers instructions.



This Appliance complies
with AS 3498:2009
SAI GLOBAL LIC. W208



N10378



The Australian
Gas Association
All Rinnai gas products
are A.G.A. certified.

Rinnai

Relax. It's a Rinnai.



Rinnai

Infinity 26

This page is intentionally blank

OPERATION MANUAL

REGULATORY INFORMATION	4
WARNING ABOUT HOT WATER	4
FEATURES AND BENEFITS	5
IMPORTANT INFORMATION	6
OPERATION WITHOUT CONTROLLERS	8
GENERAL WATER CONTROL INFORMATION	9
RADIO COMMUNICATIONS	9
WATER RESISTANCE	9
MAXIMUM DELIVERY TEMPERATURES.....	9
WIRELESS WATER CONTROLLERS	11
ABOUT THE WIRELESS WATER CONTROLLER (MC-503RC)	11
TURNING ON THE WATER HEATER.....	11
ADJUSTING TEMPERATURE.....	11
TRANSFERRING PRIORITY BETWEEN WATER CONTROLLERS	12
USING CHILD LOCK FUNCTION.....	12
WIRELESS WATER CONTROLLERS BATTERIES.....	13
WIRELESS SMARTSTART PRE-HEAT OPERATION	14
ABOUT THE SMARTSTART® PRE-HEAT SYSTEM.....	14
UNIVERSAL WATER CONTROLLERS	15
ABOUT THE UNIVERSAL WATER CONTROLLER (MC-91Q).....	15
TURNING ON THE WATER CONTROLLER.....	15
ADJUSTING TEMPERATURE.....	15
HOW TO USE TWO OR MORE UNIVERSAL WATER CONTROLLERS	16
TRANSFERRING PRIORITY	16
ADJUSTING TEMPERATURE.....	16
DELUXE BATHROOM WATER CONTROLLERS	17
ABOUT THE DELUXE BATHROOM WATER CONTROLLER (BC-100V)	17
TURNING ON THE WATER CONTROLLER.....	17
SETTING THE SOUND OPTIONS	18
SETTING THE CLOCK	18
ADJUSTING TEMPERATURE.....	18
OPERATING THE SHOWER SAVER / BATH FILL FUNCTION	19
USING MULTIPLE WATER CONTROLLERS	20
COMBINING UNIVERSAL AND DELUXE WATER CONTROLLERS	20
DELUXE KITCHEN WATER CONTROLLERS	21
ABOUT THE DELUXE KITCHEN WATER CONTROLLER (MC-100V)	21
TURNING ON THE WATER CONTROLLER.....	21
SETTING THE SOUND OPTIONS	21
SETTING THE CLOCK	22
ADJUSTING TEMPERATURE.....	22
WIRED SMARTSTART PRE-HEAT OPERATION	23
ABOUT THE SMARTSTART® PREHEAT SYSTEM.....	23
TROUBLESHOOTING	24
ERROR CODES.....	24
SERVICE.....	24
INSTALLATION MANUAL	27
ACCESSORIES	42
PRODUCT RECORDS	42
CONTACT INFORMATION	44

REGULATORY INFORMATION

Your Rinnai Continuous Flow water heater has been certified by the Australian Gas Association. The A.G.A. Certification Number is shown on the data plate.

This Appliance must be installed correctly by an authorised person. The installation of gas, water, and electricity must conform to local regulations.

The installation must also comply with the instructions supplied by Rinnai.

All dimensions referred to in these instructions are in millimetres, unless otherwise specified.

Please keep this instruction booklet in a safe place for future reference.

Notice to Victorian Consumers

This appliance must be installed by a person licensed with the Plumbing Industry Commission.

Only a licensed person will have insurance protecting their workmanship.

So make sure you use a licensed person to install this appliance and ask for your Compliance Certificate. For Further information contact the Plumbing Industry Commission on 1800 015 129.

WARNING ABOUT HOT WATER



Heated water can be dangerous, especially for young children and the infirm.

Water temperatures above 50°C can cause severe burns instantly and may even result in death.

Those most at risk are children, disabled, elderly and the infirm.

Hot water at 65°C (a very common hot water temperature in Australia) can severely burn a child in less than half a second. At 50°C it takes five minutes.

ALWAYS.....

Test the temperature of the water with your elbow before placing your child in the bath, also carefully feel water before bathing or showering yourself.

Supervise children whenever they are in the bathroom.

Make sure that the hot water tap is turned off tightly.

CONSIDER.....

Installing child proof tap covers or child resistant taps (both approaches will prevent a small hand being able to turn on the tap).

Setting your appliance at a maximum temperature of 50°C (Contact Rinnai Australia).

NEVER.....

Leave a toddler in the care of another child. They may not understand the need to have the water temperature set at a safe level.

FEATURES AND BENEFITS

Congratulations on purchasing the latest technology temperature controlled Rinnai continuous flow water heating system.

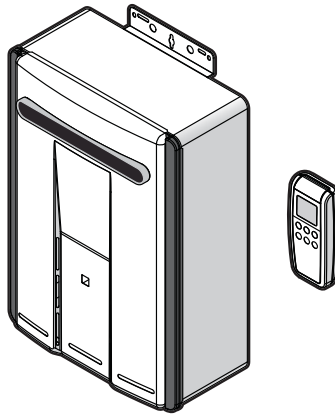

- The Rinnai Continuous Flow water heater products **NEVER RUN OUT** of hot water. Whilst electricity, water and gas supplies are connected, hot water is available whenever hot water taps are open.
- Built into the main micro-processor is the facility to **LIMIT THE MAXIMUM TEMPERATURE** of the hot water supplied. The water temperature may be limited to various values. This is particularly useful when the hot water unit is installed where young children or the infirm may be using the hot water.
- The Rinnai Continuous Flow water heater products are Fan-Assisted (power flued) appliances. This makes them **COMPACT**, saving both floor and wall space.
- The temperature of hot water is **CONSTANTLY MONITORED** by a **BUILT-IN SENSOR**. If the temperature of the hot water rises to more than 3°C above the selected temperature the burner is turned **OFF** and only turned **ON** again when the temperature falls below the selected temperature.
- The burner lights automatically when the hot water tap is opened, and goes out when the tap is closed. **IGNITION IS ELECTRONIC**, so there is no pilot light. When the hot water tap is off, no gas is used.
- This Rinnai Continuous Flow water heater product is supplied with one “MC-503” wireless water controller that is pre-programmed as a master controller.
- Additional ‘MC-503’ wireless water controllers are available as an optional extra.
- ‘Deluxe’ or ‘Universal’ Water Controllers are also available as an optional extra. Depending on the models chosen, these offer the following features:
 - Bath fill function (Deluxe Bathroom Control Only).
 - Voice Prompting (Deluxe Control Only).
 - Clock (Deluxe Control Only).
- Up to four water controllers can be fitted. See page 10 for details.
- The “Smartstart®” system when fitted can pre-heat the water in the pipe-work between the water heater and the hot water outlets. This results in water savings and reduces waiting time for heated water at the outlets.
- Operating **NOISE LEVEL IS VERY LOW**.
- **ERROR MESSAGES ARE DISPLAYED** on the Water Controllers and Status Monitor*, assisting with service. *All models in the range covered by this manual have a “Status Monitor”.

IMPORTANT INFORMATION

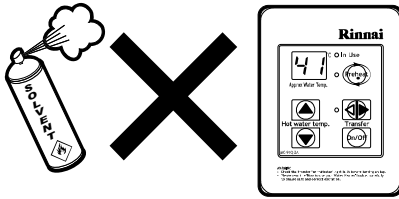

To clean your water controller(s) use a soft damp cloth with a mild detergent.

Do Not use solvents!

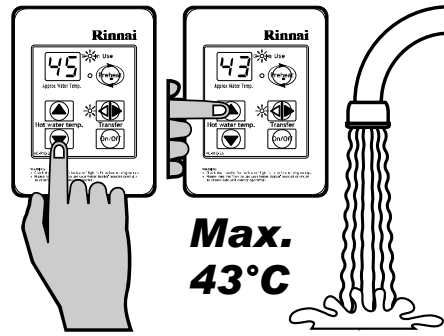

Whilst hot water outlets are open the set temperature may be lowered. However they cannot then be raised above 43°C. In addition transfer of 'priority' between controllers is not possible. These are safety features.

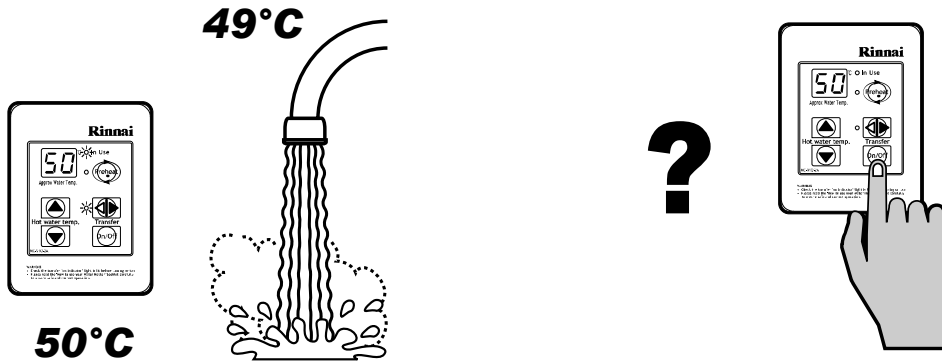

Depending on the weather conditions and the length of the pipe between the hot water unit and the outlet in use, there may be a variation between the temperatures displayed at the water controller(s) and the temperature of the water at the outlet.

There is no need to turn the water controller(s) off after use. However, if you prefer to turn the water controller(s) off, selected temperatures to a maximum of 50°C will be stored in the system memory at all times whilst mains power remains connected.

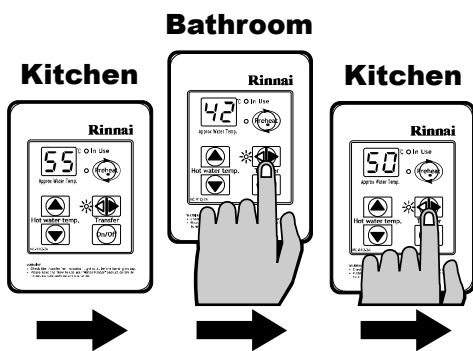

As a safety precaution, if a Kitchen Controller's temperature is set above 50°C, transferring and then returning 'priority' to the Kitchen Controller will result in a default set temperature of 50°C being selected. This is a safety feature.

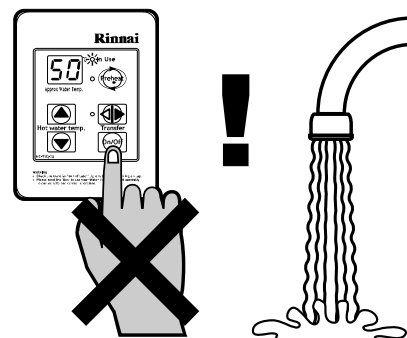

Do Not push the On/Off button on any Controller when the 'Red' water heater 'In Use' indicator is illuminated as this will turn off the water heater causing the water to go cold. Someone maybe in the middle of having a shower or filling a bath.

IMPORTANT INFORMATION



The range of Rinnai continuous flow water heaters referred to in this manual are incompatible with solar water heating systems. A dedicated range of solar compatible continuous flow water heaters is available from Rinnai.

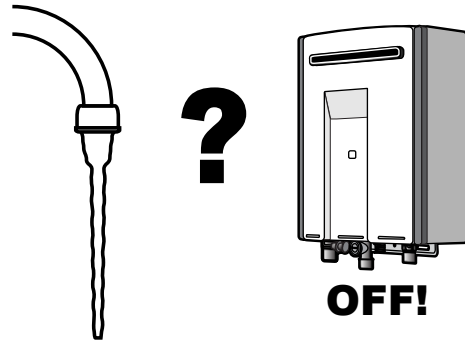
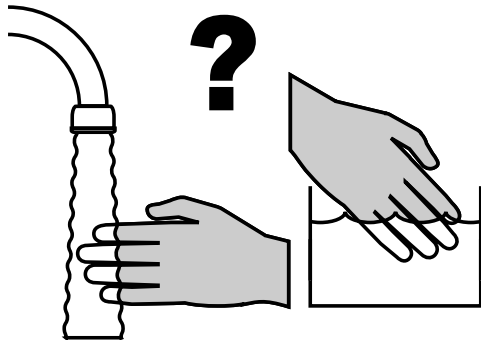

Always check water temperature carefully before use. Refer to the **WARNING ABOUT HOT WATER** on "page 4" of this manual for important safety information.

At low water flows, the hot water unit may extinguish without warning. Opening the tap further will restart the appliance.

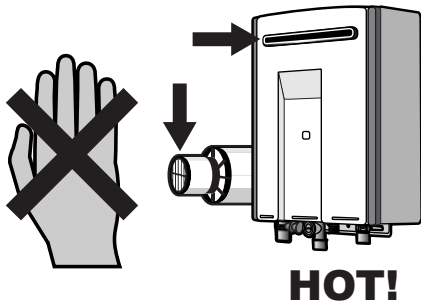

Do Not touch the unit cover or the flue outlet.

Do Not insert objects into the flue outlet.

Do Not spray water directly into the flue outlet.

Keep, trees, shrubs, etc. well clear of the flue outlet.

On colder days steam may discharged from the flue outlet. This condition is normal for high efficiency appliances and does not indicate a fault.

Do Not Spray aerosols in the vicinity of this appliance while it is in operation.

Do Not use or store flammable materials in or near this appliance.

Do Not place articles on or against this appliance.

Do Not modify this appliance.

Do Not store pool chemicals near this appliance.

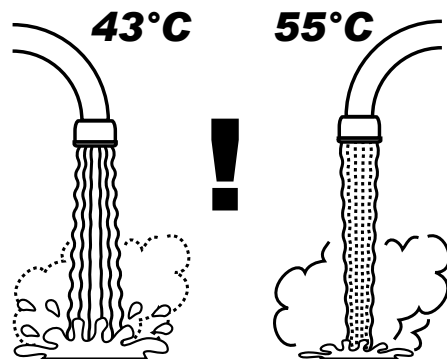
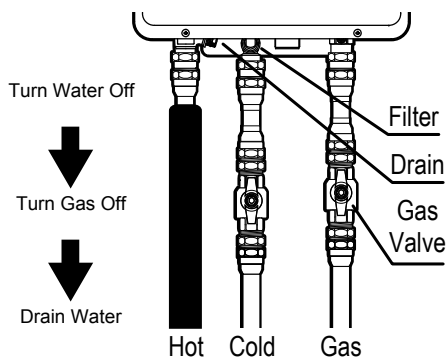

If freezing conditions are expected, turn off water and gas and drain all water from the appliance. If power and the automatic frost protection are connected, freezing will be prevented. (Anti-frost protection is fitted as standard equipment on External units and is available as an optional extra on Internal Units).

The delivered water temperature is controlled automatically. The flow may vary depending on the delivery temperature selected and the ambient water temperature.



OPERATION WITHOUT CONTROLLERS

Rinnai Continuous Flow water heater products do not use a pilot light.

When installed and operated without water controllers, the opening of any hot water tap will automatically start the appliance.

Once water is flowing through the appliance the burner will be ignited by electronic ignition.

When the hot water tap is closed and water flowing through the appliance has stopped the burner flame will extinguish.

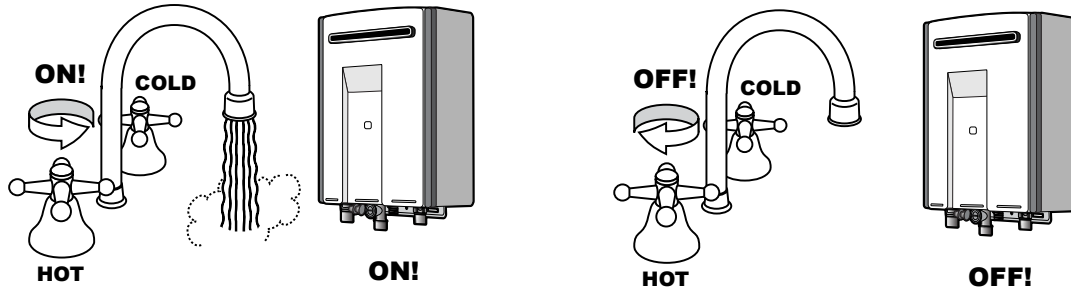

Heated water can be dangerous, especially for young children and the infirm.

Water temperatures above 50°C can cause severe burns instantly and may even result in death.

Those most at risk are children, disabled, elderly and the infirm.

Hot water at 65°C (a very common hot water temperature in Australia) can severely burn a child in less than half a second. At 50°C it takes five minutes.

ALWAYS.....

Test the temperature of the water with your elbow before placing your child in the bath, also carefully feel water before bathing or showering yourself.

Supervise children whenever they are in the bathroom.

Make sure that the hot water tap is turned off tightly.

CONSIDER.....

Installing child proof tap covers or child resistant taps (both approaches will prevent a small hand being able to turn on the tap).

Setting your appliance at a maximum temperature of 50°C (Contact Rinnai Australia).

NEVER.....

Leave a toddler in the care of another child. They may not understand the need to have the water temperature set at a safe level.

GENERAL WATER CONTROL INFORMATION

RADIO COMMUNICATIONS

Rinnai wireless water controllers are classified as short range radio communications devices and referred to as Low Interference Potential Devices (LIPD's) in AS/NZS 4268*. As such, they operate in the same radio frequency spectrum as many other devices classified as LIPD's such as garage door openers and keyless automobile entry systems. Although interference with other LIPD's is unlikely, it is not guaranteed interference will not occur.

Rinnai wireless water controllers must not be used in the vicinity of other devices if radio interference with such devices could result in a dangerous situation, unless it is verified that interference will not occur. Possible examples are medical devices and fire alarms.

*AS/NZS 4268 'Radio Equipment and systems – short range devices – Limits and methods of measurement'.

WATER RESISTANCE



The MC-503RC Wireless water controller is a water resistant device, however excessive exposure to water such as immersion may result in damage to the controller.

- **DO NOT immerse the controller into water.**
- **AVOID direct exposure to water or steam as these conditions may cause a malfunction.**
- **ALWAYS AVOID exposure to water when the battery compartment is open.**
- **When cleaning your water controller use ONLY a damp cloth and a mild detergent.**

MAXIMUM DELIVERY TEMPERATURES

Rinnai continuous flow water heaters are factory pre-set to various maximum delivery temperatures depending on model and their intended application. For the majority of applications, the factory pre-set temperature is appropriate. In the unlikely event this is not the case this setting can be increased or decreased by an authorised person such as a licensed plumber.



This does not apply to "50 degree compliant" models. To meet the regulatory requirements the maximum delivery temperature is factory set and sealed.

Factory pre-set delivery temperatures for the various models are as follows:

MODEL NUMBER	MODEL NAME	FACTORY "PRE-SET" MAXIMUM DELIVERY TEMPERATURE (°C)	CAN FACTORY "PRE-SET" MAXIMUM DELIVERY TEMPERATURE BE CHANGED BY AN AUTHORISED PERSON?
REU-VRM2626WD	INFINITY 26 Touch	60	Yes
REU-VRM2626WD-50	INFINITY 26 Touch - 50°C Compliant	50	No

Note: The model number is written on the dataplate on the left hand side of appliance

Water controllers allow precise temperature control by the user. When used correctly, the hot water unit will deliver the selected temperature, even when the water flow is varied, or more than one tap is in use. Each water controller can be individually programmed, however the water heater can only deliver one set temperature at any time. The available temperatures (°C) are as follows:

Master Controller (used in kitchen):

37, 38, 39, 40, 41, 42, 43, 44, 45, 46, 48, 50, 55°C* 60°C*, 65°C*, 75°C*

Bathroom Controller (used in bathrooms, ensuites, toilets and laundry):

Hot Water Delivery: 37, 38, 39, 40, 41, 42, 43, 44, 45, 46, 48, 50°C

Whilst hot water outlets are open the set temperature may be lowered. However the set temperature cannot then be raised above 43°C. In addition transfer of 'priority' between controllers is not possible. These are safety features.

GENERAL WATER CONTROL INFORMATION

Suggested temperatures are:

Kitchen 50°C ~ 55°C*, Shower 37°C ~ 43°C

** Temperature may not be available on all installations. Rinnai water heaters can be programmed to deliver higher temperatures via the kitchen controller. Contact Rinnai for more details.*

These temperatures are suggestions only. You may find higher or lower temperatures more comfortable. Maintaining lower temperatures helps save energy. To obtain water temperatures lower than 37°C simply add cold water.

The temperature of outgoing hot water is constantly monitored by a built-in sensor. If the temperature of the outgoing hot water rises to more than 3°C above the selected temperature shown on the digital monitor, the burner will automatically go out. The 'In Use'  indicator will also go out. The burner will ignite again once the outgoing hot water temperature falls to that shown on the digital monitor.

Wireless water controllers can be fitted along with wired 'Universal' and 'Deluxe' water controllers. Wireless and Universal water controllers allow temperature selection only. Deluxe water controllers allow temperature selection, have a clock function and on the Deluxe Bathroom water controller BC-100V a shower saver / bath fill function is also available.

Available configurations for Wireless and Wired Water Controllers:

<p>For Wireless Only Installations</p>	<p>A maximum of 4 wireless water controllers can be fitted with the following limitation:</p> <p>Only <u>ONE</u> MC-503RC can be set as the Master Controller.</p> <p><u>NOT</u> compatible with MC-502RC wireless water controllers.</p>
<p>For Combination Wired & Wireless Installations</p>	<p>A maximum of 4 water controllers can be fitted. Any combination of deluxe, universal and wireless controllers can be used with the following limitations:</p> <p>Only <u>ONE</u> master controller can be installed. This can be a MC-100V, a MC-91Q (when programmed as a master controller) or a MC-503RC water controller. Note that when a MC-100V is fitted it will always function as a master controller, this is the default setting and can not be changed.</p> <p>Up to <u>TWO</u> BC-100V water controllers can be installed.</p> <p>The <u>FOURTH</u> water controller in any installation MUST BE a MC-503RC or a MC-91Q.</p> <p><u>NOT</u> compatible with MC-502RC wireless water controllers.</p>

WIRELESS WATER CONTROLLERS

ABOUT THE WIRELESS WATER CONTROLLER (MC-503RC)

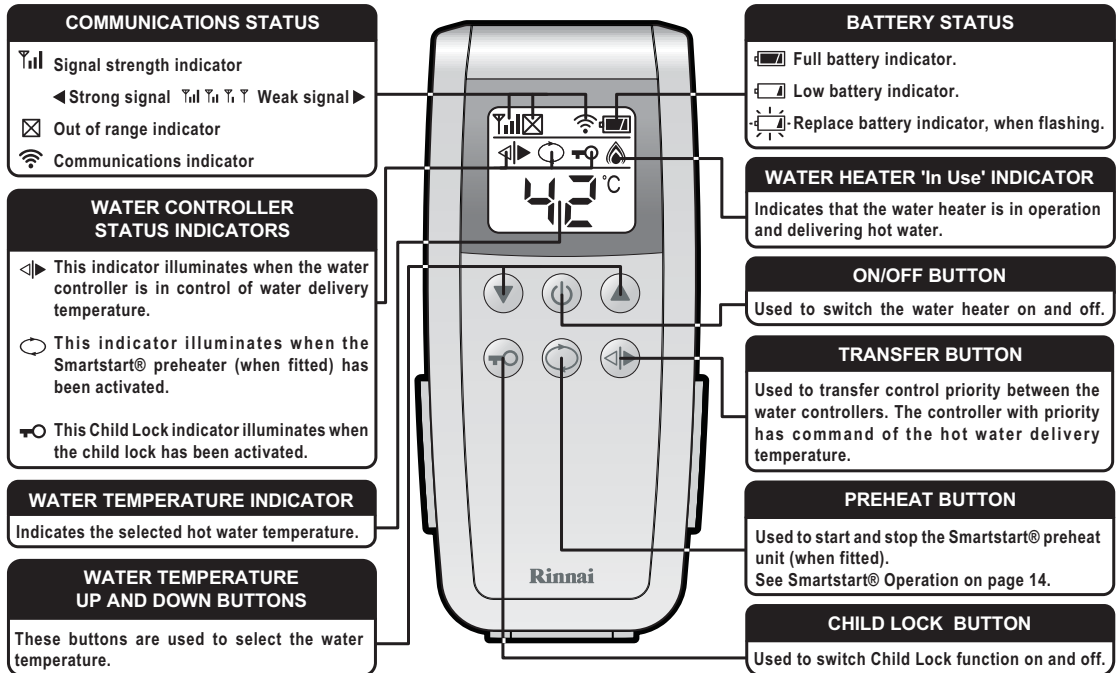

TURNING ON THE WATER HEATER.

When the water heater is in the 'Off' condition only the communications and battery status indicators are displayed on the digital monitor. To turn the water heater 'On', press the On/Off button once (if Child lock is activated see page 12). The communications indicator will briefly illuminate to confirm that a signal has been sent to the transceiver connected to the water heater.

The transfer indicator and the water temperature display will flash until communication between the controller and transceiver is complete. When the display stops flashing the water heater is ready to supply hot water.

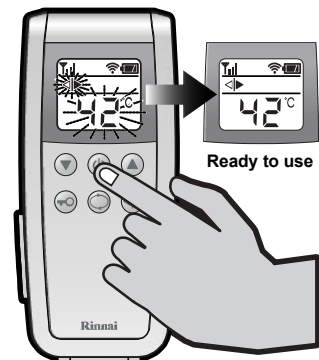

ADJUSTING TEMPERATURE

Simply press the 'hot water temp' or buttons until the required temperature is displayed on the digital monitor. The water temperature and any active status indicator will flash until communication between controller and transceiver is complete. **DO NOT** open the hot water tap until the flashing stops and the desired temperature is displayed.

To operate the water heater, open any hot water tap. This will automatically light the burner, providing hot water. The 'In Use' indicator will illuminate on the water controller.

Once the hot water is running, if the set temperature is either too hot or cold press the or buttons until the desired temperature is reached.

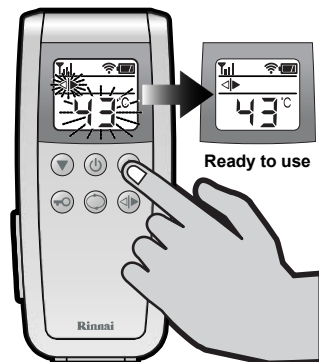

NOTE Whilst hot water outlets are open the set temperature may be lowered to a minimum of 37°C. For safety, it cannot then be raised above 43°C until all hot water taps are closed.

If the water heater is turned 'Off' whilst hot water taps are open it can not be turned back 'On' until all hot water taps have been closed.



CAUTION Always check water temperature at the outlet before use. A parent or carer should always check the temperature before a child is placed in contact with hot water, see page 4.

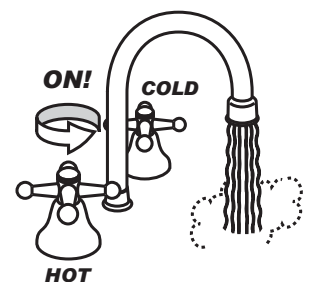

WIRELESS WATER CONTROLLERS

TRANSFERRING PRIORITY BETWEEN WATER CONTROLLERS

To control the water delivery temperatures when using two or more controllers it is necessary to have priority transferred to the water controller you wish to use.

An illuminated Transfer ◀▶ indicator confirms that the desired water controller is in control of the water delivery temperature.

If the Transfer ◀▶ indicator is not illuminated press the 'Transfer' ◀▶ button to transfer priority to the desired water controller.

The Transfer ◀▶ indicator on the water controller will now illuminate to indicating that priority has been transferred and that the water heater is ready to supply hot water once a hot water tap is opened.

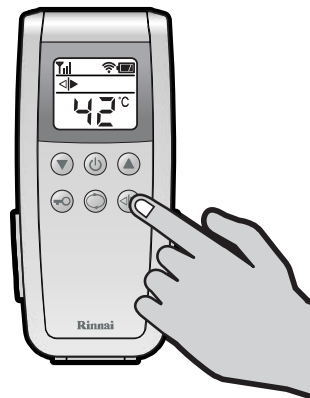

Whilst hot water taps are open transfer of 'priority' between controllers is not possible. This is a safety feature.

HOT WATER CONTROL

Temperatures higher than 50°C should only be able to be selected on the controller labelled 'Master' controller (used in the kitchen), not on those labelled 'Bathroom' controllers. This helps minimise the risk of burns.

The wireless transceiver has been incorrectly assigned if temperatures in excess of 50°C are able to be selected on controllers used in bathrooms, ensuites, toilets and laundries. Re-assign the wireless transceiver if this is the case. See "UN-ASSIGNING AND RESETTING WIRELESS WATER CONTROLLERS" on page 36 and "INSTALLING WIRELESS WATER CONTROLLERS" on page 34

USING CHILD LOCK FUNCTION

The Child Lock function is designed to prevent small children or the infirm from operating the wireless controllers.

To Activate the Child Lock

To activate the Child Lock function press the ◀○ button for 3 seconds. The Child Lock ◀○ indicator will illuminate to confirm that the function is now active. Once activated only the initiating controller can then deactivate this function?

To Deactivate the Child Lock

To deactivate the Child Lock function press the ◀○ button for 3 seconds. The Child Lock ◀○ indicator will go out to show that the function is no longer active.

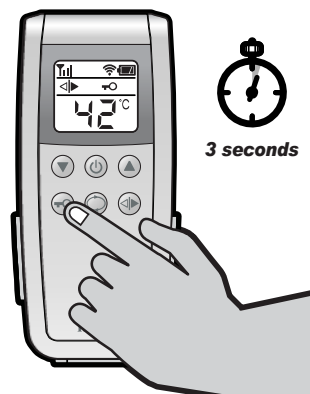

Child lock only applies to the water controller initiating the function and can be activated / de-activated regardless of priority ◀▶ status or whether the water heater is in the 'On' or 'Off' condition.

While the child lock is activated only the 'Child Lock' ◀○ control and the 'Off' ⏻ control are functional from that controller.

When the water heater is turned 'Off' while Child lock is activated it can not be turned 'On' again from a controller where the Child lock is activated.

If the water heater is turned 'Off' whilst hot water outlets are open it can not be turned back 'On' until all hot water outlets have been closed.

Child lock is de-activated during a battery change or when batteries fail.

WIRELESS WATER CONTROLLERS

WIRELESS WATER CONTROLLERS BATTERIES

Wireless water controllers use 2 x 1.5V AAA batteries. The battery symbol in the display monitor indicates the remaining charge in one of three levels.

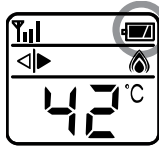

Battery charge level OK.

Battery charge level is low.

Batteries need replacing (when flashing)

To replace the batteries:

Before attempting to change the batteries first ensure that all moisture has been removed from the water controller. Failure to do so may allow water to enter the water controller causing damage.

1. Remove the controller from the wall mounting bracket.
2. To open the battery compartment turn the battery compartment cover a full turn anti-clockwise.
3. Insert the batteries observing the correct polarity as shown on the rear of the controller.
4. To close the battery compartment align the " Δ " and " ∇ " marks on the battery compartment cover and the controller body. Then turn the battery compartment cover a full turn clockwise to obtain the correct seal.
5. Return the controller to the wall mounting bracket.

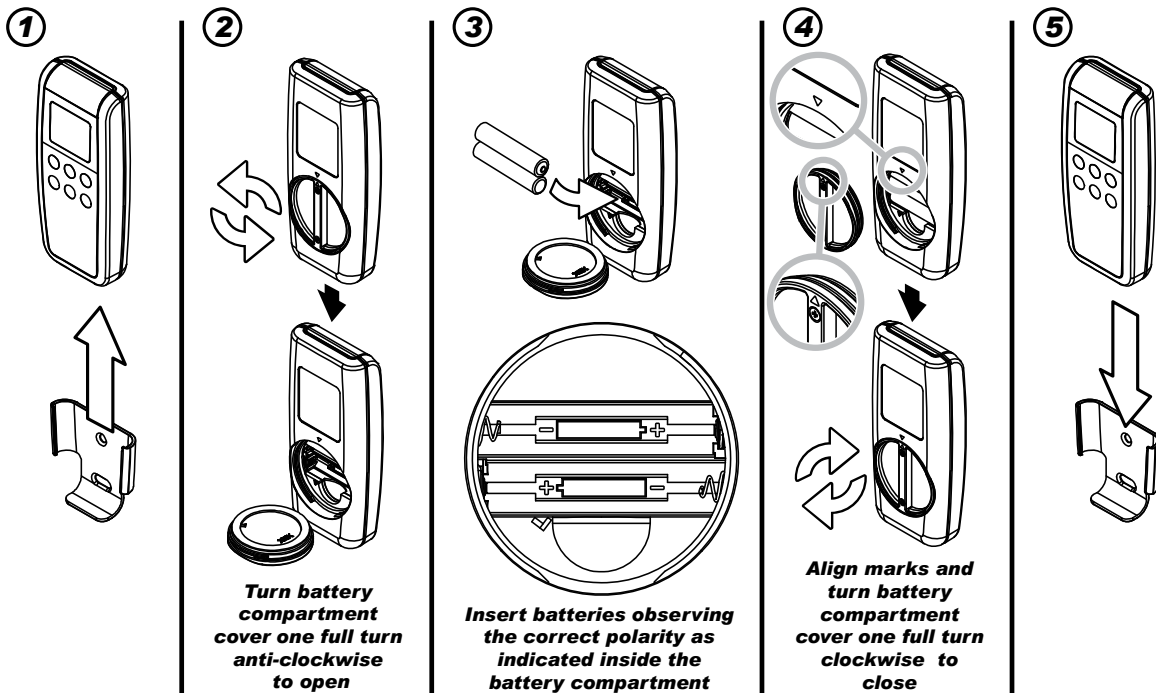

Use only 2 x 1.5V AAA alkaline batteries.

DO NOT

- mix old and new batteries.
- use different types of batteries at the same time.
- heat or expose to flame.
- take apart or short circuit.
- attempt to recharge alkaline batteries.
- use batteries if their covering has been damaged or peeled off.

Battery life is approximately 1 year.

- Dispose of used batteries according to the manufacturers instructions.

Remove batteries if the water controller is not going to be used for a long period. This will help avoid damage from leaking batteries.

WIRELESS SMARTSTART PRE-HEAT OPERATION

ABOUT THE SMARTSTART® PRE-HEAT SYSTEM

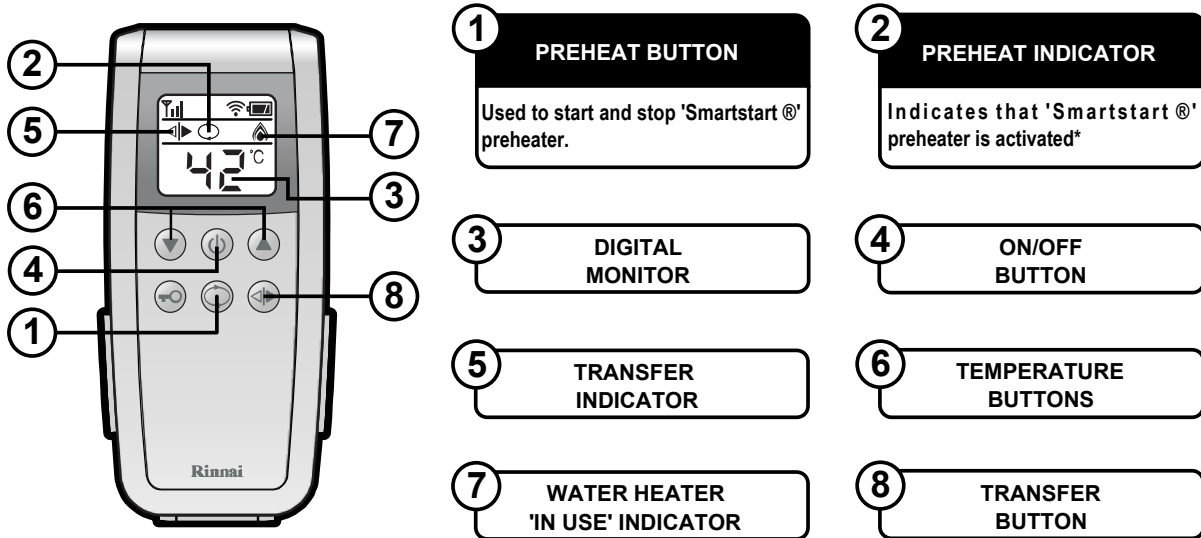

Preheat Function

The “Preheat” function works in conjunction with various Rinnai water heater models and the separately installed and optional Rinnai “Smartstart®” module.

When the “Preheat” function is activated and used in accordance with these instructions, water in the pipework connected between the water heater and the hot water outlets in your house is warmed before any outlets are opened. This results in water savings and added convenience.

The preheat function is activated as follows:

1. Ensure that the hot water unit is on (temperature digits are displayed in the digital monitor ③). If more than one controller is fitted press the ‘Transfer’ ⑧ button to pass on priority to your desired controller. The ‘Transfer’ ⑤ indicator will illuminate to confirm that priority has been assigned to this controller and that the hot water unit is ready to deliver hot water.
2. Select the desired temperature using the ‘Temperature’ ⑥ buttons until the required temperature is displayed in the digital monitor ③.
3. Press the ‘Preheat’ ① button once. The ‘Preheat’ ② indicator and the ‘In Use’ ⑦ indicator will illuminate, signifying that the preheat system has been activated.
4. Wait approximately two minutes before opening an outlet. This will allow the water in the pipework to be warmed.



NOTE

The waiting time may be longer or shorter than two minutes depending on your particular installation configuration.

The preheat function is cancelled 5 minutes after activation and the ‘Preheat’ indicator will go out. This is to conserve energy. To reactivate, simply repeat steps 2-4 above.

* If the ‘Preheat’ button is pressed and the ‘Smartstart®’ preheat unit is not installed, the ‘Preheat’ indicator will still light but there will be no preheat function. The ‘Preheat’ indicator will go out after a short time and will not affect the other functions of the water controller or water heater.

Other Water Controller Functions

Water controller functions such as temperature control and transfer of priority between multiple controllers are not affected by the operation of the preheat. Such functions are described in the applicable sections of this manual.

UNIVERSAL WATER CONTROLLERS

ABOUT THE UNIVERSAL WATER CONTROLLER (MC-91Q)

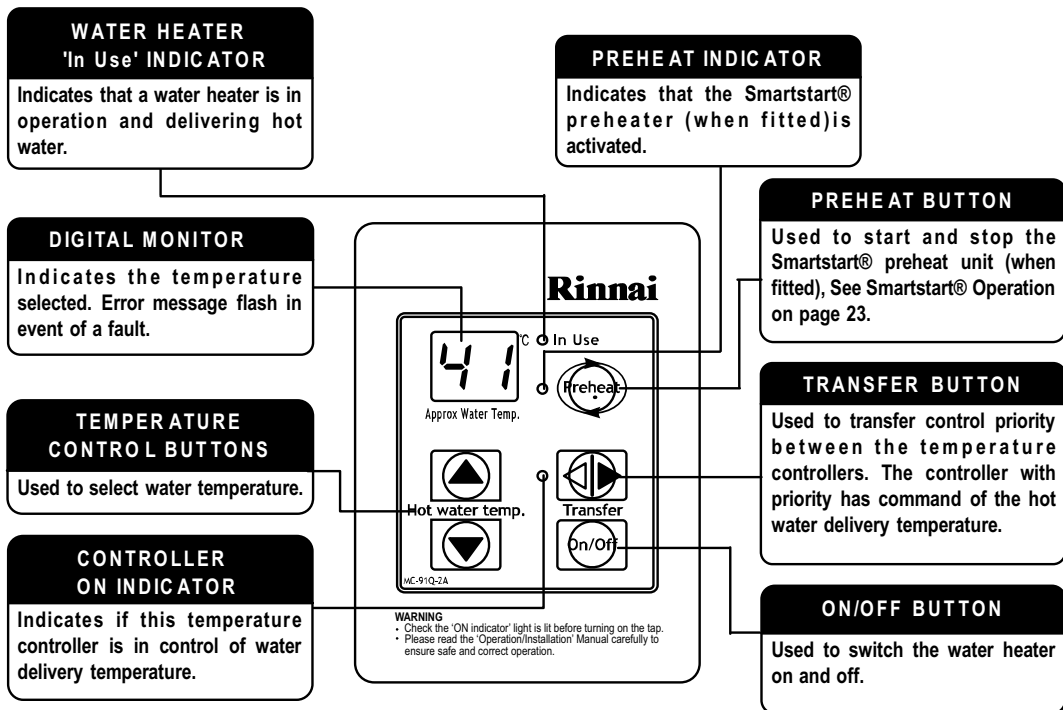



TURNING ON THE WATER CONTROLLER



If the water controller is switched off (No digits displayed in the digital monitor window) press the On/Off button once.

The ON indicator will illuminate, indicating that the hot water unit will be ready to supply hot water once a hot water tap is opened.

ADJUSTING TEMPERATURE

Select the desired temperature using the 'Hot water temp'  or  buttons until the required temperature is displayed on the digital monitor.

To operate the hot water unit, open any hot water tap. This will automatically light the burner providing hot water. The water heater 'In Use' indicator will illuminate on the water controller.

Once the hot water is running, if the set temperature is either too hot or cold press the 'Hot water temp'  or  buttons until the desired temperature is reached.

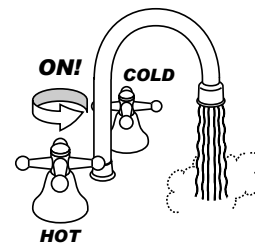
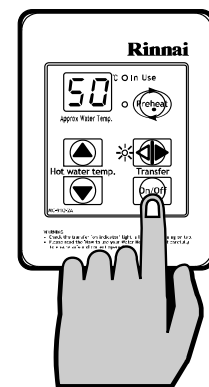

CHECK WATER TEMPERATURE BEFORE USE.

A parent or carer should always check the temperature before a child is placed in contact with hot water, see page 8.



Whilst hot water outlets are open the set temperature may be lowered. However they cannot then be raised above 43°C. In addition, transfer of 'priority' between controllers is not possible. These are safety features.

The 'beep' sound can be muted by pressing the 'Hot water temp' Up  and Down  buttons simultaneously for more than 3 seconds.

UNIVERSAL WATER CONTROLLERS

HOW TO USE TWO OR MORE UNIVERSAL WATER CONTROLLERS

TURNING ON THE WATER CONTROLLERS

If the controllers are switched off (No digits displayed in the digital monitor window) press the On/Off button once at any controller.



The ON indicator on the desired controller will illuminate, indicating that the hot water unit will be ready to supply hot water once a hot water tap is opened.

TRANSFERRING PRIORITY



An illuminated On/Off indicator confirms that the desired controller is in control of the water delivery temperature, if the On/Off indicator is not illuminated press the TRANSFER button once.

The On/Off indicator on the controller will now illuminate indicating that hot water temperature control has now been transferred to this controller and that the hot water unit will be ready to supply hot water once a hot water tap is opened.

ADJUSTING TEMPERATURE

Select the desired temperature using the 'Hot water temp'  or  buttons until the required temperature is displayed on the digital monitor.

To operate the hot water unit, open any hot water tap. This will automatically light the burner providing hot water. The water heater 'In Use' indicator will illuminate on the water controller.

Once the hot water is running, if the set temperature is either too hot or cold press the 'Hot water temp'  or  buttons until the desired temperature is reached.

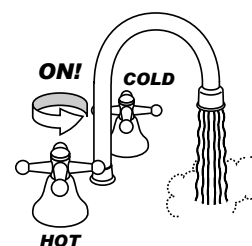
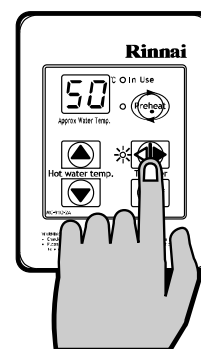
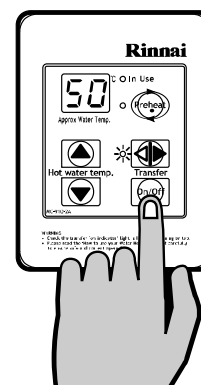

CHECK WATER TEMPERATURE BEFORE USE.

A parent or carer should always check the temperature before a child is placed in contact with hot water, see page 8.



Whilst hot water outlets are open the set temperature may be lowered. However they cannot then be raised above 43°C. In addition transfer of 'priority' between controllers is not possible. These are safety features.

Temperatures higher than 50°C should not be able to be selected on controllers installed in bathrooms, ensuites or toilets. This is to help reduce the risk of burns from hot water. If this is not the case, the controllers have been incorrectly installed. CONTACT YOUR INSTALLER.

The temperature of outgoing hot water is constantly monitored by a built-in sensor. If the temperature of the outgoing hot water rises to more than 3°C above the selected temperature shown on the digital monitor or the pre-set limit when water controllers are not fitted, the burner will automatically go out. The 'in use' indicator will also go out. The burner will ignite again once the outgoing hot water temperature falls to that shown on the digital monitor (or the pre-set limit of the appliance).

DELUXE BATHROOM WATER CONTROLLERS

ABOUT THE DELUXE BATHROOM WATER CONTROLLER (BC-100V)

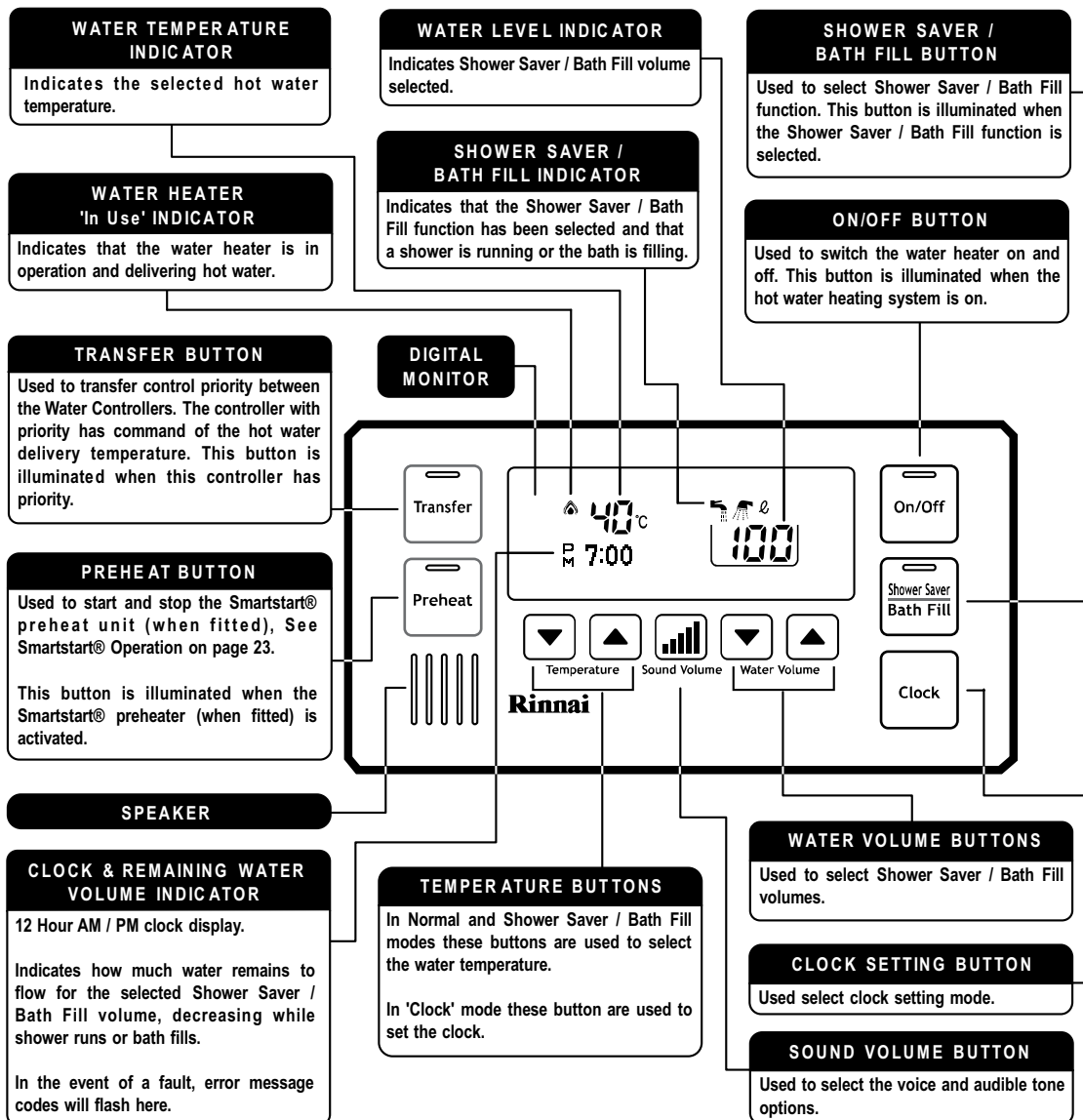

NOTE Refer to page 10 to confirm the maximum number and combination of controllers that can be fitted to your Water Heater model.

Avoid getting water directly in the speaker as this may cause damage.

TURNING ON THE WATER CONTROLLER

If the controller is switched off (No digits other than the clock digits displayed in the digital monitor) press the On/Off button once.

The On/Off and Transfer buttons illuminate to indicate that the hot water unit will be ready to supply hot water once a hot water tap is opened.

If more than one controller is fitted press the 'Transfer' button to transfer priority to the desired controller.

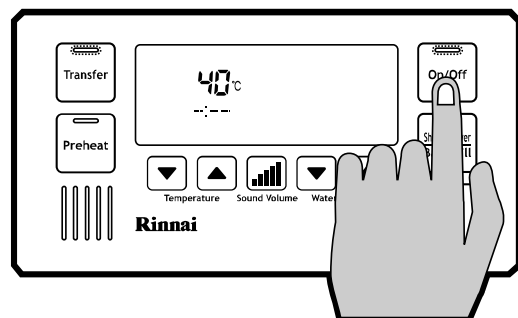



DELUXE BATHROOM WATER CONTROLLERS

SETTING THE SOUND OPTIONS

To set the sound options press the 'Sound Volume'  button and select the desired audible setting as follows:



Voice High, Med, Low or Off, sets the voice prompt volume but does not affect the audible tones.
Sound OFF, mutes all voice prompts and audible tones.

Press any of the  or  buttons to return to normal mode, if no buttons are pressed for a period of approximately 10 seconds the controller will return to normal mode

SETTING THE CLOCK

The clock is a 12 hour AM/PM style display.

To set the time press the 'Clock'  button once, this places the controller into clock setting mode, in the digital monitor the clock digits will flash, if this is the first time the clock has been set the starting time will be AM 12:00.

Use the 'Temperature'  or  buttons to select the desired time, holding these buttons down continuously cycles the digits. When you get close to the time you wish to set, press the button intermittently to avoid going further than the desired time.

To return to normal mode press the 'Clock'  button once, if no buttons are pressed for a period of approximately 60 seconds the controller will return to normal mode.

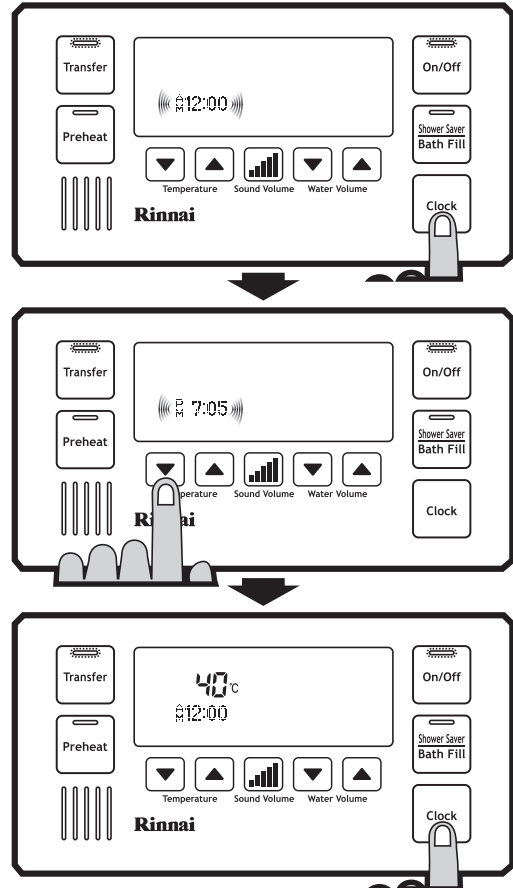



The time is always displayed regardless of whether the water controller is turned ON or OFF.

The clock may need resetting if power to the water heater unit is disrupted due to a power failure or if the power is switched off over a prolonged period.

ADJUSTING TEMPERATURE

Simply press the 'Temperature'  or  buttons until the required temperature is displayed on the digital monitor.

To operate the water heater, open any hot water tap. This will automatically light the burner, providing hot water. The 'In Use' indicator  will illuminate on all water controllers.

Once the hot water is running, if the set temperature is either too hot or cold press the 'Temperature'  or  buttons until the desired temperature is reached.

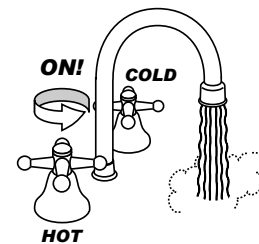

Whilst hot water outlets are open the set temperature may be lowered. However it cannot then be raised above 43°C. In addition, transfer of 'priority' between controllers is not possible. These are safety features.



CHECK WATER TEMPERATURE BEFORE USE.
A parent or carer should always check the temperature before a child is placed in contact with hot water, see page 8.

DELUXE BATHROOM WATER CONTROLLERS

OPERATING THE SHOWER SAVER / BATH FILL FUNCTION

The 'Shower Saver / Bath Fill' function allows a preset water volume and temperature to be selected and run automatically.





No voice prompts will be available if the 'Voice OFF' or 'Sound OFF' options are selected. With 'Sound OFF' there will also be no audible tones.

Initial Settings

When a deluxe bathroom controller is first turned on, the default shower / bath fill temperature is set to 40°C and the shower / bath volume is set to 100 litres. The shower / bath volume can be lowered to a minimum of 30 litres or raised to a maximum of 400 litres and the temperature adjusted as desired.



Setting Shower / Bath Temperature and Volume

With the system on, select a Deluxe Bathroom water controller and ensure that it currently has priority. If it does not have priority press the 'Transfer'  button once and the 'Transfer' button will illuminate.

Press 'Shower Saver / Bath Fill'  button once. The 'Shower Saver / Bath Fill' button will illuminate and a voice prompt and tone will sound.

To select the desired delivery temperature use the 'Temperature'  or  buttons.

The selected temperature will be displayed on the digital monitor and will remain as the default 'Shower Saver / Bath Fill' temperature until it is changed or if the mains power is turned off for an extended period.

To select the volume of water to be used in the shower / bath use the 'Water Volume'  or  buttons. The selected volume is displayed in large digits to the right and will remain as the default 'Water Volume' until it is changed or if the mains power is turned off for an extended period.

The selected volume is also repeated in the form of a remaining volume counter below the temperature and replaces the clock during 'Shower Saver / Bath Fill' operations.

When filling a bath for the first time, it is recommended that a low bath fill volume such as 60 litres or lower be used. During any subsequent bath fills the volume can then be adjusted to suit your known bath volume and or desired fill level.



Be careful not to overfill the bath, an average bath volume is 160 litres. It is recommended that when filling a bath for the first time you should:

- Remain by the bath during the filling process.
- Use a low bath fill volume such as 60 litres or less.

When Smartstart® (page 23) is in operation, the Shower Saver / Bath Fill function is unavailable while the water heater 'In Use' indicator  is illuminated. Do not press the Preheat button whilst Shower Saver / Bath Fill is in operation as the programmed bath fill volume will not be met.

Using Shower Saver / Bath Fill

Press 'Shower Saver / Bath Fill'  button once. The 'Shower Saver / Bath Fill' button will illuminate and a voice prompt and tone will sound. During 'Shower Saver / Bath Fill' operations the 'Bath' indicator will also be displayed in the Deluxe Kitchen water controller digital monitor (when fitted).

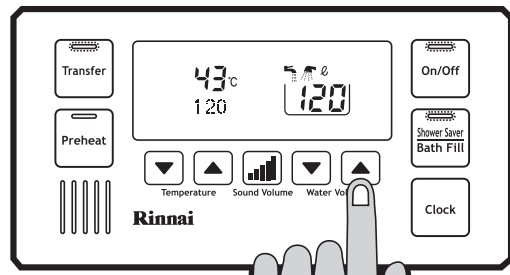
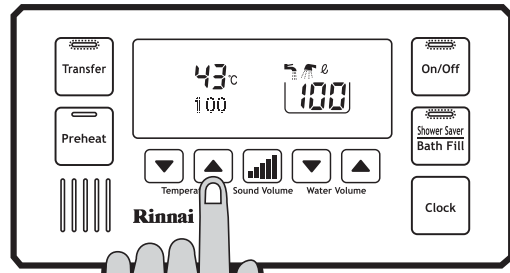
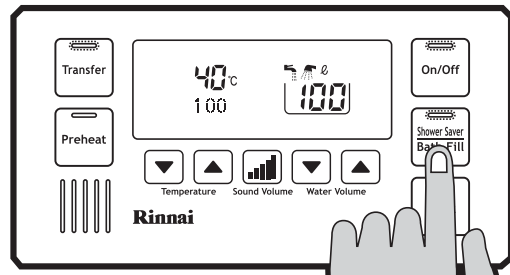

DELUXE BATHROOM WATER CONTROLLERS

The voice prompt will say "The hot water system is ready. Open the hot water tap". Open the hot water tap for the relevant shower or bath.

The 'In Use' indicator  will illuminate on all Deluxe water controllers and the shower will run or the bath will start to fill.

To Stop Shower Saver / Bath Fill Operation

If you wish to stop the water flow whilst the Shower Saver / Bath Fill function is in operation, simply press the 'Shower Saver / Bath Fill'  button.

The 'Shower Saver / Bath Fill' button will flash and the voice prompt will say "Hot water is not available, Turn off all hot water taps and push the 'Bath Fill' button". Follow the voice prompt instructions.

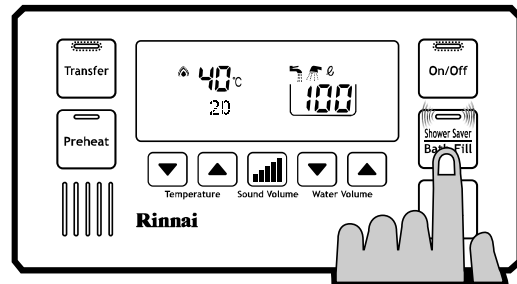
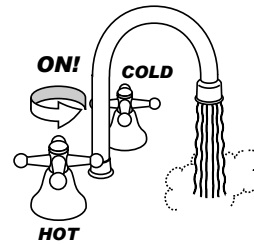

When Shower Saver / Bath Fill Operations Finishes

Once the Shower Saver / Bath Fill operation finishes the following events will occur:

1. The flow from the shower / bath hot water tap ceases.
2. The 'Shower Saver / Bath Fill' button will flash.
3. The Deluxe Kitchen water controller 'Bath' indicator will flash.
4. A tone will sound.
5. The voice prompt will say "Bath fill is complete. Turn off the bath hot water tap and push the Bath Fill button."

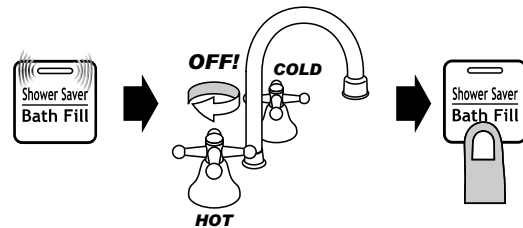

Follow the voice prompts instructions. Note that the water heater will not allow hot water to flow from any fixture until the 'Shower Saver / Bath Fill'  button has been pressed.

6. The 'Shower Saver / Bath Fill' button light on the Deluxe Bathroom water controller and the 'Bath' indicator on the Deluxe Kitchen water controller monitor (when fitted) will go out.



CHECK WATER TEMPERATURE BEFORE USE.

A parent or carer should always check the temperature before a child is placed in contact with hot water, see page 8.

NEVER LEAVE YOUNG CHILDREN UNATTENDED IN THE BATH.

When using the 'Shower saver / Bath fill' function, ALWAYS close the hot water tap for the bath or shower after the flow has stopped.



Whilst hot water outlets are open the set temperature may be lowered. However it cannot then be raised above 43°C. In addition transfer of 'priority' between controllers is not possible. These are safety features.

USING MULTIPLE WATER CONTROLLERS

The water heater can be turned on and off at any water controller. If more than one water controller is fitted press the 'Transfer'  button to transfer priority to the desired controller.

COMBINING UNIVERSAL AND DELUXE WATER CONTROLLERS

Universal and Deluxe water controllers can be combined and will function as described in other sections of the Water Heater Operation / Installation Manual. Refer to page 10 to confirm the maximum number and combination of controllers that can be fitted to your water heater model.

DELUXE KITCHEN WATER CONTROLLERS

ABOUT THE DELUXE KITCHEN WATER CONTROLLER (MC-100V)

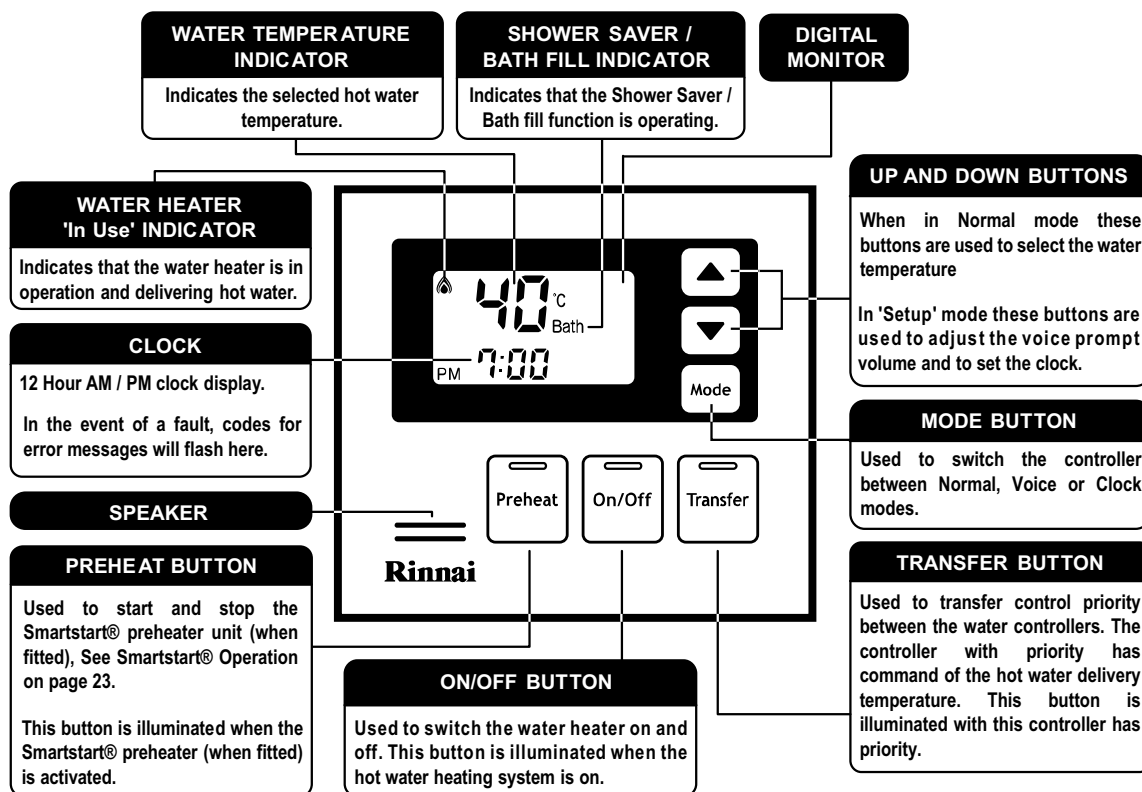

NOTE

Only one MC-100V may be fitted to your water heater. Refer to page 10 to confirm the maximum number and combination of controllers that can be fitted to your Water Heater model.

The MC-100V controller is not water resistant, avoid direct exposure to water or steam as these conditions may cause a malfunction.

TURNING ON THE WATER CONTROLLER

If the controller is switched off (No digits other than the clock digits displayed in the digital monitor) press the On/Off button once.

The On/Off and Transfer buttons illuminate to indicate that the hot water unit will be ready to supply hot water once a hot water tap is opened.

If more than one controller is fitted press the 'Transfer'  button to transfer priority to the desired controller.

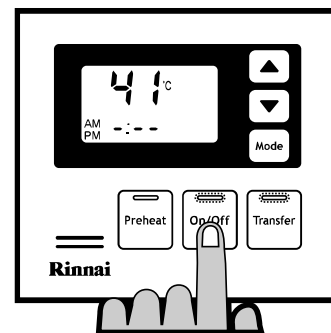

SETTING THE SOUND OPTIONS

To set the sound options press the 'Mode'  button once to place the controller into 'Voice' mode.

Use the ▲ or ▼ buttons to select the desired audible setting as follows:

Voice High, Med, Low or Off, sets the voice prompt volume but does not affect the audible tones.

Sound Off, mutes all voice prompts and audible tones.

To return to normal mode press the 'Mode'  button once, if no buttons are pressed for a period of approximately 10 seconds the controller will return to normal mode.



NOTE

Voice prompts only available when Deluxe Bathroom water controller(s) are installed.

DELUXE KITCHEN WATER CONTROLLERS

SETTING THE CLOCK

The clock is a 12 hour AM/PM style display. To set the time press the 'Mode'  button twice. This places the controller into clock setting mode and in the digital monitor the word 'Clock' will be displayed and the clock digits will flash. If this is the first time the clock has been set the starting time will be AM 12:00.

Use the ▲ or ▼ buttons to select the desired time. Holding these buttons down continuously cycles the digits. When you get close to the time you wish to set, press the button intermittently to avoid going further than the desired time.

To return to normal mode press the 'Mode'  button once. If no buttons are pressed for a period of approximately 10 seconds the controller will return to normal mode.

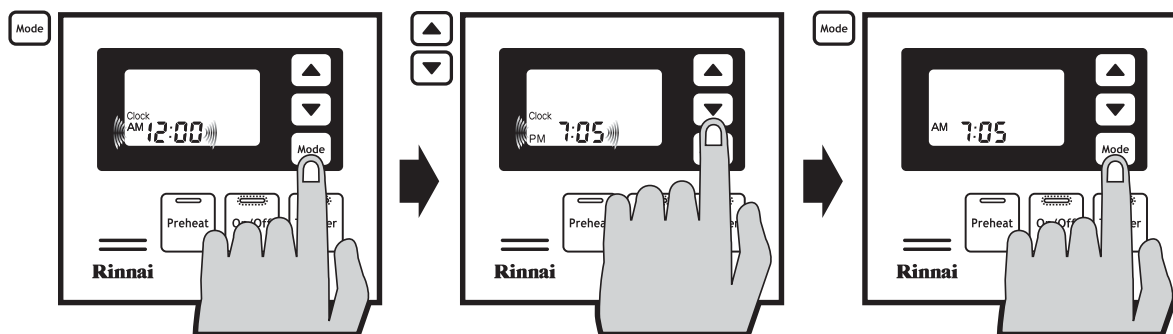

The time is always displayed regardless of whether the water controller is turned ON or OFF.

The clock may need resetting if power to the water heater unit is disrupted due to a power failure or if the power is switched off over a prolonged period.

ADJUSTING TEMPERATURE

Simply press the 'hot water temp' ▲ or ▼ buttons until the required temperature is displayed on the digital monitor.

To operate the water heater, open any hot water tap. This will automatically light the burner, providing hot water. The 'In Use' indicator  will illuminate on the water controller.

Once the hot water is running, if the set temperature is either too hot or cold press the ▲ or ▼ buttons until the desired temperature is reached.

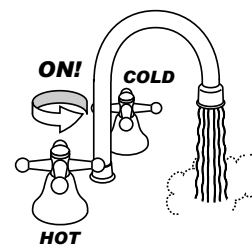

Whilst hot water outlets are open the set temperature may be lowered. However it cannot then be raised above 43°C. In addition transfer of 'priority' between controllers is not possible. These are safety features.



CHECK WATER TEMPERATURE BEFORE USE.

A parent or carer should always check the temperature before a child is placed in contact with hot water, see page 8.

WIRED SMARTSTART PRE-HEAT OPERATION

ABOUT THE SMARTSTART® PREHEAT SYSTEM

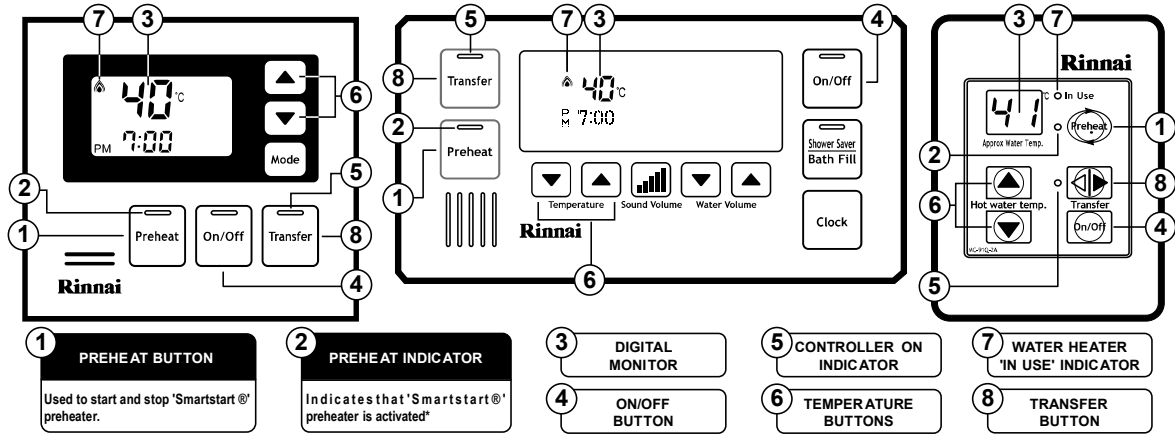

Preheat Function

The “Preheat” function works in conjunction with various Rinnai water heater models and the separately installed and optional Rinnai “Smartstart®” module.

When the “Preheat” function is activated and used in accordance with these instructions, water in the pipework connected between the water heater and the hot water outlets in your house is warmed before any outlets are opened. This results in water savings and added convenience.

The “Preheat” function is activated as follows:

1. Ensure that the hot water unit is on (temperature digits are displayed in the digital monitor ③). If more than one controller is fitted press the ‘Transfer’ ⑧ button to pass on priority to your desired controller, the ‘Controller On’ ⑤ indicator will illuminate to confirm that priority has been assigned to this controller and that the hot water unit is ready to deliver hot water.
2. Select the desired temperature using the ‘Temperature’ ⑥ buttons until the required temperature is displayed in the digital monitor ③.
3. Press the ‘Preheat’ ① button once. The ‘Preheat’ ② indicator and the ‘In Use’ ⑦ indicators will illuminate, signifying that the preheat system has been activated.
4. Wait approximately two minutes before opening an outlet. This will allow the water in the pipework to be warmed.



NOTE

The waiting time may be longer or shorter than two minutes depending on your particular installation configuration.

The “Preheat” function is cancelled 5 minutes after activation and the ‘Preheat’ indicator will go out. This is to conserve energy. To reactivate, simply repeat steps 2-4 above.

* If the ‘Preheat’ button is pressed and the ‘Smartstart®’ preheat unit is not installed, the ‘Preheat’ indicator will still light but there will be no “Preheat” function. The ‘Preheat’ indicator will go out after a short time and will not affect the other functions of the water controller or water heater.

After using the Shower Saver / Bath Fill function wait 30 seconds before activating the “Preheat” function. Attempting to use the “Preheat” function earlier will result in voice prompts being repeated until the system is reset. The system can be reset by pressing the ‘On /Off’ button twice.

Other Controller Functions

Controller functions such as temperature control and transfer of priority between multiple controllers is not affected by the operation of the preheat. Such functions are described in the applicable sections of this manual.

TROUBLESHOOTING

ERROR CODES

Your Rinnai Continuous Flow water heaters has a self diagnostic capability. If a fault occurs, an Error Code will flash on the digital monitor of your water controllers. This assists with diagnosing the fault, and may enable you to overcome a problem without a service call. Please quote the code displayed when enquiring about service.

CODE	FAULT	REMEDY
☒	Wireless water controller is 'Out of Range' due to distance from transceiver or an obstruction.	Move wireless water controller or transceiver or remove the obstruction.
-	Noticeable reduction in water flow.	Inlet water filter needs to be cleaned. Service call.
03	Power interruption during Bath fill (Water will not flow on power reinstatement).	Turn off all hot water taps. Press On/Off twice.
10	Air intake or flue blocked.	Service Call.
11	No ignition / No gas supply.	Check gas is turned on at water heater and gas meter or cylinder.
12	Flame Failure / Low gas flow.	Check gas is turned on at water heater and gas meter or cylinder. Check there are no obstructions to the flue outlet.
14	Remaining Flame Safety Device.	Service Call.
16	Over Temperature Warning.	Service Call.
32	Outgoing Water Temperature Sensor Faulty.	Service Call.
33	Heat Exchanger Outlet Sensor Faulty.	Service Call.
34	Combustion Air Temperature Sensor Faulty.	Service Call.
52	Gas Modulating Valve Faulty.	Service Call.
61	Combustion Fan Failure.	Service Call.
65	Water Flow Control Faulty (Does not stop flow properly).	Service Call.
71	Micro-processor Failure.	Service Call.
72	Micro-processor Failure.	Service Call.
LC	Scale build-up inside the heat exchanger.	Service Call.

In all cases, you may be able to clear the Error Code simply by turning the hot water tap OFF, then ON again. If this does not clear the Error Code, try pushing the On/Off button OFF, then ON again. If the Error Code still remains, contact Rinnai for advice.

No power display

When power to the water heater is disconnected the LCD of all wireless water controllers will display as shown. Check that power is available, the water heater is plugged in and that the power point is turned 'on'.

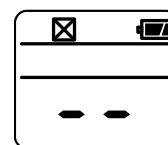

Troubleshooting Without Water Controllers

If you have no water controllers and experience the following symptoms, carry out these suggestions. If the symptom continues, contact Rinnai for advice.

FAULT	REMEDY
The unit does not attempt to start at all.	Check the power is on at the unit. Check the isolation valves at the unit are open.
The unit starts then shuts down immediately.	Check the power is still on. Check the gas isolation valves at the unit and the gas meter are fully open. Open your hot water tap fully.
The unit starts then the water goes cold.	Check the power is still on. Open your hot water tap further.



Faults caused by insufficient gas supply, insufficient water supply, gas quality, water quality, installation errors or operation errors are not covered by the Rinnai warranty. Refer to separate warranty booklet for details.

SERVICE

Wired and wireless water controllers, transceivers and water heaters do not contain user serviceable parts and must only be serviced and repaired by an authorised person.

Rinnai has a Service and Spare Parts network with personnel who are fully trained and equipped to give the best service on your Rinnai appliance. If your appliance requires service, please call our Hot Water Service Line. Rinnai recommends that this appliance be serviced every 3 years.

NOTES



This page is intentionally blank



INSTALLATION MANUAL

OPERATION MANUAL	3
GENERAL INSTALLATION INSTRUCTIONS	28
REGULATIONS	28
APPLICABLE MODELS	28
APPLIANCE LOCATION	28
PIPE SIZING	28
WATER SUPPLY	29
HOT WATER DELIVERY TEMPERATURE	29
WATER HEATER AND CONTROLLER INSTALLATION CONFIGURATIONS	29
MOUNTING THE APPLIANCE	29
SERVICE CONNECTION POINTS	30
RINNAI WIRELESS WATER CONTROLLERS	30
POSITIONING OF TRANSCIEVER AND WIRELESS WATER CONTROLLERS	31
HORIZONTAL FLUE TERMINAL CLEARANCES	32
HORIZONTAL OBSTRUCTIONS	33
MULTIPLE INSTALLATIONS	33
APPLIANCE DIMENSIONS	33
TRANSCIEVER INSTALLATION	34
MOUNTING & CONNECTING THE TRANSCIEVER	34
SETTING THE MAXIMUM TEMPERATURE AT THE TRANSCIEVER	34
INSTALLING WIRELESS WATER CONTROLLERS	34
WIRELESS WATER CONTROLLER INSTALLATION	35
INSTALLING MULTIPLE WIRELESS WATER CONTROLLERS	35
TROUBLE SHOOTING WIRELESS WATER CONTROLLERS CHANNEL ASSIGNMENT	36
UN-ASSIGNING AND RESETTING WIRELESS WATER CONTROLLERS	36
INSTALLING WIRED AND WIRELESS WATER CONTROLLERS	36
MOUNTING THE WIRELESS WATER CONTROLLER	37
WIRED WATER CONTROLLER INSTALLATION	38
RINNAI WATER CONTROLLERS	38
POSITIONING OF WATER CONTROLLERS	38
WATER CONTROLLER CABLES	38
FITTING THE 'UNIVERSAL' WATER CONTROL (MC-91Q)	38
OPTIONAL PROGRAMMING FOR THE 'UNIVERSAL' WATER CONTROLLER (MC-91Q)	39
FITTING THE 'DELUXE KITCHEN' WATER CONTROLLER (MC-100V)	40
FITTING THE 'DELUXE BATHROOM' WATER CONTROLLER (BC-100V)	40
COMMISSIONING	41
TESTING	41
DELIVERY TEMPERATURE	41
GAS PRESSURE SETTING	42
COMMISSIONING CHECK LIST	42
ACCESSORIES	42
PRODUCT RECORDS	42
CONTACT INFORMATION	44

GENERAL INSTALLATION INSTRUCTIONS



Installation, Service and Removal **MUST BE** by an Authorised Person only.

AS/NZS 5601 was current at the time of printing but may have been superseded. It is the installer's responsibility to ensure current requirements are met.

Remove transit protection. Check for damage, if any is found **DO NOT** install and contact supplier.

REGULATIONS

This appliance must be installed in accordance with:

- Current AS/NZS 3000, AS/NZS 3500 and AS/NZS 5601
- Rinnai Installation Instructions
- Local regulations and municipal building codes including local OH&S requirements

Installation, Service and Removal MUST BE by an Authorised Person only.

APPLICABLE MODELS

These Installation Instructions apply only to the following Rinnai Continuous Flow Water heater models are listed on the cover page of this manual.

APPLIANCE LOCATION

This appliance is designed for 'Outdoor' Installation only. As such, it must be located in an above ground open air situation with natural ventilation, without stagnant areas, where gas leakage and products of combustion are rapidly dispersed by wind and natural convection.

This appliance must be mounted on a vertical structure with the water and gas connections on the underside pointing downwards. For appliances installed on elevated structures or under floors specific requirements apply. Refer to AS/NZS 5601 Section 6 for details.

This appliance must not be used as a domestic spa or swimming pool heater.

Location of the appliance flue terminal must be in accordance with Section 6 and Figure 6.2 of AS/NZS 5601. Figure 6.2 is reproduced in the 'Horizontal Flue Terminal Clearances' section of these instructions.

This appliance must be placed as close as practicable to the most frequently used hot water outlet or outlets to minimise the delay time for hot water delivery. For installations where the distance between the water heater and the outlets is considerable, a flow and return system or the Rinnai Smartstart® system can be used which minimise the waiting time for hot water delivery.

Alternatively, multiple appliances can be strategically placed to serve outlets with minimal delay time. Contact Rinnai for further information.

An AC240V, 10 Amp, earthed power point must be provided adjacent to the appliance. For outdoor installations this power point must be weather proof. It must be clear of the gas and water connections to the appliance and also the flue exhaust and water pressure relief valve. The power cord of the appliance is 1.5 Metres long.

All appliances must be installed to ensure access can be gained without hazard or undue difficulty for inspection, repair, renewal or operational purposes. Sufficient clearances shall allow access to, and removal of, all serviceable components. Appliances should not be mounted higher than 2.5 metres above the ground or floor level unless the customer can arrange permanent and safe access or can provide another means of access, for example, by means of scissor or boom lifts acceptable to local authorities.

PIPE SIZING

See Table 1 page 30 for appliance gas consumption. If the gas pipe sizing is insufficient the customer will not get the full performance benefit. Gas pipe sizing must consider the gas input to this appliance as well as all the other gas appliances in the premises. The gas meter and regulator must be specified for this gas rate. An approved sizing chart such as the one in AS/NZS 5601 should be used.

Water pipe sizing and layout should be performed in accordance with AS/NZS 3500. All hot water pipe-work should be insulated to optimise performance and energy efficiency.

GENERAL INSTALLATION INSTRUCTIONS

WATER SUPPLY

See Table 1, page 30 for applicable water pressures. Approved pressure limiting valves may be required if the 'Maximum' rated water supply pressures in Table 1 are exceeded. To achieve the rated flow, the 'Minimum' water supply pressures in Table 1 must be supplied.

The water heaters will operate at lower pressures but will not achieve the rated flow. Contact Rinnai for 'gravity fed' or 'low pressure' installations.

Water chemistry and impurity limits are detailed under 'Warranty Conditions'. Most metropolitan water supplies fall within the requirements. If you are unsure about your local water quality, contact your water authority. If sludge or foreign matter is present in the water supply, a suitable filter or strainer should be incorporated in the water supply to the water heater.

HOT WATER DELIVERY TEMPERATURE

Local regulations and or the requirements of AS/NZS 3500 must be considered regarding the temperature limitations of hot water supplied to areas used primarily for personal hygiene. The temperature of water to these areas may be limited to 50°C or less. To ensure these regulations and or requirements are met the system MUST be installed in accordance with the 'Water Heater and Controller Installation Configurations' Section of these instructions.

WATER HEATER AND CONTROLLER INSTALLATION CONFIGURATIONS

If the appliance is marked to state that it delivers water not exceeding 50°C, local regulations may permit its installation without a Temperature Limiting Device. Installations without a Temperature Limiting Device are shown in Diagram 1 (page 29). If you are unsure about your local regulations contact your regulating authority or Rinnai.

If the appliance is **NOT** marked to state that it delivers water not exceeding 50°C, or your local regulations require installation with a Temperature Limiting Device then install the appliance in accordance with Diagram 2 (page 29).

Ensure that suitable fixing screws or bolts are used to secure the units to the wall, in accordance with AS/NZS 5601 section 6. Wooden plugs shall not be used.

The top bracket has a keyhole slot so that the appliance can be positioned by hanging it on one screw, then the other screws can be secured.

MOUNTING THE APPLIANCE

See Table 1, page 30 for individual appliance weights. The wall or structure on which the units are to be mounted must be capable of supporting these weights and the associated pipe-work.

The top bracket has a keyhole slot so that the appliance can be positioned by hanging it on one screw, then the other screws can be secured.

The appliance can be mounted directly against the wall or structure. There is no need to use, non combustible sheeting or leave an air gap between the appliance back panel and the wall or structure for the purposes of meeting the temperature hazard requirements of AS/NZS 5601.



If the appliance is to deliver water primarily for the purposes of personal hygiene in an early childhood centre, primary or secondary school, nursing home or a similar facility for the care of young, aged, sick or disabled persons as defined in AS/NZ 3500 a Temperature Limiting Device (TLD), such as a Tempering Valve may be required even if the appliance is set to 50° C or less.

For these types of applications contact Rinnai.

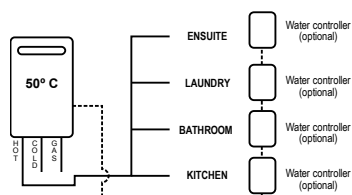

Diagram 1 - 50°C Appliance
Minimum length of pipe from hot outlet to nearest hot water tap 2 metres.

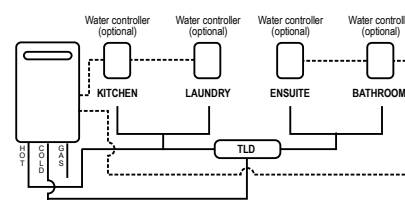

Diagram 2 - Not a 50°C Appliance
Note: TLD = Temperature Limiting Device

GENERAL INSTALLATION INSTRUCTIONS

SERVICE CONNECTION POINTS

See Table 1 for appliance connection / fitting dimensions.

An Approved full flow isolation valve and disconnection union **MUST** be fitted to the cold water inlet. A non return valve is not required unless required by local regulations.

Isolation Valves must not be fitted directly to the appliance.

If may be necessary to fit a temperature limiting device for delivery to areas used primarily for the purposes of personal hygiene. Refer to the 'Water Heater and Controllers Installation Configurations' Section of this document.

Purge gas and cold water supply lines to remove air and swarf before final connection of the appliance. Swarf in either the gas or water supplies may cause damage.

Model:	Gas Consumption MJ/h	Water Supply kPa		Weight kg	Fittings		
		Min.	Max.		Hot	Cold	Gas
REU-VRM2626WD	199	200	1000	16	R 3/4 (20mm)	R 3/4 (20mm)	R 3/4 (20mm)

Table 1.



Note that these dimensions are NOT an indication of the pipe sizes required.

RINNAI WIRELESS WATER CONTROLLERS

A wireless water controller installation utilises a 'transceiver' and up to 4 wireless water controllers. Unlike most remote control systems, there is 'two way' communication between the transceiver and controllers. The 'transceiver' is connected by electrical cable to the water heater. The 'transceiver' transmits control signals received from the wireless controllers operated by the user to the water heater. The 'transceiver' transmits operational 'status' signals from the water heater which are received by individual wireless controllers to ensure controller displays reflect the operational status of the water heater.

Wireless water controllers can be installed in conjunction with Universal and Deluxe wired water controllers and will function as described in the Operation Section of this manual. Refer to page 10 to confirm the maximum number and combination of water controllers that can be fitted.

Master and Sub controllers and temperatures

Only one wireless or wired controller can be designated the 'Master Controller' (MC). This controller is normally used in the kitchen and usually has a maximum temperature of 55°C, is sufficient for almost all kitchen applications. Temperatures higher than 55°C are possible but usually unnecessary and will result in higher gas use and increase the risk of burns. Some conditions regarding Master Controller maximum temperatures are as follows:

- Temperatures of 55°C or higher can only be selected on the controller designated as Master Controller (MC) if the transceiver 'Max Temp' is also programmed to 55°C or higher.
- The temperature of hot water delivered is always limited to the maximum temperature programmed into the water heater itself. For example, if the transceiver maximum temperature is programmed to 55°C and the water heater is limited to 50°C, the maximum temperature that the water heater will deliver is 50°C. In this case 55°C will be displayed on the wireless Master Controller until a tap is opened after which the display will revert to 50°C.



The water heater maximum temperature cannot be adjusted by the user.

These adjustments can only be carried out by a qualified and licensed tradesperson.

The remaining controllers are designated 'sub' controllers and are for use in bathrooms, toilets and laundries. The temperature limit for all 'Sub' controllers is always 50°C to minimise the risk of burns in these areas.

Adhesive labels are included for individual identification of wireless controllers as master (Kitchen) or sub (Bathroom No.) controllers. These labels are usually placed on the top back of the wireless water controller body.

GENERAL INSTALLATION INSTRUCTIONS



Other manufacturers water controllers are **NOT** compatible with Rinnai water heaters. Water controllers **MUST NOT** be used with any Solar Boost water heater. Rinnai water controllers brought in from other countries are not compatible with Rinnai appliances sold in Australia.

Regardless of water controller installation, all Rinnai water heaters must only be installed by an Authorised person.

Water controllers, transceivers and water heaters do not contain user serviceable parts and must only be serviced and repaired by an authorised person.

POSITIONING OF TRANSCIEVER AND WIRELESS WATER CONTROLLERS

The water controllers must be installed in shaded and clean locations. The water controllers and the transceiver should be fitted out of reach of children (suggested height from floor to be at least 1500 mm).

The water controllers are water resistant, however, durability is improved when positioned outside the shower recess. The water controllers must be installed at least 400 mm above the highest part of a sink, basin or bath.



The MC-503RC Wireless water controller is a water resistant device, however excessive exposure to water such as immersion may result in damage to the controller.

- **DO NOT** immerse the controller into water.
- **AVOID** direct exposure to water or steam as these conditions may cause a malfunction.
- **ALWAYS AVOID** exposure to water when the battery compartment is open.
- **When cleaning your water controller use ONLY** a damp cloth and a mild detergent.

The transceiver comes supplied with a 1.5m length of communications cable. The transceiver's antenna is located in the top. For the best results mount the transceiver so the top of the transceiver is higher than the top of the water heater.

In some cases building construction and design can reduce signal strength and it may be necessary to locate the transceiver in a central location inside the building. Take the signal strength into consideration when determining the best location for both the transceiver and the wireless water controllers.

GENERAL INSTALLATION INSTRUCTIONS

HORIZONTAL FLUE TERMINAL CLEARANCES

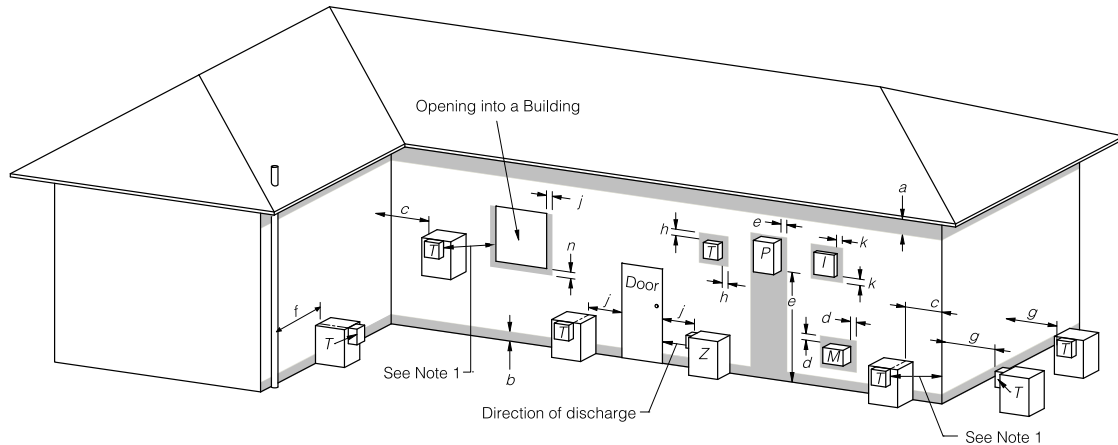

T = Flue terminal Z = Fan assisted flue appliance only M = Gas meter P = Electricity meter or fuse box I = Mechanical air inlet

■ Shading indicates prohibited areas for flue terminals

Ref.	Item	Min. Clearances (mm)
		Fan-Assisted
a	Below eaves, balconies and other projections:	
	• Appliances up to 50 MJ/h input	200
	• Appliances over 50 MJ/h input	300
b	From the ground, above a balcony or other surface *	300
c	Front a return wall or external corner *	300
d	From a gas meter (M) (see 5.11.5.9 for vent terminal location of regulator) (see Table 6.6 for New Zealand requirements)	1000
e	From an electricity meter or fuse box (P) †	500
f	From a drain pipe or soil pipe	75
g	Horizontally from any building structure* = or obstruction facing a terminal	500
h	From any other flue terminal, cowl, or combustion air intake †	300
j	Horizontally from an openable window, door, non-mechanical air inlet, or any other opening into a building with the exception of sub-floor ventilation:	
	• Appliances up to 150 MJ/h input *	300
	• Appliances over 150 MJ/h input up to 200 MJ/h input *	300
	• Appliances over 200 MJ/h input up to 250 MJ/h input *	500
	• Appliances over 250 MJ/h input *	1500
k	From a mechanical air inlet, including a spa blower	1000
n	Vertically below an openable window, non-mechanical air inlet, or any other opening into a building with the exception of sub-floor ventilation:	
	• Space heaters up to 50 MJ/hr input	150
	• Other appliances up to 50 MJ/hr input	500
	• Appliances over 50 MJ/h input and up to 150 MJ/h input	1000
	• Appliances over 150 MJ/h input	1500

* - unless appliance is certified for closer installation

† - Prohibited area below electricity meter or fuse box extends to ground level.

NOTES:

- Where dimensions c, j or k cannot be achieved an equivalent horizontal distance measured diagonally from the nearest discharge point of the terminal to the opening may be deemed by the Technical Regulator to comply.
- See Clause 6.9.4 for restrictions on a flue terminal under a covered area.
- See Figure J3 for clearances required from a flue terminal to an LP Gas cylinder. A flue terminal is considered to be a source of ignition.
- For appliances not addressed above acceptance should be obtained from the Technical Regulator.

FIGURE 6.2 (in-part) MINIMUM CLEARANCES REQUIRED FOR FAN-ASSISTED FLUE TERMINALS, ROOM-SEALED APPLIANCE TERMINALS AND OPENINGS OF OUTDOOR APPLIANCES

Extract from AS/NZS 5601

GENERAL INSTALLATION INSTRUCTIONS

HORIZONTAL OBSTRUCTIONS

AS/NZS 5601 'Gas Installations' stipulates a minimum horizontal clearance of 500 mm between a building structure and obstruction facing the terminal. For Rinnai external continuous flow water heaters such a building structure must 'obstruct' the full front cover height of the appliance, or extend vertically above and below the front cover. There must be no partial obstructions to the front cover of the appliance or any other parts of the appliance casing. This will avoid the appliance failing to operate under windy conditions.

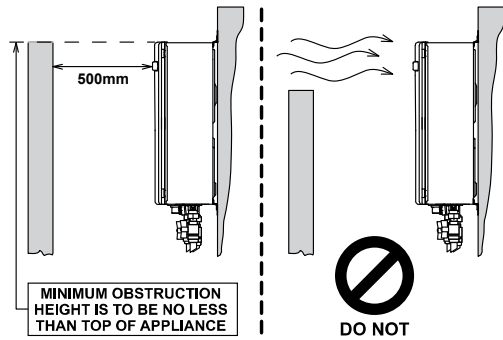

MULTIPLE INSTALLATIONS

Dimension 'h' above does not apply when multiple Rinnai external water heaters of the same model are installed on the same vertical face with flue terminals at the same height. Under these conditions appliances can abut each other as shown. The total gas consumption of all appliances applies when determining other clearances.

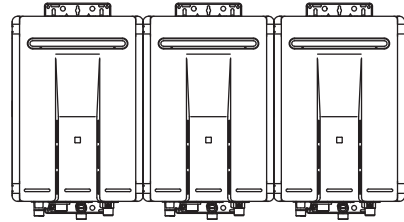

APPLIANCE DIMENSIONS

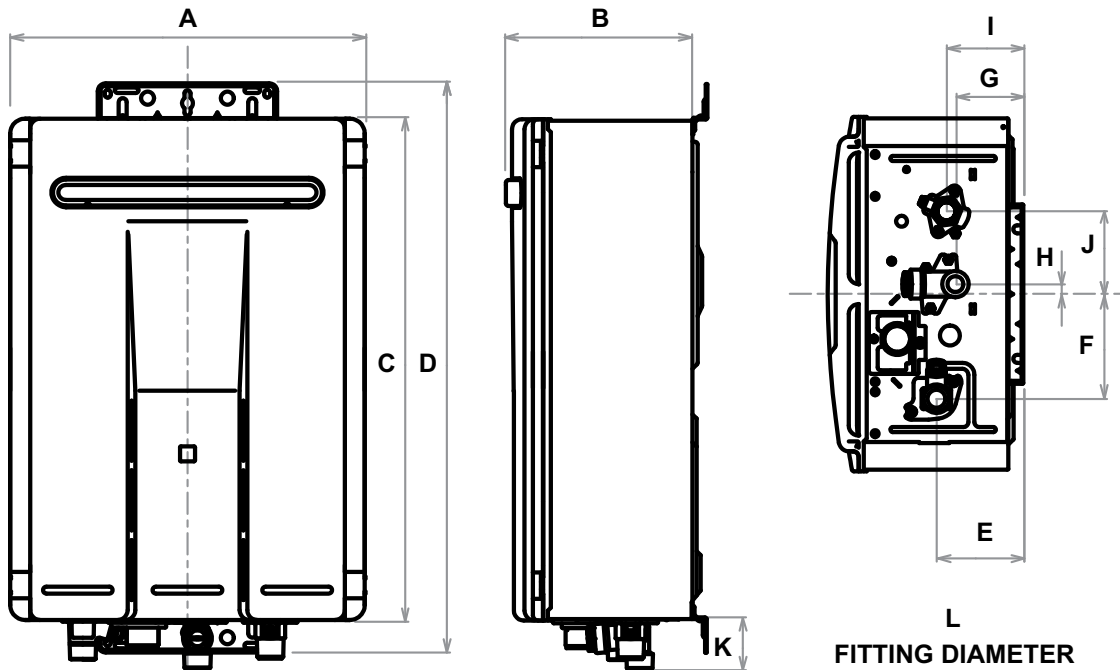

Dim'	Description	REU-VRM2626WD
A	Width	356
B	Depth	202
C	Height - Unit	503
D	Height - Including Brackets	571
E	Hot Water outlet (from wall)	87
F	Hot Water outlet (from centre)	105
G	Cold Water inlet (from wall)	68
H	Cold Water inlet (from centre)	10
I	Gas Connection (from wall)	77
J	Gas Connection (from centre)	83
K	Gas Connection Length (from base)	40
	Cold Connection Length (from base)	50
	Hot Connection Length (from base)	42
L	Gas: Fitting Diameter	20
	Cold: Fitting Diameter	20
	Hot: Fitting Diameter	20

TRANSCIEVER INSTALLATION

MOUNTING & CONNECTING THE TRANSCIEVER



- The distance between the water heater and the transceiver must not exceed 20m.
- Metallic structures, appliances or magnetic fields in the vicinity of transceiver or wireless water controllers may reduce signal strength.
- Do not install transceiver near a heat source, such as a cook top, stove or oven. Heat, steam, smoke and hot oil may cause damage.
- The transceiver **MUST NOT** be installed where chemicals such as benzene, alcohol, turpentine, hydrogen sulphide, ammonia, chlorine or similar chemicals are in use.

1. Determine the most suitable position for the transceiver (see "POSITIONING OF TRANSCIEVER AND WIRELESS WATER CONTROLLERS" on page 31).
2. The transceiver can be either be mounted under the hot water unit via the lower bracket or to the wall using the screws and/or anchors provided as shown.
3. Connect the communication cable plug **A**. of the transceiver to the communication cable socket **B**. of the hot water unit.

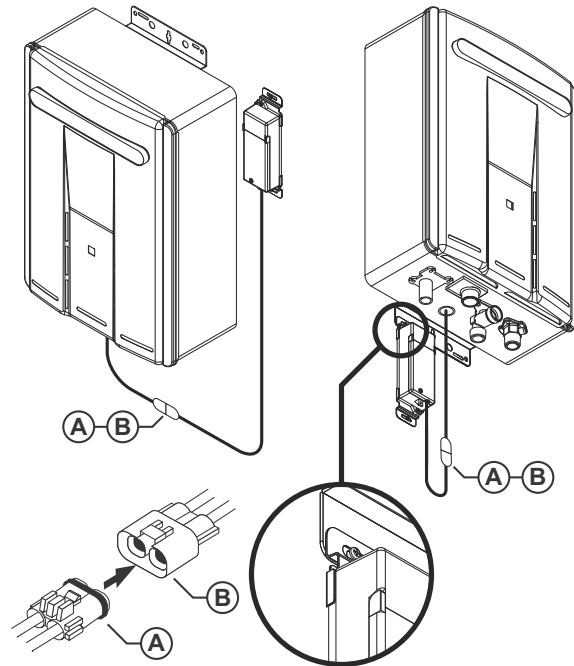

SETTING THE MAXIMUM TEMPERATURE AT THE TRANSCIEVER

1. Ensure the power to the water heater is switched 'on'.
2. Set the transceiver's maximum water temperature to 55°C by pressing the 'Max Temp' button until 55 is displayed.

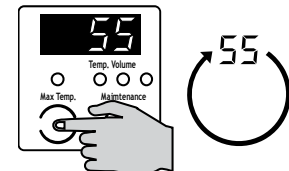

Refer to "Master and Sub controllers and temperatures" on page 30 for information regarding using of the maximum temperatures with wireless water controllers.

INSTALLING WIRELESS WATER CONTROLLERS



This installation procedure applies to wireless water controller installations only. For combined wired and wireless water controller installations refer to "INSTALLING WIRED AND WIRELESS WATER CONTROLLERS" on page 36.

Up to 4 wireless water controllers can be installed. Only one of these can be designated as a 'Master Controller' (MC), others will be designated as 'Sub Controllers'.

Only one wireless water controller can be installed at a time. **DO NOT** insert batteries until step 3.

The supplied wireless water controller is pre-designated as a 'Master Controller' (MC) by default and as such is ready for a kitchen installation out of the box.

If the preferred installation location for the controller is to be a bathroom, ensuite, etc then the controller will need to be re-assigned as a 'Sub' controller, see "UN-ASSIGNING AND RESETTING WIRELESS WATER CONTROLLERS" on page 36 for details how to re-assigned as a controller.

WIRELESS WATER CONTROLLER INSTALLATION

1. Ensure the power to the water heater is switched 'on'.
2. Press the 'Entry' button **a** on the transceiver for approximately 2 seconds to select a wireless controller channel for tuning. The first unassigned wireless controller channel LED will begin a fast flash, signifying that this channel has been selected for tuning.

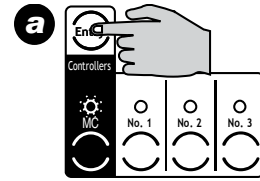

The default order of channel selection is as follows: → MC → No. 1 → No. 2 → No. 3 →
The wireless Master Controller is the only wireless controller capable of selecting maximum delivery Temperatures exceeding 50°C. Ensure that the Master Controller (Kitchen) label provided is placed on the top rear of the assigned controller.

3. Select a wireless water controller for tuning to the unassigned transceiver channel and remove the controller from it's wall mounting bracket. Open the battery compartment with a full turn anti-clockwise. Insert the batteries observing the correct polarity. Close the battery compartment with a full turn clockwise **b**

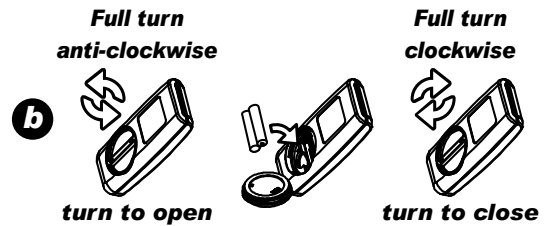

4. After battery installation the wireless controller will momentarily display an initialisation screen **(A)**, which will then switch to screen **(B)** or **(C)**.
5. If screen **(B)** is displayed press and hold the 'On/Off' \odot button until screen **(C)** is displayed. This takes approximately 2 seconds.
6. From screen **(C)** press the 'On/Off' \odot button once to start the tuning process which will take approximately 5 seconds. Once the controller is tuned the controller channel LED on the transceiver will become steady and the controller LCD will switch to screen **(D)** or **(E)**.
7. From screen **(D)** press the 'On/Off' \odot button once or from screen **(E)** press the 'Transfer' $\triangleleft \triangleright$ button once to complete the tuning of this channel. At this point screen **(F)** will be displayed by the controller. The wireless water controller is now tuned and ready to control the delivery temperature of the water heater.
8. Apply one of the self-adhesive identification stickers to the rear of the controller, ensuring that the Master Controller sticker is only applied to the wireless water controller tuned to channel MC.

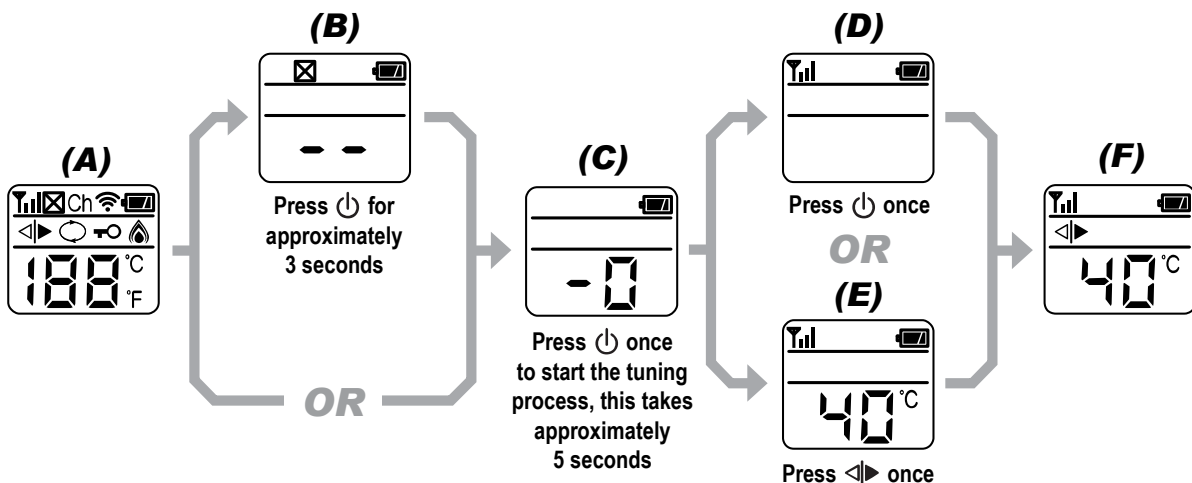

INSTALLING MULTIPLE WIRELESS WATER CONTROLLERS

To install subsequent wireless water controllers repeat steps 2 to 8 for each additional wireless water controller.

Once all wireless water controllers are installed re-secure the transceiver access cover.

WIRELESS WATER CONTROLLER INSTALLATION

TROUBLE SHOOTING WIRELESS WATER CONTROLLERS CHANNEL ASSIGNMENT

If at the end of the installation process screen (C) is displayed do the following:

Confirm first that the power is still on at the water heater.

If power is off turn it back on. If the channel has been correctly assigned then the display should show either screens (E), (F) or (G).



If screen (C) is still displayed un-install and reset the wireless controller and repeat the installation procedure.

(C)

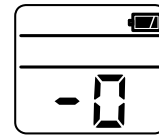

(E)

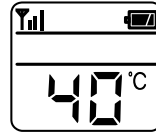

(F)

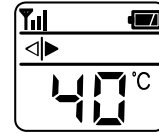

(G)

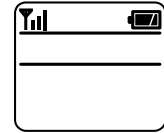

UN-ASSIGNING AND RESETTING WIRELESS WATER CONTROLLERS

1. Press the desired controller channel button **(c)**. The LED will go out to signify that this channel is now un-assigned.
2. Removing the batteries **(d)** from the wireless controller will reset the wireless controller and complete the un-install process.

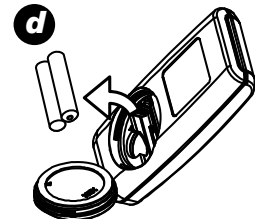
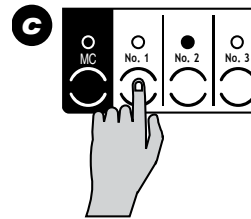

INSTALLING WIRED AND WIRELESS WATER CONTROLLERS



As supplied the water heater is not pre-wired for the installation of wired controllers or smartstart systems, however it can be modified to do so, contact Rinnai for the parts and procedures to enable these options.



When installing combinations of both wired and wireless controllers, all wired water controllers MUST BE connected before the wireless water controllers are assigned to a transceiver channel.

Refer to page 10 to confirm the maximum number and combination of water controllers that can be fitted

Wired water controllers can ONLY be added to an existing wireless installation when:

- All wireless transceiver channels have been un-assigned.
- All wireless controllers have been reset.

See "UN-ASSIGNING AND RESETTING WIRELESS WATER CONTROLLERS" above.

When the wireless transceiver is installed it automatically detects any wired water controllers already connected to the water heater.

The LEDs of the channels assigned to wired controllers **(e)** will slow flash. The channels for wired water controllers are assigned in sequence as follows:

MC100V or MC91 (programmed as a Master Controller) will automatically be assigned to the MC channel.

BC100V or MC91 (not programmed as a Master Controller) will automatically be assigned to an available channel other than the MC channel.

Install the wireless water controllers to any of the unassigned channels following steps 1 to 8 on page 35.

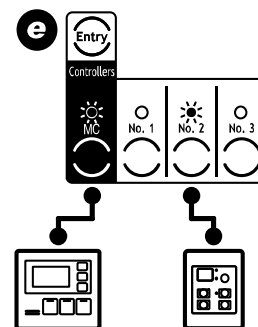



WIRELESS WATER CONTROLLER INSTALLATION

MOUNTING THE WIRELESS WATER CONTROLLER



- Metallic structures, appliances or magnetic fields in the vicinity of transceiver or wireless water controllers may reduce signal strength.
- Do not install wireless water controllers near a heat source, such as a cook top, stove or oven. Heat, steam, smoke and hot oil may cause damage.
- Do not install wireless water controllers in direct sunlight.
- Do not install wireless water controllers outdoors unless protection from dust ingress and sunlight are provided.
- Wireless water controllers **MUST NOT** be installed where chemicals such as benzene, alcohol, turpentine, hydrogen sulphide, ammonia, chlorine or other similar chemicals are in use.

1. Determine the most suitable position for the water controller (see "POSITIONING OF TRANSCEIVER AND WIRELESS WATER CONTROLLERS" on page 31).

The 'Signal Strength'  indicator displays one of four levels. ◀ **Strong**  **Weak** ▶

The 'Out Of Range'  indicator displays when the wireless water controller is out of range of the transceiver or when an object is obstructing the radio signal.

Wireless water controllers should be positioned such that the signal strength indicator displays at least '2 bars' next to the antenna symbol  during installation. Signal strength varies with atmospheric and other conditions. If the signal strength is weaker than '2 bars' during installation, there may be other times when the signal is too weak to allow operation.

2. Slide the wireless water controller from its' wall mounting bracket.
3. Use the wall mounting bracket as a template to mark off and drill 2 holes for use with mounting fixings.
4. Secure the wall mounting bracket to the wall with the screws and or anchors provided. Avoid over-tightening of fixings as this may cause damage. DO NOT use powered tools to tighten fixings.
5. Slide the wireless water controller back into its' wall mounting bracket.

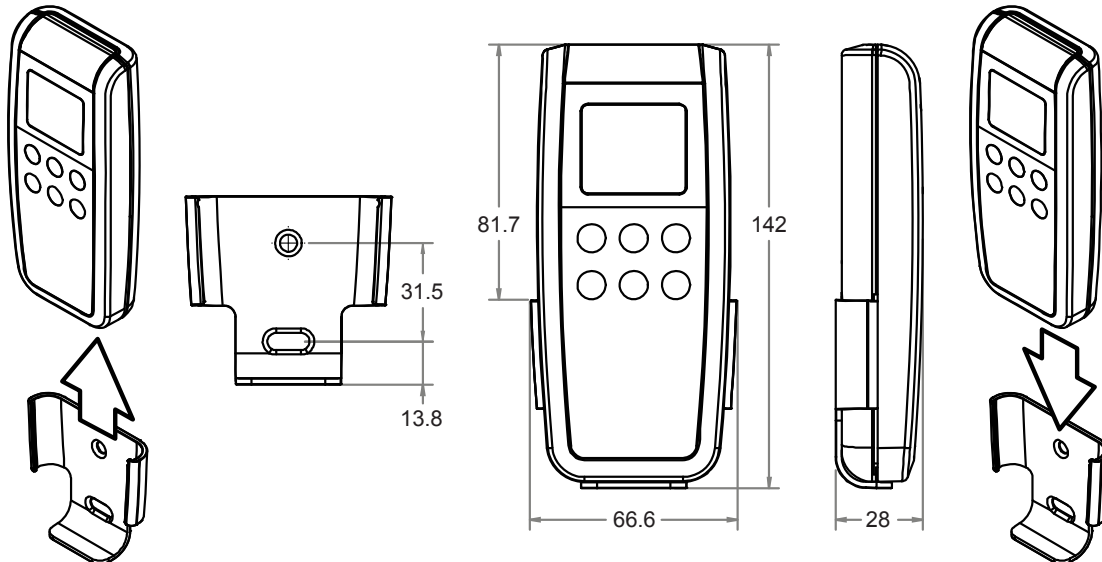

ADDITIONAL WATER CONTROLLER MOUNTING CONSIDERATIONS.

The MC-503RC uses a Liquid Crystal Display (LCD) for the digital monitor. Light reflections can make the LCD difficult to see at direct eye level.

For best results when installing the MC-503RC mount the water controller lower than your eye-level to avoid these light reflections.

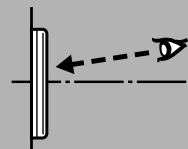

WIRED WATER CONTROLLER INSTALLATION

RINNAI WATER CONTROLLERS



As supplied the water heater is not pre-wired for the installation of wired controllers or smartstart systems, however it can be modified to do so, contact Rinnai for the parts and procedures to enable these options.

Water controllers are available as an optional extra. Universal and Deluxe water controllers can be used together and will function as described in the Operation Section of this manual. Please refer to page 10 to confirm the maximum number and combination of water controllers that can be fitted.



Other manufacturers water controllers are NOT compatible with Rinnai water heaters. Water controllers MUST NOT be used with any Solar Boost water heater. Rinnai water controllers brought in from other countries are not compatible with Rinnai appliances sold in Australia.

POSITIONING OF WATER CONTROLLERS

Water controllers must be installed in shaded and clean locations. They should be fitted out of reach of children (suggested height from floor to be at least 1500 mm). BC-100V water controllers are water resistant, however, durability is improved when positioned outside the shower recess. All deluxe water controllers must be installed at least 400 mm above the highest part of a sink, basin or bath.



- Do not install water controllers near a heat source, such as a cook top, stove or oven. Heat, steam, smoke and hot oil may cause damage.
- Do not install water controllers in direct sunlight.
- The MC-100V water controller MUST NOT be installed in a bathroom.
- Do not install water controllers outdoors unless protection from dust ingress and sunlight are provided.
- Do not install water controllers against a metal wall unless the wall is earthed in accordance with AS/NZS 3000.
- Water controllers MUST NOT be installed where chemicals such as benzene, alcohol, turpentine or other similar chemicals are in use.

POSITIONING CONSIDERATIONS FOR THE MC-100V WATER CONTROLLER.

The MC-100V uses a Liquid Crystal Display (LCD) for the digital monitor. Light reflections can make the LCD difficult to see at direct eye level.

For best results when installing the MC-100V mount the water controller lower than your eye-level to avoid these light reflections.

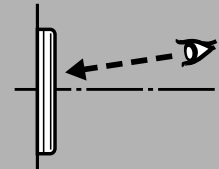

WATER CONTROLLER CABLES

Water controllers operate at extra low voltage (12 Volts DC) which is supplied from the water heater. Each Water controller comes supplied with 15 m of electrical cable. The appliance end of the cables are fitted with spade terminals. Extension cabling is available from Rinnai.



Alternatively two core sheathed (double insulated) flex with minimum cross-sectional area of 0.5 mm² may be used. Maximum individual cable runs should not exceed 50 m.

FITTING THE 'UNIVERSAL' WATER CONTROLLER (MC-91Q)

1. Determine the most suitable position for the water controller.
2. Mark and drill 3 holes, locating the cable access as shown in (Fig. 1).
3. When running cable through the access hole ensure the connector end of the cable is located nearest to the controller (Fig. 2).
4. Carefully remove face plate from the water controller, using a screw driver (Fig. 3).
5. Connect the cable to the water controller. Feed any excess cable lengths into the wall cavity to avoid the pinching of cables between the wall and the controller.
6. Fix the water controller to the wall using the appropriate fixings as shown in (Fig. 4).

WIRED WATER CONTROLLER INSTALLATION

7. Remove protective film from the water controller face as shown in (Fig. 4) and replace face plate.

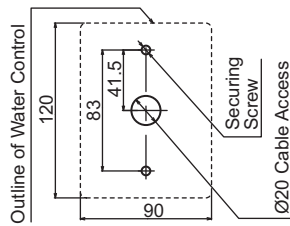

Fig. 1

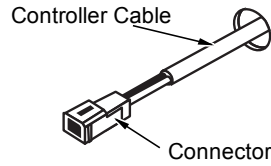

Fig. 2

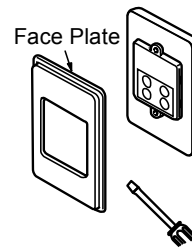

Fig. 3

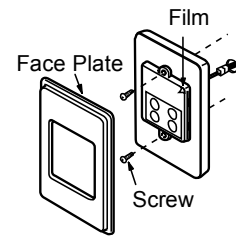

Fig. 4

OPTIONAL PROGRAMMING FOR THE 'UNIVERSAL' WATER CONTROLLER (MC-91Q)



1 Are there four water controllers connected?

IF NO: (You have three water controllers or fewer), go to Question 2.

IF YES: You will need to activate the fourth water controller as follows:

STEP 1: For the water controller in the KITCHEN ONLY, press and hold the 'Transfer' and 'On/Off' buttons simultaneously (see Fig. 5) until a 'beep' is heard (approximately 5 seconds).

STEP 2: Check that the display on ALL FOUR water controllers is lit and displaying a temperature when 'switched on'. If any ONE of the controller displays two dashes (see Fig. 6) repeat STEP 1.

This completes the activation procedure for the fourth controller, you may ignore Question 2.

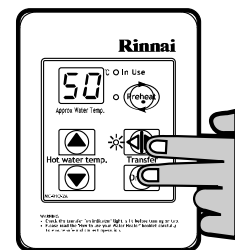

Fig. 5



Fig. 6



2 Is the water heater marked to state it delivers water not exceeding 50°C?

IF YES: No further action required.

IF NO: You will need to program the kitchen controller to enable selection of temperatures higher than 50°C.

STEP 1: For the controller in the KITCHEN ONLY, press and hold the 'Transfer' and 'On/Off' buttons simultaneously (Fig. 7) until a 'beep' is heard (approximately 5 seconds).

STEP 2: When the controller fitted in the KITCHEN is switched On, it should be possible to select temperatures higher than 50°C. If not, repeat STEP 1.

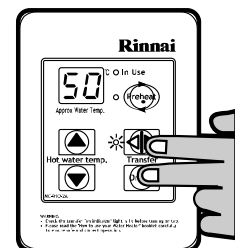

Fig. 7



If the water controller in the kitchen is replaced, repeat STEP 1 above for the replacement controller.

If the water controller in the kitchen is swapped with another controller (for example, the controller fitted in a bathroom), repeat STEP 1 for the controller moved from the kitchen to the bathroom. Then perform STEP 1 for the controller moved from bathroom to the kitchen.

FITTING THE 'DELUXE KITCHEN' WATER CONTROLLER (MC-100V)

WIRED WATER CONTROLLER INSTALLATION

1. Determine the most suitable position for the water controller (see notes page 38).
2. Use the wall mounting bracket as a template to mark and drill 3 holes, locating the cable access as shown in (Fig. 1).
3. Fix the mounting bracket to the wall using the appropriate fixings.
4. Run the cable through the hole in the wall.
5. Carefully remove face plate from the water controller, using a screw driver (Fig. 2).

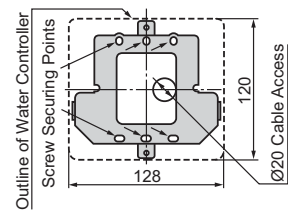

Fig.1

6. Connect the cable to the water controller as shown in (Fig 3). At this point cables from other controllers (if fitted) may also be connected to the screw terminals of the Kitchen water controller (Fig. 4) eliminating the need for multiple cable runs directly to the water heater. Water controllers are not polarity sensitive. Feed any excess cable lengths into the wall cavity to avoid the pinching of cables between the wall and the controller.
7. Fasten the controller to the wall mounting bracket as shown in (Fig. 5). Avoid the over-tightening of fixings as this may cause damage. Once secured replace the face plate.

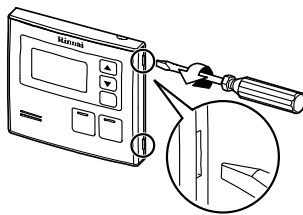

Fig. 2

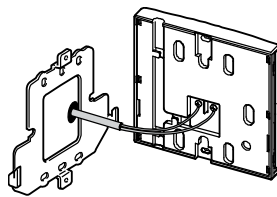

Fig. 3

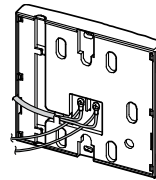

Fig. 4

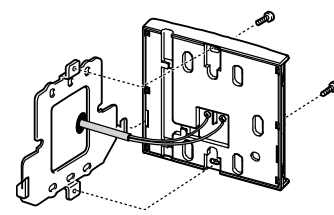

Fig. 5

FITTING THE 'DELUXE BATHROOM' WATER CONTROLLER (BC-100V)

1. Determine the most suitable position for the water controller (see notes page 38).
2. Mark and drill 3 holes, locating the cable access as shown in (Fig. 1).
3. When running a cable through the access hole ensure the connector end of the cable is located nearest to the controller (Fig. 2).
4. Affix the double sided self-adhesive seal to the back of the water controller (Fig. 3).
5. Carefully remove the face plate from the water controller, do this by placing your thumbs on the front of the digital display and while hooking your fingers behind top of plate and gently push as shown in (Fig. 4), DO NOT use a screwdriver as this may damage the controller.
6. Connect the cable to the water controller. Feed any excess cable lengths into the wall cavity to avoid the pinching of cables between the wall and the controller.
7. Fix the controller to the wall using the appropriate fixings as shown in (Fig. 5), avoid over-tightening of fixings as this may cause damage. Once secured replace the face plate.

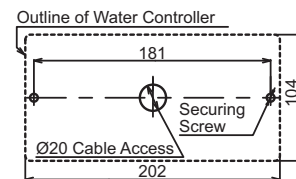

Fig. 1

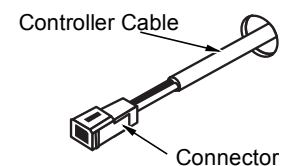

Fig. 2

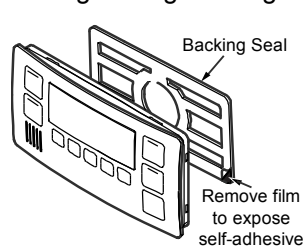

Fig. 3

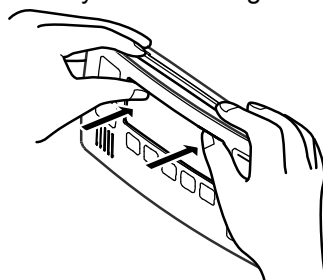

Fig. 4

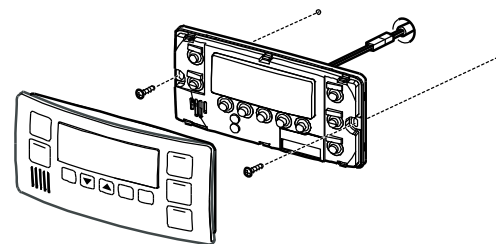

Fig. 5

COMMISSIONING

TESTING

1. Before final connection of the water heater purge gas, hot water and cold water supply lines. Swarf in either the gas or water supplies may cause damage.
2. Turn on gas and cold water supplies.
3. Test for water leaks and gas escapes near the unit.
4. Isolate gas supply. Remove test point screw located on the gas inlet connection and attach pressure gauge.
5. Turn the power 'on' at the power point socket and turn on gas.
6. Ensure controllers are 'ON', select the maximum delivery temperature and open ALL available hot water taps including the shower. If water controllers are not fitted, simply open all available hot water taps. (CAUTION: Ensure building occupants do not have access to hot water outlets during this procedure.)
7. Operate ALL other gas appliances at their maximum gas rate, in accordance with manufacturers instructions.
8. With all gas appliances in operation at maximum gas rate, the pressure should read between 1.13 - 3.0 kPa on Natural Gas. On LPG the pressure should be 2.75 - 3.0 kPa. If the pressure is lower, the gas supply is inadequate and the appliance will not operate to specification. It is the Installers responsibility to check the gas meter, service regulator and pipe work for correct operation/sizing and rectify as required. Note that the gas regulator on the appliance is electronically controlled and factory pre-set. Under normal circumstances it DOES NOT need adjustment during installation.
9. Close hot water taps including the shower.
10. Inspect and clean the strainer located on the cold water inlet connection. This procedure may need to be repeated to ensure the strainer remains clear, especially on new installations.
11. If water controllers are fitted, it is necessary to test their operation through the complete range of functions (refer to the Operation sections of this manual).
12. Confirm the hot water delivery temperature(s) using a thermometer. If controllers are fitted, ensure temperatures exceeding 50°C cannot be selected on bathroom or ensuite controllers. Refer to the section 'Delivery Temperature' below for more details.
13. After testing is completed, explain to the householder the functions and operation of the water heater and water controllers (if fitted). Ensure the "PRODUCT RECORDS" on page 42 of this manual is filled in and that the booklet is handed to the customer. Reminding the customer to complete the Warranty Card and forward to Rinnai.

DELIVERY TEMPERATURE

"50°C Compliant" appliances are 'factory set' to deliver a maximum temperature not exceeding 50°C. However, they have an incremental adjustment mechanism that allows the installer to increase the appliance delivery temperature incrementally from the 'Factory Set' value to temperatures exceeding 50°C. This is intended to enable compensation for temperature losses in the pipe-work between the water heater and any outlets and achieve the required temperature at the outlet. Instructions for incremental temperature adjustment are located in the instruction pocket inside the appliance front cover.

For all other models

Rinnai continuous flow water heaters are factory pre-set to various maximum delivery temperatures depending on model and their intended application. For the majority of applications, the factory pre-set temperature is appropriate. In the unlikely event it is not this setting can be increased or decreased by the installer. Instructions for changing the maximum delivery temperature are located in the instruction pocket inside the appliance front cover.

COMMISSIONING

GAS PRESSURE SETTING

The regulator is electronically controlled and factory pre-set. Under normal circumstances it does not require adjustment during installation.

Make adjustments only if the unit is not operating correctly and all other possible causes for incorrect operation have been eliminated.

Instructions for gas pressure setting are located in the instruction pocket inside the appliance front cover.



For all injector size and gas pressure values refer to the appliance data plate, located on the left hand side of the water heater.

COMMISSIONING CHECK LIST

A commissioning check list is provided on the appliance front cover to enable the installer to step through the correct commissioning procedure when installing a Rinnai Continuous Flow water heater.

The check list can also assist the installer to identify potential installation errors that may prevent the appliance from operating correctly.

Wiring Diagram

The wiring diagram is located in the instruction pocket inside the appliance front cover.

ACCESSORIES

Recess Box:

These allow the appliance to be recessed into the cavity of the wall saving precious space. Suitable for painting.

Security Cage:

Protect the gas booster unit from theft and damage.

Security Bracket:

Prevent theft of the gas booster by securing it with the custom security bracket.

Sideways Flue Diverter

Designed to redirect flue products when the gas booster is installed on a balcony.

Contact Rinnai for further information about our accessory range and model suitability details.

PRODUCT RECORDS

Please take a moment to record the following information below for your own records.

Model No:	REU- _____	Serial No:	_____
Your Retailer:	_____		
Address:	_____		
Contact Number:	() _____		
Purchase Date:	_____ / _____ / _____		
Your Installer:	_____		
Address:	_____		
Installers License No.:	_____		
Contact Number:	() _____		
Installation Date:	_____ / _____ / _____		
Certificate of Compliance No.:	_____		

NOTES



Rinnai Australia Pty Ltd
ABN 74 005 138 769

100 Atlantic Drive, Keysborough,
Victoria 3173

P.O. Box 460,
Braeside, Victoria 3195

Tel: (03) 9271 6625
Fax: (03) 9271 6622

National Help Line

Tel: 1300 555 545*
Fax: 1300 555 655*

*Cost of a local call higher from mobile
or public phones.

Hot Water Service Line

Tel: 1800 000 340

For further information visit
www.rinnai.com.au
or email **enquiry@rinnai.com.au**



060 00012 39897 7

U298-1430(00)

14.02.00 

Rinnai has a Service and Spare Parts network with personnel who are fully trained and equipped to give the best service on your Rinnai appliance. If your appliance requires service, please call our National Help Line. Rinnai recommends that this appliance be serviced every 3 years.

Rinnai

Relax. It's a Rinnai.