

Wi-Fi Enabled Deadbolt with Keypad

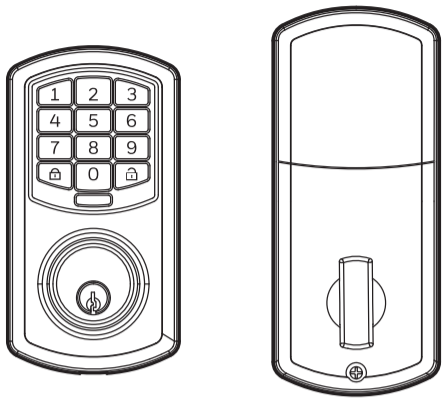

Package Includes:

- | | | |
|------------------------|--------------------|------------------------|
| 1 - Exterior Faceplate | 1 - Strike Plate | 2 - 5/16" Screws |
| 1 - Interior Faceplate | 1 - Mounting Plate | 2 - 1" Screws |
| 1 - User Guide | 1 - Latch | 4 - 3/4" Screws |
| 2 - Keys | 1 - 1 3/8" Screws | 1 - Optional Set Screw |

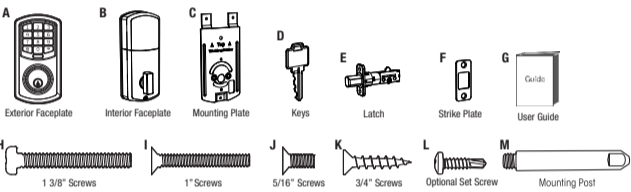

Please carefully check the above list to confirm all items have been received. If any items are missing, please contact Consumer Assistance. (See page for contact information)

Read this manual carefully before installing and operating!

Model 1743010 1743011

1 Installation Overview

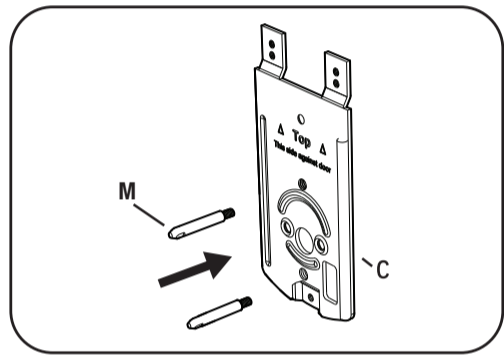
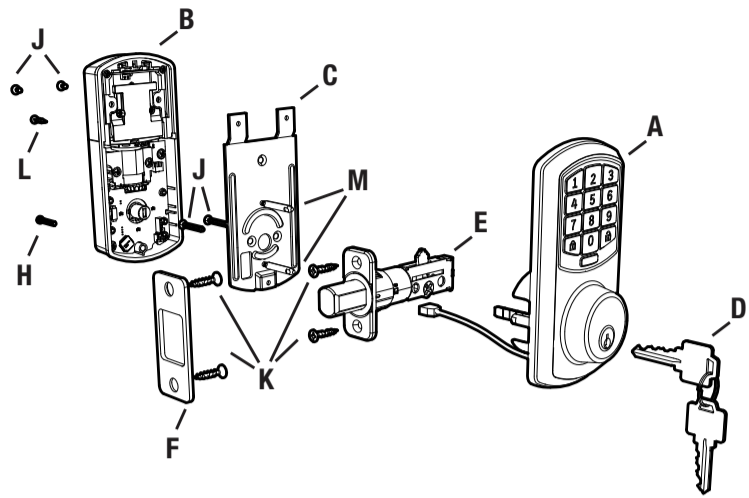

NOTE: Screw Mounting Post (L) into holes on Mounting Plate (C)

5 Install Interior Assembly

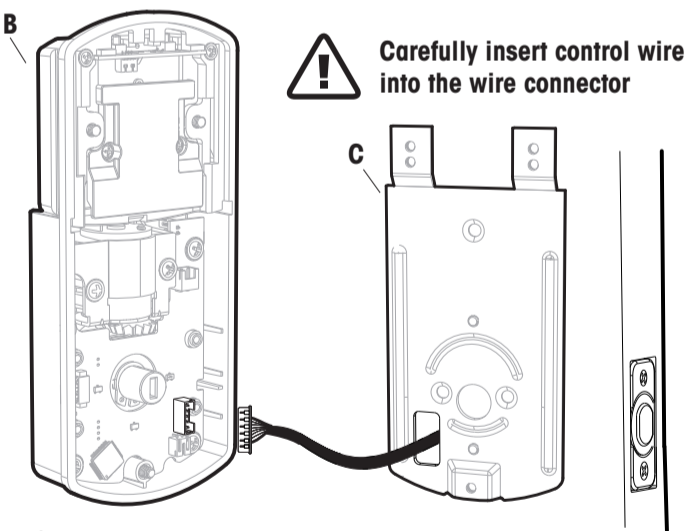

! Work with the door open

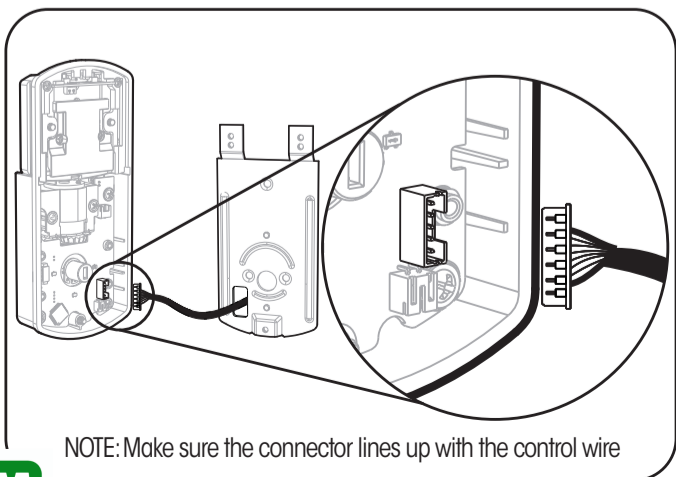

NOTE: Make sure the connector lines up with the control wire

6 Install Interior Assembly

NOTE: Make sure the Knob is in the **Vertical** position. Be careful not to pinch the control wire when assembling. Feed excess wire back into the slot.

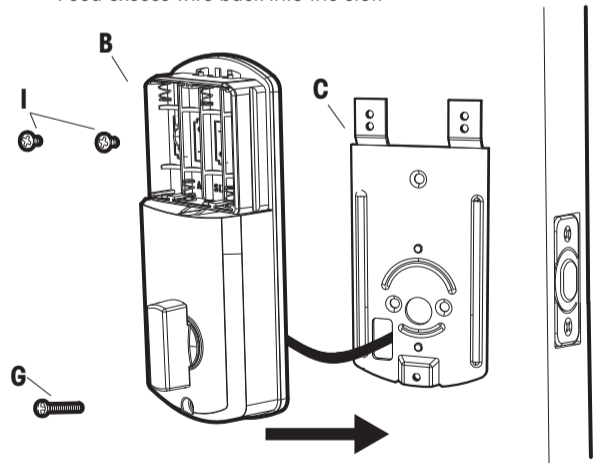

Test the lock

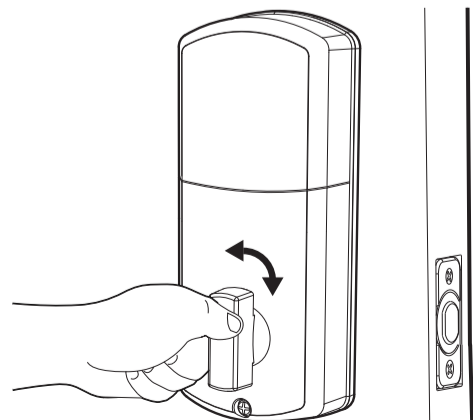

Lock and unlock using the knob make sure the latch is opening and closing easily. If not, go back to step 2 and ensure you followed the steps correctly



2 Preparing Door

NOTE: Skip this step if your door comes with pre-drilled holes.

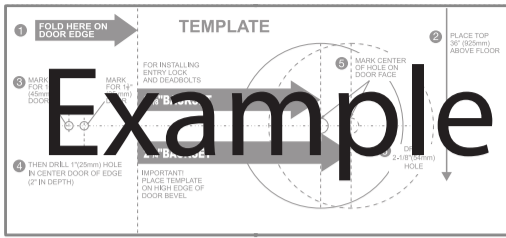

Refer to Template for Door Prep Instructions

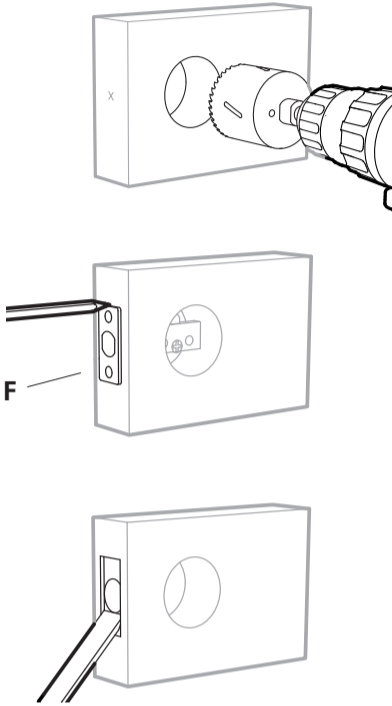

3 Install Enclosed Latch and Strike Plate

NOTE: Do not extend Cylindrical Cover past 2-3/4" (70mm)

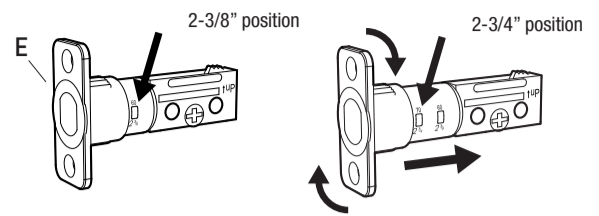

TO CONVERT FROM 2-3/8" (60mm) BACKSET TO 2-3/4" (70mm) BACKSET

1. Hold latch with numbers facing forward and thumb pressing on the bolt.
2. Rotate the cylinder cover clockwise.
3. Pull and twist the extension plate all the way out.
4. Rotate the cylinder counter clockwise so that the marking aligns with the 2-3/4" position indicator.

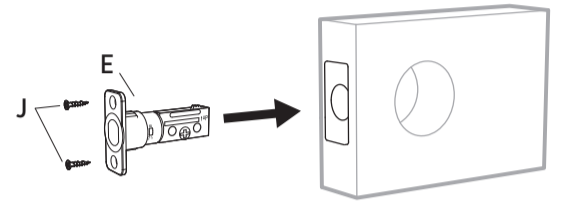

Strike Plate

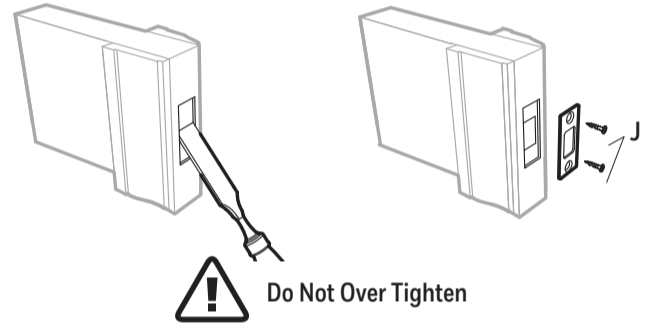

7 Install Batteries and Cover

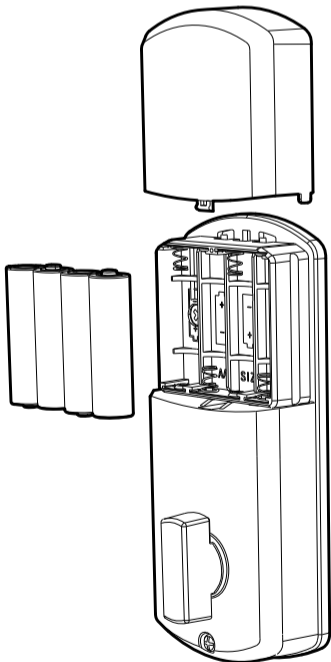

This Electronic lock requires (4) High Quality AA Alkaline batteries. When all 4 batteries are installed in the correct position, you should hear 2 beeps and the keypad will illuminate.

The Lock motor will engage and do a series of locking and unlocking motions in order to automatically determine your door "Handing" (left or right handed door). The lock will beep and the keypad will flash signaling success.

NOTE: Do not touch the Keypad until the light turns off. Do not use rechargeable batteries or non-alkaline batteries.

8 Testing Operation

Test the lock button with door open

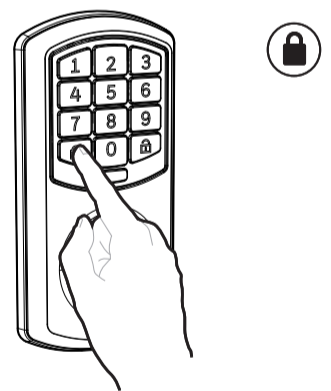

Test unlocking

Press 1-2-3-4-5-6-



Before Opening Door Let Motor Complete Cycle

Note: Let lock operation complete before attempting another action

4 Install Exterior Assembly

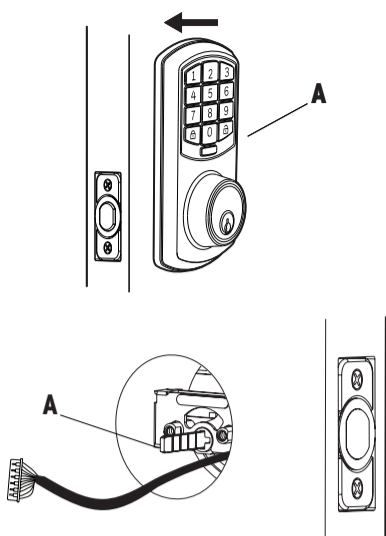

Check that the Rubber Gasket is secured on the Exterior Assembly. Insert the Exterior Assembly onto the door with the tailpiece going through the Deadbolt Latch Set in the **VERTICAL POSITION and the Latch Retracted**. Route the Control Wire through the door under the Deadbolt Latch Set.

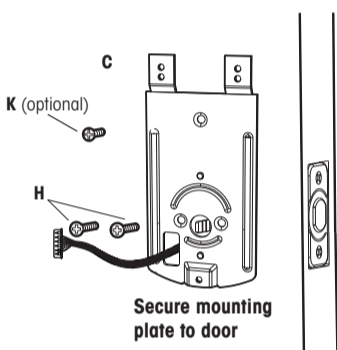

Regulatory Compliance

This product complies with standards established by following regulatory bodies:
- Federal Communications Commission (FCC)

FCC WARNING:

Warning: Changes or modifications to this unit not expressly approved by the party responsible for compliance could void the user's authority to operate the equipment.

FCC STATEMENT

NOTE: This equipment has been tested and found to comply with the limits for a Class B digital device, pursuant to Part 15 of the FCC Rules. These limits are designed to provide reasonable protection against harmful interference in a residential installation. This equipment generates uses and can radiate radio frequency energy and, if not installed and used in accordance with the instructions, may cause harmful interference to radio communications.

However, there is no guarantee that interference will not occur in a particular installation. If this equipment does cause harmful interference to radio or television reception, which can be determined by turning the equipment off and on, the user is encouraged to try to correct the interference by one or more of the following measures:

- Reorient or relocate the receiving antenna.
- Increase the separation between the equipment and receiver.
- Connect the equipment into an outlet on a circuit different from that to which the receiver is connected.
- Consult the dealer or an experienced radio/TV technician for help.

This equipment complies with FCC radiation exposure limits set forth for an uncontrolled environment. This equipment should be installed and operated with a minimum distance of 20cm between the radiator & your body. This transmitter must not be co-located or operating in conjunction with any other antenna or transmitter.

IMPORTANT! Changes or modifications not expressly approved by the manufacturer could void the user's authority to operate the equipment.

**Congratulations, You have Installed the
Trubolt Orion Wi-Fi Deadbolt
(1743010 1743011)
Turn Sheet over for Programing Instructions.**

M1743010 1743011 E V0

Programming Instructions



Download My Key Mobile Plus from the APP store or Google Play



1 Register an Account

1. Press "Sign up now" on the login screen
2. Enter your E-mail or press "Use a phone number" and preferred password

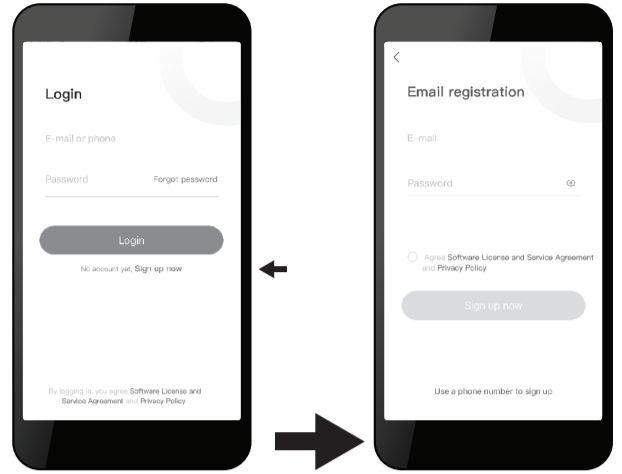

3. Enter the Verification code you received via E-mail or text
4. Success! Use the selected password to log into the My Key Mobile Plus App

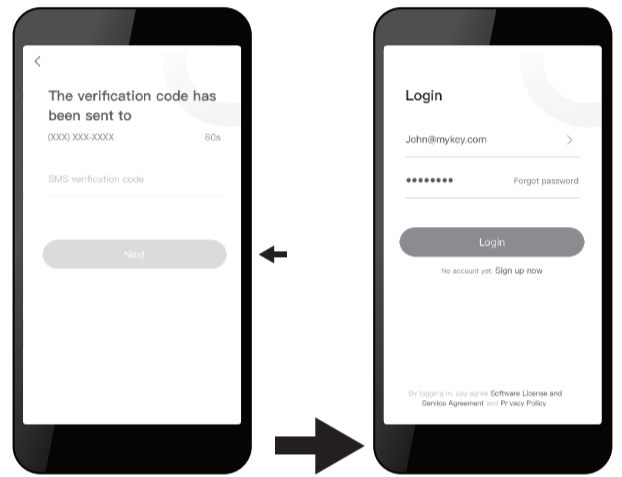

⚠ Write your password down so you don't forget

4 Change Lock Settings

1. Select your lock



Home Screen

2. Press the settings "⚙" in the top right of the lock screen

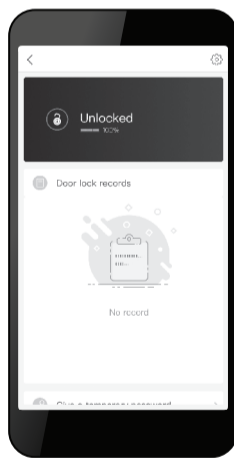

3. Select the setting you want to change

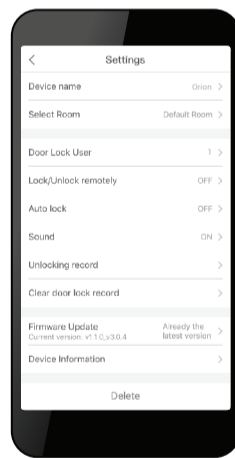

4. Set your preference and hit "Save"

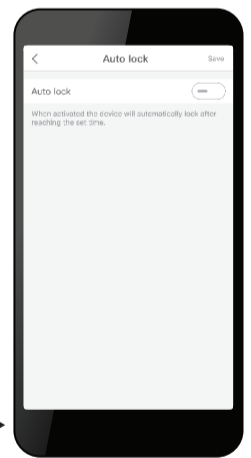

5. Follow the on screen instructions to put the lock into setup mode

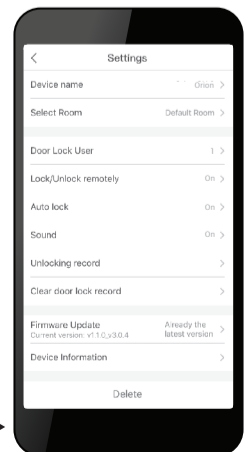
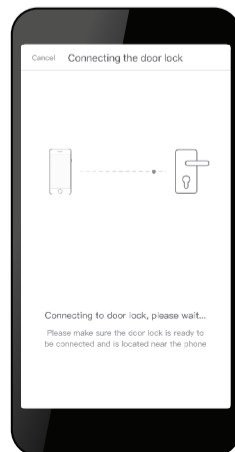
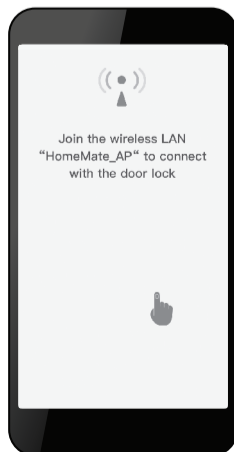

- ← Add users
- ← Autolock Settings
- ← Sound On/Off



**Make sure your phone is on the Homemate _AP network
If unsuccessful please try again starting at step 4**



2 How to Add a Lock - Must Complete Setup to Use App Features

1. Press "Add device" on the home screen



2. Press "Door Lock"

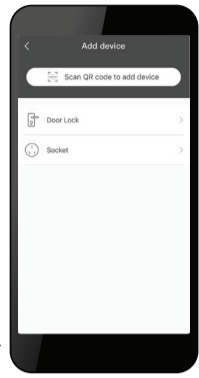

3. Select your Lock from the list

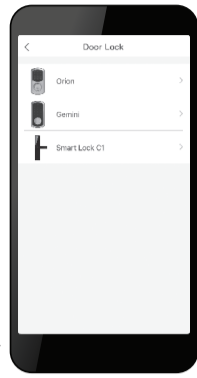

4. Follow the App on screen instructions to put the lock into setup mode

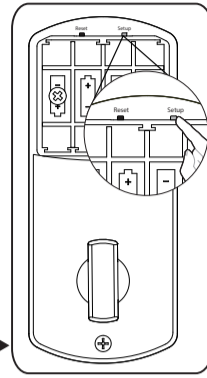
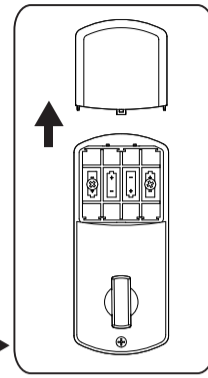
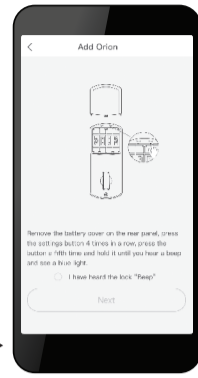

5. Continue to follow the on screen instructions

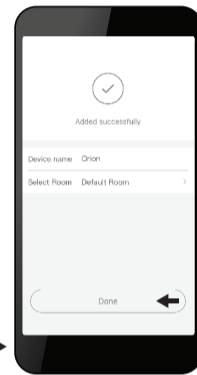
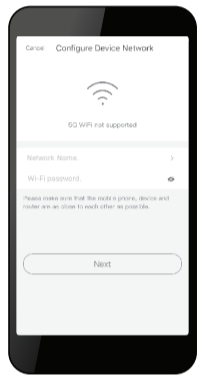
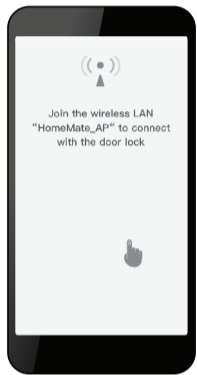

6. Select wifi network and enter your wifi password

7. Choose a Custom name for your lock



Make sure your phone is on the HomeMate _AP network
The lock flashes blue during this pairing period, once successful the lock will beep and the blue light will turn off.
If pairing is unsuccessful please try again starting at step 3

5 Additional Functions

You can use the APP to use these features

Create Temporary Passcodes

1. Select the lock from the home screen
2. Press "Give a temporary password"
3. Press the "+" in the top right corner of the screen
4. Customize the name, number of uses, and the period of time in which the password will remain valid
5. Press "Get a temporary password"
6. Copy temporary password to send via SMS or write it down

The is part of the temporary passcode



Emergency Password

This lock includes a unique "Emergency Password" feature. An emergency password will send an Emergency Alert to all group users.

1. Select the lock from the home screen
2. Press the "⚙️" in the top right corner of the screen
3. Select Door Lock User
4. Select the User that you wish to give a code
5. Press the red "Emergency Password" button
6. Follow the on screen instructions to add an Emergency Password for this user.

Alert will be sent to all users in the group except the selected "associated group members".

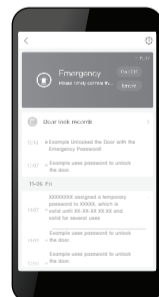

Remote Unlocking

Remote unlocking is a feature that allows you to lock and unlock from anywhere. This feature increases power consumption and should only be used in special situations. Disabling this feature increases battery life.

Enable:

1. Press 000+ on the lock keypad
- This setting can only be changed on the keypad

Disable:

1. Select "Lock/Unlock remotely" on the lock setting screen
 2. Toggle "Lock/Unlock remotely" to "Off" and press save.
- This setting can be changed remotely

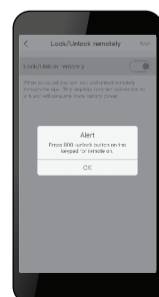

Restore Factory Settings

Remove cover, The reset button is located inside the back panel. Press the reset button on the PCB board 4 times and then press and hold for a 5th until you hear one beep. This indicates that the lock has been reset to the Factory Settings.

Reset Button

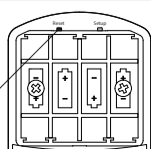

Troubleshooting

Issue	Solution
Lock will not function electronically.	<ul style="list-style-type: none"> • Check that all batteries are new high quality Alkaline Batteries • Check for proper polarity (+ -) of all batteries • Check that the Control Wire is attached to the Interior Assembly • Remove 1 battery for 5 seconds to reset lock. Reinstall battery
Lock gives error signal when opening or locking. Latch will not extend or retract completely when closed.	<ul style="list-style-type: none"> • Unlock door using Key or Interior Knob • While door is open, check that the Latch operates smoothly • Check for proper alignment of the strike plate, adjust as needed to assure there is no binding against the Latch
The Latch is sticking.	<p>Installation screws of the lock may be too tight and have to be loosened</p> <ul style="list-style-type: none"> • Remove Interior Assembly • Slightly loosen the Mounting plate screws • Lock and unlock using the Key • Reattach Control Wire and Interior Assembly
App screen is stuck on "Connecting the Door Lock"	<ul style="list-style-type: none"> • Wait a few minutes as the lock server may be busy • Hit "Cancel" and attempt to connect again, this may complete the process
The App is unable to connect to a lock.	<ul style="list-style-type: none"> • Make sure your phone has wifi is enabled • If "HomeMate_AP" is not automatically chosen then you must manually select it as your wifi network to modify settings • Hit "Cancel" and attempt to connect again, this may complete the process
The Lock is offline.	<ul style="list-style-type: none"> • Press 1 → 0 → , this will reconnect the lock • Remove 1 battery for 5 seconds to reset lock. Reinstall battery
Lock not showing correct locked/ unlocked status in App.	<ul style="list-style-type: none"> • Back out of menus until you are in the home screen, then reselect your lock • Manually lock and unlock the lock • Lock and unlock using the keypad • Wait a few minutes as the lock server may be busy
Forgotten Password.	<ul style="list-style-type: none"> • On the home screen select the Forgot Password option, then select the account type that was registered, and follow the prompts to create a new Password
Latch is not locking in inclement weather.	<ul style="list-style-type: none"> • Push or pull door to direct latch • Readjust latch for smoother operations

Contact Us First! Do Not Return to Store

EMAIL: locks@lewishymaninc.com
WEBSITE: www.truboltlocks.info
ADDRESS: Consumer Assistance Dept.
Lewis Hyman, Inc.
860 East Sandhill Avenue
Carson, CA 90746 USA
TELEPHONE: US/Canada 800-860-1677 Ext. 1801 (Toll Free)

3

Change Admin Passcode

You must first set a new admin password in order to change any lock settings

1. Remove battery cover

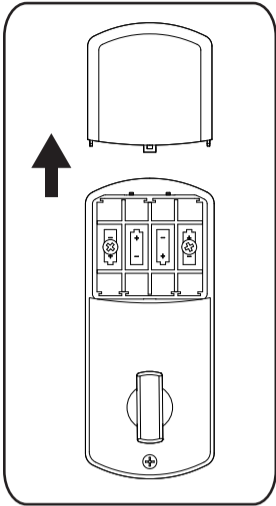

2. Hold the "Setup" button for 2 seconds until the Keypad lights up

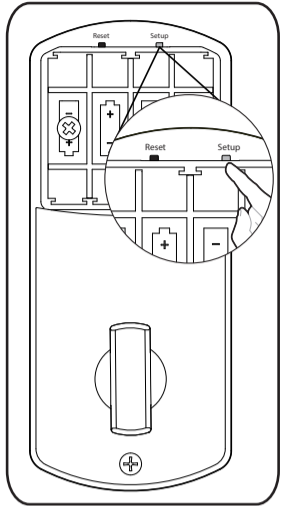

3. Enter a new 6 digit admin code

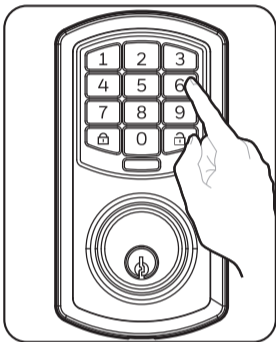

4. Repeat the 6 digit admin code to reconfirm

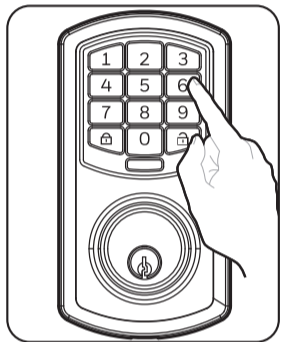

The lock will flash Green and beep letting you know the process was successful

⚠ Write your admin passcode down so you don't forget

Limited 1-Year Electronic Warranty Limited Lifetime Mechanical and Finish Warranty

This Tru-Bolt® product comes with a 1-Year Limited Warranty on Electronic Parts and a Limited Lifetime Mechanical and Finish Warranty against defects in materials and workmanship under normal use to the original residential user. Proof of purchase and ownership is required for the warranty to be in effect. This warranty is non transferable and applies to the original purchaser only, as long as the original purchaser occupies the residential premises upon which the product[s] was originally installed. This warranty DOES NOT COVER removal and reinstallation of product[s], scratches, abrasions, deterioration due to the use of paints, solvents or other chemicals, abuse, misuse, or product[s] used in commercial applications, does not cover any losses, injuries to persons/property or costs, and shipping and freight expenses required to return product[s]. In no event shall Tru-Bolt® be liable for any special, incidental or consequential damages. If this product[s] is considered a consumer product, please be advised that some local and state laws do not allow limitations on incidental or consequential damages or how long an implied warranty lasts, so that the above limitations may not fully apply. Refer to your local laws for your specific rights under this warranty. If there are any problems please call our customer service with any questions or concerns.

Package Warranty:

Limited Lifetime Mechanical & Finish Warranty:

This Tru-Bolt® product[s] comes with a 1-Year Limited Warranty on Electronic Parts and a Limited Lifetime Mechanical and Finish Warranty against defects in materials and workmanship under normal use to the original residential user. If there are any problems please call our customer service with any questions or concerns. See installation instructions for full terms and conditions.

DO NOT RETURN TO STORE

For questions / comments, technical assistance or repair parts – please call toll free at: 1-800-860-1677 x 1801 (M-F 7am-5pm PST)

Don't forget to register your lock at www.Truboltlocks.info for updates.

1743010 1743011 V0 E