

SC21F50 series

Vacuum Cleaner user manual

- * Before operating this unit, please read the instructions carefully.
- * For indoor use only.

English

imagine the possibilities

Thank you for purchasing a Samsung product.
To receive a more complete service,
please register your product at
www.samsung.com/register

SAMSUNG

safety information

SAFETY INFORMATION



- Before operating the appliance, please read this manual thoroughly and retain it for your reference.



- Because these following operating instructions cover various models, the characteristics of your vacuum cleaner may differ slightly from those described in this manual.

CAUTION/WARNING SYMBOLS USED

	Indicates that a danger of death or serious injury exists.
	Indicates that a risk of personal injury or material damage exists.

OTHER SYMBOLS USED

	Represents something you must NOT do.
	Represents something you must follow.
	Indicates that you must disconnect the power plug from the socket.



This vacuum cleaner is designed for household use only.

Do not use this vacuum cleaner to clean building waste and debris.

Regularly keep the filters in clean conditions to prevent of collecting fine dust in them.

Do not use this vacuum cleaner with any of the filters removed.

Failure to meet these requirements could cause damage to the internal parts and void your warranty.

IMPORTANT SAFEGUARDS

GENERAL

- Read all instructions carefully. Before switching on, make sure that the voltage of your electricity supply is the same as that indicated on the rating plate on the bottom of the cleaner.
- **WARNING** : Do not use the vacuum cleaner when rug or floor is wet. Do not use to suck up water.
- Close supervision is necessary when any appliance is used by or near children. Do not allow the vacuum cleaner to be used as a toy. Do not allow the vacuum cleaner to run unattended at any time. Use the vacuum cleaner only for its intended use as described in these instructions.
- Do not use the vacuum cleaner without a dust bin. Empty the dust bin before it is full in order to maintain the best efficiency.
- Do not use the vacuum cleaner to pick up matches, live ashes or cigarette butts. Keep the vacuum cleaner away from stoves and other heat sources. Heat can deform and discolour the plastic parts of the unit.
- Avoid picking up hard, sharp objects with the vacuum cleaner as they may damage the cleaner parts.
Do not stand on the hose assembly. Do not put weight on the hose.
Do not block the suction or the exhaust port.
- Switch the vacuum cleaner off on the body of the machine before unplugging from the electrical outlet. Disconnect the plug from the electrical outlet before emptying the dust bin. To avoid damage, please remove the plug by grasping the plug itself, not by pulling on the cord.
- This appliance can be used by children aged from 8 years and above and persons with reduced physical, sensory or mental

safety information

capabilities or lack of experience and knowledge if they have been given supervision or instruction concerning use of the appliance in a safe way and understand the hazards involved. Children shall not play with the appliance. Cleaning and user maintenance shall not be made by children without supervision.

- Children should be supervised to ensure that they do not play with the appliance.
- The plug must be removed from the socket outlet before cleaning or maintaining the appliance.
- The use of an extension cord is not recommended.
- If your vacuum cleaner is not operating correctly, switch off the power supply and consult an authorized service agent.
- If the supply cord is damaged, it must be replaced by the manufacturer or its service agent or a similarly qualified person in order to avoid a hazard.
- Don't carry the vacuum cleaner by holding the hose. Use the handle on the vacuum cleaner set.
- Unplug the cleaner when not in use. Turn off the power switch before unplugging.

UV BRUSH

- Since the UV rays from the UV Brush damage skin and eyes, never allow the rays to make contact with skin or eyes and do not let children or the elderly use the UV Brush. It may damage your eyesight.
- If the transparent window is broken and the UV rays are exposed directly, turn the power off and contact the service center.
- Do not use the UV Brush for purposes other than the sterilization of mattresses, bedclothes, beds, cushions and so on made from material. The company will not be held liable for any loss due to accidents from using the UV Brush for purposes other than its original purpose as listed above.

- Do not sit on the UV Brush or drop it, and avoid imparting impacts on the product. Failing to do so may result in injury or product damage.
- Do not touch the power terminals on the back of the UV Brush with a metal pin or rod. This may result in electric shock or fire.
- When the UV lamp is out of order, never disassemble or modify the product yourself.
Please contact the manufacturer or service center for a replacement.
- Since an internal discharge occurs within the UV Brush, never use the product near an inflammable spray or substance.
- Take care not to touch the UV lamp window after using the UV Brush for an extended period of time as the surface of the window may be hot.
- The UV Brush may start slowly at a low temperature due to the inherent characteristics of UV lamps. Please keep the UV Brush indoors.

contents

ASSEMBLING THE CLEANER

07

OPERATING THE CLEANER

08

- 08 Power cord
- 08 Power control
- 10 Using the UV brush (SC21F50U Series)

MAINTAIN TOOLS AND FILTER

11

- 11 Using accessory
- 13 Maintain floor tools
- 16 Emptying the dust bin
- 17 Cleaning the dust filter
- 18 Cleaning the dust filter
- 19 Cleaning the outlet filter

TROUBLESHOOTING

20

assembling the cleaner

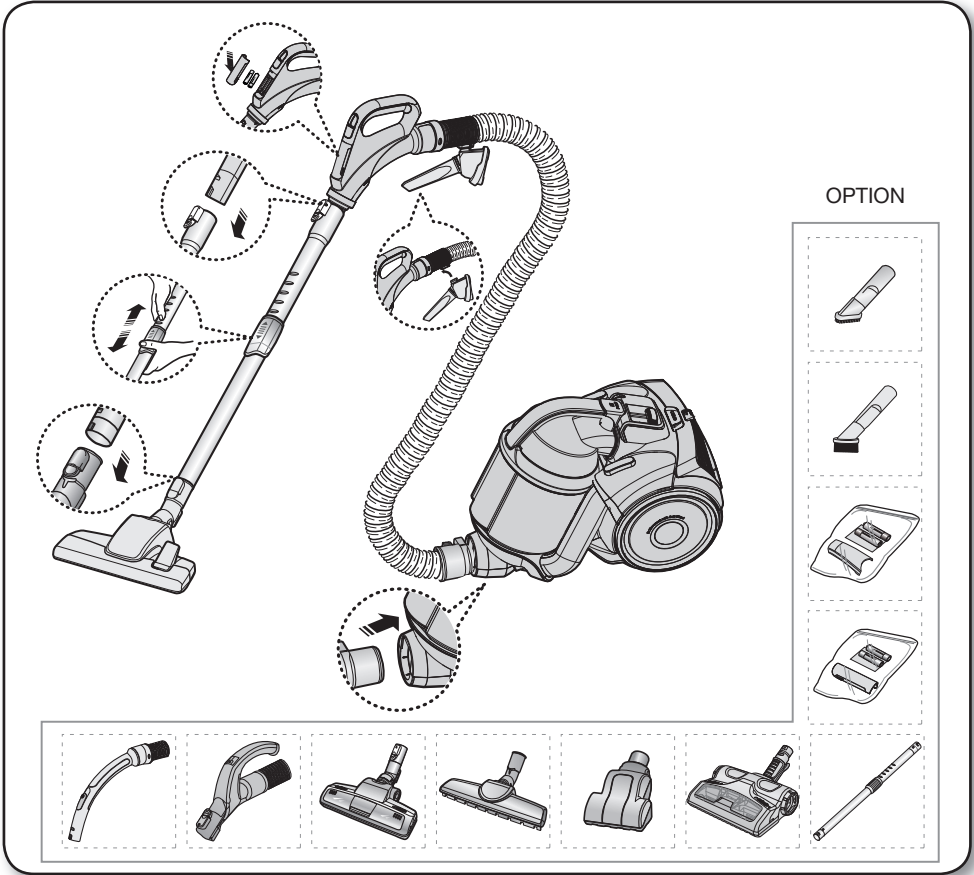

- ★ Please do not press the button of dust bin handle when carrying machine.



- ★ For storage, park the floor nozzle.

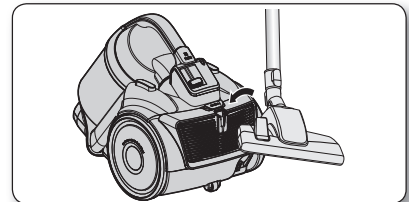

operating the cleaner

POWER CORD

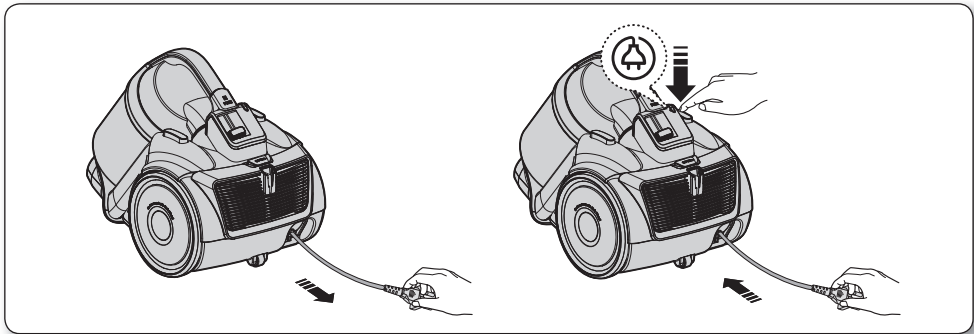

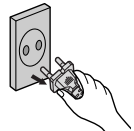

- When removing the plug from the electrical outlet, grasp the plug, not the cord.



POWER CONTROL

Radio frequency remote-control (SC21F50H, SC21F50U Series)

HOSE (SC21F50H Series)

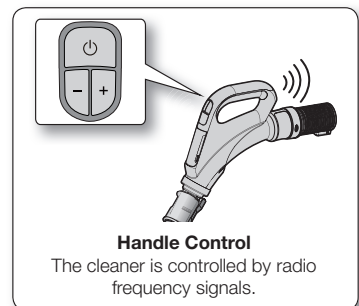

1. ON/OFF [] Button
 - Press the [] button to operate the vacuum cleaner. Press again to stop the vacuum cleaner.
2. Suction [+], [-] Button
 - Press the [+] button to operate the vacuum to high suction power. Press the [-] button to operate the vacuum to low suction power.





If no button is pressed for 30 minutes while cleaning, the safety device is activated and the power is cut off.

In this case, press the [Power] button on the main unit or unplug and then plug the power cord in again.

HOSE (SC21F50U Series)

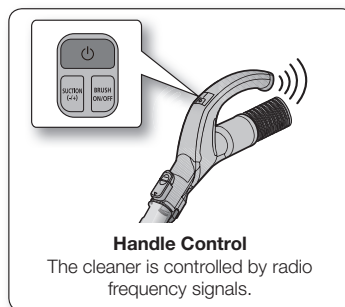
- ON/OFF [] Button
 - Press the [] button to operate the vacuum cleaner. Press again to stop the vacuum cleaner.
- [SUCTION (-/+)] Button
 - Press the [SUCTION (-/+)] button to increase or decrease the suction power. Each time you press the button, you gradually increase the suction power. After the suction power reaches its maximum, the next time you press the button, you return the suction power to its minimum.
- [BRUSH ON/OFF] Button
 - Press the [BRUSH ON/OFF] button to operate the UV Brush. Press again to stop the UV Brush.



-  If no button is pressed for 30 minutes while cleaning, the safety device is activated and the power is cut off.
In this case, press the [Power] button on the main unit or unplug and then plug the power cord in again.

Change the battery

- 
 - When the vacuum cleaner does not work, replace the batteries. If the problem persists, please contact our authorized dealer.
 - Use 2 batteries of size AAA.



- Never disassemble or recharge the batteries.
- Never heat up the batteries or throw them into fire.
- Do not reverse (+), (-) poles.
- Dispose of the batteries properly.

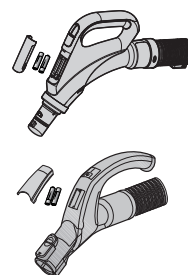

BATTERY TYPE : AAA Size



BODY

Press the power ON/OFF button repeatedly to start and to stop the vacuum cleaner. (OFF → ON → OFF)

-  If the remote handle control is not working, the cleaner can be operated using the ON/OFF button on the body of the machine.

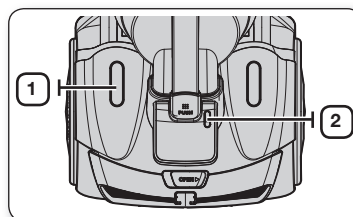

1



The ON/OFF button operates the vacuum cleaner or stops it.

2



The filter light is illuminated when the dust pack requires checking or emptying.

Body-control type (SC21F50V Series)

- HOSE

To reduce suction for leaning draperies, small rugs, and other light fabrics, pull the tap air until the hole is open

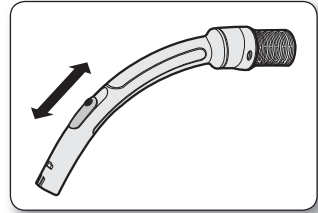

- BODY

To control power level, just slide the power control up and down.

MIN = For delicate fabrics, e.g.net curtains.

MAX = For hard floors and heavily soiled carpets.

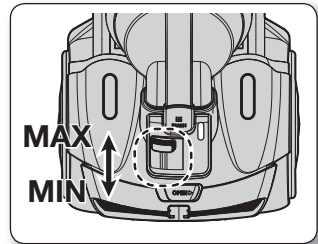

USING THE UV BRUSH (SC21F50U SERIES)

1. Insert the brush into the hose handle.
 - Insert the UV brush securely into the hose handle until you hear a “clicking” sound.

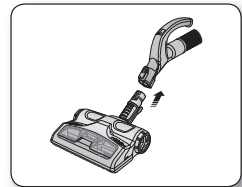

2. Press the [BRUSH ON/OFF] button to start cleaning.
 - Press the [BRUSH ON/OFF] button and choose the appropriate suction strength for the cleaner.
 - It is advisable to select the (Max) suction strength setting.
 - UV sterilization cannot be activated by itself.

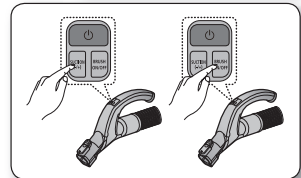

3. When you have finished UV cleaning, press the [] button.
 - Press the [] button to stop the cleaner.
- For safety reasons, UV brushing only runs for 30 minutes and then stops operating. To resume the operation, press the [SUCTION (-/+)] button again.

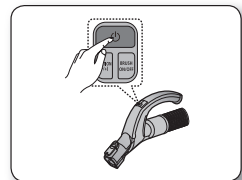

The UV brush, which is inserted into the hose handle (not directly connected to the telescopic pipe), is dedicated for bedclothes.

maintain tools and filter

USING ACCESSORY

Pipe

- Adjust the length of the telescopic pipe by sliding the length control button located in the center of the telescopic pipe back and forth.

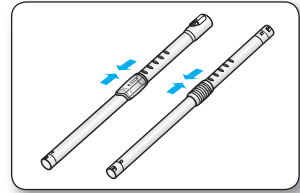

- To check for blockages, separate the telescopic pipe and adjust to shorten. This allows for easier removal of waste clogging the tube.

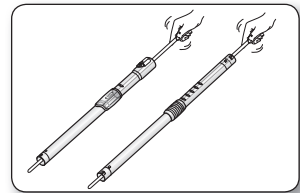

Accessory (SC21F50H, SC21F50V Series)

- To use the upholstery tool, push the accessory on to the end of the hose handle.

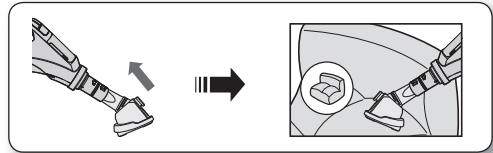

- Pull out the button, to use the dusting brush.

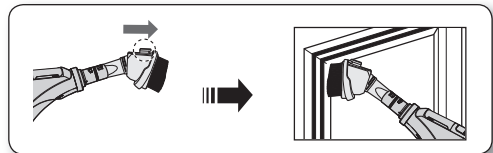

- To use the crevice tool, push the accessory on to the end of the hose handle in the opposite direction.

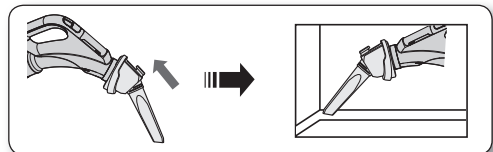

maintain tools and filter

Accessories (SC21F50U Series)

- Push the accessory onto the end of the hose handle.

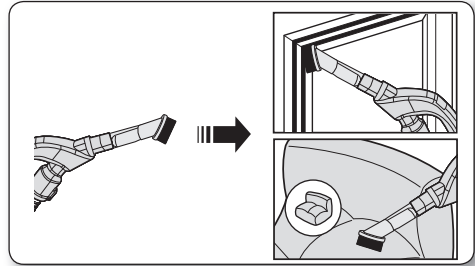

- Pull out the dusting brush to use the crevice tool.

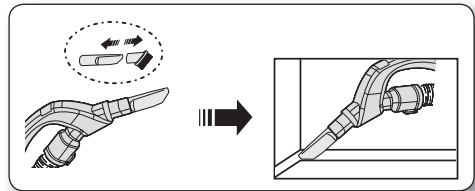

- Push the accessory onto the end of the pipe.

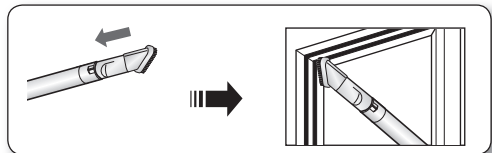

- Pull out the dusting brush to use the crevice tool.

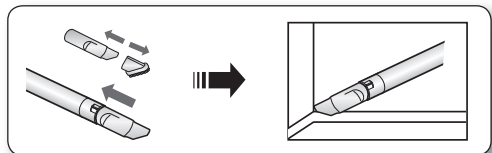

MAINTAIN FLOOR TOOLS

2-Step Brush

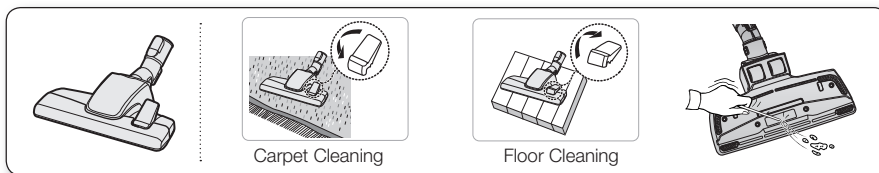

- Adjust the inlet lever according to the floor surface.
- Remove waste matter completely if the inlet is blocked.

Power Pet Plus Brush (Option)

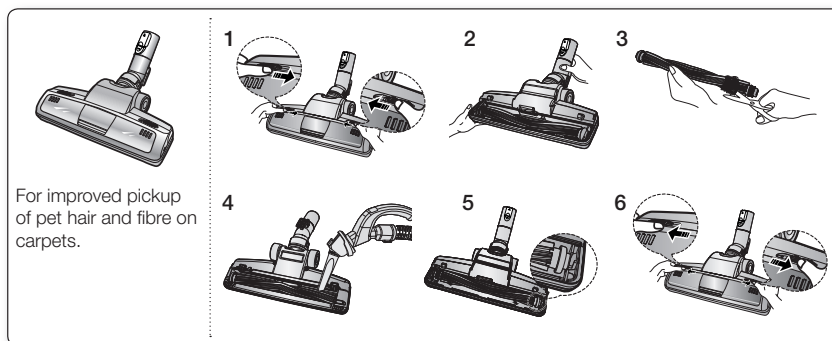

Frequent vacuuming of hair or pet fur may cause a falling-off of the rotation due to matters tangled around the drum. In this case, clean the drum with care.

1. Push the Open button of the transparent screen cover to separate the cover.
2. Remove the brushbar from the transparent screen.
3. Remove waste matter such as dust and hair tangled around the brushbar using scissors.
4. Remove dust inside the brush housing using a dry duster or crevice tool.
5. Insert brushbar into rotating belt and assemble.
6. Click the transparent screen cover back into place to reassemble.

Parquet Master Brush (Option)

- Vacuum dust in wide area at once.
- Remove waste matter completely if the inlet is blocked.

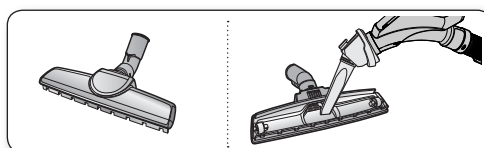

maintain tools and filter

Mini turbo brush (Option)

- To replace brushroll

1. If a clog is present or debris is visible, unscrew the two screws on the back of the Mini turbo brush to remove the faceplate and clear any obstructions.

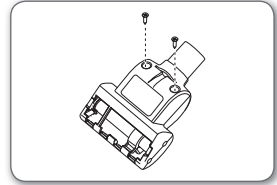

2. Inspect condition of brushroll.
Replace brushroll if brushes are worn down.
To remove brushroll, pull up and out of end slots in nozzle housing.
Insert ends of brushroll into same slots to replace.

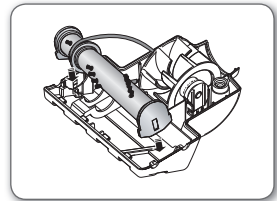

- Inspect belt to ensure that it is in good condition.
If belt is broken or cracked, replace belt according to To Replace Belt instructions.

3. Using at MAX.
Press the MAX button to operate the vacuum at maximum intake.

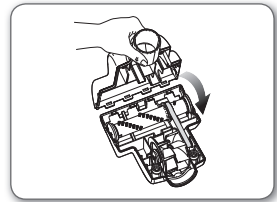

- To replace belt

1. Remove bottom plate.
See figure in To Replace Brushroll instructions.
2. Loop one end of new belt around shaft of pulley.
3. Loop other end of belt around designated area for it on brushroll.
Insert brushroll into slots in nozzle housing.
See figure in To Replace Brushroll instructions.
4. Fit Mini turbo brush back together as described in To Replace Brushroll instructions.

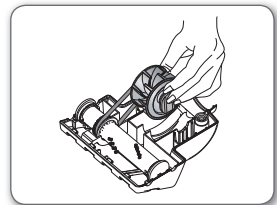
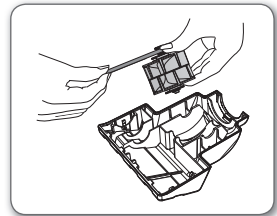

To remove dust from the dust bin of the UV brush (SC21F50U Series)

When you notice that the dust bin is filled, use the [Dust Removal] button to empty the dust bin.

- To remove dust from the dust bin, move the [Dust Removal] button to the "Open" position.
 - While the cleaner is operating (suction), use the [Dust Removal] button for this purpose.
- When done, move the [Dust Removal] button to the "Close" position.
 - When the [Dust Removal] button is in the "Open" position, the suction power of the cleaner is reduced.

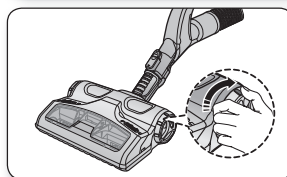
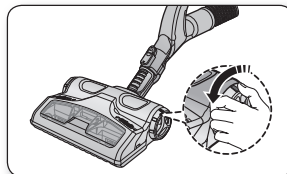

Cleaning the UV brush (Cleaning the drum) (SC21F50U Series)



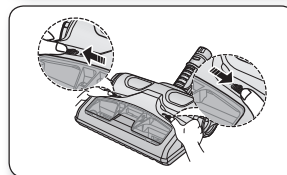
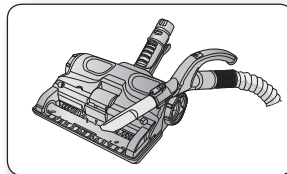
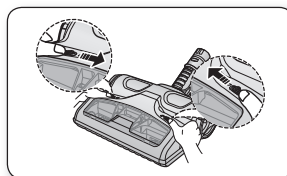

Human and pet hair often becomes tangled in the drum, causing a reduction in the rotary power of the drum. To prevent this, clean the drum on a regular basis.

- Push the [Open Transparent Cover] button inward to remove the cover.
- Use the crevice tool to remove impurities such as dust and hair from around the drum.
- When done, push the [Open Transparent Cover] button outward to close the cover.



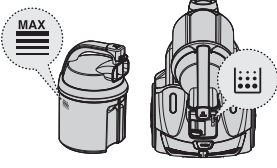
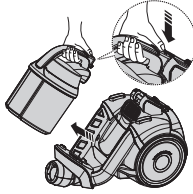

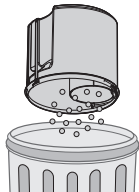

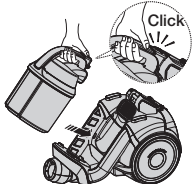

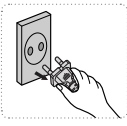

maintain tools and filter

EMPTYING THE DUST BIN

<p>1</p> 	<p>2</p> 	<p>3</p> 
<p>Once dust reaches the dust full mark, empty the dust bin.</p>	<p>Take the dust bin out by pushing the button.</p>	<p>Separate the dust bin cover.</p>
<p>4</p> 	<p>5</p> 	<p>6</p> 
<p>Throw the dust away in the bin.</p>	<p>Close the dust bin cover.</p>	<p>Before use, push the dust bin into the main body of the vacuum cleaner until you hear the "click" sound.</p>

- Empty into a plastic bag. (recommended for asthma/allergy sufferers)







 You may rinse the dust bin with cold water.

CLEANING THE DUST FILTER

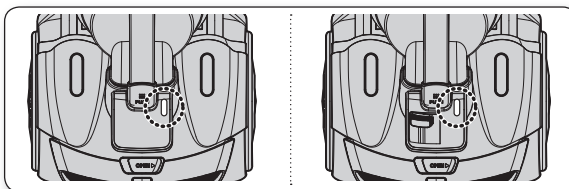
When to clean the dust filter

- The lamp will turn red when suction is reduced. If the light comes on, please clean the dust filter.



- Turn the vacuum power to 'MAX'.

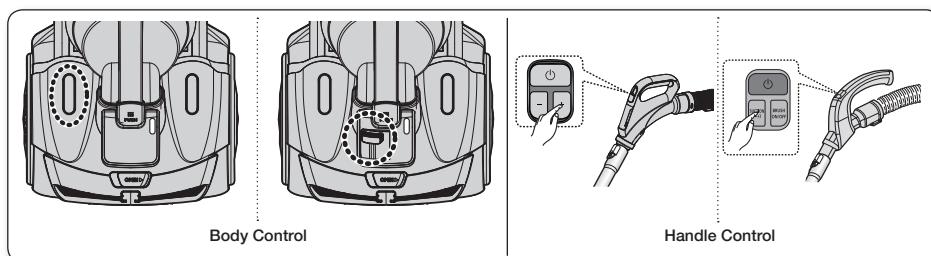

- If the filter check indicator turns red with the inlet floating 10cm above flat floor, clean the dust pack.

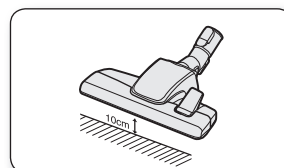

When suction is noticeably reduced continuously or vacuum cleaner abnormally overheats, please clean the dust pack.

maintain tools and filter

CLEANING THE DUST FILTER

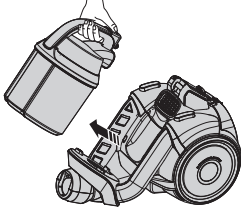
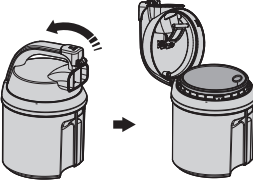
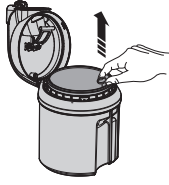
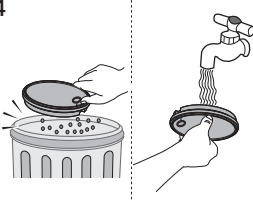
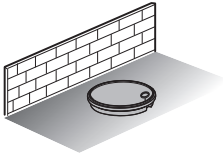
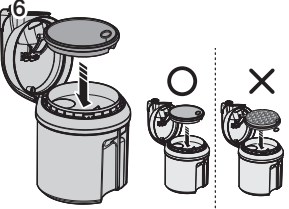
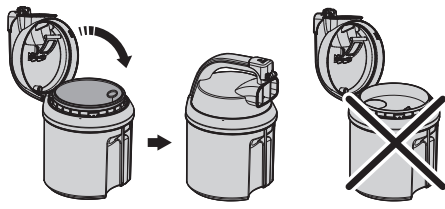
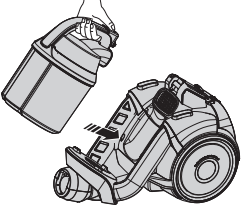

<p>1</p>  <p>Take the dust bin out.</p>	<p>2</p>  <p>Pull the dust bin cover to open.</p>	<p>3</p>  <p>Remove the filter from the dust bin.</p>
<p>4</p>  <p>Shake the filter over a garbage can to remove loose dust, then wash the filter with water.</p>	<p>5</p>  <p>Let the filter dry in the shade for more than 12 hours.</p>	<p>6</p>  <p>Put the filter into the dust bin.</p>
<p>7</p>  <p>Close the dust bin cover.</p> <p>To close the dust bin cover, filter should be assembled.</p>	<p>8</p>  <p>Before use, push the dust bin into the main body of the vacuum cleaner until you hear the "click" sound.</p>	



Make sure the filter is completely dry before putting it back into the vacuum cleaner. Allow 12 hours for it to dry.

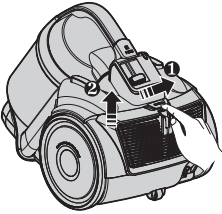
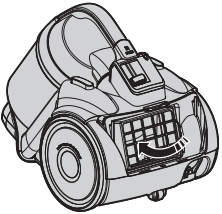

CLEANING THE OUTLET FILTER

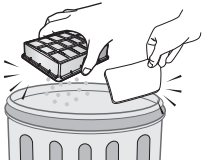
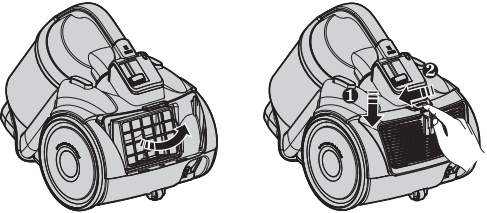
<p>1</p>  <p>Remove the fixed frame part at the back of the main body.</p>	<p>2</p>  <p>Pull out the HEPA filter using the tab.</p>	<p>3</p>  <p>Pull out the micro filter</p>
<p>4</p>  <p>Clean the filter.</p>	<p>5</p>  <p>Put the HEPA filter and frame part into the main body.</p>	



- When suction is noticeably reduced continuously or vacuum cleaner abnormally overheats, please clean the outlet filter. Note. Do not wash HEPA filter. If cleaning does not resolve the problem Please replace blocked out filter.
- Replacement filters are available at your local Samsung distributor.

troubleshooting

PROBLEM	SOLUTION
Motor does not start.	<ul style="list-style-type: none">• Check cable, plug and socket.• Leave to cool.
Suction force is gradually decreasing.	<ul style="list-style-type: none">• Check for blockage and remove.
Cord does not rewind fully.	<ul style="list-style-type: none">• Pull the cord out 2-3 m and push down the cord rewind button.
Vacuum cleaner does not pick up dirt.	<ul style="list-style-type: none">• Check hose and replace if required.
Low or decreasing suction.	<ul style="list-style-type: none">• Please check filter and, if required, clean as illustrated in the instructions. If filters are out of condition change them to new ones.
Body overheating.	<ul style="list-style-type: none">• Please check filters, if required clean as illustrated in the instruction.
Static electricity discharge.	<ul style="list-style-type: none">• Please decrease power suction.• This can also occur when air in the room is very dry. Please ventilate the room to air humidity become a normal.

memo

memo

memo



Code No. DJ68-00699R REV(0.0)