

Operating and installation instructions Induction hobs



It is **essential** to read the operating and installation instructions before setup, installation, and commissioning. This prevents both personal injury and damage to the appliance.

Contents

Warnings and safety notes	5	Special functions.....	35
Sustainability and environmental protection	12	Controlling a cooker hood	35
Installation	13	Permanent pan recognition.....	36
Safety notes for installation	13	Pan size recognition	36
Additional safety notes for surface-mounted installation	13	PowerFlex XL cooking area	36
Additional safety notes for flush-fit installation	14	Hob Booster	36
Safety distances	15	Stop&Go.....	36
Installation dimensions for surface-mounted installation	22	Hob power levels.....	36
KM 8484 FR	22	Auto heat-up	36
KM 8484 FL.....	23	Timer functions	36
Installation dimensions for flush-fit installation	24	System lock.....	37
KM 8484 FL.....	24	Keypad lock	37
KM 8486 FX.....	25	Recall.....	37
Installing a surface-mounted hob ...	26	Keeping warm	37
Preparing the worktop for surface-mounted installation	26	Wipe protection.....	37
Installing a surface-mounted hob	26	Settings.....	37
Installing the hob flush with the worktop	26	Demo mode.....	37
Preparing the worktop for flush-fit installation	26	Residual heat indicator	37
Installing a flush-fit hob	26	Safety switch-off	37
Electrical connection	27	Overheating protection.....	38
Familiarisation	30	Model identifier and serial number.....	38
Your hob	30	Software version.....	38
KM 8484 FR, KM 8484 FL, KM 8486 FX.....	30	Software update	38
Controls and indicators	31	Optional accessories	39
Cooking zone data.....	33	Commissioning	40
Power management.....	34	Unpacking the hob	40
Operation.....	34	Cleaning the hob for the first time...	40
Networking.....	35	Switching on the hob for the first time	40
		Networking.....	40
		Requirements for networking with your home network.....	40
		Using NFC	40
		Performing Scan & Connect.....	41
		Requirements for direct networking with your Miele cooker hood.....	41
		Networking your hob with your Miele cooker hood.....	41
		Resetting settings	41

Operation	43	Timer functions.....	47
Safety notes for operation.....	43	Setting the time.....	47
Switching the hob on	43	Setting the timer.....	47
Switching the hob/a cooking zone off.....	43	Changing the timer.....	47
Positioning cookware on		Deleting the timer.....	47
PowerFlex XL cooking areas	44	Setting the duration of a cook- ing process	47
Hob power levels.....	44	Changing the duration of a cooking process.....	48
Setting the power level for a cooking zone.....	44	Deleting the duration of a cook- ing process	48
Setting the power level for a cooking zone – without inter- mediate levels	44	Setting a duration for further cooking processes.....	48
Changing the power level for a cooking zone.....	45	Starting elapsed time measure- ment of a cooking process	48
PowerFlex XL cooking area	45	Cancelling elapsed time meas- urement of a cooking process	48
Booster	45	Starting elapsed time measure- ment of further cooking pro- cesses	49
Activating the Booster	45	Switching between the power level display and timer function display	49
Deactivating the Booster.....	45	System lock.....	49
Activating/deactivating Stop&Go ..	45	Activating the system lock	49
Auto heat-up	46	Deactivating the system lock.....	49
Activating auto heat-up.....	46	Keypad lock.....	49
Deactivating auto heat-up.....	47	Activating the keypad lock	49
		Deactivating the keypad lock.....	50
		Recall	50
		Activating the Recall function....	50
		Discarding the Recall function....	50
		Wipe protection	50
		Activating wipe protection	50
		Deactivating wipe protection.....	50
		Hob data.....	50
		Displaying the model identifier/ serial number	50
		Displaying the software version .	51
		Activating/deactivating demo mode.....	51
		Setting ranges for the hob power levels.....	52
		Notes for test institutes	53

Contents

Good to know	54
How induction hobs work	54
Noises	54
Cookware.....	54
Adjusting settings	56
Displaying the model identifier/ serial number	60
Displaying the software version	60
Software update	60
Cleaning and care	62
Safety notes on cleaning and care ..	62
When to clean.....	62
Cleaning the ceramic glass sur- faces	62
Unsuitable cleaning agents.....	63
Troubleshooting	64
Messages in the display	64
Unexpected behaviour.....	65
Unsatisfactory results.....	66
General problems or technical faults.....	67
Customer Service	68
Contact in the event of a fault	68
Data plate	68
Warranty	68
Technical data	69
Technical data	69
Product data sheets.....	69
EU Conformity declaration.....	70
UK Conformity declaration	70



This hob complies with all relevant local and national safety requirements. Inappropriate use can, however, lead to personal injury and material damage.

Read the operating and installation instructions carefully before using the hob. They contain important information on safety, installation, use and maintenance. This prevents both personal injury and damage to the hob.

In accordance with standard IEC 60335-1, Miele expressly and strongly advises that you read and follow the instructions in the chapter on installing the hob as well as the warnings and safety notes.

Miele cannot be held liable for injury or damage caused by non-compliance with these instructions.

Keep the operating and installation instructions in a safe place and pass them on to any future owner.

Correct application

- ▶ This hob is intended for domestic use and use in other similar environments.
- ▶ This hob is not intended for outdoor use.
- ▶ It is intended for domestic use only to cook food and keep it warm. Any other use is not supported by the manufacturer and could be dangerous.
- ▶ This hob is not intended for use by people with reduced physical, sensory or mental capabilities or lack of experience and knowledge, unless they have been given supervision and instruction concerning its use by a person responsible for their safety. They may only use the hob unsupervised if they have been shown how to use it in a safe way. They must be able to recognise and understand the dangers of misuse.

Safety with children

- ▶ Children under 8 years of age must be kept away from the hob unless they are constantly supervised.

Warnings and safety notes

- ▶ Children over 8 years of age may use the hob without supervision if its operation has been clearly explained to them and they are able to use it safely. Children must be able to understand and recognise the possible dangers caused by incorrect operation.
- ▶ Children must not be allowed to clean the hob unsupervised.
- ▶ Children should be supervised in the vicinity of the hob. Never allow children to play with the hob.
- ▶ The hob gets hot when in use and remains hot for a while after being switched off. Keep children well away from the hob until it has cooled down and there is no danger of burning.
- ▶ Danger of burning. Do not store anything which might arouse a child's interest in storage areas above or behind the hob. Otherwise they could be tempted to climb onto the hob.
- ▶ Risk of burning and scalding. Place pots and pans on the cooking zone in such a way that children cannot pull them down and burn themselves.
- ▶ Danger of suffocation! Whilst playing, children may become entangled in packaging material (such as plastic wrapping) or pull it over their head with the risk of suffocation. Keep packaging material away from children.
- ▶ Activate the system lock to ensure that children cannot switch on the hob inadvertently. Use the keypad lock when the hob is in use to prevent children from altering the settings selected.

Technical safety

- ▶ Unauthorised installation, maintenance and repairs can pose a considerable risk to the user. Installation, maintenance and repairs must only be carried out by a Miele authorised technician.
- ▶ Damage to the hob can compromise your safety. Check the hob for visible signs of damage. Do not use the hob if it is damaged.

Warnings and safety notes

▶ Temporary or permanent operation on an autonomous power supply system or a power supply system that is not synchronised with the mains power supply (e.g. island networks, back-up systems) is possible. A prerequisite for operation is that the power supply system complies with the specifications of EN 50160 or an equivalent standard.

The function and operation of the protective measures provided in the domestic electrical installation and in this Miele product must also be maintained in isolated operation or in operation that is not synchronised with the mains power supply, or these measures must be replaced by equivalent measures in the installation. As described, for example, in the current version of BS OHSAS 18001–2 ISO 45001.

▶ The electrical safety of this hob can only be guaranteed when correctly earthed. It is essential that this basic safety requirement is fulfilled. If in doubt, the electrical installation should be checked by a qualified electrician.

▶ The connection data (voltage and frequency) on the data plate of the hob must match the mains power supply in order to avoid the risk of damage to the hob.

Compare this data before connecting the appliance. If in any doubt, consult a qualified electrician.

▶ Do not connect the hob to the mains electrical supply by a multi-socket adapter or extension lead. These are a fire hazard and do not guarantee the required safety of the appliance.

▶ For safety reasons, this hob may only be used after it has been built in.

▶ This hob must not be used in a non-stationary location (e.g. on a ship).

▶ Any contact with live connections or tampering with the electrical or mechanical components of the hob will endanger your safety and may lead to the hob malfunctioning.

Do not open the hob housing under any circumstances.

▶ While the hob is under warranty, repairs should only be undertaken by a Miele authorised service technician. Otherwise the warranty is invalidated.

▶ Miele can only guarantee the safety of the appliance when genuine original Miele replacement parts are used. Faulty components must only be replaced by Miele spare parts.

Warnings and safety notes

- ▶ The hob is not intended for use with an external timer switch or a remote control system.
- ▶ The hob must be connected to the mains power supply by a qualified electrician.
- ▶ If the mains connection cable is damaged, it must be replaced with a special mains connection cable by a qualified electrician.
- ▶ During installation, maintenance and repair work, the hob must be completely disconnected from the electricity supply. It is only completely isolated from the electricity supply when:
 - The mains fuse has been disconnected or
 - The screw-out fuses have been fully unscrewed or
 - The mains plug (if present) is removed from the socket. To do this, pull the mains plug and not the mains connection cable.
- ▶ Risk of electric shock. Do not use the hob if it is faulty, or if the ceramic surface is cracked, chipped or damaged in any way. Switch it off immediately. Disconnect the hob from the mains electricity supply. Contact the Customer Service Department.
- ▶ If the hob is installed behind a furniture front, do not close the door while the hob is in use. Heat and moisture can build up behind the furniture front when closed. This can result in damage to the hob, the housing unit and the floor. Do not close the furniture front until the residual heat indicators go out.
- ▶ In areas which may be subject to infestation by cockroaches or other vermin, pay particular attention to keeping the appliance and its surroundings clean at all times. Any damage caused by cockroaches or other vermin will not be covered by the warranty.

Correct use

- ▶ The hob gets hot when in use and remains hot for quite a while after being switched off. There is a risk of burning until the residual heat indicators go out.
- ▶ Oil and fat can overheat and catch fire. Do not leave the hob unattended when cooking with oil and fat. If it does ignite do not attempt to put the flames out with water. Disconnect the hob from the mains and use a suitable fire blanket, saucepan lid, damp towel or similar to smother the flames.
- ▶ Do not leave the hob unattended whilst it is being used. It should be continually monitored whilst boiling and flash frying.

Warnings and safety notes

- ▶ Flames could set the grease filters of a cooker hood on fire. Do not flambé under a cooker hood.
- ▶ Spray canisters, aerosols and other inflammable substances can ignite when heated. Therefore do not store such items or substances in a drawer under the hob. Cutlery inserts must be heat-resistant.
- ▶ Do not heat an empty pan.
- ▶ Do not heat up food in closed containers e.g. tins or sealed jars on the hob, as pressure can build up in the container, causing it to explode.
- ▶ Do not cover the hob, e.g. with a hob cover, a cloth or protective foil. The material could catch fire, shatter or melt if the hob is switched on by mistake or if residual heat is still present.
- ▶ When the hob is switched on either deliberately or by mistake, or when there is residual heat present, there is the risk of metal items placed on the hob heating up. Other materials can melt or catch fire. Damp pan lids might adhere to the ceramic surface and be difficult to dislodge. Do not use the hob as a resting place for anything. Always switch the cooking zones off after use.
- ▶ Switch the hob off after use. Do not wait until the hob switches off automatically because there is no longer any cookware on it. This can cause food to catch fire.
- ▶ You could burn yourself on the hot hob. Protect your hands with heat-resistant pot holders or gloves when working on the hot hob. Do not let them get wet or damp. Heat transfers through damp and wet material more quickly with the risk of scalding or burning yourself.
- ▶ When using an electrical appliance (e.g. a hand mixer) near the hob, ensure that the cable of the electrical appliance cannot come into contact with the hot hob. The cable's insulation could become damaged.
- ▶ Grains of salt, sugar, or sand (e.g. from cleaning vegetables) can cause scratches if they get under the cookware. Make sure the ceramic glass surface and the underside of the cookware are clean before placing down the cookware.
- ▶ Even a light object can cause damage in certain circumstances. Do not drop anything on the ceramic surface.
- ▶ Hot items placed down on the sensor controls and displays can damage the electronic modules underneath. Never place hot pots or pans on the sensor controls and displays.

Warnings and safety notes

- ▶ Do not allow solid or liquid sugar, or pieces of plastic or aluminium foil to get onto the hob when it is hot, as they can damage the ceramic surface when it cools down. If this should occur, turn off the hob immediately and scrape off all the sugar, plastic or aluminium residues while still hot, using a shielded scraper blade. Wear oven gloves when doing this. Allow the ceramic surface to cool down and then clean it with a suitable ceramic glass cleaner.
- ▶ Do not heat empty pans on the hob as this can damage the ceramic glass and/or the cookware. Never leave the hob unattended during use!
- ▶ Rough bases can scratch the ceramic glass. Use only pots and pans with smooth bases.
- ▶ Always lift cookware to move it. This will help prevent scratching.
- ▶ Because induction heating works so quickly, the base of the cookware could, under certain circumstances, heat up to the temperature at which oil or fat self-ignites within a very short time. Never leave the hob unattended during use!
- ▶ Heat oil or fat for a maximum of one minute. Never use the Booster function to heat oil or fat.
- ▶ For people fitted with a heart pacemaker: please note that the area immediately surrounding the hob is electromagnetically charged when it is switched on. It is very unlikely to affect a pacemaker. However, if in any doubt, consult the manufacturer of the pacemaker or your doctor.
- ▶ When switched on, the electromagnetic field of the hob can impair the function of magnetisable objects. Do not leave credit cards, digital storage devices, pocket calculators, etc. in the immediate vicinity of the hob.
- ▶ Metal utensils stored in a drawer under the hob can become hot if the appliance is used intensively for a long time.
- ▶ The hob is fitted with a cooling fan. If a drawer is fitted directly underneath the hob, ensure that there is sufficient space between the drawer and its contents and the underside of the hob in order to ensure sufficient ventilation for the hob.
- ▶ If a drawer is fitted directly underneath the hob, do not store any pointed or small items, paper, serviettes, etc. in the drawer. They could get in through the ventilation slots or be sucked into the casing by the fan and damage the fan or impair cooling.

- ▶ Never use two items of cookware on a cooking zone or PowerFlex XL cooking area at the same time.
- ▶ If the cookware only partially covers a cooking zone or extended zone, the handle could become very hot. Always place cookware in the middle of a cooking or extended zone!
- ▶ The induction generators could be damaged or even destroyed if you use an induction adapter plate for cookware. Do not use induction adapter plates.

Cleaning and care

- ▶ The steam from a steam cleaner could reach live electrical components and cause a short circuit. Do not use a steam cleaner to clean the hob.
- ▶ If the hob is installed above a pyrolytic oven or cooker, do not use the hob during a pyrolytic cleaning programme as this could trigger the overheating protection mechanism on the hob.
- ▶ Miele will guarantee to supply functional spare parts for a minimum of 10 years and up to 15 years following the discontinuation of your hob.

Sustainability and environmental protection

Energy saving tips when cooking

- Cook in covered pots and pans if possible. This prevents heat escaping unnecessarily.
- Cook with as little water as possible.
- Once food has come to the boil or the pan is hot for frying, reduce the heat to a lower power level.
- Use a pressure cooker to reduce cooking durations.

Disposing of the packaging material

The packaging material is used for handling and protects the appliance from transport damage. The packaging material used is selected from materials which are environmentally friendly for disposal and can generally be recycled.

Recycling the packaging material reduces the use of raw materials. Use material-specific collection points for valuable materials and take advantage of return options. Your Miele dealer will take the packaging material away.

Disposing of your old appliance

Electrical and electronic appliances contain many valuable materials. They also contain certain materials, compounds and components which were essential for their correct functioning and safety. These could be hazardous to human health and to the environment if disposed of with household waste or if handled incorrectly. Please do not, therefore, dispose of your old appliance with household waste.

Instead, please make use of officially designated collection and disposal points to dispose of and recycle electrical and electronic appliances in your local community, with your dealer or with Miele, free of charge. By law, you are solely responsible for deleting any personal data from the old appliance prior to disposal. You are legally obliged to remove any old batteries which are not securely enclosed by the appliance and to remove any lamps without destroying them, where this is possible. These must be taken to a suitable collection point where they can be handed in free of charge. Please ensure that your old appliance poses no risk to children while being stored for disposal.



Safety notes for installation

 Risk of damage from incorrect installation.

Incorrect installation can cause damage to the hob.

The hob must only be installed by a qualified specialist.

 Risk of electric shock from mains voltage.

Incorrect connection to the mains supply may result in an electric shock.

The hob must be connected to the electrical supply by a qualified electrician only.

 Damage from falling objects.

Take care not to damage the hob when fitting wall units or a cooker hood above it.

Fit the wall units and the cooker hood before the hob.

Dismantling the hob for service purposes may damage the sealing strip underneath the edge of the hob.

Always replace the sealing strip before reinstalling.

► The hob must not be installed over refrigeration appliances, dishwashers, washing machines, washer-dryers or tumble dryers.

► This hob may only be installed above a cooker or oven if they have a built-in cooling fan.

► Ensure that the mains connection cable cannot be touched after the hob has been installed.

► After installation, the mains connection cable of the hob must not come into contact with any moving kitchen components (such as a drawer) or be subject to mechanical loads.

► The veneers or laminate coatings of worktops must be treated with 100 °C heat-resistant adhesive so they do not come loose or warp. Any wall strips must be of heat-resistant material.

► Remember to maintain the minimum safety distances.

Additional safety notes for surface-mounted installation

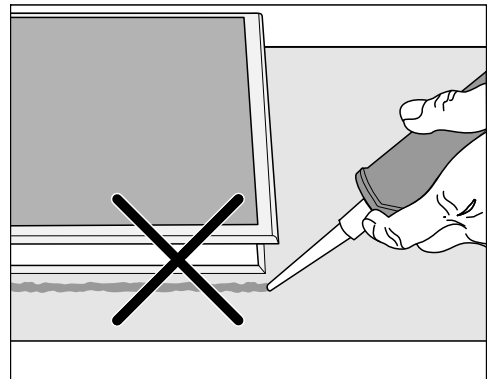

Installation

⚠ Damage caused by incorrect installation.

Using sealant under the hob could result in damage to the hob and the worktop if the hob ever needs to be removed.

Do not use sealant between the hob and the worktop. The sealing strip under the edge of the hob provides a sufficient seal for the worktop.

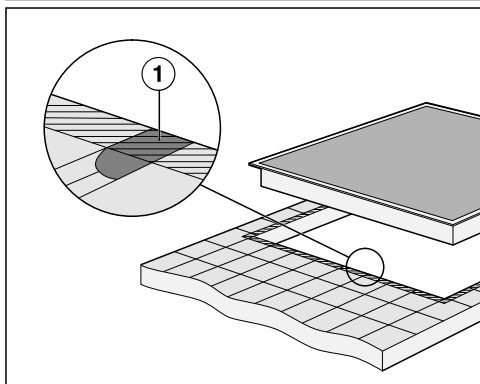

► Grout lines ① and the hatched area underneath the hob frame must be smooth and even. If they are not, the hob will not sit flush with the worktop and the sealing strip underneath the hob will not provide a good seal between the hob and the worktop.

Additional safety notes for flush-fit installation

⚠ Damage caused by using an unsuitable sealant.

Unsuitable sealant can damage natural stone.

For natural stone worktops and natural stone tiles, only use silicone sealant that is temperature-resistant (min. 160 °C) and specially formulated for natural stone. Follow the manufacturer's instructions.

► The internal width of the base unit underneath the appliance must be at least as wide as the inner worktop cut-out so that the hob is easily accessible from below after installation and the casing can be removed for maintenance. If the underside of the hob is not freely accessible after installation, any sealant must be removed to enable the hob to be lifted out.

► A flush-fit hob is suitable only for installation in natural stone (granite, marble), solid wood and tiled worktops. When using a worktop made from any other material, please check first with the worktop manufacturer that the material is suitable for installing a flush-fit hob.

- Natural stone worktops: the hob is set directly in the cut-out.
- Solid wood worktops, tiled worktops: the hob is secured inside the cut-out with wooden battens. The battens must be provided on site and are not included in the scope of delivery.

Safety distances

Safety distance above the hob

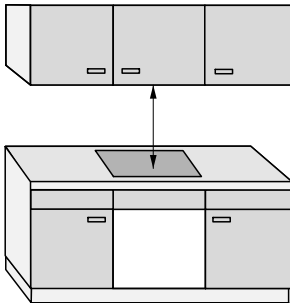

The following must be ensured between the hob and the cooker hood above it:

- The safety distance specified by the manufacturer of the cooker hood must be maintained.
- When two or more appliances which have different safety distances are installed together below a cooker hood, the greatest specified safety distance must be maintained.

If combustible objects are installed above the hob (e.g. cabinets, utensil rail, etc.), a minimum safety distance of 500 mm must be maintained.

Installation

Safety distance behind and to the side of the hob

The minimum safety distances shown below must be maintained between the appliance and a tall unit or wall:

- Between the **back** ① of the worktop cut-out and the rear edge of the worktop:
50 mm
and
- On the **right side** ② between the worktop cut-out and the closest adjacent piece of furniture (e.g. tall unit) or a room wall:
50 mm and on the opposite side a minimum safety distance of 200 mm
or
- On the **left side** ③ between the worktop cut-out and the closest adjacent piece of furniture (e.g. tall unit) or a room wall:
50 mm and on the opposite side a minimum safety distance of 200 mm

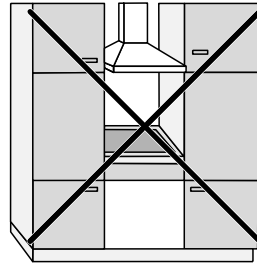

Not permitted

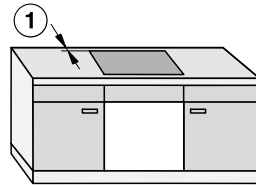
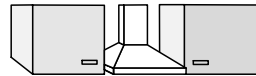

Highly recommended

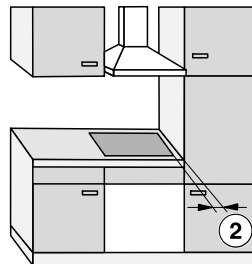

Not recommended

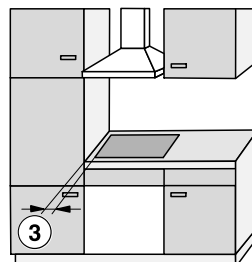

Not recommended

Safety distance underneath the hob

To install the hob while maintaining the safety distances, you can choose from 3 variants:

1. Without intermediate shelf or base panel
2. With intermediate shelf
3. With an air intake-optimised base panel

Further instructions are described in the relevant section.



An air intake-optimised base panel and an intermediate shelf cannot be combined.

If they are combined, more warm air is drawn in. The hob is not adequately cooled.

The hob is ventilated from below. A drawer underneath the hob is heated.

If you wish to install a drawer underneath the hob, we recommend installing the hob with an air intake-optimised base panel to reduce the waste heat from the hob.

Rear panel cut-out

For ventilation and **accommodating the mains connection cable**, you will need to create a cut-out in the rear panel.

Create a cut-out in the rear panel using the following instructions:

Installation

1. Without intermediate shelf or base panel

To ensure sufficient ventilation to the hob, a minimum safety distance must be left between the underside of the hob and any drawer or oven.

The minimum safety distance between the underside¹ of the hob and:

- Upper edge of drawer: ≥ 5 mm
- Base of drawer: ≥ 75 mm
- Upper edge of oven: ≥ 15 mm

¹ The underside is the outside of the hob casing. Other items that are attached lower down, such as connection boxes and shims, do not count as the lowest point and are not relevant when calculating the minimum safety distance.

2. Intermediate shelf

The dimensions shown in brackets are recommendations.

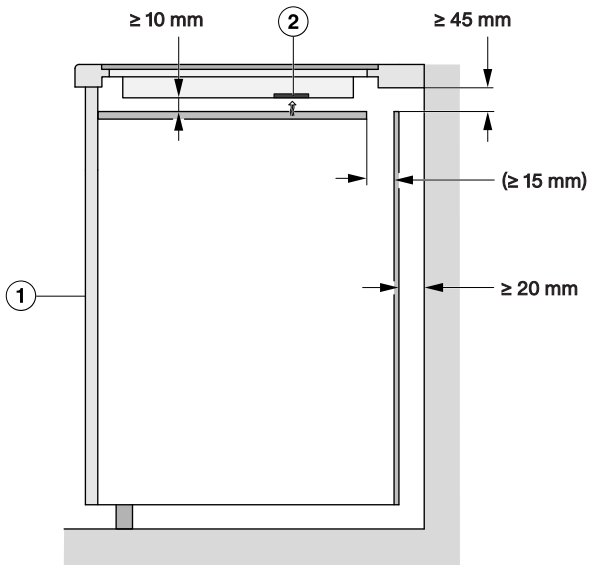

Side view

- ① Front
- ② Fan

3. Air intake-optimised base panel

The performance of the hob depends on the ventilation.

The air intake-optimised base panel has openings where the fans are positioned. This section contains instructions for creating an air intake-optimised base panel.

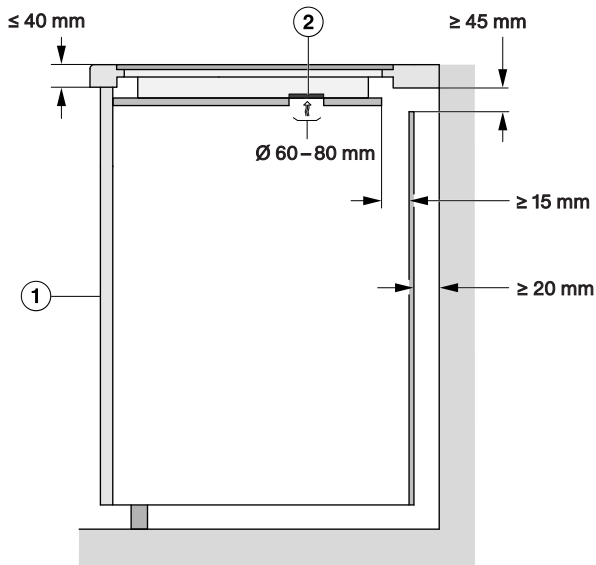

Side view

- ① Front
- ② Fan

To ensure sufficient ventilation to the hob, a minimum safety distance must be left between the underside of the air intake-optimised base panel and any drawer.

Minimum safety distance between the **underside of the air intake-optimised base panel** to the:

- Upper edge of drawer: ≥ 5 mm
- Base of drawer: ≥ 75 mm
- Upper edge of intermediate shelf: not permitted

There must be no gap between the air intake-optimised base panel and the hob. A gap causes more warm air to be drawn in. The hob is not adequately cooled.

Installation

Positions and cut-outs of the ventilation openings

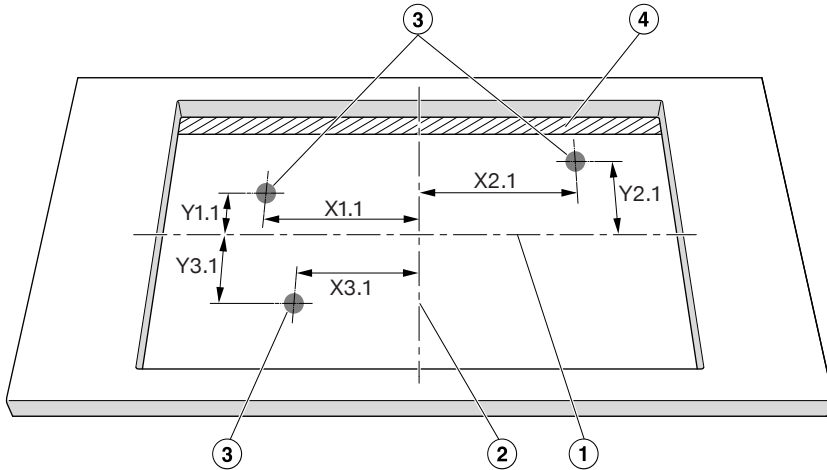

Not to scale. View from above. Surface-mounted cut-out shown. Also applies to flush-fit installation.

- ① Middle of the cut-out height
- ② Middle of the cut-out width
- ③ Cut-out for fan, round (\varnothing 60–80 mm)
- ④ Gap (\geq 15 mm)

	X1.1	Y1.1	X2.1	Y2.1	X3.1	Y3.1
	Distance from the middle of the cut-out in mm					
KM 8484 FR/FL	319	107	13	92	267	97
KM 8486 FX	319	107	13	92	267	97

Position the hob so that the fans are above the cut-outs.

If the fans are not positioned above the cut-outs, the air flow may be obstructed. The hob is not adequately cooled.

Minimum safety distance from the niche cladding

If niche cladding is installed, a minimum safety distance must be maintained between the worktop cut-out and the cladding. High temperatures can alter or damage these materials.

Flush-fit installation

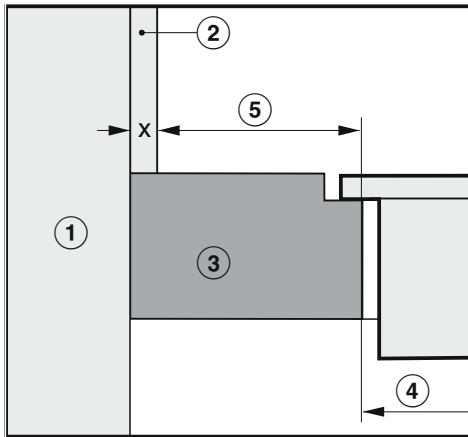

Surface-mounted installation

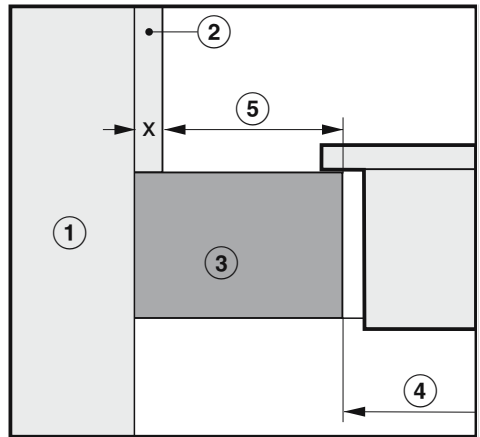

- ① Masonry
- ② Dimension x = thickness of the niche cladding material
- ③ Worktop
- ④ Worktop cut-out
- ⑤ Minimum safety distance to
 - combustible** materials (e.g. wood)
 - non-combustible** materials (e.g. metal, natural stone, ceramic tiles)

Material	Side		Opposite side	
	Combustible	Non-combustible	Combustible	Non-combustible
Back	50 mm	50 mm – dimension x	–	–
Right	50 mm	50 mm – dimension x	200 mm	200 mm – dimension x
Left	50 mm	50 mm – dimension x	200 mm	200 mm – dimension x

Example: 15 mm thick non-combustible niche cladding
 50 mm minus 15 mm = minimum safety distance of 35 mm

Installation

Installation dimensions for surface-mounted installation

KM 8484 FR

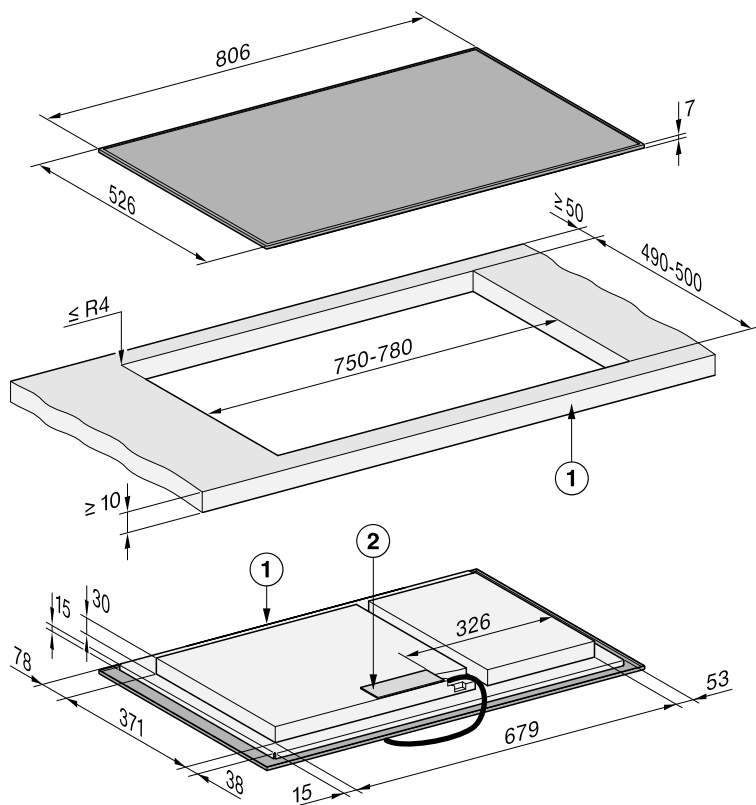

All dimensions are given in mm.

① Front

② Mains connection box

The mains connection cable (L = 1440 mm) is supplied loose

KM 8484 FL

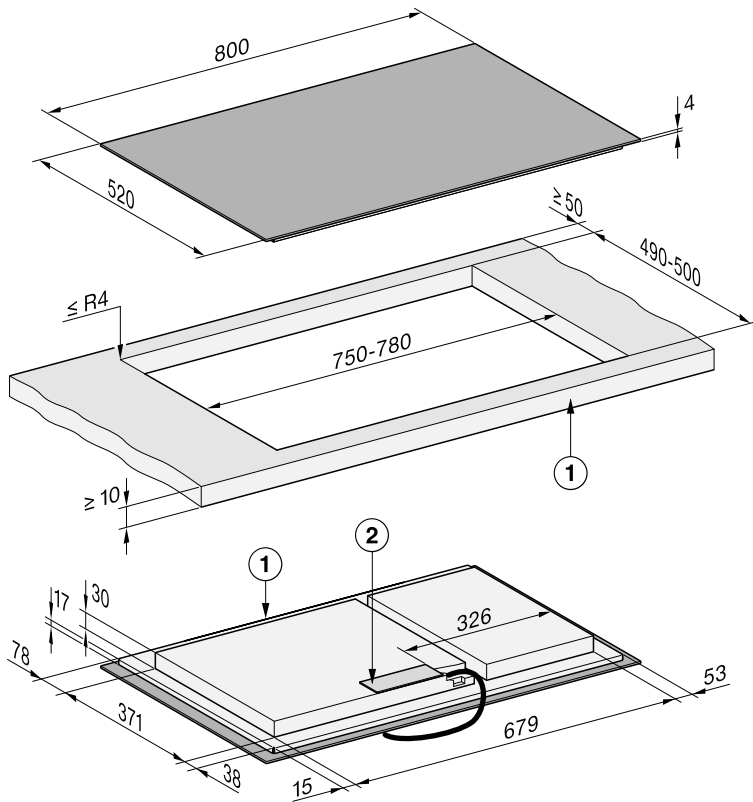

All dimensions are given in mm.

① Front

② Mains connection box

The mains connection cable (L = 1440 mm) is supplied loose

Installation

Installation dimensions for flush-fit installation

KM 8484 FL

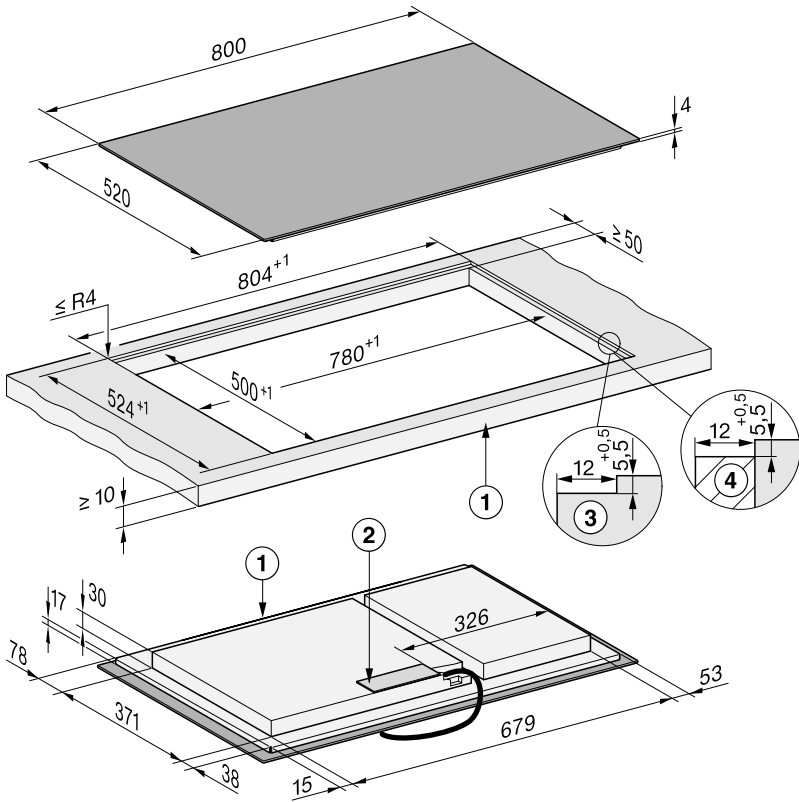

All dimensions are given in mm.

- ① Front
- ② Mains connection box
The mains connection cable (L = 1440 mm) is supplied loose
- ③ Stepped cut-out, natural stone worktop
- ④ Wooden batten 12 mm (accessories not included)

KM 8486 FX

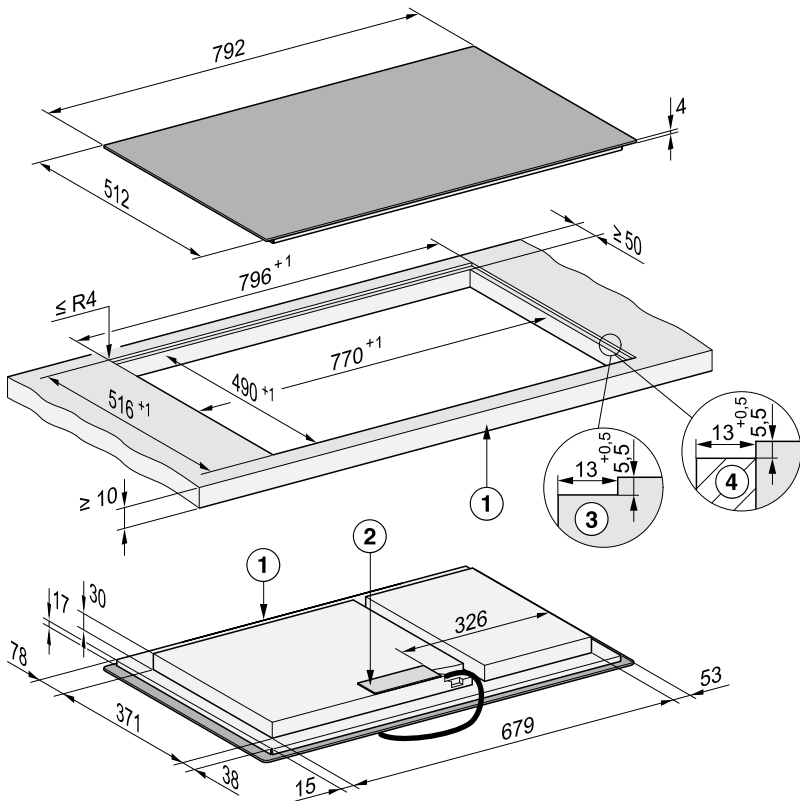

All dimensions are given in mm.

- ① Front
- ② Mains connection box
The mains connection cable (L = 1440 mm) is supplied loose
- ③ Stepped cut-out, natural stone worktop
- ④ Wooden batten 12 mm (accessories not included)

Installation

Installing a surface-mounted hob

Preparing the worktop for surface-mounted installation

- Remember to maintain the minimum safety distances.
- Create the worktop cut-out.
- Wooden worktops:
Seal any cut surfaces with a special varnish, silicone sealant or resin to prevent the wood from swelling as a result of moisture ingress. The sealant must be heat-resistant.

Make sure that the sealant does not come into contact with the top of the worktop.

Installing a surface-mounted hob

The seal ensures that the hob will sit securely in the cut-out without slipping. Any gap between the appliance frame and worktop will become smaller over time.

- Attach the sealing strip included in the scope of delivery underneath the edge of the hob. The joint edge (start and end) of the sealing strip must not be in a corner. Apply some silicone joint sealant to the joint edge of the sealing strip. Do not apply the sealing strip under tension.

 Risk of damage from incorrect connection.

The hob electronic module may be damaged if a short-circuit occurs. The mains connection cable must be connected to the hob by a qualified electrician.

- Follow the instructions in the wiring diagram to connect the mains connection cable to the hob.
- Feed the mains connection cable for the hob down through the worktop cut-out.
- Place the hob centrally in the cut-out. When doing this, make sure that the seal of the appliance sits flush with the worktop on all sides. This is important to ensure effective sealing all round.
- If the seal does not sit flush with the worktop in the corners, the corner radius ($\leq R4$) can be carefully cut to fit using a jigsaw.
- If an air intake-optimised base panel is installed, position the hob so that the fans are located above the cut-outs.
- Connect the hob to the electricity supply.
- Check that the hob is working.

Installing the hob flush with the worktop

Preparing the worktop for flush-fit installation

- Remember to maintain the minimum safety distances.
- Create the worktop cut-out.
- Solid wood and tiled worktops:
Secure the wooden frame 5,5 mm below the top edge of the worktop.

Installing a flush-fit hob

The seal ensures that the hob will sit securely in the cut-out without slipping. Any gap between the appliance frame and worktop will become smaller over time.

- Attach the sealing strip included in the scope of delivery underneath the edge of the hob. The joint edge (start and end) of the sealing strip must not be in a corner. Apply some silicone joint sealant to the joint edge of the sealing strip. Do not apply the sealing strip under tension.

 Risk of damage from incorrect connection.

The hob electronic module may be damaged if a short-circuit occurs. The mains connection cable must be connected to the hob by a qualified electrician.

- Follow the instructions in the wiring diagram to connect the mains connection cable to the hob.
- Feed the mains connection cable for the hob down through the worktop cut-out.

The gap between the ceramic surface and the worktop must be at least 2 mm wide.

This is required so that the hob can be sealed.

- Centre the hob in the cut-out.
- If an air intake-optimised base panel is installed, position the hob so that the fans are located above the cut-outs.
- Connect the hob to the mains power supply.
- Check that the hob is working.
- Seal the gap between the hob and worktop with a suitable silicone sealant that is heat-resistant to at least 160 °C.

Electrical connection

 Risk of damage from incorrect connection.

Unauthorised installation, maintenance and repairs can cause considerable danger for the user.

Miele cannot be held liable for damage or injury caused by unauthorised installation, maintenance or repair work, or by an inadequate or faulty on-site earthing system (e.g. electric shock).

This hob must be connected to the mains power supply by a qualified electrician.

The qualified electrician must be familiar with and comply with the national regulations and any additional regulations of the local electricity provider.

After installation, ensure that all electrical components are shielded and cannot be accessed by users.

Total power rating

See data plate

Connection data

The connection data is quoted on the data plate. Please ensure these match the household mains supply.

Please see wiring diagrams for connection. (N.B. This appliance is supplied single phase only in the UK / AUS / NZ).

Residual current device

For extra safety, it is advisable to protect the hob with a suitable residual current device (RCD) with a trip range of 30 mA.

Installation

Disconnecting devices

It must be possible to disconnect the hob from the mains at all poles using disconnecting devices. A contact distance of at least 3 mm must be observed in the switched-off state. The disconnecting devices include overcurrent protection devices and residual current protection devices.

Disconnecting from the mains

 Risk of electric shock from mains voltage.

There is a risk of electric shock if the appliance is reconnected to the mains voltage supply during repair or service work.

After disconnection, ensure the appliance cannot be switched back on by mistake.

To disconnect the appliance from the mains power supply, do one of the following depending on installation:

Fine-wire fuses

- Completely remove the fuse links from the screw caps.

Automatic circuit breakers

- Press the test button (red) until the middle button (black) springs out.

Built-in circuit breakers

- For circuit breakers of at least type B or C, switch the lever from 1 (on) to 0 (off).

Residual current device

- Residual current device: switch the main switch from 1 (on) to 0 (off) or press the test button.

Mains connection cable

The hob must be connected to the electrical supply with a special connection cable, type H 05 VV-F (PVC insulated) with a suitable diameter.

Please see wiring diagrams for connection.

See the data plate on the hob for the correct voltage and rated load.

Replacing the mains connection cable

 Risk of electric shock.

Incorrect connection to the power supply may result in an electric shock.

The mains cable must only be replaced by a qualified electrician.

When replacing the mains cable only use cable type H 05 VV-F (PVC insulated) with a suitable cross section. A suitable connection cable is available to order from Miele.

Wiring diagram

Some connection methods are not permitted in all installation locations.

Ensure compliance with national regulations and any additional regulations issued by the local electricity provider.

The maximum load per connected live conductor is 3650 W.

The first and second live conductors are required for connecting the hob. Further appliances can be connected to the third live conductor.

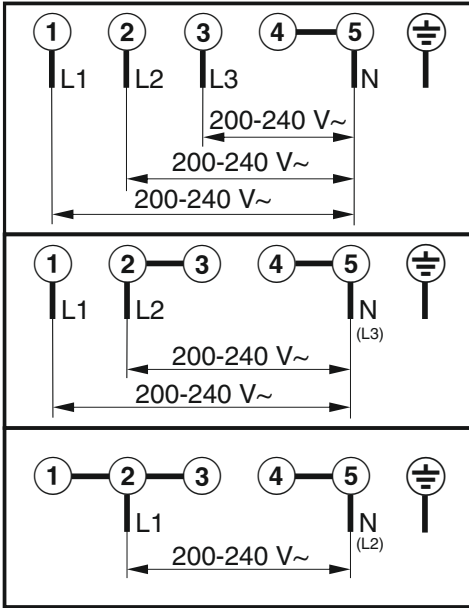

Familiarisation

Your hob

KM 8484 FR, KM 8484 FL, KM 8486 FX

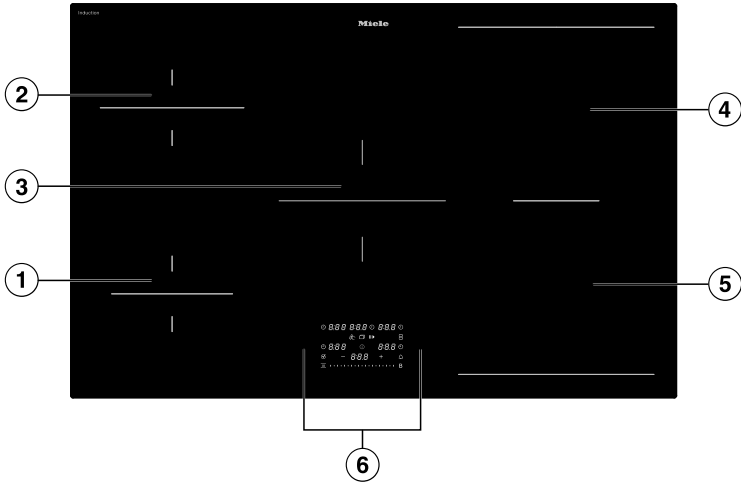

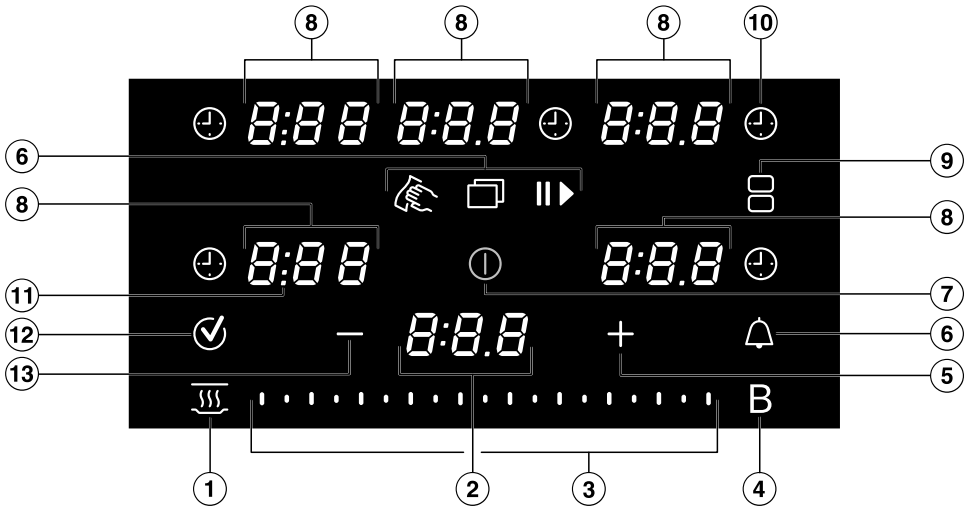

- ① Cooking zone with Booster function
- ② Cooking zone with Booster function
- ③ Cooking zone with Booster function
- ④ PowerFlex cooking zone with Booster can be combined with PowerFlex cooking zone ⑤ to form PowerFlex XL cooking area
- ⑤ PowerFlex cooking zone with Booster

Controls and indicators



- ① *Keeping warm* sensor control
To activate/deactivate the Keeping warm special function
- ② Hob display
0:00–9:59 Time
LOC On/OFF System lock/Keypad lock is activated/deactivated
dE On/OFF Demo mode is activated/deactivated
UP A software update is available.
- ③ Slider
– To set the power level
– To set the times
- ④ *Booster B* sensor control
- ⑤ *Plus +* sensor control
– To adjust the settings
– To adjust the times
- ⑥ *Menu* sensor control to display the following sensor controls
 Wipe protection sensor control to lock the control elements and indicators for 20 seconds
 Timer sensor control: an alarm for activities that are independent of the hob
 Stop&Go sensor control to stop/start a cooking process in progress

Familiarisation

- ⑦ *On/Off* ① sensor control
- ⑧ Cooking zone display
 - 0* Cooking zone is ready for operation
 - 1.0 to 9.0* Power level
 - 0:00–9:59* Time
 - Residual heat indicator level 1
 - Residual heat indicator level 2
 - ≡* Residual heat indicator level 3
 - u* Cookware missing or unsuitable
 - b* Booster
 - h* Keeping warm
- ⑨ Sensor control for *PowerFlex XL* cooking zones 
To link/unlink PowerFlex XL cooking zones manually
- ⑩ Sensor control for *Duration* of a cooking process 
Switches the cooking zones off automatically after a set period of time
Measures the time a cooking process takes
- ⑪ Separator display
Display of intermediate power levels
- ⑫ *OK*  sensor control
- ⑬ *Minus* — sensor control
 - To adjust the settings
 - To adjust the times

Cooking zone data

KM 8484 FR, KM 8484 FL, KM 8486 FX					
Cooking zone	Size in cm ¹		Max. rating in watts for 230 V ²		Linked cooking zone ³
	∅				
①	10–16	–	Normal Booster	1400 2200	⑤
②	12–19	–	Normal Booster	1850 3000	④
③	14–22	–	Normal Booster	2300 3650	-
④	12–23	12 x 12 – 23 x 19	Normal Booster	2100 3650	②
⑤	12–23	12 x 12 – 23 x 19	Normal Booster	2100 3650	①
④ + ⑤	–	22 x 22 – 23 x 46	Normal Booster	3400 7300	-
			Total	7300	

¹ Cookware with a base diameter or surface (width x depth) within the given range may be used.

² The rating given may vary depending on the size and material of the cookware used.

³ The cooking zone is linked to this cooking zone electrically so that the rating can be increased.

Familiarisation

Power management

Total permitted power consumption

The hob has a maximum total permitted power consumption which cannot be exceeded for safety reasons. You can reduce the maximum total permitted power consumption.

The higher the total permitted power consumption of the hob, the more power levels/special functions can be used on all cooking zones at the same time.

If the set power levels/special functions require more power than can be provided in accordance with the total permitted power consumption, the hob will distribute the maximum permitted power between the cooking zones.

Distribution of power

Cooking zones can be linked together in pairs on the hob. This allows power to be transferred from one cooking zone (A) to another (B). As a result, the power of cooking zone (A) is reduced.

Example: the Booster function for cooking zone (B) is activated.

Cooking zone (B) which requires additional power is determined by the most recent setting on the hob.

The values for the maximum total permitted power consumption and which cooking zones are linked together can be found in the cooking zone data.

You can reduce the maximum total permitted power consumption.

Effects of power distribution

If a cooking zone gives power to another zone, this can have the following effects on the zone giving the power:

- The power level is reduced.
- Auto heat-up is deactivated. Cooking continues at the set level. If the power is not sufficient, the power level will be reduced again.
- The Booster function is deactivated.
- The cooking zone is switched off.

When the cooking zone stops transferring power to another zone, the power level can be increased again.

Tip: If you wish to cook a large quantity of food on one cooking zone, switch the other cooking zones to lower power levels.

Operation

Hob when switched off

Only the printed symbol for the On/Off ① *On/Off* sensor control is visible when the hob is switched off. More sensor controls light up when the hob is switched on.

Operation

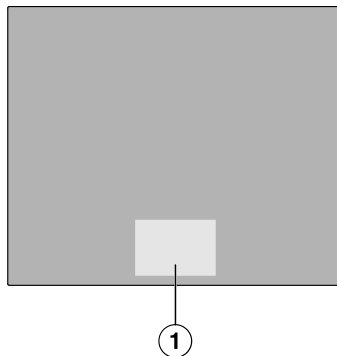

① Area for sensor controls and displays

This ceramic glass hob is equipped with sensor controls which react to finger contact.

Each time a sensor control is activated, a buzzer sounds.

For safety reasons, the On/Off  On/Off sensor control needs to be touched for a little longer than the other sensors in order to switch the appliance on.

Selecting a cooking zone

If you want to configure settings for a cooking zone, the cooking zone must be selected first. To select a cooking zone, touch the corresponding Cooking zone display. After you touch the Cooking zone display, it lights up brightly. When the Cooking zone display appears bright, the cooking zone is selected and you can configure settings for the cooking zone. If cookware is detected on the other cooking zones, the other cooking zone indicators light up dimly. **Exception:** if only one of the cooking zones is in operation, you can configure settings without selecting the cooking zone.

Networking

Your hob is equipped with an integrated WiFi module. The hob can be connected to your home network or just to your Miele cooker hood. The WiFi module enables the Miele app to be used on a mobile device.

Once your hob has been connected via WiFi, the connection is automatically re-established every time it is switched on.

Make sure that your WiFi network signal is strong enough in the place where you intend to install your hob.

Connecting your hob to your WiFi network will increase energy consumption, even when the hob is switched off.

Smart Extras via the Miele app*

Networking via the Miele app gives you access to numerous Smart Extras, including:

- Access status information.
- Use additional helpful functions.
- Keep your hob up to date with the latest Miele developments via software updates (only possible via WiFi connection).

You can find more detailed information about Smart Extras on the Miele website, in the Apple App Store® or in the Google Play Store™.

*This is a separate digital offer from Miele & Cie. KG. The range of functions can vary depending on the model and the country. Acceptance of the Terms and Conditions and Privacy Policy for Miele digital products & services in the Miele app required. Miele reserves the right to change or discontinue the digital offer at any time.

Special functions

Controlling a cooker hood

Con@ctivity 3.0

Con@ctivity 3.0 is the direct communication system between your hob and a Miele cooker hood. Communication is achieved by means of networking.

Familiarisation

Con@ctivity 3.0 enables the cooker hood to operate automatically depending on the operating status of your hob.

The Con@ctivity versions of the hob and cooker hood must match.

Further information can be found in the operating and installation instructions for your cooker hood.

Permanent pan recognition

When you place cookware on a cooking zone, the Slider is activated automatically.

Pan size recognition

The size of the cookware is detected within a cooking zone. The release of energy is adapted to the size of the pan.

PowerFlex XL cooking area

A PowerFlex XL cooking area links together 2 PowerFlex cooking zones, making it possible to use larger cookware.

The PowerFlex cooking zones link automatically to form a PowerFlex XL cooking area when you place sufficiently large items of cookware on them. The PowerFlex cooking zones can also be linked manually.

Hob Booster

When the Booster function is activated, the power is boosted so that large quantities can be heated up quickly, e.g. when boiling water for cooking pasta.

Stop&Go

When Stop&Go is activated, all power levels are reduced to 1.

When the function is deactivated, the appliance switches back to the power level that was set last.

Tip: Use this special function if there is a danger of food boiling over.

Hob power levels

You can set the power for the cookware in levels from 1 to 9.

There is an intermediate level between each power level. The intermediate levels allow you to fine-tune the power settings.

If you do not need the intermediate levels, you can deactivate the intermediate levels via the settings.

Auto heat-up

When auto heat-up has been activated, the cooking zone switches on automatically at the highest setting (heat-up boost) and then switches to the power level (continued cooking setting) which you have previously selected.

Timer functions

There are 3 timer functions:

- Timer
- Duration of a cooking process
- Elapsed time of a cooking process

You can use the functions simultaneously.

Timer

You can set an alarm for activities that are independent of the hob.

Duration of a cooking process

You can set a time after which a cooking zone will switch off automatically. This function can be used for all cooking zones at the same time.

Elapsed time of a cooking process

You can measure how long a cooking process takes.

System lock

If the system lock is activated, then the hob cannot be switched on.

Keypad lock

The keypad lock is activated when the hob is switched on. When the keypad lock is activated, the hob can be operated only under certain conditions.

Recall

If the hob is switched off by mistake during use, this special function can be used to restore all settings.

Keeping warm

This special function enables food to be kept warm after it has finished cooking.

Wipe protection

The hob sensor controls can be locked for 20 seconds to remove soiling, for example. Ⓛ *On/Off* is not locked.

Settings

You can adapt the settings of the hob to your personal needs.

Demo mode

This special function enables the hob to be demonstrated in dealer showrooms without heating up.

Residual heat indicator

If a cooking zone is still hot, the residual heat indicator will light up after all cooking zones have been switched off.

The bars of the residual heat indicator go out one after the other as the cooking zone cools down. The last bar only goes out when the cooking zone is safe to touch.

Safety switch-off

Sensor controls are covered

Your hob will switch off automatically if one or several of the sensor controls remain covered for longer than 10 seconds; for example, by finger contact, food boiling over or by an object. Ⓛ will flash briefly in the Hob display and a buzzer will sound.

Ⓛ will go out once you have removed the obstruction and/or soiling and the hob will be ready to use again.

Excessive operating time

The safety switch-off is triggered automatically if a cooking zone is heated for an unusually long period of time. This time depends on the power level selected. If it has been exceeded, the cooking zone switches off and the residual heat indicator appears. If you switch the cooking zone off and on again, it is ready for operation again.

You can adjust the safety switch-off by changing the safety setting.

Familiarisation

Special function/ power level	Maximum operating time [h:min]		
	Safety setting		
	0 ¹	1	2
Keeping warm	2:00	2:00	2:00
1.0	10:00	8:00	5:00
1.5	10:00	7:00	4:00
2.0/2.5	5:00	4:00	3:00
3.0/3.5	5:00	3:30	2:00
4.0/4.5	4:00	2:00	1:30
5.0/5.5	4:00	1:30	1:00
6.0/6.5	4:00	1:00	0:30
7.0/7.5	4:00	0:42	0:24
8.0	4:00	0:30	0:20
8.5	4:00	0:30	0:18
9.0	1:00	0:24	0:10

¹ Factory default setting

Overheating protection

In order to prevent the hob from being damaged by excessive temperatures, the overheating protection mechanism intervenes in one of the following ways:

Overheating protection measures

- If the Booster function is switched on, it will stop.
- The set power level will be reduced.
- A cooking zone will switch off. *Err* flashes alternately with *044* in the Hob display.
- All cooking zones will switch off.

Triggering the overheating protection mechanism

The overheating protection mechanism may be activated under the following circumstances:

- The cookware being heated is empty.
- Fat or oil is being heated on a high power level.
- Insufficient ventilation to the underside of the hob.
- A hot cooking zone is switched back on after an interruption to the power supply.

Model identifier and serial number

Your hob can display the model identifier and serial number.

Software version

Your hob can display its software status.

Software update

To receive updates, you must be connected to your home network.

A message will appear on the Hob display as soon as a new update is available.

When it comes to updates, you can:

- Install them immediately
- Postpone them and carry out at a later date
- Switch them off permanently

If you do not install an update or install it later, you can continue to use your hob as usual. However, Miele recommends installing the updates as soon as possible.

Optional accessories

Products specially tailored to your hob – such as cookware and cleaning agents – are available from the Miele online shop, Miele Customer Service or your Miele specialist dealer.

You can access the Miele online shop via the following QR code:



Commissioning

Unpacking the hob

- Please stick the data plate for the appliance, supplied with this documentation, in the space provided in the “After sales service” section of this booklet.
- Remove any protective foil and stickers.

Cleaning the hob for the first time

- Before using for the first time, clean the hob with a damp cloth.
- Wipe the hob dry.

Switching on the hob for the first time

The metal components have a protective coating. When the hob is used for the first time, this causes a smell and possibly also vapour. The heating of the induction coils also causes odours in the first few hours of operation. With each subsequent use, the odour is reduced until it disappears completely.

The odour and any vapours given off do not indicate a faulty connection or appliance and they are not hazardous to health.

Networking

You can use your hob:

- To connect to your home network with your mobile device
- To network directly with your Miele cooker hood

Both types of networking allow you to control your cooker hood.

Networking with your mobile device allows you to utilise additional functions. See “Familiarisation – Networking” for more information.

Requirements for networking with your home network

Note the following requirements for networking:

1. A home network is available at the installation site.
Have the WiFi password ready.
2. The Miele app is available on a mobile device.
3. You have a user account in the Miele app.
4. There is no direct WiFi connection between the hob and your Miele cooker hood.

You have 2 options for connecting your hob to the home network:

- NFC
- Scan & Connect

Both options lead to the same result.

Using NFC

The NFC function on your mobile device is activated.



- Switch the hob on.
- Move your mobile device gently over the  *NFC icon* display at a distance of ≤ 1 cm.

If you have installed the Miele app and have a user account, you will be taken directly to the networking steps.

If you have not yet installed the Miele app, you will be taken to the Apple App Store® or the Google Play Store™.

- Install the Miele app and set up a user account.
- Once again, move your mobile device gently over the  *NFC icon* display at a distance of > 1 cm.

The Miele app will guide you through the setup process.

Tip: If you cannot find the  *NFC icon* display on your hob, access the model identifier, for example. The display  *NFC icon* will then light up.

Performing Scan & Connect



- Scan the QR code.

If you have installed the Miele app and have a user account, you will be taken directly to the networking steps.

If you have not yet installed the Miele app, you will be taken to the Apple App Store® or the Google Play Store™.

- Install the Miele app and set up a user account.
- Scan the QR code again.

The Miele app will guide you through the setup process.

Requirements for direct networking with your Miele cooker hood



Note the following requirements for networking:

1. Your Miele cooker hood has Con@ctivity 3.0.
2. The hob is not networked with your home network.

Networking your hob with your Miele cooker hood

You can find the necessary information on connecting the cooker hood in the associated operating and installation instructions.

- Start the connection setup on the cooker hood.
- Switch the hob on.

If the connection was successful, the code  appears in the Hob display. If the connection could not be established, the Hob display will show the code . Repeat the steps above.

Con@ctivity 3.0 is now activated.

Resetting settings

- Reset the settings when you switch from one networking option to another.
- Reset the settings if you are disposing of your hob, selling it or putting a used hob into operation. This is the only way to ensure that all personal data has been removed and the previous owner will no longer be able to access the hob.

Resetting is not required when replacing the router.

- Switch the hob off.
- Touch  *On/Off* for approx. 6 seconds. The seconds can be seen counting down in the Hob display.

The Hob display shows *P*.

The Cooking zone displays show the following:

Commissioning

- 9 and a number indicate the selected quick parameter.
- Depending on the model:
 - £ and a number indicate the selected code of the selected quick parameter.

Other sensor controls light up.

The (NFC icon) *NFC icon* display lights up brightly.

- Touch + *Plus* or the Slider repeatedly until the Cooking zone display at the back right shows the following: 909
- Touch ✓ *OK*.
- Touch + *Plus* repeatedly until the Cooking zone display show the following: £01
- Touch ✓ *OK*.
- Touch + *Plus* repeatedly until the Cooking zone display shows the following: £01
- Touch ✓ *OK*.

The WiFi settings are reset. £01 is displayed in the Cooking zone displays.

Safety notes for operation

 Risk of fire due to overheated food.

Unattended food can overheat and catch alight.

Do not leave the hob unattended whilst it is being used.

 Risk of burning due to hot cooking zones.

The cooking zones will be hot after use.

Do not touch the cooking zones while the residual heat indicators are on.

 Risk of burning due to hot items.

When the hob is switched on either deliberately or by mistake, or when there is residual heat present, there is the risk of metal items placed on the hob heating up.

Do not use the hob as a resting place for anything.

After use, switch the hob off with the  sensor control.

 Placing hot cookware on the sensor controls and displays can damage the electronic module underneath.

The sensor controls do not respond.

They may be switched on or off unintentionally.

The hob switches itself off.

Do not place hot cookware over the sensor controls or displays.

► Never heat pans with a non-stick coating with the Booster.

Switching the hob on

■ Touch  *On/Off*.

Other sensor controls light up.

If no further entry is made, the hob will switch itself off after a few seconds for safety reasons.

Switching the hob/a cooking zone off

Switching the hob off

■ To switch off the hob and all the cooking zones, touch  *On/Off*.

Switching a cooking zone off

■ To switch off a cooking zone, touch the corresponding Cooking zone display.

The Cooking zone display lights up brightly. The other Cooking zone display lights up dimly.

■ Touch  on the Slider.

Operation

Positioning cookware on PowerFlex XL cooking areas

Refer to the cooking zone data for your hob model for information about cookware sizes and the corresponding positions.

- Position the cookware as shown below:

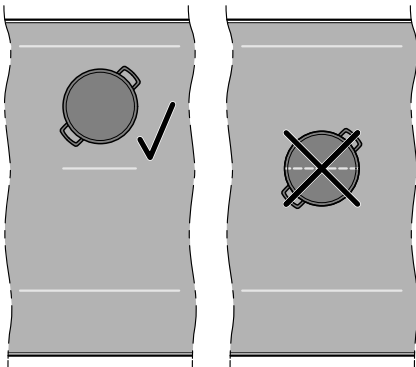

PowerFlex XL cooking zone

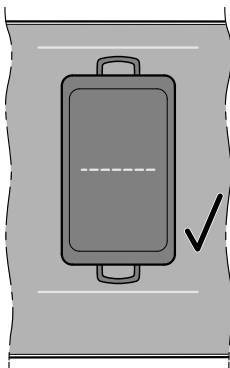

PowerFlex XL cooking area 1

¹ Permanent pan recognition is activated as standard. If you position the cookware correctly, you can control the PowerFlex XL cooking area by operating the front cooking zone.

Hob power levels

Setting the power level for a cooking zone

Permanent pan recognition is activated as standard. When the hob is switched on and you place an item of cookware on a cooking zone, the Cooking zone display lights up brightly.

- Place the cookware on the cooking zone you want to use.

The corresponding Cooking zone display lights up brightly.

- Swipe to the right or left on the Slider until the corresponding Cooking zone display shows the required power level.

The power level is displayed in the corresponding Cooking zone display.

Setting the power level for a cooking zone – without intermediate levels

Permanent pan recognition is activated as standard. When the hob is switched on and you place an item of cookware on a cooking zone, the Cooking zone display lights up brightly.

The setting range for the power levels without intermediate levels has been selected in the settings.

- Place the cookware on the cooking zone you want to use.

The corresponding Cooking zone display lights up brightly.

- Swipe to the right or left on the Slider until the corresponding Cooking zone display shows the required power level.

The power level is displayed in the corresponding Cooking zone display.

Changing the power level for a cooking zone

- Touch the corresponding Cooking zone display.

The Cooking zone display lights up brightly.

- Swipe to the right or left on the Slider until the corresponding Cooking zone display shows the required power level.

The power level is changed in the corresponding Cooking zone display.

PowerFlex XL cooking area

Linking/unlinking PowerFlex cooking zones manually

The PowerFlex/PowerFlex XL special function cannot be operated together with activated M Sense cookware.

At least one PowerFlex cooking zone is selected.

- To manually link or unlink the PowerFlex cooking zones, touch the  *PowerFlex XL*.

Booster

Activating the Booster

The Booster special function cannot be operated together with activated M Sense cookware.

Permanent pan recognition is activated as standard. When the hob is switched on and you place an item of cookware on a cooking zone, the Cooking zone display lights up brightly.

When the Booster is activated, the settings for the linked cooking zone may be changed.

You can use the Booster:

- On any cooking zone on either side or
- On both cooking zones on one side or
- On a PowerFlex cooking area

The Booster function is active for a maximum of 15 minutes.

- Place the cookware on the cooking zone you want to use.

The corresponding Cooking zone display lights up brightly.

- Select a power level if necessary.
- Touch B *Booster*.

The Cooking zone display shows *b*.

Deactivating the Booster

- Touch B *Booster*.

or

- Set another power level.

If you deactivate the Booster function or the Booster time comes to an end and

- no power level was selected before activating the Booster, the cooking zone will revert automatically to level 9.
- a power level was selected before activating the Booster, the cooking zone will revert automatically to the previously selected level.

Activating/deactivating Stop&Go

All timer functions, booster times and heat-up boost times continue to run. The timer settings cannot be changed. The hob can only be switched off.

Operation

If the special function is not deactivated within 1 hour, the hob will switch off.

- Touch  *Menu*.
- Touch **II** ▶ *Stop&Go*.

The active cooking zones are reduced from the set power level to power level 1.0 or switched back again.

Cooking zones with Keeping warm function are not changed.

Auto heat-up

The heat-up time depends on which continued cooking setting has been chosen:

Continued cooking setting	Heat-up time [min:sec] ¹
1.0	Approx. 0:15
1.5	Approx. 0:15
2.0	Approx. 0:15
2.5	Approx. 0:15
3.0	Approx. 0:25
3.5	Approx. 0:25
4.0	Approx. 0:50
4.5	Approx. 0:50
5.0	Approx. 2:00
5.5	Approx. 5:50
6.0	Approx. 5:50
6.5	Approx. 2:50
7.0	Approx. 2:50
7.5	Approx. 2:50
8.0	Approx. 2:50
8.5	Approx. 2:50
9.0	—

¹ If the cookware is temporarily removed from the cooking zone during the heat-up time, the heat-up time is extended by the time without cookware.

Activating auto heat-up

No timer functions can be set during the heat-up time. If an elapsed time display is running, it is cancelled.

- Touch the Cooking zone display for the cooking zone you want to use.
- Hold down the required continued cooking setting on the Slider for approx. 3 seconds until a buzzer sounds.

The power level pulsates while the heat-up boost (power level 9) is running.

Deactivating auto heat-up

- Touch the Cooking zone display for the cooking zone you want to use.
- Set another power level.

or

- Set the same power level again.

Timer functions

There are 3 timer functions:

- Timer
- Duration of a cooking process
- Elapsed time of a cooking process

You can use the functions simultaneously.

Setting the time

A time of between 1 minute (0:01) and 9 hours 59 minutes (9:59) can be set.

- Times of up to 10 minutes are shown in minutes and seconds.
- Durations of up to 59 minutes are shown in minutes.
- Times of more than 60 minutes are shown in hours and minutes.

The time is entered using the Slider and can be adjusted using the + *Plus* and - *Minus*.



- Move the slider to the left or right until the required time is shown in the Hob display or in the corresponding Cooking zone display.

Example:

59 minutes = 00:59 hours,

80 minutes = 1:20 hours

Setting the timer

- Touch  *Menu*.
- Touch  *Timer*.

The Hob display lights up brightly.

 *Timer* lights up brightly and pulsates. Other sensor controls and displays light up dimly.

- Set the required time.

Touch  *Timer* or wait 5 seconds to start the timer.

 *Timer* will start to flash 10 seconds before the time has elapsed.

Changing the timer

- Touch  *Timer*.

The Hob display lights up brightly.

 *Timer* lights up brightly and pulsates. Other sensor controls and displays light up dimly.

- Set the required time.

Touch  *Timer* or wait 5 seconds to start the timer.

Deleting the timer

- Hold down  *Timer* until the set time is no longer shown in the Hob display.

or

- Set the timer to the value 0:00.

Setting the duration of a cooking process

A cooking zone will switch off when the maximum operating time has elapsed, regardless of the duration that has been set.

Operation

- A power level is set for the desired cooking zone.
- No elapsed time is measured.

- Briefly (< 1.5 seconds) touch the \ominus *Duration* next to the corresponding Cooking zone display.

The corresponding Cooking zone display lights up brightly and \ominus *Duration* pulsates. Other sensor controls and displays light up dimly.

- Set the required time.

Touch \ominus *Duration* or wait 5 seconds to start the duration.

The duration of a cooking process runs down and \ominus *Duration* lights up constantly.

The corresponding \ominus *Duration* will start to flash 10 seconds before the time has elapsed.

Changing the duration of a cooking process

- Briefly (< 1.5 seconds) touch \ominus *Duration* for the cooking zone you want to use.

The corresponding Cooking zone display lights up brightly and \ominus *Duration* pulsates. Other sensor controls and displays light up dimly.

- Set the required time.

Touch \ominus *Duration* or wait 5 seconds to start the duration.

The duration of a cooking process runs down and \ominus *Duration* lights up constantly.

Deleting the duration of a cooking process

- Hold down \ominus *Duration* for the cooking zone you want to use until the corresponding Cooking zone display shows 0:00.

or

- Touch \ominus *Duration* for the cooking zone you want to use.

The corresponding Cooking zone display lights up brightly. Other sensor controls and displays light up dimly.

- Touch $\bar{\square}$ on the Slider.

Setting a duration for further cooking processes

- To set a duration for a further cooking process, follow the same steps as described under “Operation – Setting the duration of a cooking process”.

Starting elapsed time measurement of a cooking process

- A power level is set for the desired cooking zone.
- A duration must not be set for the cooking zone.

- Touch and hold (> 1.5 seconds) \ominus *Duration* next to the corresponding Cooking zone display.

The Cooking zone display shows the time that has elapsed since activation.

Cancelling elapsed time measurement of a cooking process

- Hold down \ominus *Duration* for the cooking zone you want to use until the corresponding Cooking zone display shows 0:00.

Starting elapsed time measurement of further cooking processes

- To set an elapsed time for a further cooking process, follow the same steps as described under “Operation – Starting elapsed time measurement of a cooking process”.

Switching between the power level display and timer function display



- Touch the required Cooking zone display to switch between the timer function display and the power level display for a cooking zone.

System lock

Activating the system lock

All sensor controls are locked. A set timer continues to run.

- The hob is switched on.
- All cooking zones are switched off.

- Touch  *Menu*.
- Touch and hold  *Timer* and **||▶ Stop&Go** for 6 seconds.

The seconds can be seen counting down in the Hob display. Once the time has elapsed, the Hob display shows *L0C* alternating with *0n*. The system lock is activated.

If a disallowed sensor control is touched while the system lock is activated, the Hob display will show *L0C* alternating with *0n* for a few seconds. A buzzer sounds.

The settings can be adjusted so that the system lock is activated automatically 5 minutes after the hob has been switched off.

Deactivating the system lock

- Touch and hold  *Timer* and **||▶ Stop&Go** for 6 seconds.

The seconds can be seen counting down in the Hob display. Once the time has elapsed, the Hob display shows *L0C* alternating with *0FF*. The system lock is deactivated.



Keypad lock

Activating the keypad lock

When the keypad lock is activated, only the following actions can be performed:

- The cooking zones and the hob can only be switched off.
- A set timer can be changed.

At least one cooking zone is switched on.

- Touch  *Menu*.
- Touch and hold  *Timer* and **||▶ Stop&Go** for 6 seconds.

The seconds can be seen counting down in the Hob display. Once the time has elapsed, the Hob display shows *L0C* alternating with *0n*. The keypad lock is activated.

If a disallowed sensor control is touched while the keypad lock is activated, the Hob display will show *L0C* alternating with *0n* for a few seconds. A buzzer sounds.

Operation

Deactivating the keypad lock

- Touch and hold  *Timer* and  *Stop&Go* for 6 seconds.

The seconds can be seen counting down in the Hob display. Once the time has elapsed, the Hob display shows *LDC* alternating with *OFF*. The keypad lock is deactivated.

Recall

Activating the Recall function

The hob must be switched on again within 10 seconds of being switched off.

- Switch the hob on again.
- Immediately after switching the hob on, touch one of the flashing Cooking zone displays.

All settings are restored.



Discarding the Recall function

- Switch the hob on again.
- Immediately after switching the hob on, touch one of the Cooking zone displays that are **NOT** flashing.

The new setting is applied; all other settings are discarded.

Wipe protection

Activating wipe protection

- Touch  *Menu*.
- Touch  *Wipe protection*.

The time that wipe protection is active counts down in the Hob display.

Deactivating wipe protection

- Touch  *Wipe protection* until the Hob display disappears.

Hob data



Displaying the model identifier/serial number

There must not be any cookware on the hob.

- Switch the hob off.
- Touch  *On/Off* for approx. 6 seconds. The seconds can be seen counting down in the Hob display.



The Hob display shows *P*.

The Cooking zone displays show the following:

-  and a number indicate the selected quick parameter.
- Depending on the model:
 -  and a number indicate the selected code of the selected quick parameter.

Other sensor controls light up.

The  *NFC icon* display lights up brightly.

- Touch + *Plus* or the Slider repeatedly until the Cooking zone displays at the back right shows the following: *903*
- Touch  *OK*.
- Touch + *Plus* repeatedly until the Cooking zone displays show the following: *£01*
- Touch  *OK*.

Numbers will appear in the Hob display one after another, separated by a dash.

Example: *12 34* (model identifier KM 1234) – *1 23 45 67 89* (serial number)

Displaying the software version

There must not be any cookware on the hob.

- Switch the hob off.
- Touch  *On/Off* for approx. 6 seconds. The seconds can be seen counting down in the Hob display.



The Hob display shows *P*.

The Cooking zone displays show the following:

- *9* and a number indicate the selected quick parameter.
- Depending on the model:
 - £* and a number indicate the selected code of the selected quick parameter.

Other sensor controls light up.

The  *NFC icon* display lights up brightly.

- Touch *+* *Plus* or the Slider repeatedly until the Cooking zone display at the back right shows the following: *902*
- Touch  *OK*.
- Touch *+* *Plus* repeatedly until the Cooking zone displays show the following: *£01*
- Touch  *OK*.

3 numbers appear in the Hob display:

Example: *1.23* = software version 1.23.

Activating/deactivating demo mode

There must not be any cookware on the hob.

- Switch the hob off.

- Touch  *On/Off* for approx. 6 seconds. The seconds can be seen counting down in the Hob display.



The Hob display shows *P*.

The Cooking zone displays show the following:

- *9* and a number indicate the selected quick parameter.
- Depending on the model:
 - £* and a number indicate the selected code of the selected quick parameter.

Other sensor controls light up.

The  *NFC icon* display lights up brightly.

- Touch Plus *+* or the Slider repeatedly until the Cooking zone display at the back right shows the following: *910*
- Touch  *OK*.
- Touch *+* *Plus* repeatedly until the Cooking zone display show the following: *£01*
- Touch  *OK*.
- Touch *+* *Plus* repeatedly until the Cooking zone display shows the following: *£01*
- Touch  *OK*.

The following will flash in the Hob display for a few seconds:

- *dE* alternating with *0n* (demo mode activated)
- or
- *dE* alternating with *0FF* (demo mode deactivated)

Setting ranges for the hob power levels

The hob is programmed with 9 power levels with intermediate levels at the factory. If you only want to use the whole-number settings for power levels, you can deactivate intermediate levels via the settings.

	Recommended cookware ¹	Setting range ²	
		Factory setting 9 levels with intermediate levels	Whole numbers 9 levels without intermediate levels
Melting butter	Pot	1.0–1.5	1–2
Melting chocolate			
Dissolving gelatine			
Keeping warm food which sticks easily		2.0–3.5	2–4
Heating small quantities of liquid			
Cooking rice	3.5–5.5	4–6	
Defrosting frozen vegetables in a block			
Making milk puddings			
Warming up liquid and semi-solid food	Frying pan	5.0–6.0	5–6
Steaming fruit			
Simmering potatoes	Frying pan with sandwich base and non-stick coating	4.5–6.5	5–7
Rendering bacon			
Making pancakes, omelettes, lightly fried eggs, etc.			
Steaming fish			
Steaming vegetables	See manufacturer's instructions	6.0–6.5	6
Cooking pasta and pulses			
Thickening sauces, e.g. Hollandaise	Frying pan	7.0–8.5	7–8
Defrosting and reheating frozen food			
Gentle frying (e.g. whole fish)			
Gentle frying (e.g. meat patties, chicken breast)	Pot with high rim	8.5–9.0	9
Frying (e.g. fish fillet, escalopes, fried eggs)			
Searing/hot frying (e.g. steak, small quantities of meat, fried potatoes, hash browns)	Pot with high rim or oven dish	Booster	Booster
Frying, e.g. chips			
Searing large quantities of meat	Pot	Booster	Booster

¹ Cook in covered pots and pans if possible. This prevents heat escaping unnecessarily.

² These settings should only be taken as a guide. The power of the induction coils will vary depending on the size and material of the cookware. For this reason, the power levels may need to be adjusted slightly to suit your cookware. As you use the hob, you will get to know which settings suit your cookware best. When using new cookware that you are not familiar with, set the power level to one level below the one specified.

Setting ranges for the hob power levels

Notes for test institutes

Test food acc. to EN 60350-2

Test food	Ø cookware base (mm)	Lid	Setting range	
			Pre-heating	Cooking
Heating oil up	150	No	–	1.0–1.5
Pancakes	180 (sandwich base)	No	9.0	5.0–6.0
Frying frozen chips	180 (chip pan)	No	9.0	9.0
Keeping warm a lentil stew	150 (sandwich base)	Yes (when keeping warm)	7.0	Keeping warm

Good to know

How induction hobs work

An induction coil is located under each induction cooking zone. The coil creates a magnetic field that reacts directly with the base of the cookware and heats it up. The cooking zone itself is heated up indirectly by the heat given off by the cookware.

An induction cooking zone only works when cookware with a magnetic base is placed on it. The hob automatically detects the size of the cookware.

Noises

When using induction cooking zones, the following noises can occur in the cookware, depending on what it is made of and how it has been constructed:

Buzzing on the higher power levels. This will decrease or cease altogether when the power level is reduced.

If the cookware base is made of layers of different materials (e.g. in a sandwiched base), it might emit a crackling sound.

Whistling might occur if linked cooking zones are being used at the same time and the cookware also has a base made of layers of different materials (e.g. sandwich base).

You might hear a clicking sound from the electronic switches, especially at lower power levels.

A whirring sound, when the cooling fan comes on. This switches on to protect the electronic module when the hob is being used intensively. The cooling fan may continue to run after the hob has been switched off.

Cookware

Suitable cookware

- Stainless steel cookware with a magnetic base
- Enamelled steel cookware
- Cast iron

Please be aware that the properties of the cookware base can affect the evenness with which the food heats up (e.g. when making pancakes). The base of the cookware must be able to distribute the heat evenly. Cookware with a base made from multilayer material (sandwich or encapsulated base) is ideal in this case.

Unsuitable cookware

- Stainless steel cookware without a magnetic base
- Aluminium or copper cookware
- Glass, ceramic or earthenware cookware

Testing cookware

To test whether a pot or pan is induction-compatible, hold a magnet to the base. If the magnet sticks, the pan is generally suitable.

Cookware tips

- Position the cookware as centrally as possible on the relevant cooking zone/cooking area.
- To make optimum use of the cooking zones, choose cookware with a suitable base diameter. If a pan is too small, it will not be detected.
- Use only pots and pans with smooth bases. Rough bases can scratch the ceramic surface.

- When cooking zones are joined together, we recommend using cookware which more or less covers the entire cooking area (e.g. an oven dish).
- Always lift cookware to move it. This will help prevent scratching. If any scratches do appear as a result of cookware being pushed around, this will not affect the function of the hob. These scratches are normal signs of use and are not grounds for making a complaint.
- Please note that the cookware diameter quoted by manufacturers often refers to the maximum diameter or diameter of the top rim. The diameter of the base (generally smaller) is more important.



- Where possible, use cookware with vertically straight sides. If an item of cookware has angular sides, induction also acts on the sides of the item of cookware. The sides of the item of cookware may discolour or the coating may peel off.

Adjusting settings

Accessing the Settings menu

There must not be any cookware on the hob.

- Switch the hob off.
- Touch **⓪** *On/Off* for approx. 6 seconds. The seconds can be seen counting down in the Hob display.

The Hob display shows *P*.

The Cooking zone displays show the following:

- **¶** and a number indicate the selected quick parameter.
- Depending on the model:
 - ↳ **⓪** and a number indicate the selected code of the selected quick parameter.

Other sensor controls light up.

The **(NFC)** *NFC icon* display lights up brightly.

- Touch **||▶** *Stop&Go*.

The Hob display shows *P⓪*.

The Cooking zone displays show the following:

- *P* and a number indicate the selected parameter.
- **⓪** and a number indicate the selected code of the selected parameter.

Setting parameters

The Settings menu has been accessed.

- Touch **+** *Plus* or *Slider* repeatedly until the required parameter number is displayed in the Cooking zone display.

In the Cooking zone display at the front left, the **⓪** lights up brightly. In the Cooking zone display at the front right, the currently set code number is displayed.

Setting parameters

The Settings menu has been accessed.

- Touch **+** *Plus* or *Slider* repeatedly until the required parameter number is displayed in the Cooking zone display.
- Touch **✓** *OK*.

In the Cooking zone display at the front right, the **⓪** and the currently set code number light up brightly.

Setting the code

A parameter must have been set.

- Touch **+** *Plus* repeatedly until the required code number is displayed in the Cooking zone display.
- Touch **✓** *OK*.

The setting is saved. You can now exit the settings or adjust further settings.

Closing the Settings menu

Unsaved changes are not applied.

- Touch **⓪** *On/Off*.

Adjusting settings

Parameter ¹		Code	Settings ²
P01	WiFi registration	C00	Not active/deactivated
		C01	Active but not configured
		C02	Active and configured (cannot be selected; displays whether connection was successful)
		C03	Start connection via Bluetooth
		C04	WiFi reset to default (C01)
		C05	Restart wireless module
P03	Hob power level setting range	C00	9 power levels with intermediate levels + Booster
		C01	9 power levels without intermediate levels + Booster
P04	Keypad tone when a sensor control is touched	C00	Off ³
		C01	Quiet
		C02	Medium
		C03	Loud
P05	Buzzer for timer functions	C00	Off
		C01	Quiet
		C02	Medium
		C03	Loud
		C04	Extra loud
P06	Buzzer for messages and faults	C00	Off (only possible for messages)
		C01	Quiet (minimum volume for faults)
		C02	Medium
		C03	Loud
P07	Maximum operating time	C00	Safety setting 0
		C01	Safety setting 1
		C02	Safety setting 2
P08	System lock	C00	System lock can only be activated manually
		C01	System lock activated automatically

Adjusting settings

Parameter ¹		Code	Settings ²
P09	Sensor control reaction speed	C00	Fast
		C01	Normal
		C02	Slow
P10	Reaction speed of Slider sensor control	C00	Fast
		C01	Normal
		C02	Slow
P11	Permanent pan recognition	C00	Permanent pan recognition off
		C01	Permanent pan recognition on
P12	Keeping warm temperature	C00	65–75 °C
		C01	50–55 °C
		C02	80–90 °C
P15	Contrast of sensor control lighting	C00	10 %
		C01	20 %
		C02	40 %
P16	Resetting settings	C00	Reset nothing
		C01	Reset all settings
		C02	Reset WiFi connection
P17	Factory default settings	C00	Do not restore factory default settings
		C01	Restore factory default settings
P21	Power management ⁴	C00	Off
		C01	1000 W
		C02	2000 W
		C03	3000 W
		C04	3680 W
		C05	4000 W
		C06	4500 W
		C07	5000 W
		C08	6000 W
		C09	7000 W

Adjusting settings

Parameter ¹		Code	Settings ²
P52	Demo mode	C00	Demo mode off
		C01	Demo mode on ⁵

- ¹ Parameters not shown here have no allocation.
- ² The factory default settings are printed in bold.
- ³ The keypad tone of ⓪ On/Off is not switched off.
- ⁴ The total hob power may be reduced in order to meet the local power supply provider's requirements.
Codes with values above the rated load of the hob are not displayed.
- ⁵ After the hob has been switched on, dE appears alternately with On in the Hob display for a few seconds.

Adjusting settings



Displaying the model identifier/ serial number

There must not be any cookware on the hob.

- Switch the hob off.
- Touch  *On/Off* for approx. 6 seconds. The seconds can be seen counting down in the Hob display.



The Hob display shows *P*.

The Cooking zone displays show the following:

-  and a number indicate the selected quick parameter.
- Depending on the model:
 -  and a number indicate the selected code of the selected quick parameter.

Other sensor controls light up.

The  *NFC icon* display lights up brightly.

- Touch *+* *Plus* or the Slider repeatedly until the Cooking zone displays at the back right shows the following: *903*
- Touch  *OK*.
- Touch *+* *Plus* repeatedly until the Cooking zone displays show the following: *£01*
- Touch  *OK*.

Numbers will appear in the Hob display one after another, separated by a dash.

Example: *12 34* (model identifier KM 1234) – *1 23 45 67 89* (serial number)



Displaying the software version

There must not be any cookware on the hob.

- Switch the hob off.
- Touch  *On/Off* for approx. 6 seconds. The seconds can be seen counting down in the Hob display.



The Hob display shows *P*.

The Cooking zone displays show the following:

-  and a number indicate the selected quick parameter.
- Depending on the model:
 -  and a number indicate the selected code of the selected quick parameter.

Other sensor controls light up.

The  *NFC icon* display lights up brightly.

- Touch *+* *Plus* or the Slider repeatedly until the Cooking zone display at the back right shows the following: *902*
- Touch  *OK*.
- Touch *+* *Plus* repeatedly until the Cooking zone displays show the following: *£01*
- Touch  *OK*.

3 numbers appear in the Hob display:

Example: *1.23* = software version 1.23.

Software update

Carrying out a software update

Information about the content and scope of an update is provided in the Miele app.

1. Your hob is networked with your home network
2. The Hob display shows *UP*.

■ Touch + *Plus*.

The Hob display shows *UP* and shortly afterwards *L* ... *E* ... *E* ...

When the hob switches off, the update is complete. You can use your hob as usual again.

Postponing the software update

Information about the content and scope of an update is provided in the Miele app.

However, Miele recommends installing the updates as soon as possible.

1. Your hob is networked with your home network
2. The Hob display shows *UP*.

■ Touch – *Minus*.

You can use your hob as usual.

If you restart your hob and no residual heat indicators light up, you will be prompted to perform the update again.

Switching off the software update

However, Miele recommends installing updates.

- To deactivate updates permanently, go to the Miele app or contact Miele Customer Service.

Cleaning and care

Safety notes on cleaning and care

 Risk of burning due to hot surfaces.

All parts of the hob may be hot after use.

Switch the hob off.

Allow the hob to cool down before cleaning it.

All surfaces could be discoloured or damaged if unsuitable cleaning agents are used or if residues from suitable cleaning agents are heated on the hob. All surfaces are susceptible to scratching.

Allow the surfaces to cool down before cleaning the hob.

Remove all cleaning agent residues immediately.

Never use abrasive sponges or cleaning agents.

Using washing-up liquid will not remove all soiling and residues. An invisible film can develop that can lead to discolouration of the ceramic glass surface. This discolouration cannot be removed.

Clean the glass ceramic surface regularly with a proprietary ceramic glass cleaner.

▶ Do not use a steam cleaner to clean the hob.

▶ Do not use pointed objects for cleaning.

When to clean

- Before each use:
Clean the entire hob and the base of the cookware.
- After every use:
Clean the entire hob.
- Once a week:
To prevent cleaning agent residue being burned on, clean the ceramic surface with the Miele ceramic and stainless steel cleaner or with a proprietary ceramic glass cleaner. Please follow the cleaning agent manufacturer's instructions.

Cleaning the ceramic glass surfaces

Removing light soiling

- Clean the entire ceramic surface of the hob with a damp, soft cloth and a solution of water and a little washing-up liquid. Please follow the cleaning agent manufacturer's instructions.

Removing stubborn soiling

- Remove any coarse soiling with a damp cleaning cloth and more stubborn soiling with a glass scraper.
- Clean the ceramic surface with the Miele ceramic and stainless steel cleaner or with a proprietary ceramic glass cleaner. Please follow the cleaning agent manufacturer's instructions.

Finishing the cleaning process

- Remove all cleaning agent residues with a damp cleaning cloth.
- Dry the ceramic surface of the hob after cleaning.

Unsuitable cleaning agents

To avoid damaging the surfaces of the appliance, do not use:

- Cleaning agents containing soda, alkalines, ammonia, acids or chlorides
- Stain and rust removers
- Abrasive cleaning agents, e.g. powder cleaners and cream cleaners
- Cleaning agents containing solvents
- Dishwasher cleaning agents
- Grill and oven sprays
- Hard, abrasive brushes
- Eraser stain remover blocks
- Sponges

Troubleshooting

Many malfunctions and faults can be easily remedied. You can save time and money in many cases, as you do not need to contact Customer Service.

More information to help you remedy faults yourself can be found at www.miele.de/support/customer-assistance.



Messages in the display

Problem	Cause and remedy
U flashes in a Cooking zone display .	<p>No cookware is present on the cooking zone. Unsuitable cookware is present on the cooking zone. The diameter of the base of the cookware is too small. Suitable crockery has been removed from the cooking zone.</p> <p>If no cookware or unsuitable cookware is placed on the cooking zone, the cooking zone will switch off automatically after 3 minutes.</p> <ul style="list-style-type: none"> ■ Place a suitable item of cookware on the cooking zone within 3 minutes. <p>U goes out. The cooking process starts/continues with the previously selected settings.</p> <ul style="list-style-type: none"> ■ If you are using a different item of cookware and/or food, adjust the settings.
After the hob has been switched on, or after touching a sensor control, LDC appears alternately with On in the Hob display for a few seconds.	<p>The system lock is activated.</p> <ul style="list-style-type: none"> ■ Deactivate the system lock.
	<p>The keypad lock is activated.</p> <ul style="list-style-type: none"> ■ Deactivate the keypad lock.
After the hob has been switched on, dE briefly appears alternately with On in the Hob display. The cooking zones do not heat up.	<p>The hob is in demo mode.</p> <ul style="list-style-type: none"> ■ Deactivate demo mode.
L flashes in the Hob display and the hob switches off automatically.	<p>One or more of the sensor controls are covered, e.g. by finger contact, food boiling over or an object.</p> <ul style="list-style-type: none"> ■ Remove the soiling or obstruction.

Problem	Cause and remedy
The Hob display shows UP	A software update is available for your hob. Touch — <i>Minus</i> to postpone the update. Perform the update at the next possible time or switch off the updates permanently.
Err flashes alternately with 044 in the Hob display.	The overheating protection mechanism has been activated. <ul style="list-style-type: none"> ■ Allow the hob to cool down. ■ Rectify the causes of the overheating. ■ Check that the hob is working. ■ If this fault message continues to appear in the display, contact the Customer Service Department.
Err flashes alternately with 710, 711, 712 or 713 in the Hob display.	The hob is incorrectly connected. <ul style="list-style-type: none"> ■ Disconnect the hob from the mains power supply. ■ Contact the Customer Service Department. The hob must be connected to the mains according to the wiring diagram.
Err alternately with 725, 727, 728 or 729 in the Hob display.	The fan is blocked or defective. <ul style="list-style-type: none"> ■ Make sure it has not been blocked by an object. ■ Remove the obstruction. ■ If this fault message continues to appear in the Hob display, contact Customer Service.
A message not listed in this table is appearing on the Hob display.	There is an electronic module fault. <ul style="list-style-type: none"> ■ Disconnect the power supply to the hob for approx. 1 minute. ■ If the problem persists after the power supply has been restored, please contact the Customer Service Department.

Unexpected behaviour

Problem	Cause and remedy
Power level 9 is automatically reduced if you also set power level 9 for the connected cooking zone.	Operating both zones at power level 9 exceeds the permitted maximum power for the two zones. <ul style="list-style-type: none"> ■ Use a different cooking zone.

Troubleshooting

Problem	Cause and remedy
<p>A cooking zone or the whole hob switches off automatically.</p>	<p>It has been operated for too long.</p> <ul style="list-style-type: none"> ■ Switch the hob or cooking zone on again. <hr/> <p>The overheating protection mechanism has been activated.</p> <ul style="list-style-type: none"> ■ Allow the hob to cool down. ■ Rectify the causes of the overheating. ■ Check that the hob is working. ■ If the problem occurs again, contact the Customer Service Department.
<p>The cooking zone is not working in the usual way with the set power level.</p>	<p>The overheating protection mechanism has been activated.</p> <ul style="list-style-type: none"> ■ Allow the hob to cool down. ■ Rectify the causes of the overheating. ■ Check that the hob is working. ■ If the problem occurs again, contact the Customer Service Department.
<p>The Booster level has deactivated early automatically.</p>	<p>The overheating protection mechanism has been activated.</p> <ul style="list-style-type: none"> ■ Allow the hob to cool down. ■ Rectify the causes of the overheating. ■ Check that the hob is working. ■ If the problem occurs again, contact the Customer Service Department.

Unsatisfactory results

Problem	Cause and remedy
<p>The food in the cookware does not heat up when the auto heat-up is switched on.</p>	<p>Large quantities of food are being cooked.</p> <ul style="list-style-type: none"> ■ Start cooking at the highest power level and then switch back manually. <hr/> <p>The cookware is not conducting heat properly.</p> <ul style="list-style-type: none"> ■ Use different cookware that is able to better conduct heat.

General problems or technical faults

Problem	Cause and remedy
<p>The hob or cooking zones will not switch on.</p>	<p>There is no power to the hob.</p> <ul style="list-style-type: none"> ■ Check whether the circuit breaker has tripped. Contact a qualified electrician or the Miele Customer Service Department (for the minimum fuse rating, see data plate). <p>There may be a technical fault.</p> <ul style="list-style-type: none"> ■ Disconnect the hob from the electricity supply for approx. 1 minute. To do this: <ul style="list-style-type: none"> – Trip the relevant mains fuse or screw the fine-wire fuse out completely, or – Switch off at the residual current device. ■ If the hob will still not turn on after resetting the trip switch in the fuse box or the residual current device, contact a qualified electrician or the Miele Customer Service Department.
<p>A smell and vapours are given off when the new hob is being used.</p>	<p>The metal components have a protective coating. When the hob is used for the first time, this causes a smell and possibly also vapour. The material from which the induction coils are made also gives off an odour in the first few hours of operation. With each subsequent use, the odour is reduced until it disappears completely. The odour and any vapours given off do not indicate a faulty connection or appliance and they are not hazardous to health.</p>
<p>An operating noise can be heard after the hob has been switched off.</p>	<p>The cooling fan runs until the hob has cooled down and then switches off automatically.</p>
<p>Various problems with settings, e.g. problems with networking</p>	<p>Changes to settings can lead to conflicts with each other.</p> <p>Fluctuations in the WiFi signal can lead to conflicts.</p> <div style="border: 1px solid gray; padding: 5px; margin: 5px 0;"> <p>If you reset settings to factory defaults, existing settings will be deleted. Document existing settings to restore existing settings.</p> </div> <ul style="list-style-type: none"> ■ Reset the settings to the factory defaults. <p>You can reset all settings or just individual settings such as the WiFi settings.</p>

Customer Service

Information to help you rectify faults yourself and about Miele spare parts can be found at www.miele.com/service.

Contact in the event of a fault

In the event of a fault which you cannot remedy yourself, please contact your Miele dealer or Miele Customer Service.

You can book a Miele Customer Service call-out online at www.miele.com/service.

Contact information for Miele Customer Service can be found at the end of this document.

Please quote the model identifier and serial number of your appliance (SN) when contacting Miele Customer Service. This information can be found on the data plate.

Data plate

Stick the extra data plate supplied with the appliance here. Make sure that the model identifier matches the one specified on the back cover of this document.



Warranty

For information on the appliance warranty specific to your country please contact Miele. See back cover for address.

In the UK, your appliance warranty is valid for 2 years from the date of purchase. However, you must activate your cover by calling 0330 160 6640 or registering online at www.miele.co.uk.

Technical data

ISM band frequency	2,400 GHz – 2,4835 GHz
RFID/NFC frequency	13,56 Mhz
WiFi transmission power	≤ 100 mW
RFID/NFC transmission power	≤ 100 mW
BTLE transmission power	≤ 10 mW
Power rating in off mode	≤ 0,5 W
Power rating in networked standby	≤ 2 W
Time until automatic switch to off mode	10 Min.
Time until automatic switch to networked standby	10 Min.

Product data sheets

The following product data sheets apply to the models described in these operating and installation instructions.

Information for domestic electric hobs

In acc. with regulation (EU) No. 66/2014

MIELE	
Model name/identifier	KM 8484 FR, KM 8484 FL, KM 8486 FX
Type of hob	built-in
Number of cooking zones and/or areas	5
For circular cooking zones: diameter of useful surface area/cooking zone For non-circular cooking zones or areas: length and width of useful surface area per electric cooking zone or area	1. = Ø 100–160 mm 2. = Ø 120–190 mm 3. = Ø 140–240 mm 4. = 230 x 460 mm
Energy consumption per cooking zone or area calculated per kg (EC _{electric cooking})	1. = 174,9 Wh/kg 2. = 173,3 Wh/kg 3. = 172,6 Wh/kg 4. = 176,8 Wh/kg 5. = 171,6 Wh/kg
Energy consumption for the hob calculated per kg (EC _{electric hob})	173,8 Wh/kg
- Dual-circuit ring / front left / Induction	
- Dual-circuit ring / rear left / Induction	
- Dual-circuit ring / Centred / Induction	
- PowerFlex XL cooking area / right / Induction	

Technical data

EU Conformity declaration

Miele hereby declares that this ceramic induction hob complies with Directive 2014/53/EU.

The complete text of the EU declaration of conformity is available from one of the following internet addresses:

- Products, Download from www.miele.ie
- For service, information, operating instructions etc: go to <https://miele.co.uk/manuals> and enter the name of the product or the serial number

UK Conformity declaration

Miele hereby declares that this ceramic induction hob complies with UK Radio Equipment Regulations 2017, as amended.

The complete text of the UK declaration of conformity is available from one of the following internet addresses:

- Products, Download from www.miele.co.uk
- For service, information, operating instructions etc: go to <https://miele.co.uk/manuals> and enter the name of the product or the serial number

This **Statement of Compliance** confirms this Miele product fully complies with the **Product Security and Telecommunications Infrastructure (Security Requirements for Relevant Connectable Products) Regulations 2023**.

- 1) Household Appliance – Inductions hobs IC08-01W
- 2) Manufactured by: Miele & Cie KG,
Carl Miele Street 29, 33332 Gutersloh Germany
Imported by and contact point: Miele Company Ltd, Fairacres, Marcham Road, Abingdon, Oxon, OX14 ITW Great Britain
- 3) The defined support period at the time of first supply is 10 years
- 4) To report vulnerabilities and cybersecurity issues please contact: psirt@miele.com
- 5) Signature 
Name: **Paul Wright**
Company Position: **Head of Technical Management**
Date of signature: **19th March 2024**
Place of signature: **Abingdon, Oxfordshire**

United Kingdom

Miele Co. Ltd., Fairacres, Marcham Road, Abingdon, Oxon, OX14 1TW
Tel: 0330 160 6600, Internet: www.miele.co.uk, E-mail: info@miele.co.uk

Australia

Miele Australia Pty. Ltd.
ACN 005 635 398
ABN 96 005 635 398
Level 4, 141 Camberwell Road
Hawthorn East, VIC 3123
Tel: 1300 464 353
E-mail: info@miele.com.au
Internet: www.miele.com.au

China Mainland

Miele Electrical Appliances Co. Ltd.
No. 82, Shimenyi Road, JingAn District
Shanghai, China, P.R.C
Post Code: 200040
Phone: +86 21 6157 3500
Fax: +86 21 6157 3511
E-mail: info@miele.cn
Internet: www.miele.cn

Hong Kong, China

Miele (Hong Kong) Ltd.
41/F - 4101, Manhattan Place
23 Wang Tai Road
Kowloon Bay, Hong Kong
Tel: (852) 2610 1025
Fax: (852) 3579 1404
E-mail:
customerservices@miele.com.hk
Website: www.miele.hk

India

Miele India Pvt. Ltd.
1st Floor, Copia Corporate Suites,
Commercial Plot 9, Mathura Road,
Jasola, New Delhi - 110025
E-mail: customercare@miele.in
Website: www.miele.in

Ireland

Miele Ireland Ltd.
2024 Bianconi Avenue
Citywest Business Campus
Dublin 24
Tel: (01) 461 07 10
Fax: (01) 461 07 97
E-mail: info@miele.ie
Internet: www.miele.ie

Malaysia

Miele Sdn Bhd
Suite 12-2, Level 12
Menara Sapura Kencana
Petroleum
Solaris Dutamas No. 1
Jalan Dutamas 1
50480 Kuala Lumpur, Malaysia
Phone: +603-6209-0288
Fax: +603-6205-3768

New Zealand

Miele New Zealand Limited
IRD 98 463 631
8 College Hill
Freemans Bay, Auckland 1011
Tel: 0800 464 353
E-mail: customercare@miele.co.nz
Internet: www.miele.co.nz

Singapore

Miele Pte. Ltd.
29 Media Circle
#11-04 ALICE@Mediapolis
Singapore 138565
Tel: +65 6735 1191
Fax: +65 6735 1161
E-mail: info@miele.com.sg
Internet: www.miele.sg

South Africa

Miele (Pty) Ltd.
63 Peter Place, Bryanston 2194
P.O. Box 69434, Bryanston 2021
Tel: (011) 875 9000
Fax: (011) 875 9035
E-mail: info@miele.co.za
Internet: www.miele.co.za

Thailand

Miele Appliances Ltd.
BHIRAJ TOWER at EmQuartier
43rd Floor Unit 4301-4303
689 Sukhumvit Road
North Klongton Sub-District
Vadhana District
Bangkok 10110, Thailand

United Arab Emirates

Miele Appliances Ltd.
Showroom 1, Eiffel 1 Building
Sheikh Zayed Road, Umm Al Sheif
P.O. Box 114782 - Dubai
Tel. +971 4 3044 999
Fax. +971 4 3418 852
800-MIELE (64353)
E-mail: info@miele.ae
Website: www.miele.ae

Manufacturer: Miele & Cie. KG, Carl-Miele-Straße 29, 33332 Gütersloh, Germany

KM 8484 FR, KM 8484 FL, KM 8486 FX

en-GB

M.-Nr. 12 985 320 / 01 / 002