

KENWOOD

TYPE: FDP23

3/3. Instructions

3/3. Istruzioni

3/3. Instrucciones

3/3. Bedienungsanleitungen

3/3. Gebruiksaanwijzing

3/3. Instrukcja obsługi

3/3. Instruções

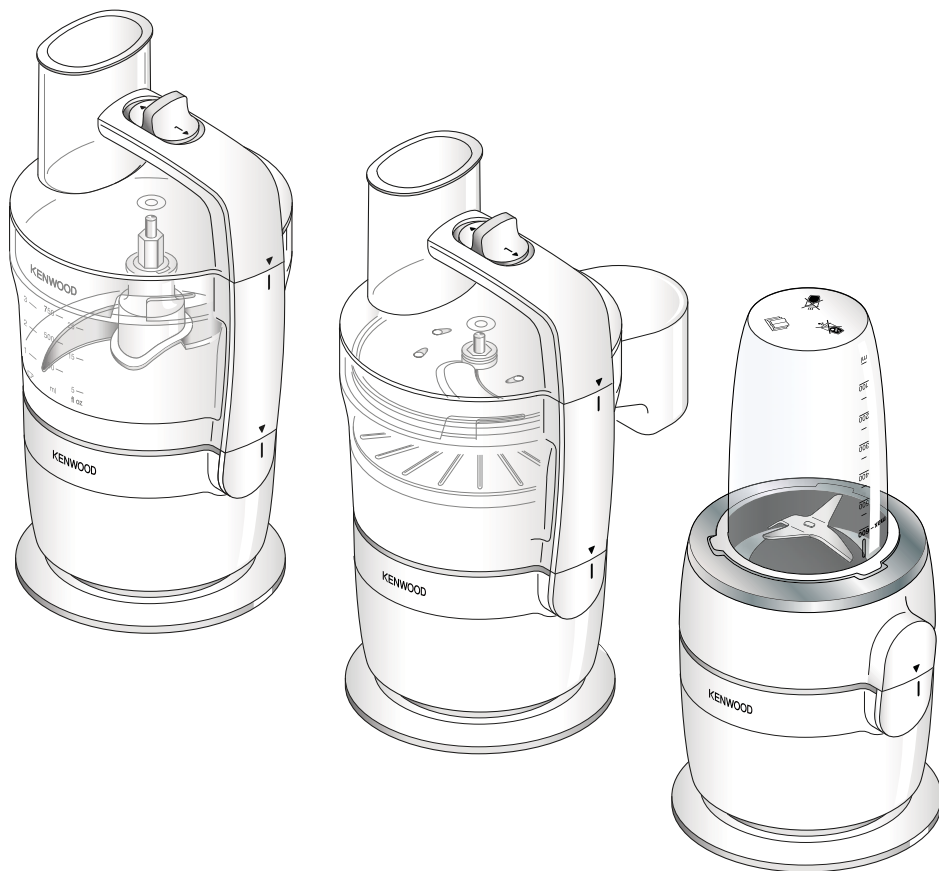

English	2 - 24
Nederlands	25 - 48
Français	49 - 72
Deutsch	73 - 96
Italiano	97 - 121
Português	122 - 145
Español	146 - 169
Català	170 - 193
Dansk	194 - 216
Svenska	217 - 239
Norsk	240 - 263
Suomi	264 - 286
Türkçe	287 - 310

English

- Important Safety Information 3-5
- Plug and Fuse Information 5
- Care and Cleaning 6-7
- Parts List 8-9
- To Use Your Food Processor – Knife Blade 10-12
 - Usage Diagrams and Usage Instructions 10-11
 - Usage Chart 11
 - Recipe 12
- To Use Your Food Processor – Discs 12-13
 - Usage Diagrams and Usage Instructions 12-13
 - Usage Chart 13
- To Use Your Express Serve 14-15
 - Usage Diagrams and Usage Instructions 14
 - Usage Chart 15
- To Use Your Personal Blender/Chopper 16-20
 - Usage Diagrams and Usage Instructions 16-18
 - Usage Chart 19
 - Recipe 20
- Cord Adjustment 20
- Storage 21
- Service and Customer Care 22
- Troubleshooting Guide 23-24

Important Safety Information



- Read these instructions carefully and retain for future reference.
- Before using for the first time, remove all packaging, marketing literature and plastic blade covers. Wash the parts: see 'Care and Cleaning'.
- If the plug or cord is damaged it must, for safety reasons, be replaced by Kenwood or an authorised Kenwood repairer in order to avoid a hazard.
- **DO NOT touch the sharp blades.** The blades and discs are very sharp, handle with care. **Always hold by the finger grip at the top, away from the cutting edge, when handling the sharp cutting blades, emptying the bowl and during cleaning.**
- **The food processor bowl and express serve are not suitable for processing ice cubes.**
- Before lifting or carrying the appliance by the handle on the lid, always check that the bowl and lid are securely locked in place.
- **Do not** process hot ingredients in any of the provided containers, including the personal blender. Hot liquids may be ejected out of the appliance due to sudden steaming.
- **Never** leave the appliance unattended when it is operating.
- **Do not** move appliance whilst in operation.
- **Do not** exceed the maximum capacities stated in the recommended usage chart.
- **Do not operate your appliance for longer than 30 seconds when processing dough without a 5 minute rest period. Processing continuously for longer periods can damage your appliance.**
- **Always** remove the knife blade and discs before pouring contents from the food processor bowl.
- Keep hands and utensils out of the food processor bowl whilst connected to the power supply.
- If food needs to be pushed down in the food processor bowl, use a suitable utensil such as a spatula.
- **Never** use your fingers to push food down the feed tube. Always use the pusher supplied.
- **Always** switch off the appliance and disconnect from the supply if it is left unattended and before assembling, disassembling or cleaning.
- CAUTION: Before removing the lid from the bowl wait until the attachment/ blades have completely stopped.
- **Do not** use excessive force to push food down the feed tube - you could damage your appliance.
- **Do not** use the lid lock to operate the processor, always use the on/off speed control.
- **Do not** operate the processor with the both the knife blade and a disc fitted. Use only one attachment at a time.
- **This appliance will be damaged and may cause injury if the interlock mechanism is subjected to excessive force.**
- **Never** use an unauthorised attachment.
- **Never** use a damaged appliance. Get it checked or repaired: see 'Service and customer care'.

- **Never** let the power unit, cord or plug get wet.
- **Do not** let excess cord hang over the edge of a table or worktop or touch hot surfaces.
- Children should be supervised to ensure that they do not play with the appliance.
- This appliance shall not be used by children. Keep the appliance and its cord out of reach of children.
- Appliances can be used by persons with reduced physical, sensory or mental capabilities or lack of experience and knowledge if they have been given supervision or instruction concerning use of the appliance in a safe way and if they understand the hazards involved.
- Only use the appliance for its intended domestic use. Kenwood will not accept any liability if the appliance is subject to improper use, or failure to comply with these instructions.
- Misuse of your appliance can result in injury.

Express Serve

- Avoid contact with moving parts. Keep fingers out of the food outlet opening.
- **Do not** operate without the slinger plate fitted. **If the slinger plate is not fitted food will clog under the plate and not exit the food outlet, resulting in damage to your attachment.**
- If the food is not exiting the food outlet, switch off and check that food is not clogging under the disc and the slinger plate is fitted. Clear any trapped food before continuing to process.
- **Do not run the Express Serve attachment continuously for longer than 2 minutes. Leave to cool for 2 minutes in between each 2 minute operation.**

Personal Blender/Chopper Safety

-  **DO NOT** process hot ingredients.
-  **DO NOT** blend carbonated liquids.
- **SCALD RISK:** Hot ingredients must be allowed to cool to room temperature before placing in the cup or before blending.
- Ingrediënten niet langer dan 24 uur in de beker bewaren.
- **Always** take care when handling the blade assembly and avoid touching the cutting edge of the blades when cleaning.
- **Never** run the blender/chopper empty.
- Smoothie recipes - never blend frozen ingredients that have formed a solid mass during freezing, break it up before adding to the cup.
- Only use the cup with the blade assembly supplied.
- **Never** drink any hot liquids from the cup.
- When drinking through the lid, take care that the drink is smooth. Some experimentation may be necessary to achieve the desired result, particularly when processing firm or unripened foods as you may find that some ingredients remain unprocessed.
- **Do not** blend frozen ingredients without liquid (except ice cubes).
- **Never** blend frozen fruit or vegetable pieces that are larger than 3 cm x 3 cm cubes.
- **Never** blend dry ingredients (e.g. spices, nuts) or run the blender/chopper empty.

- **Never** fit the blade assembly to the power unit without the cup fitted.
- **Always** remove stones from dried fruit before chopping.

Power Consumption

- When the appliance is not operating
 - Automatic switching to OFF Mode: Not applicable.
 - Off Mode Power: $\leq 0.3\text{W}$.



Plug and Fuse Information

- Make sure your electricity supply is the same as the one shown on the underside of the power unit.
- This appliance conforms to EC Regulation 1935/2004 on materials and articles intended to come into contact with food.





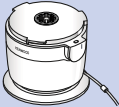



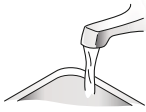

Before Using for the first time

- 1 Remove the plastic blade cover from the knife blade. Take care the blades are very sharp. This cover should be discarded as they are to protect the blade during manufacturer and transit only.
- 2 Wash the parts see 'care and cleaning'.

Care and Cleaning

			
	X	X	✓
	✓	✓	X
	✓	✓	X
	✓	✓	X
	✓	✓	X
	✓	✓	X
	✓	✓	X
	✓	✓	X
	✓	✓	X

Care and Cleaning

			
	X	X	✓
	✓	✓	X
	✓	✓	X
	✓	✓	X
	✓	✓	X
	✓	✓	X
	✓	✓	X

- Switch off, and wait for the attachment/blades to stop and unplug before cleaning.
- Wipe the power unit with a damp cloth, then dry. Ensure that the interlock area is clear of food debris.
- Do not immerse the power unit in water.
- Handle the blades and cutting discs with care - they are extremely sharp.
- If washing the personal blender/chopper blades by hand, they should be brushed clean and rinsed under running water.

Parts List

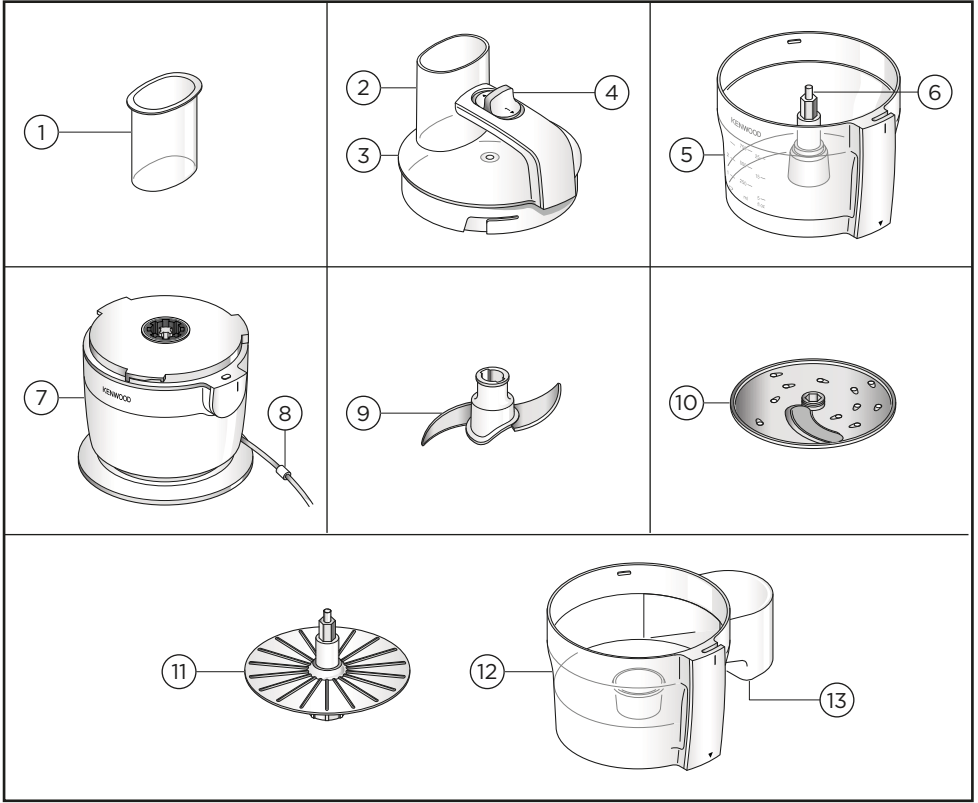

* If supplied

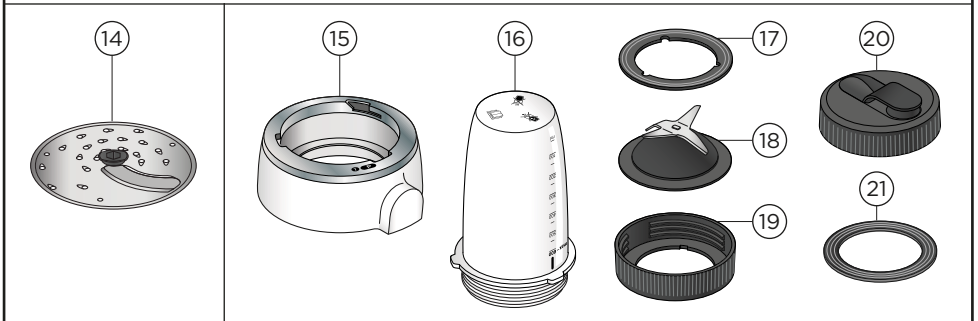

Key

Food Processor

- ① Pusher
- ② Feed tube
- ③ Lid
- ④ On/off switch + Pulse
- ⑤ Bowl
- ⑥ In Bowl drive
- ⑦ Power unit
- ⑧ Cord clip
- ⑨ Knife blade
- ⑩ 4mm Slicing/grating disc

Express Serve

- ⑪ Slinger plate
- ⑫ Express Serve Bowl
- ⑬ Food outlet

Disc

- ⑭ 2mm Slicing/grating disc (if supplied)

Personal Blender/Chopper

- ⑮ Personal Blender/Chopper Base
- ⑯ Cup
- ⑰ Sealing Ring
- ⑱ Blade Unit
- ⑲ Blade Holder
- ⑳ Drinking Lid
- ㉑ Drinking Lid Sealing Ring

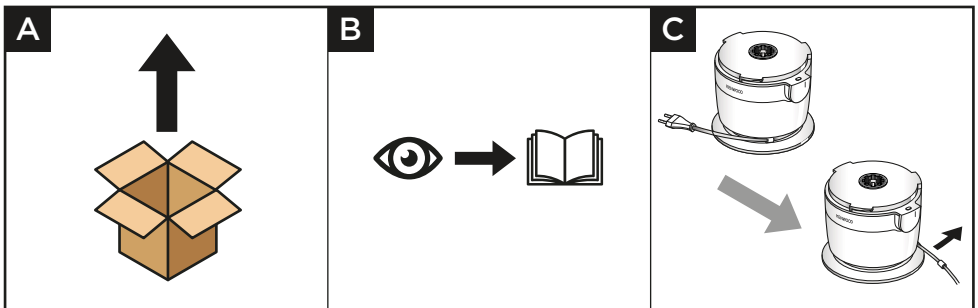

To Use Your Food Processor - Knife Blade

Usage Diagrams and Usage Instructions

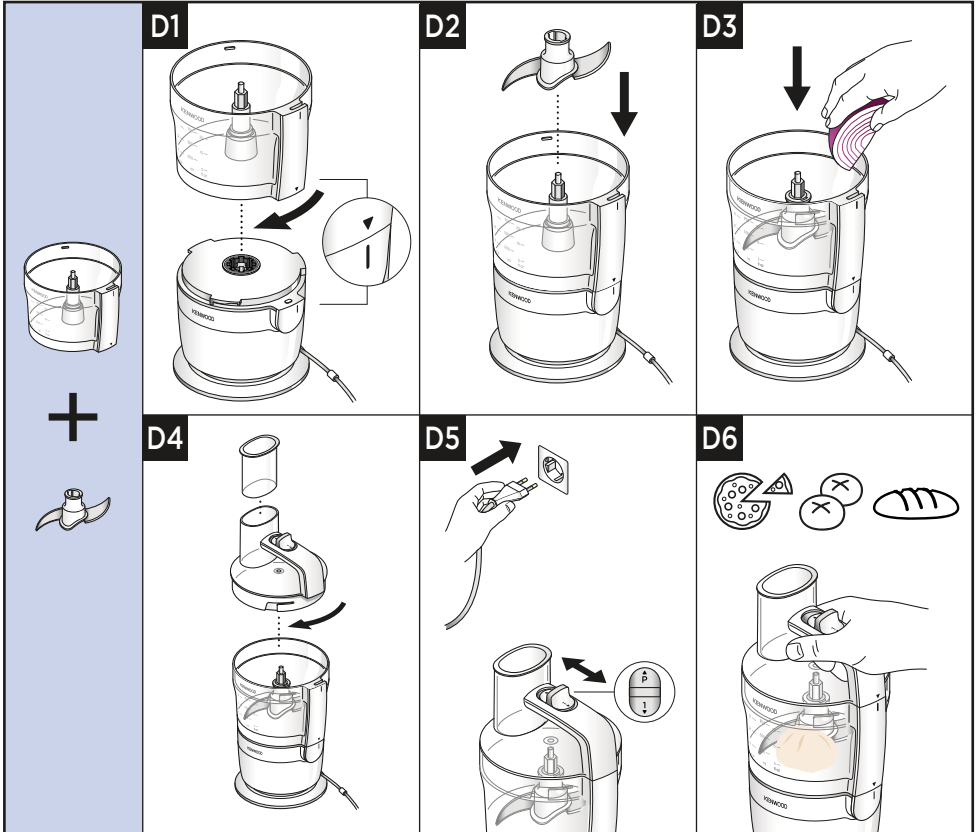

Important















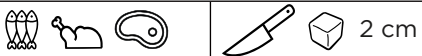
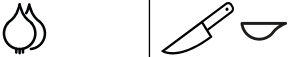
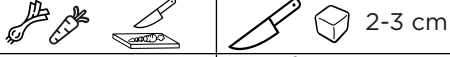
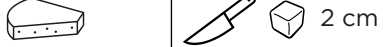

- Your processor is not suitable for crushing or grinding coffee beans and spices, converting granulated sugar to caster sugar or processing ice cubes.
- When adding almond essence or flavouring to mixtures avoid contact with the plastic as this may result in permanent marking.
- Always fit the bowl and attachment onto the processor before adding ingredients.
- Do not use the lid to operate the processor.
- The processor will not operate if the bowl or lid are not fitted correctly into the interlock. Check that the feed tube and bowl handle are situated to the right front hand corner.
- Always switch off and unplug before removing the lid.
- Bread dough, do not process for longer than 30 seconds.
- Re-knead bread dough by hand only. Re-kneading in the bowl is not recommended as it may cause the processor to become unstable.
- Always hold the unit by the handle when processing dough.

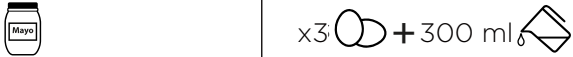
- 1 Fit the bowl onto the power unit, and turn clockwise to lock.
- 2 Fit the knife blade over the drive shaft.
- 3 Add ingredients to the food processor bowl.
- 4 Fit the lid.
- 5 Plug the unit into the mains power.
- 6 Switch the unit on or use the pulse function.

Hints and Tips

- Use the pulse (P) for short bursts. The pulse will operate for as long as the control is held in position.
- Some foods may discolour the plastic. This is perfectly normal and will not harm the plastic or affect the flavour of your food. Rub with a cloth dipped in vegetable oil to remove the discolouration.
- **Bread Dough** - Place the dry ingredients in the bowl first and then add the liquid. Process until a smooth elastic ball of dough is formed.
- Use the handle on the lid to support if the appliance starts to move on the worktop.
- For coarser textures use the pulse control.
- Take care not to over-process.
- When making pastry use fat straight from the fridge cut into 2cm cubes.

Usage Chart

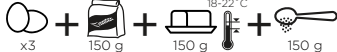
E		 MAX (g)	 (secs)
		20-30	10-20
		200	30
		150	20-30
		300	10/P
		200	P
		250	15-20
		100-200	20
		400	60
		x3  + 300 ml 	45-60
		250 g  + 150 g 	30
		250 g 	10-30
			20

Recipe

Prune Marinade

400 g Honey

40 g Prunes

50 ml Water

- 1 Storage ingredients in fridge overnight.
- 2 Process for 4 seconds on Pulse.

To Use Your Food Processor - Discs

Usage Diagrams and Usage Instructions

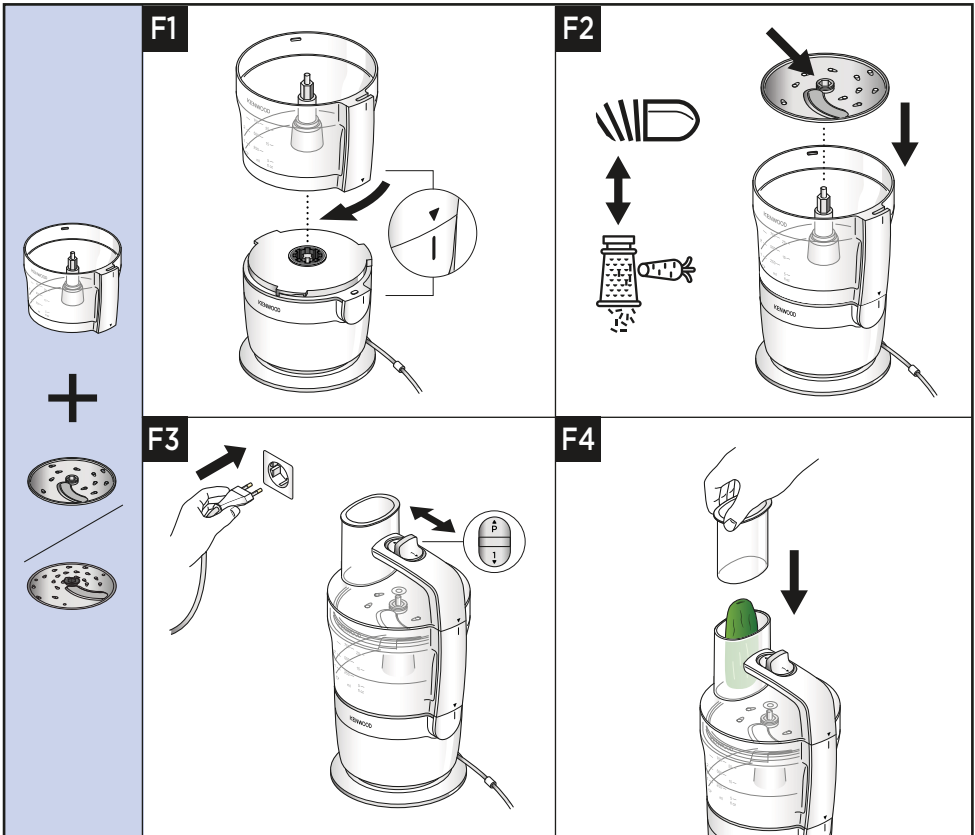

Important













- Never put your fingers in the feed tube.

- 1 Fit the bowl onto the power unit, and turn clockwise to lock.
- 2 Holding by the centre grip, place the disc onto the drive shaft with the appropriate side uppermost.
- 3 Fit the lid.
- 4 Put the food into the feed tube.
- 5 Plug in, switch to speed 1, and push down evenly with the pusher.

Hints and Tips

- Use fresh ingredients.
- Do not cut food too small. Fill the width of the feed tube with your ingredients (avoiding a tight fit), this prevents the food from slipping sideways during processing.
- When slicing or grating; food placed upright comes out shorter than food placed horizontally.
- There will always be a small amount of waste on the disc or in the bowl after processing.

Usage Chart

G 	 MAX (g)	 (secs)
	750 ml 	10-20
	750 ml 	10-20
	 MAX (g)	 (secs)
	750 ml 	10-20

To Use Your Express Serve

Usage Diagrams and Usage Instructions

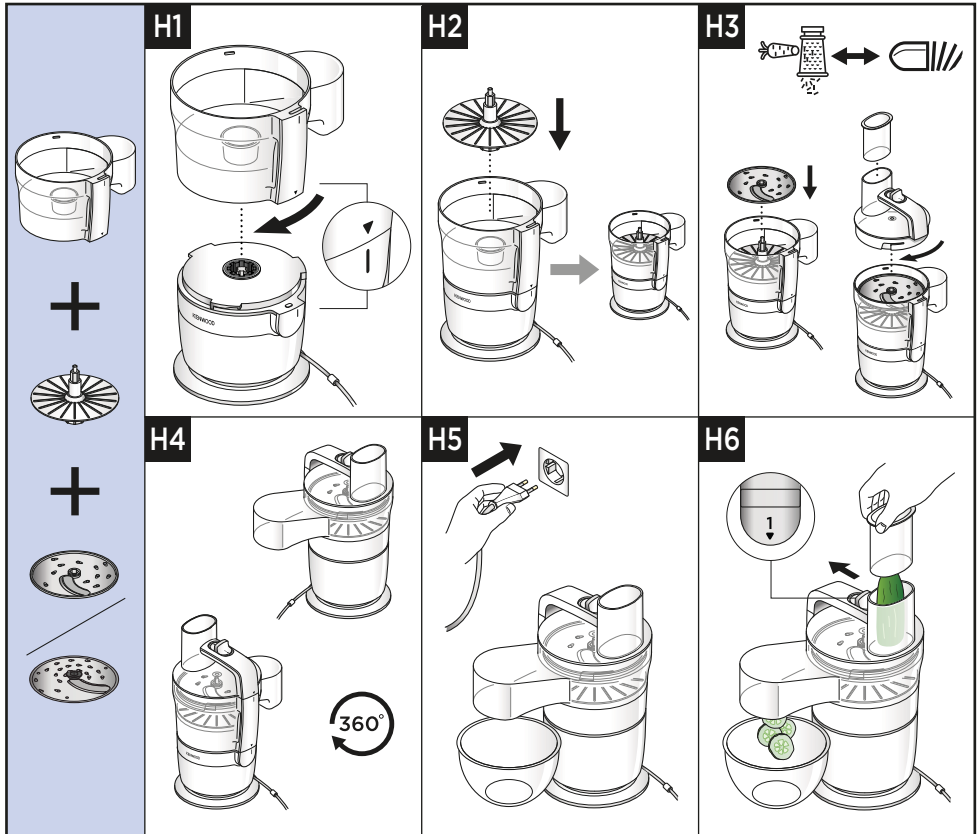











Important

- Do not apply excessive force when using the attachment.
- If food does not exit the food outlet, switch off and check that food is not clogging under the disc and the slinger plate is fitted. Clear any trapped food before continuing to process.

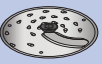
- 1 Fit the bowl onto the power unit, and turn clockwise to lock.
- 2 Fit the slinger plate and the required disc.
- 3 Fit the lid.
- 4 Put the food into the feed tube.
- 5 Plug in, switch to speed 1, and push down evenly with the pusher.

Usage Chart

I 	 MAX (g)	 (secs)
		120
		120
	 MAX (g)	 (secs)
		120

To Use Your Personal Blender/Chopper

Usage Diagrams and Usage Instructions

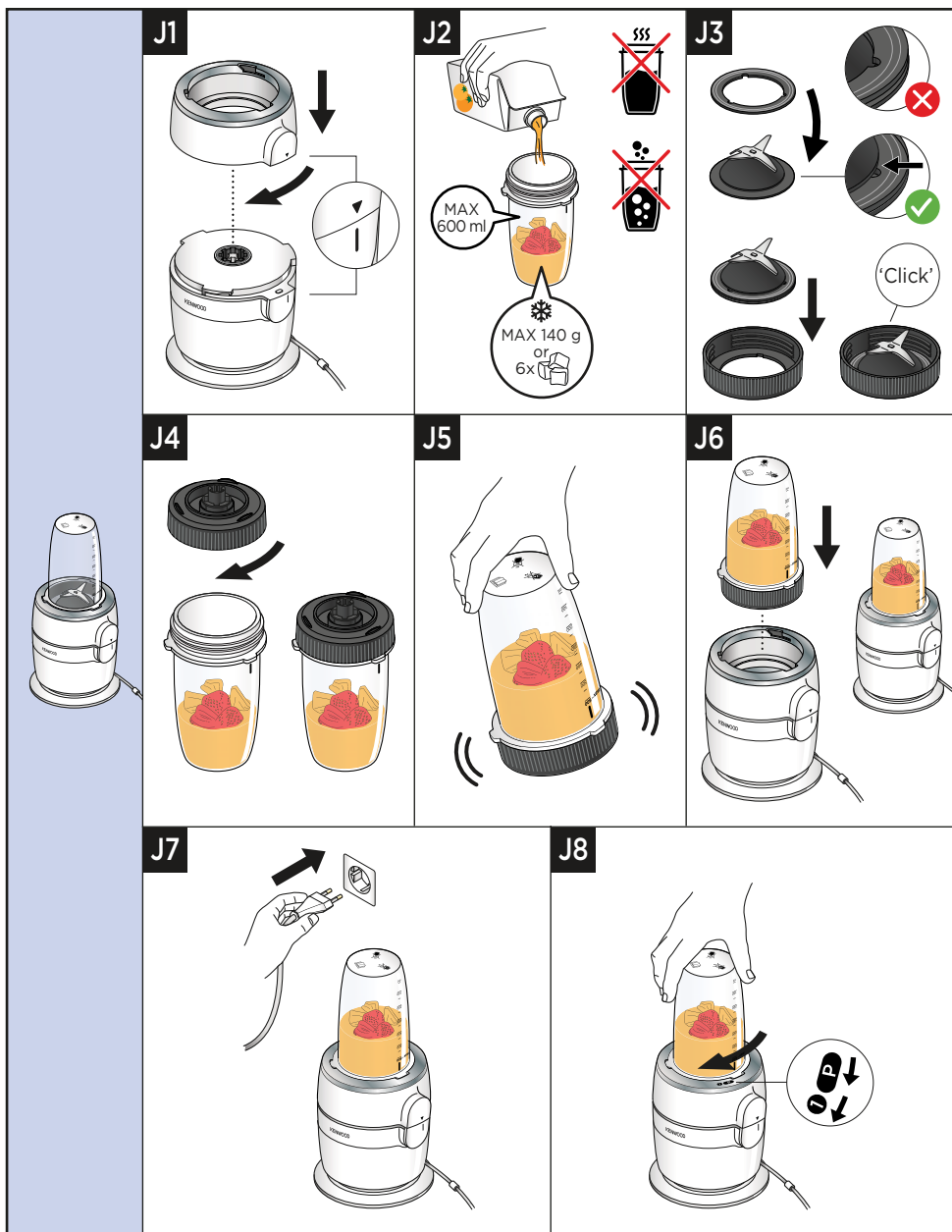

To Use Your Personal Blender/Chopper

Usage Diagrams and Usage Instructions

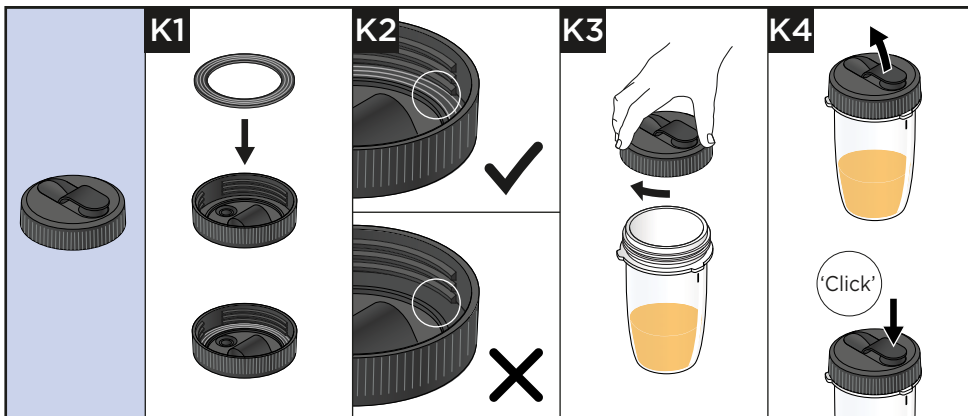

Important

- The personal blender/chopper base must be fitted to the power unit before fitting the personal blender/chopper.
- Do not blend frozen ingredients without liquid.
- Never blend frozen fruit or vegetable pieces that are larger than 3 cm x 3 cm cubes.
- Leaking will occur if the sealing ring is damaged or incorrectly fitted.
- Never blend frozen ingredients that have formed a solid mass.
- For best blending performance always add ice/frozen ingredients to the cup first.
- **Always** remove stones from dried fruit before chopping.

- 1 Fit the personal blender/chopper base onto the power unit, turn clockwise to lock.
- 2 Add ingredients to the cup, up to the 600ml level mark.
- 3 Fit the sealing ring to the blade unit, ensuring the seal is secured correctly in the grooved area.
- 4 Carefully lower the blade unit into the blade holder and clip into place to secure.
- 5 Hold the underside of the assembled blade holder and lower it onto the cup, blades down.
- 6 Screw the assembled blade holder onto the cup - turn clockwise to lock.
- 7 Shake to disperse the ingredients.
- 8 Lower the attachment onto the power unit.
- 9 Plug in. To select pulse speed, twist clockwise (towards P) and release the attachment, To select continuous speed twist the attachment clockwise (towards 1) until it locks into place.

Drinking Lid











- 10 Fit the sealing ring to the drinking lid, ensuring the seal is secured correctly in the grooved area.
- 11 To use the drinking lid, unscrew the assembled blade holder from the cup. Fit the drinking lid by turning clockwise.

- 12 When you want to drink, simply flip open the lid cover. The drink can be consumed straight from the cup.
- 13 After drinking, replace the lid cover. Press firmly to secure.

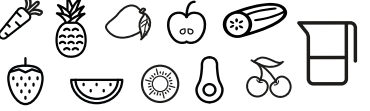
Hints and Tips

- Note that when the cup is filled to max capacity (600ml), this is approximately two servings.
- If you do not intend to consume your drink immediately, keep it refrigerated.
- Ensure your drink is thin enough to be able to drink from the dispensing lid. To make a thinner drink add more liquid.
- After blending, some drinks may not be completely smooth due to seeds or the fibrous nature of ingredients.
- Some drinks may separate on standing, therefore it is best to drink them straight away. Separated drinks should be stirred before drinking.
- When the drinking lid is fitted always keep the cup upright.

Usage Chart

L		 MAX (g)		 (secs)
	 3 cm	600 ml	1	30-60
		100 g	10-20	P
		X 6 120-140 g	P	10-20
		50 g	P	10-20
		100 g	1	30-60
		50 g	P	10

Recipe

Pesto

60g Fresh Basil
1 Garlic clove
25g Pine Nuts
25g Grated Parmesan
110g Olive Oil
Salt - to taste
Pepper - to taste

- 1 Place all ingredients into the blender/chopper cup. Pulse 5 times, followed by continuously processing until reaching the desired consistency (approximately 25 seconds).

Prune Marinade

300g Honey
40g Prunes
70ml Water

- 1 Place all ingredients in the blender/chopper cup. Store in the fridge overnight. (Do not store ingredients in the cup for longer than 24 hours).
- 2 Process for 4 seconds using Pulse speed. Use immediately.

Cord Adjustment

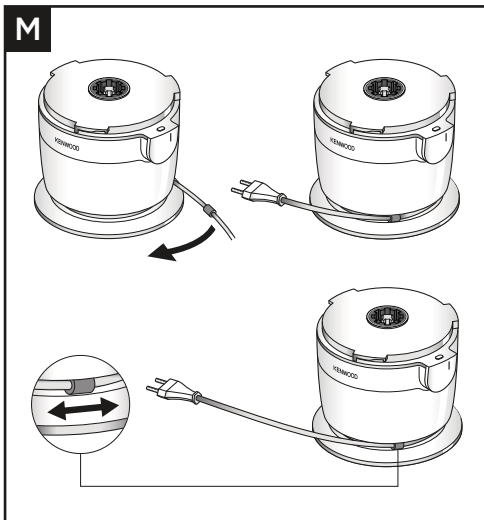

- Wrap the cord around the base of the processor to the desired length and clip the cord together using the cord clip.

Storage

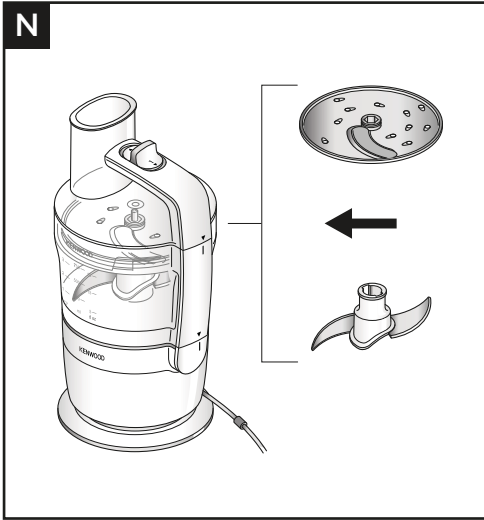

- After use, the knife blade and one disc can be stored together in the bowl.
- The second disc (if supplied) can be stored in the express serve bowl.
- Do not operate the processor, with both the knife blade and a disc fitted. Use only one attachment at a time.

Service and Customer Care

- If you experience any problems with the operation of your appliance, before requesting assistance refer to the 'Troubleshooting Guide' section in the manual or visit www.kenwoodworld.com.
- Please note that your product is covered by a warranty, which complies with all legal provisions concerning any existing warranty and consumer rights in the country where the product was purchased.
- If your Kenwood product malfunctions or you find any defects, please send it or bring it to an authorised KENWOOD Service Centre. To find up to date details of your nearest authorised KENWOOD Service centre visit www.kenwoodworld.com or the website specific to your Country.
- Designed and engineered by Kenwood in the UK.
- Made in China.



IMPORTANT INFORMATION FOR CORRECT DISPOSAL OF THE PRODUCT IN ACCORDANCE WITH THE EUROPEAN DIRECTIVE ON WASTE ELECTRICAL AND ELECTRONIC EQUIPMENT (WEEE)

At the end of its working life, the product must not be disposed of as urban waste. It must be taken to a special local authority differentiated waste collection centre or to a dealer providing this service.

Troubleshooting Guide

Problem	Cause	Solution
The processor will not operate.	No Power.	Check processor is plugged in.
	Bowl not fitted to power unit correctly.	The processor will not operate if the bowl or lid are not fitted correctly into the interlock.
	Bowl lid not locked on correctly.	Check that the bowl and lid are aligned and interlocked correctly.
Processor stops during processing.	Processor overloaded/ maximum capacities exceeded.	Check maximum capacities stated in the recommended usage chart.
	Lid unlocked.	Check lid is locked on correctly.
Can not fit the bowl to the base, with the lid fitted.	The On/off switch is in the 'On' position.	Move the switch to the 'off' position.
Food not exiting the outlet of the express serve.	The slinger plate is not fitted under the grating/ slicing disc.	Fit the slinger plate.
Slice or grated food damaged by the knife blade.	Operating with the knife blade and disc fitted in the bowl.	Remove the knife blade before using the grating/slicing disc.
Unit unstable/ heavy vibrations and movement.	Processing dough for too long.	Use the handle on the lid to support if the appliance starts to move on the worktop.
	Processor overloaded/ maximum capacities exceeded.	Do not process doughs for longer than 30 seconds and do not exceed maximum quantity recommended in the usage chart.
	Re-kneading dough.	Re-knead by hand only. Re-kneading in the bowl is not recommended as it may cause the processor to become unstable.
	Sticky fruit/ingredients such as dates being processed.	For best results use 'Pulse' first to break down the ingredients and then use continuous operation.
Heavy splashing or ingredients ejected from the feed tube.	Pusher not fitted.	Always fit the pusher when processing dough, pastry and cakes to prevent splashing from the feed tube .
Poor performance of the knife blade and disc.	Refer to the Hints and tip section and follow the recommendation in the usage chart.	

Troubleshooting Guide

Problem	Cause	Solution
Personal Blender/ Chopper will not operate.	Personal Blender/Chopper not locked on correctly Personal Blender/Chopper Base not locked on correctly	Personal Blender/Chopper will not operate if fitted incorrectly to the interlock.
Personal Blender/ Chopper leaking from blade assembly base.	Seal missing. Seal incorrectly fitted. Seal damaged. Blade holder not fully/ properly tightened.	Check the blade holder is fully screwed on. Check seal is fitted correctly into groove as per diagram J3 and not damaged. To obtain a replacement seal, see 'Service and Customer Care'
Personal Blender/ Chopper leaking from drinking lid.	Lid unlocked.	Check lid is locked on correctly.

Nederlands

- Belangrijke veiligheidsinformatie 26-28
- Voordat u de stekker in het stopcontact steekt 28
- Onderhoud en reiniging 29-30
- Onderdelenlijst 31-32
- Uw foodprocessor gebruiken – Meselement 33-36
 - Gebruiksdiagrammen en gebruiksaanwijzing 33-34
 - Tabel voor aanbevolen gebruik 35
 - Recepten 36
- Uw foodprocessor gebruiken – Schijven 36-37
 - Gebruiksdiagrammen en gebruiksaanwijzing 36-37
 - Tabel voor aanbevolen gebruik 37
- Uw Express Serve gebruiken 38-39
 - Gebruiksdiagrammen en gebruiksaanwijzing 38
 - Tabel voor aanbevolen gebruik 39
- Uw Personal Blender/hakhulpstuk gebruiken 40-44
 - Gebruiksdiagrammen en gebruiksaanwijzing 40-42
 - Tabel voor aanbevolen gebruik 43
 - Recepten 44
- Snoer afstellen 44
- Opslag 45
- Onderhoud en klantenservice 46
- Problemen oplossen 47-48

Belangrijke veiligheidsinformatie

- Lees deze instructies zorgvuldig door en bewaar ze voor toekomstig gebruik.
- Verwijder al het verpakkingsmateriaal, het marketingmateriaal en de plastic beschermhoezen van de messen alvorens dit product voor de eerste keer te gebruiken. Was de onderdelen: zie “Onderhoud en reiniging”.
- Als de stekker of het snoer beschadigd is, moet het om veiligheidsredenen door Kenwood of een door Kenwood geautoriseerd reparatiebedrijf vervangen worden, om gevaar te voorkomen.
- **Raak de scherpe mesjes niet aan.** De messen en schijven zijn erg scherp; ga er dus voorzichtig mee om. **Bij het hanteren van de scherpe snijbladen, het legen van de kom en tijdens schoonmaken altijd vasthouden aan de vingergreep aan de bovenkant, weg van de snijkant.**
- **De kom van de foodprocessor en Express Serve zijn niet geschikt voor het verwerken van ijsklontjes.**
- Controleer voordat u het apparaat aan het handvat van het deksel optilt of op die manier gaat dragen, dat de kom en het deksel goed op hun plaats zijn vastgezet.
- **Nooit** hete ingrediënten verwerken in de meegeleverde houders, inclusief de Personal Blender. Hete vloeistoffen kunnen vanwege plotseling stomen uit het apparaat spatten.
- Laat het apparaat **nooit** onbeheerd terwijl het aan staat.
- Het apparaat tijdens bedrijf **nooit** verplaatsen.
- **Nooit** de opgegeven maximumcapaciteit overschrijden: zie tabel voor aanbevolen gebruik.
- **Laat het apparaat wanneer u deeg verwerkt nooit langer dan 30 seconden draaien zonder een rustpauze van 5 minuten. Continu gebruik gedurende langere perioden kan het apparaat beschadigen.**
- Verwijder **altijd** het meselement en de schijven voordat u ingrediënten in de kom van de foodprocessor giet.
- Houd uw handen en keukengerei uit de kom van de foodprocessor wanneer de stekker van het apparaat in het stopcontact zit.
- Als ingrediënten in de kom van de foodprocessor moeten worden geduwd, gebruik dan geschikt keukengerei, zoals een spatel.
- Gebruik **nooit** uw vingers om voedsel in de toevoerbuis te duwen. Gebruik altijd de meegeleverde stamper.
- Schakel het apparaat **altijd** uit en khaal de stekker uit het stopcontact als het onbeheerd wordt achtergelaten en vóór montage, demontage of reiniging.
- LET OP: Wacht totdat het hulpstuk/de messen helemaal zijn gestopt alvorens het deksel van de kom te verwijderen.
- Gebruik **nooit** overmatige kracht om ingrediënten in de toevoerbuis te duwen. Dit kan het apparaat beschadigen.
- Gebruik **nooit** de dekselvergrendeling om de foodprocessor te bedienen; gebruik altijd de aan/uit-knop.
- Gebruik de foodprocessor **nooit** als zowel het mes als een schijf zijn aangebracht. Gebruik slechts één hulpstuk tegelijk.
- **Als teveel kracht wordt uitgeoefend op het vergrendelingsmechanisme, wordt dit apparaat beschadigd en kan het letsel veroorzaken.**
- Gebruik nooit een niet bij het apparaat behorend hulpstuk.

- Gebruik nooit een beschadigd apparaat. Laat het nakijken of repareren: zie 'Onderhoud en klantenservice'.
- Laat het motorblok, het netsnoer of de stekker **nooit** nat worden.
- Laat het snoer **nooit** over de rand van een tafel of werkblad hangen of in aanraking komen met hete oppervlakken.
- Op kinderen moet toezicht gehouden worden om er zeker van te zijn dat ze niet met het apparaat spelen.
- Dit apparaat mag niet door kinderen worden gebruikt. Houd het apparaat en het snoer buiten het bereik van kinderen.
- Dit apparaat kan worden gebruikt door personen met verminderde lichamelijke, sensorische of geestelijke capaciteiten of gebrek aan ervaring en kennis mits ze onder toezicht staan of instructies hebben gekregen over het veilige gebruik van het apparaat, en de betrokken risico's begrijpen.
- Gebruik het apparaat alleen voor het huishoudelijke gebruik waarvoor het is bedoeld. Kenwood kan niet aansprakelijk worden gesteld als het apparaat niet correct werd gebruikt, of deze instructies niet werden opgevolgd.
- Verkeerd gebruik van het apparaat kan letsel veroorzaken.

Express Serve

- Vermijd contact met bewegende delen. Houd vingers uit de buurt van de voedseluitlaatopening.
- Gebruik het apparaat niet zonder de slingerplaat. **Als de slingerplaat niet is aangebracht, kan er voedsel ophopen onder de plaat en de opening verstoppen wat vervolgens uw hulpstuk kan beschadigen.**
- Als er geen voedsel uit de uitlaatopening komt, zet het apparaat dan uit en controleer dat er geen voedsel is opgehoopt onder de schijf en dat de slingerplaat is aangebracht. Verwijder opgehoopt voedsel alvorens verder te gaan.
- **Gebruik het Express Serve hulpstuk nooit langer dan 2 minuten aan een stuk. Na elke 2 minuten moet u het apparaat telkens 2 minuten laten afkoelen.**

Veiligheid Personal Blender/hakhulpstuk

-  Verwerk **NOOIT** hete ingrediënten.
-  Verwerk **NOOIT** koolzuurhoudende vloeistoffen.
- **RISICO VAN BRANDWONDEN:** laat hete ingrediënten **altijd** tot kamertemperatuur afkoelen alvorens ze in de beker te doen en te mengen.
- Ingrediënten niet langer dan 24 uur in de beker bewaren.
- Wees **altijd** voorzichtig wanneer u de messen hanteert en raak het snijvlak van de messen bij het reinigen niet aan.
- Laat de blender of het hakhulpstuk **nooit** leeg draaien.
- Recepten voor smoothies – meng nooit diepgevroren ingrediënten die tot een dichte massa zijn bevroren, breek ze op alvorens ze in de beker te doen.
- Gebruik de beker **alleen** met het meegeleverde meselement.
- Drink **nooit** hete vloeistoffen uit de beker.
- Drink uitsluitend gladde dranken door het deksel. Voor het gewenste resultaat moet u misschien experimenteren, vooral als u stevig of onrijp voedsel gebruikt, omdat sommige ingrediënten in dat geval niet goed verwerkt worden.

- Meng **nooit** droge ingrediënten (bijv. specerijen, noten) en laat de blender of het hakhulpstuk nooit leeg draaien.
- Meng **nooit** bevroren stukjes fruit of groente die groter zijn dan 3 cm x 3 cm.
- Meng bevroren ingrediënten **nooit** zonder vloeistof (behalve ijsblokjes).
- Plaats het meselement nooit op het motorblok zonder dat de beker is geplaatst.
- Haal **altijd** de pitten uit gedroogd fruit alvorens dat te hakken.

Stroomverbruik

- Wanneer het apparaat niet werkt
 - Automatisch overschakelen naar de UIT-modus: niet van toepassing
 - Voeding in UIT-modus: $\leq 0,3$ W.

Voordat u de stekker in het stopcontact steekt

- Controleer of de elektriciteitsvoorziening dezelfde spanning heeft als op de onderkant van het apparaat wordt aangegeven.
- Dit apparaat voldoet aan EG Verordening 1935/2004 inzake materialen en voorwerpen die bestemd zijn om met levensmiddelen in contact te komen.











Vóór het eerste gebruik

- 1 Verwijder de plastic beschermhoes van het meselement. Wees voorzichtig, de messen zijn erg scherp. Deze hoes moet worden weggegooid, want die is alleen bedoeld om het meselement tijdens productie en transport te beschermen.
- 2 Was de onderdelen. Zie 'Onderhoud en reiniging'.

Onderhoud en reiniging

			
	X	X	✓
	✓	✓	X
	✓	✓	X
	✓	✓	X
	✓	✓	X
	✓	✓	X
	✓	✓	X
	✓	✓	X
	✓	✓	X

Onderhoud en reiniging

			
	X	X	✓
	✓	✓	X
	✓	✓	X
	✓	✓	X
	✓	✓	X
	✓	✓	X
	✓	✓	X

- Schakel het apparaat uit, wacht totdat het hulpstuk/meselement gestopt is en haal de stekker uit het stopcontact alvorens het apparaat schoon te maken.
- Veeg het motorblok af met een vochtige doek en droog dat vervolgens af. Zorg ervoor dat het interlockgebied vrij is van voedselresten.
- Dompel het motorblok niet in water onder.
- Wees voorzichtig met de messen en de schijven, ze zijn bijzonder scherp.
- Als u de Personal Blender of het hakhulpstuk met de hand wast, borstel ze dan schoon en spoel ze onder stromend water af.

Onderdelenlijst

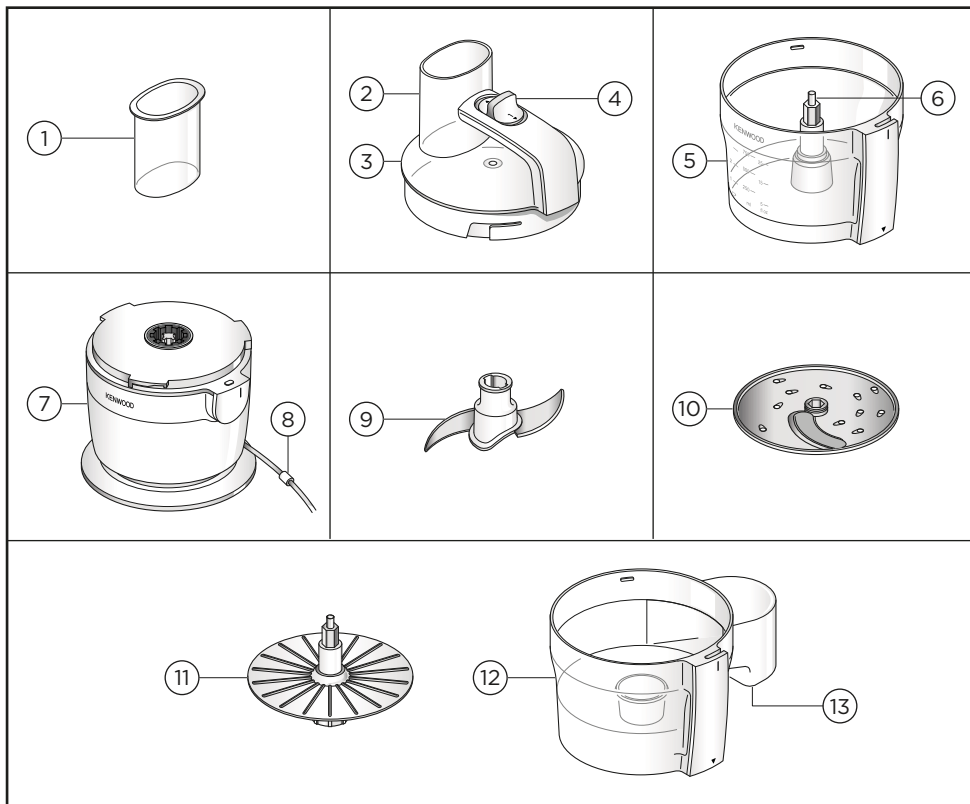

* Indien geleverd

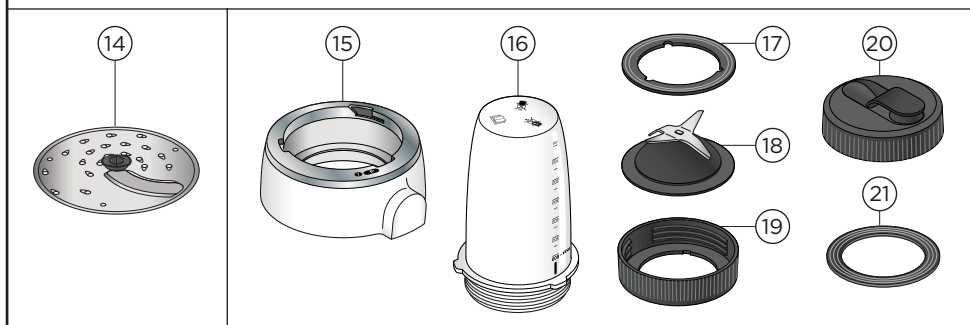

Legenda

Foodprocessor

- ① Stamper
- ② Toevoerbuis
- ③ Deksel
- ④ Aan/uit-knop + Pulsieren
- ⑤ Kom
- ⑥ Aandrijving in de kom
- ⑦ Motorblok
- ⑧ Snoerklem
- ⑨ Mes
- ⑩ Schijf voor snijden/raspen 4 mm

Express Serve

- ⑪ Slingerplaat
- ⑫ Express Serve kom
- ⑬ Voedseluitlaat

Schijf

- ⑭ Schijf voor snijden/raspen 2 mm (indien meegeleverd)

Personal Blender/hakhulpstuk

- ⑮ Voet Personal Blender/hakhulpstuk
- ⑯ Beker
- ⑰ Afdichtring
- ⑱ Meselement
- ⑲ Meshouder
- ⑳ Drinkdeksel
- ㉑ Afdichtring drinkdeksel

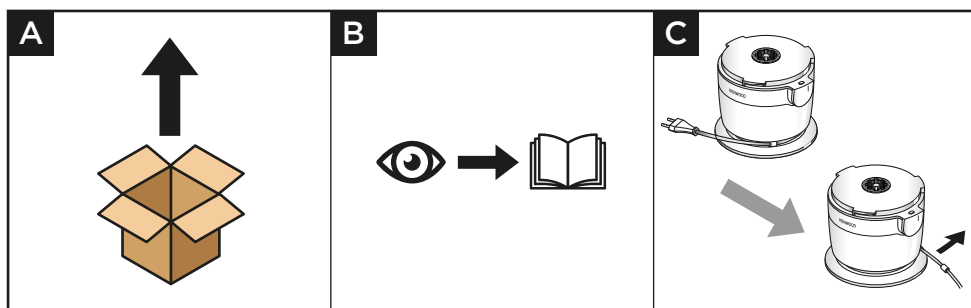

Uw foodprocessor gebruiken – Meselement

Gebruiksdiagrammen en gebruiksaanwijzing

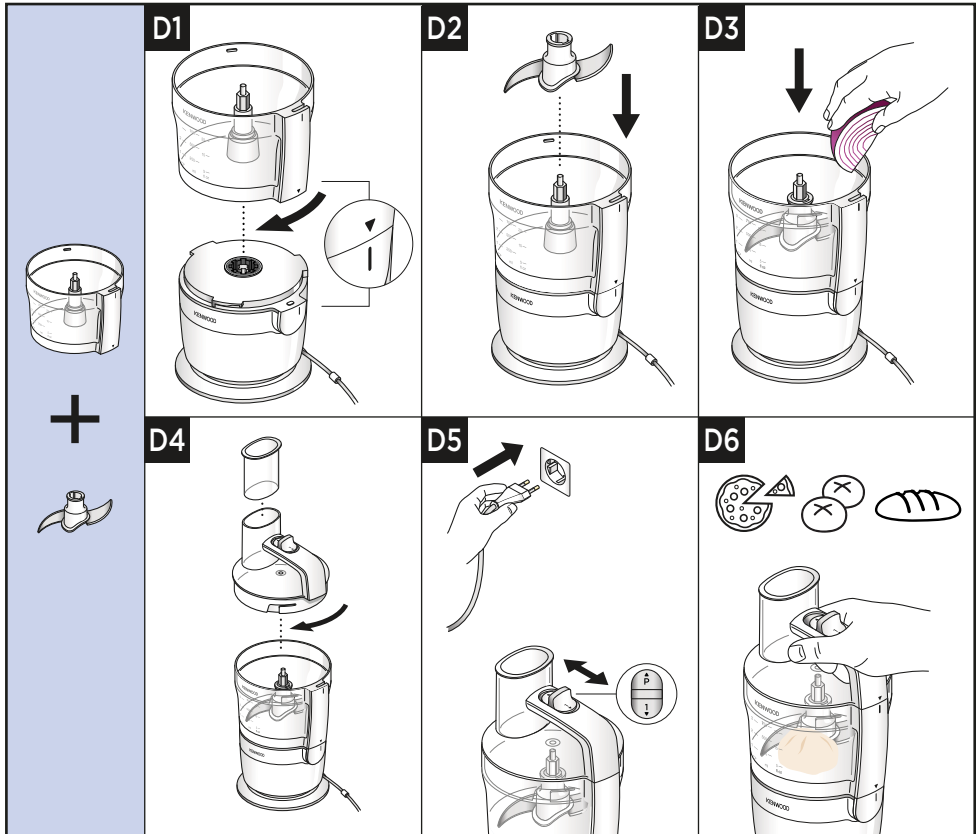

Belangrijk

































- De foodprocessor is niet geschikt voor het verpulveren of malen van koffiebonen en specerijen, om kristalsuiker tot poedersuiker te vermalen of om ijsblokjes te verwerken.
- Wanneer u amandelessence of -smaakstof aan mengsels toevoegt, dient u het contact met kunststof te vermijden, aangezien dit permanente vlekken kan geven.
- Zet de kom en het hulpstuk altijd op de foodprocessor voordat u ingrediënten toevoegt.
- Nooit het deksel gebruiken om de foodprocessor te bedienen.
- De machine functioneert niet als de kom of het deksel niet goed vergrendeld zijn. Controleer of de vultrechter en de komhendel zich rechtsvoor bevinden.
- Voordat u het deksel verwijdert, dient u het apparaat altijd uit te schakelen en de stekker uit het stopcontact te halen.
- Brooddeeg niet langer dan 30 seconden verwerken.
- Knead brooddeeg alleen met de hand opnieuw. Opnieuw kneden in de kom wordt afgeraden omdat de foodprocessor dan instabiel kan worden.
- Houd de eenheid altijd aan de handgreep vast wanneer u deeg verwerkt.

- 1 Zet de kom op het motorblok en draai hem rechtsom vast.
- 2 Zet het meselement op de aandrijfas.
- 3 Doe de ingrediënten in de kom van de foodprocessor.
- 4 Zet het deksel op zijn plaats.
- 5 Steek de stekker in het stopcontact.
- 6 Druk op de aan/uit-schakelaar of gebruik pulseren om het apparaat aan te zetten.

Tips

- Gebruik de pulsknop (P) voor korte impulsen. De impuls duurt zolang als de knop ingedrukt gehouden wordt.
- Sommige ingrediënten kunnen het plastic verkleuren. Dit is absoluut normaal; het tast het plastic niet aan en heeft geen invloed op de smaak van uw gerecht. Wrijf er met een in plantaardige olie gedoopte doek over om de verkleuring te verwijderen.
- **Brooddeeg** - Doe eerst de droge ingrediënten in de kom en voeg pas dan de vloeistof toe. Verwerk het totdat er een gladde, elastische deegbal is gevormd.
- Gebruik het handvat op het deksel als stabilisator als het apparaat op het werkblad begint te bewegen.
- Gebruik de pulsknop voor een grovere textuur.
- Zorg ervoor dat u de machine niet te lang gebruikt.
- Als u gebak maakt en de boter rechtstreeks uit de koelkast gebruikt, moet u de boter in blokjes van 2 cm snijden.

Tabel voor aanbevolen gebruik

E	 MAX (g)	 (sec.)
	20-30	10-20
	200	30
	150	20-30
	  2 cm	10/P
	  1/4	P
	  2-3 cm	15-20
	  2 cm	20
	400	60
	x3  + 300 ml 	45-60
	250 g  + 150 g 	30
	250 g 	10-30
	 x3 +  150 g +  150 g +  18-22°C +  150 g	20

Recepten

Pruimenmarinade

400 g honing

40 g pruimen

50 ml water

- 1 Laat dit een hele nacht in de koelkast staan.
- 2 Verwerk 4 seconden lang met de pulseerfunctie.

Uw foodprocessor gebruiken - Schijven

Gebruiksdiagrammen en gebruiksaanwijzing

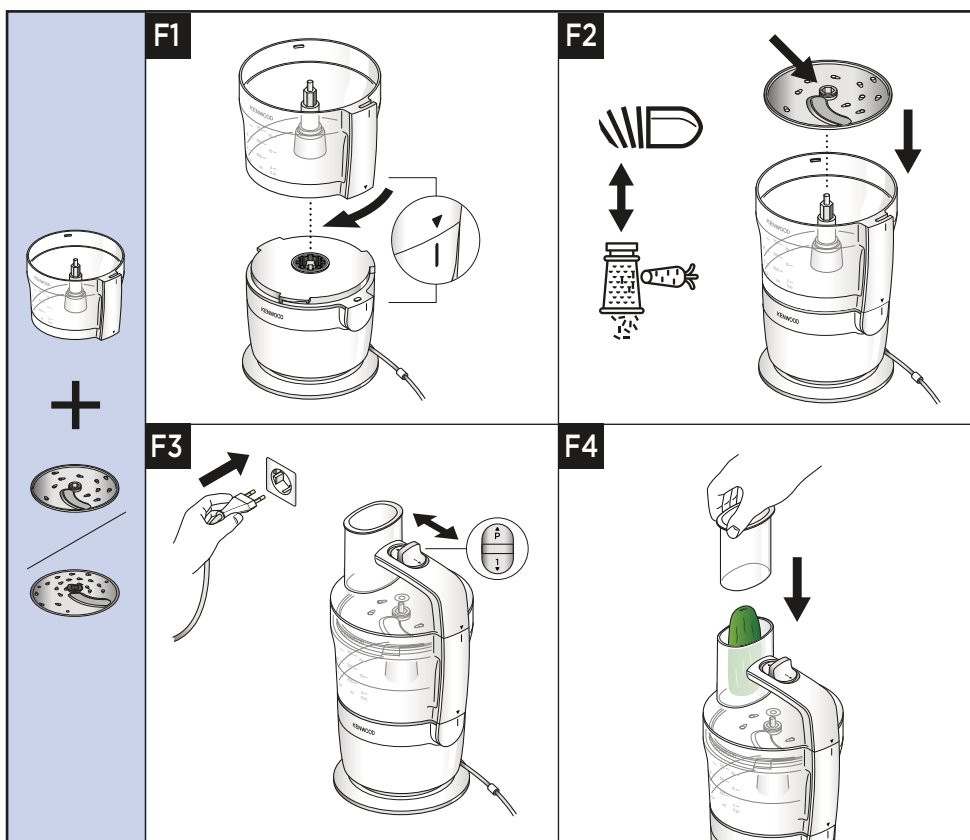

Belangrijk











- Steek uw vingers nooit in de vultrechter.

- 1 Zet de kom op het motorblok en draai hem rechtsom vast.
- 2 Houd de schijf aan de middengreep vast en plaats hem op de aandrijftras, met de juiste zijde naar boven gekeerd.
- 3 Zet het deksel op zijn plaats.
- 4 Doe de ingrediënten in de vulopening.
- 5 Steek de stekker in het stopcontact, selecteer snelheid 1 en duw de ingrediënten gelijkmatig met de stamper naar beneden.

Tips

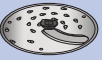
- Gebruik verse ingrediënten.
- Snij de ingrediënten niet in te kleine blokjes. Vul de hele breedte van de vulopening met ingrediënten (maar druk ze niet te vast aan). Dit voorkomt dat de ingrediënten tijdens het verwerken opzij glijden.
- Bij gebruik van de snij- of raspschijf: voedsel dat rechtop in de vultrechter wordt gezet, komt er korter uit dan voedsel dat horizontaal wordt ingebracht.
- Na de verwerking blijft er altijd een kleine hoeveelheid voedsel op de schijf of in de kom achter.

Tabel voor aanbevolen gebruik

G 	 MAX (g)	 (sec.)
	750 ml 	10-20
	750 ml 	10-20
	 MAX (g)	 (sec.)
	750 ml 	10-20

Uw Express Serve gebruiken

Gebruiksdiagrammen en gebruiksaanwijzing

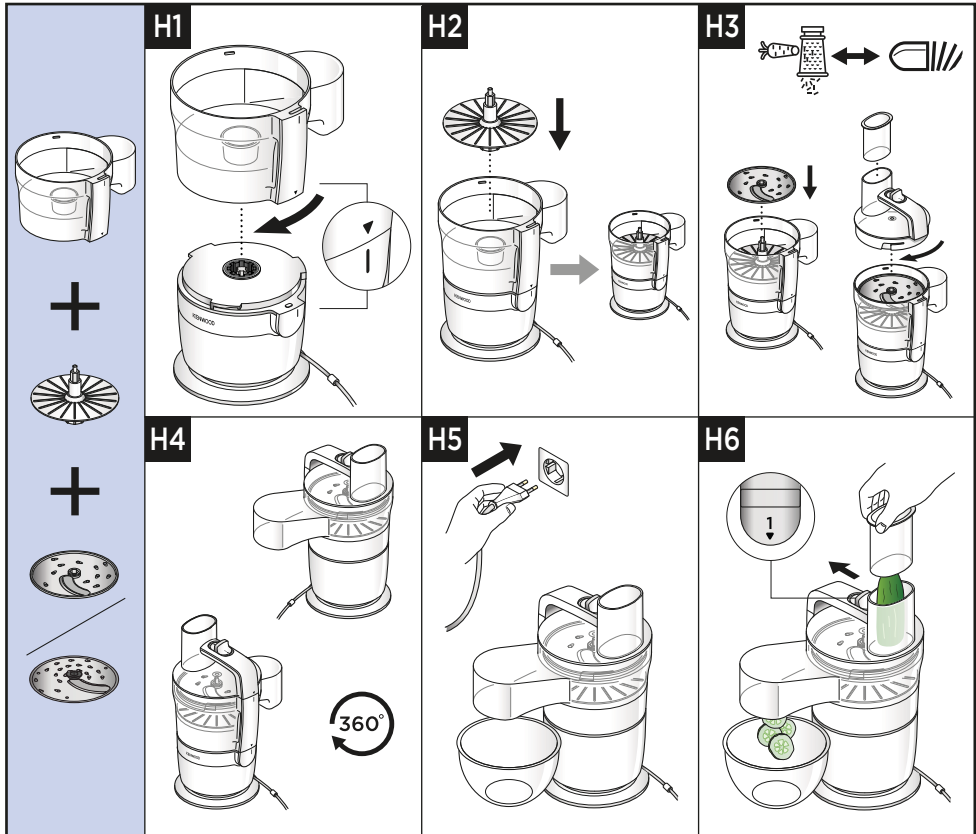











Belangrijk

- Gebruik nooit kracht wanneer u dit hulpstuk gebruikt.
- Als er geen voedsel uit de uitlaatopening komt, zet het apparaat dan uit en controleer dat er geen voedsel is opgehoopt onder de schijf en dat de slingerplaat is aangebracht. Verwijder opgehoopt voedsel alvorens verder te gaan.

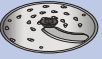
- 1 Zet de kom op het motorblok en draai hem rechtsom vast.
- 2 Plaats de slingerplaat en de benodigde schijf.
- 3 Zet het deksel op zijn plaats.
- 4 Doe de ingrediënten in de vulopening.
- 5 Steek de stekker in het stopcontact, selecteer snelheid 1 en duw de ingrediënten gelijkmatig met de stamper naar beneden.

Tabel voor aanbevolen gebruik

I 	 MAX (g)	 (sec.)
		120
		120
	 MAX (g)	 (sec.)
		120

Uw Personal Blender/hakhulpstuk gebruiken

Gebruiksdiagrammen en gebruiksaanwijzing

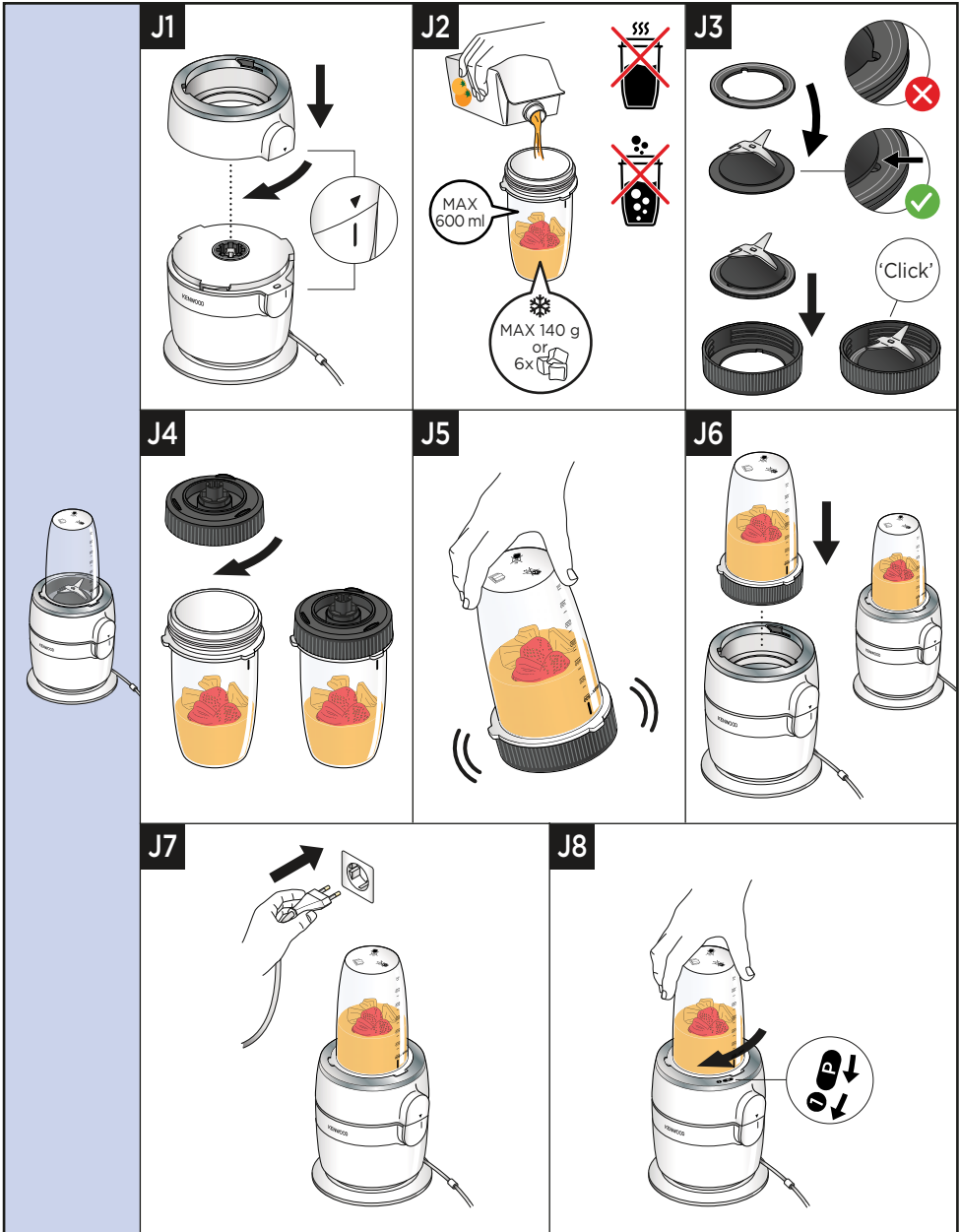

Uw Personal Blender/hakhulpstuk gebruiken

Gebruiksdiagrammen en gebruiksaanwijzing

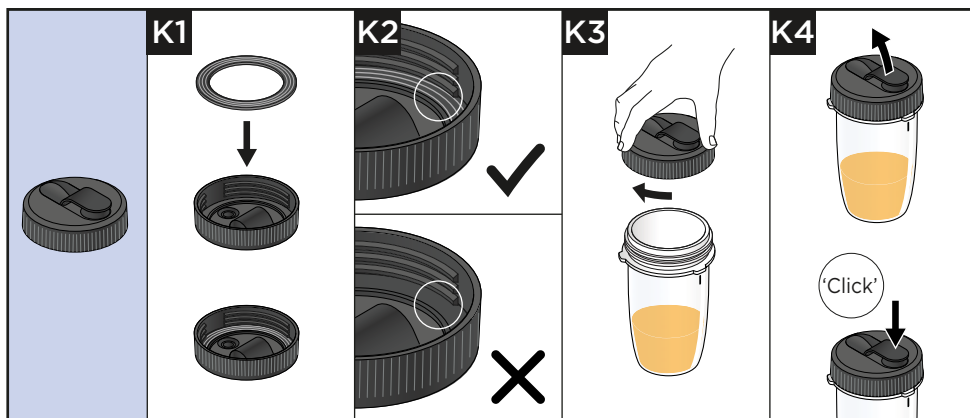

Belangrijk

- De voet van de Personal Blender of het hakhulpstuk moet op het motorblok worden gezet alvorens u de Personal Blender of het hakhulpstuk plaatst.
- Meng bevroren ingrediënten nooit zonder vloeistof (behalve ijsblokjes).
- Als de afdichting beschadigd of verkeerd geplaatst is, zal de blender lekken.
- Meng nooit diepgevroren ingrediënten die tot een dichte massa zijn bevroren.
- Meng **nooit** bevroren stukjes fruit of groente die groter zijn dan 3 cm x 3 cm.
- Voor de beste mengresultaten doet u ijs of bevroren ingrediënten altijd eerst in het maatglas.
- Haal **altijd** de pitten uit gedroogd fruit alvorens dat te hakken.

- 1 Plaats de voet van de Personal Blender of het hakhulpstuk op het motorblok en draai hem rechtsonder vast.
- 2 Doe ingrediënten in de beker, maximaal tot de markering voor 600 ml.
- 3 Plaats de afdichting op het meselement; zorg er hierbij voor dat de afdichting goed in het gedeelte met de ribbels zit.
- 4 Duw het meselement voorzichtig in de meshouder en klem het op zijn plaats vast.
- 5 Houd de onderkant van de houder met het meselement vast en laat die met de messen naar beneden gericht op de beker zakken.
- 6 Schroef de meshouder met het meselement op de beker – draai hem rechtsonder om hem vast te zetten.
- 7 Schud om de ingrediënten te verdelen.
- 8 Zet het hulpstuk op het motorblok.
- 9 Steek de stekker in het stopcontact. Selecteer pulseren door het hulpstuk rechtsonder (naar P) te draaien en los te laten. Selecteer continue snelheid door het hulpstuk rechtsonder (naar 1) te draaien totdat het op zijn plaats klikt.











Drinkdeksel

- 10 Plaats de afdichtring op het drinkdeksel; zorg er hierbij voor dat de afdichtring goed in het gedeelte met de ribbels zit.
- 11 Als u het drinkdeksel wilt gebruiken, schroeft u de meshouder met het meselement van de beker. Plaats het drinkdeksel door het rechtsom te draaien.
- 12 Wanneer u wilt drinken, klapt u gewoon de klep van het deksel open. De drank kan rechtstreeks uit de beker worden gedronken.
- 13 Klap de klep van het deksel na het drinken weer dicht. Druk hem stevig dicht.

Tips

- Als de beker tot de maximale capaciteit gevuld is (600 ml), is dat ongeveer twee porties.
- Als u uw drank niet meteen drinkt, bewaar die dan in de koelkast en drink hem binnen 24 uur.
- Zorg dat uw drankje dun genoeg is om hem door het drinkdeksel te drinken. U kunt een drankje dunner maken door er meer vloeistof aan toe te voegen.
- Na het mengen zijn sommige dranken mogelijk niet helemaal glad door de aanwezigheid van zaden of de vezelige aard van sommige ingrediënten.
- Sommige dranken kunnen schiften als u ze laat staan; u kunt ze daarom het best onmiddellijk opdrinken. Roer geschifte dranken voordat ze worden genuttigd.
- Houd de beker altijd rechtop als het drinkdeksel is geplaatst.

Tabel voor aanbevolen gebruik

L		 MAX (g)		 (sec.)
	 3 cm	600 ml	1	30-60
		100 g	10-20	P
		X 6 120-140 g	P	10-20
		50 g	P	10-20
		100 g	1	30-60
		50 g	P	10

Recepten

Pesto

60 g verse basilicum
1 teentje knoflook
25 g pijnboompitten
25 g geraspte Parmezaanse kaas
110 g olijfolie
Zout - naar wens
Peper - naar wens

- 1 Doe alle ingrediënten in blender of het hakhulpstuk. Pulseer 5 keer, gevolgd door continue verwerking totdat de gewenste consistentie is bereikt (ongeveer 25 seconden).

Pruimenmarinade

300 g honing
40 g pruimen
70 ml water

- 1 Doe alle ingrediënten in blender of het hakhulpstuk. Laat dit een hele nacht in de koelkast staan. (Ingrediënten niet langer dan 24 uur in de beker bewaren).
- 2 Verwerk 4 seconden lang met de pulseerfunctie. Onmiddellijk gebruiken.

Snoer afstellen

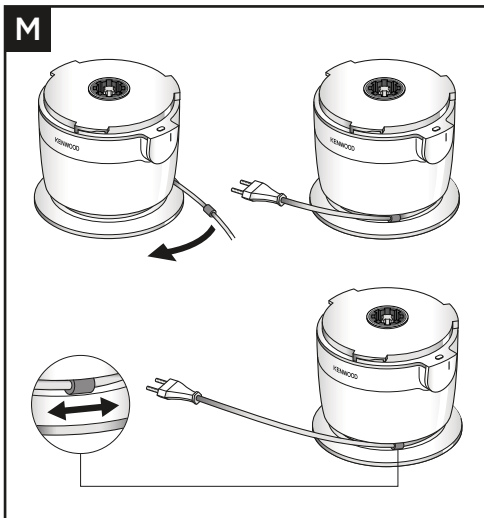

- Wikkel het snoer om de onderkant van de foodprocessor totdat de gewenste lengte is verkregen en klem het snoer met de snoerklem vast.

Opslag

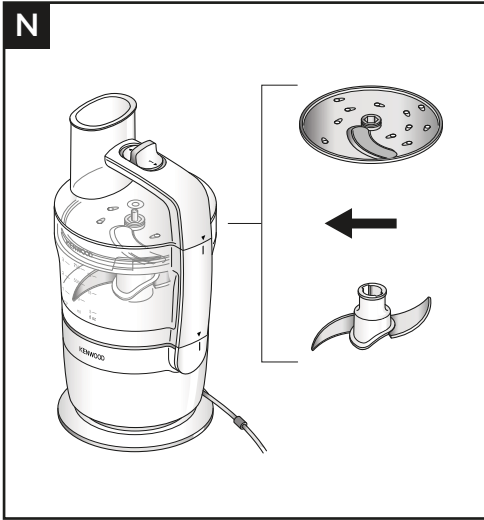

- Na gebruik kunnen het meselement en één schijf samen in de kom worden opgeborgen.
- De tweede schijf (indien geleverd) kan in de kom van de Express Serve worden opgeborgen.
- Gebruik de foodprocessor nooit als zowel het mes als een schijf zijn aangebracht. Gebruik slechts één hulpstuk tegelijk.

Onderhoud en klantenservice

- Als u problemen ondervindt met de werking van de machine, raadpleegt u de informatie onder 'Problemen oplossen' in deze handleiding of gaat u naar www.kenwoodworld.com.
- Dit product is gedekt door een garantie die voldoet aan alle wettelijke regels voor bestaande garanties en consumentenrechten die gelden in het land waar het product is gekocht.
- Als uw Kenwood product niet goed functioneert of als u defecten opmerkt, kunt u het naar een erkend Service Center van KENWOOD sturen of brengen. Voor informatie over het KENWOOD Service Center bij u in de buurt gaat u naar www.kenwoodworld.com of naar de specifieke website in uw land.
- Ontworpen en ontwikkeld door Kenwood in het VK.
- Vervaardigd in China.



BELANGRIJKE INFORMATIE VOOR DE JUISTE VERWIJDERING VAN HET PRODUCT VOLGENS DE EUROPESE RICHTLIJN BETREFFENDE AFGEDANKTE ELEKTRISCHE EN ELEKTRONISCHE APPARATUUR (AEEA)

Aan het einde van de levensduur van het product mag het niet samen met het gewone huishoudelijke afval worden verwijderd. Het moet naar een speciaal centrum voor gescheiden afvalinzameling van de gemeente worden gebracht, of naar een verkooppunt dat deze service verschaft.

Problemen oplossen

Probleem	Oorzaak	Oplossing
De foodprocessor werkt niet.	Geen stroom.	Controleer of de stekker in het stopcontact zit.
	De kom is niet juist op het motorblok geplaatst.	De foodprocessor werkt niet als de kom of het deksel niet goed in de vergrendeling zijn geplaatst.
	Het deksel van de kom is niet juist vergrendeld.	Controleer dat de kom en het deksel op één lijn staan en goed zijn vergrendeld.
Foodprocessor stopt tijdens de verwerking van ingrediënten.	Foodprocessor te zwaar belast/maximale capaciteit overschreden.	Controleer maximumcapaciteit in de tabel voor aanbevolen gebruik.
	Deksel niet vergrendeld.	Controleer dat het deksel goed is vergrendeld.
Kan de kom niet op de onderkant plaatsen als het deksel is aangebracht.	De aan/uit-knop staat in de stand 'Aan'.	Zet de knop in de stand 'Uit'.
Er komt geen voedsel uit de uitlaatopening van de Express Serve.	De slingerplaat is niet aangebracht onder de schijf voor snijden/raspen.	Plaats de slingerplaat.
Schijfjes of geraspte ingrediënten beschadigd door het mes.	U werkt met zowel het mes als de schijf in de kom geplaatst.	Verwijder het mes alvorens de schijf voor snijden/raspen te plaatsen.
Eenheid is onstabiel/heftige trillingen en beweging.	Deeg wordt te lang verwerkt.	Gebruik het handvat op het deksel als stabilisator als het apparaat op het werkblad begint te bewegen. Verwerk deeg nooit langer dan 30 seconden en gebruik nooit meer dan de maximale hoeveelheid die wordt vermeld in de tabel voor aanbevolen gebruik.
	Deeg wordt opnieuw gekneet.	Kneet het deeg alleen met de hand opnieuw. Opnieuw kneden in de kom wordt afgeraden omdat de foodprocessor dan instabiel kan worden.
	Er worden plakkerige vruchten/ingrediënten zoals dadels verwerkt.	Voor de beste resultaten gebruikt u eerst 'Pulseren' om de ingrediënten op te breken en verwerkt u deze daarna in continu bedrijf.
Veel spatten of ingrediënten worden uit de toevoerbus geworpen.	Stamper niet aangebracht.	Breng altijd de stamper aan als u deeg, gebak en cake verwerkt; dit om spatten uit de toevoerbus te voorkomen.
Het mes en de schijf werken niet goed.	Raadpleeg de hints en tips en volg de aanbevelingen in de tabel voor aanbevolen gebruik.	

Problemen oplossen

Probleem	Oorzaak	Oplossing
Personal Blender/ hakhulpstuk werkt niet.	Personal Blender/ hakhulpstuk niet goed vastgezet Voet van Personal Blender/ hakhulpstuk niet goed vastgezet	Personal Blender/hakhulpstuk werkt niet indien niet goed in de vergrendeling geplaatst.
Personal Blender/ hakhulpstuk lekt uit de onderkant van het meselement.	De afsluitring ontbreekt. De afsluitring is onjuist aangebracht. De afsluitring is beschadigd. Meshouder niet helemaal/ niet goed vastgezet.	Controleer of de meshouder er goed is opgeschroefd. Controleer of de afdichting goed in de groef is geplaatst, zoals aangegeven in diagram J3, en of die misschien beschadigd is. Voor een vervangende afsluitring raadpleegt u de informatie onder 'Onderhoud en klantenservice'.
Personal Blender/ hakhulpstuk lekt uit het drinkdeksel.	Deksel ontgrendeld.	Controleer of het deksel goed is vergrendeld.

Français

- Informations importantes en matière de sécurité 50-52
- Avant de brancher l'appareil 52
- Nettoyage et entretien 53-54
- Liste des éléments 55-56
- Utilisation de votre bol multifonction - Lame de couteau 57-60
 - Diagrammes et instructions d'utilisation 57-58
 - Tableau d'utilisation 59
 - Recette 60
- Utilisation de votre bol multifonction - Disques 60-61
 - Diagrammes et instructions d'utilisation 60-61
 - Tableau d'utilisation 61
- Utilisation de votre accessoire Express Serve 62-63
 - Diagrammes et instructions d'utilisation 62
 - Tableau d'utilisation 63
- Utilisation de votre blender/hachoir personnel 64-68
 - Diagrammes et instructions d'utilisation 64-66
 - Tableau d'utilisation 67
 - Recette 68
- Réglage du cordon 68
- Rangement 69
- Service après-vente 70
- Guide de dépannage 71-72

Informations importantes en matière de sécurité



- Lisez et conservez soigneusement ces instructions pour pouvoir vous y référer ultérieurement.
- Avant la première utilisation, retirez tous les emballages, la documentation commerciale et les couvercles de lames en plastique. Lavez les pièces : voir 'Nettoyage et entretien'.
- Si le cordon ou la prise sont endommagés, il faut les faire remplacer, pour des raisons de sécurité, par Kenwood ou un réparateur agréé par Kenwood pour éviter tout accident.
- **NE TOUCHEZ PAS les lames, elles sont tranchantes.** Les lames et les disques sont très tranchants, manipulez-les avec précaution. **Tenez toujours les ustensiles et accessoires par la partie supérieure, loin des zones coupantes, lorsque vous les manipulez, que vous videz le bol ou pendant le nettoyage.**
- **Le bol multifonction et le bol express serve ne permettent pas l'utilisation de glaçons.**
- Avant de soulever ou de porter l'appareil par la poignée du couvercle, vérifiez toujours que le bol et le couvercle sont bien solidement enclenchés.
- **Ne placez pas** d'ingrédients chauds dans l'un des récipients fournis, y compris le blender personnel. Les liquides chauds peuvent être projetés de l'appareil en cas d'évaporation soudaine.
- **Ne laissez jamais** l'appareil sans surveillance lorsqu'il fonctionne.
- **Ne déplacez pas** l'appareil pendant son fonctionnement.
- **Ne dépassez pas** les capacités maximales données dans le tableau des conseils d'utilisation.
- **Ne faites pas fonctionner votre appareil pendant plus de 30 secondes lorsque vous travaillez de la pâte sans pause de 5 minutes. Un fonctionnement continu pendant des périodes prolongées peut endommager votre appareil.**
- Retirez **toujours** la lame du couteau et les disques avant de verser le contenu du bol multifonction.
- Gardez les mains et les ustensiles à l'écart du bol multifonction lorsqu'il est branché sur le secteur.
- Si les aliments doivent être poussés vers le bas dans le bol multifonction, utilisez un ustensile approprié tel qu'une spatule.
- **Ne poussez jamais** la nourriture dans le goulotte d'alimentation avec les doigts. Utilisez toujours le poussoir fourni avec l'appareil.
- Éteignez **toujours** l'appareil et débranchez-le de l'alimentation lorsque vous devez le laisser sans surveillance et avant d'installer de retirer, ou de nettoyer les accessoires.
- ATTENTION : avant de retirer le couvercle du bol, attendez que l'accessoire/ les lames soient complètement arrêtés.
- **N'exercez pas** de force excessive pour pousser la nourriture dans le tube d'alimentation, vous pourriez endommager votre appareil.
- **N'utilisez pas** le verrouillage du couvercle pour faire fonctionner le bol multifonction, utilisez toujours le bouton.

- **Ne faites pas** fonctionner le robot si la lame du couteau et un disque sont montés. N'utilisez qu'un seul accessoire à la fois.
- **Cette machine sera endommagée et pourrait provoquer des blessures si le mécanisme de verrouillage est soumis à une force excessive.**
- N'utilisez **jamais** un accessoire non autorisé.
- N'utilisez **jamais** un appareil endommagé. Faites-le vérifier ou réparer : voir « Service après-vente ».
- **Ne mouillez jamais** le bloc moteur, le cordon d'alimentation ou la prise.
- **Ne laissez pas** le cordon d'alimentation dépasser du bord d'une table, du plan de travail ou être en contact avec des surfaces chaudes.
- Les enfants doivent être surveillés afin qu'ils ne puissent pas jouer avec cet appareil.
- Cet appareil ne doit pas être utilisé par des enfants. Veuillez garder l'appareil et le cordon hors de portée des enfants.
- Les appareils peuvent être utilisés par des personnes dont les capacités physiques, sensorielles ou mentales sont diminuées, ou qui ne disposent pas des connaissances ou de l'expérience nécessaires, si elles ont été formées et encadrées pour l'utilisation des appareils, et si elles ont conscience des risques encourus.
- N'employez l'appareil qu'à la fin domestique prévue. Kenwood décline toute responsabilité dans les cas où l'appareil est utilisé incorrectement ou quand les présentes instructions ne sont pas respectées.
- Toute mauvaise utilisation de votre appareil peut provoquer des blessures.

Express Serve

- Évitez tout contact avec les pièces mobiles. Maintenez vos doigts hors de l'orifice de sortie des aliments.
- N'utilisez pas l'appareil sans que le disque d'éjection soit installé. **Le non-respect de cette consigne entraîne l'accumulation des aliments sous les disques et les aliments ne sortent pas, entraînant de possibles dommages à votre accessoire.**
- Si les aliments ne sortent pas par la sortie des aliments, éteignez l'appareil et vérifiez que les aliments ne s'accumulent pas sous le disque et que le disque d'éjection est installé. Dégagez tous les aliments coincés avant de poursuivre l'utilisation de l'appareil.
- **Ne faites pas fonctionner l'accessoire Express Serve en continu pendant plus de 2 minutes. Laissez refroidir pendant 2 minutes entre chaque fonctionnement de 2 minutes.**

Sécurité du blender/hachoir personnel

-  **NE travaillez PAS** avec des ingrédients chauds.
-  **NE mixez PAS** des liquides gazeux.
- **RISQUE DE BRÛLURES** : Les ingrédients chauds doivent être refroidis à température ambiante avant d'être placés dans de le placer dans le gobelet ou de le mélanger.
- Ne pas conserver les ingrédients dans le gobelet pendant plus de 24 heures.
- Prenez **toujours** des précautions lorsque vous manipulez l'ensemble porte-lames et évitez de toucher le bord tranchant des lames lors du nettoyage.

- Ne faites **jamais** fonctionner le blender/hachoir à vide.
- Recettes de smoothie - ne mélangez jamais des ingrédients congelés qui ont formé une masse solide pendant la congélation, brisez-les avant de les ajouter dans le gobelet.
- Utilisez le gobelet uniquement avec l'ensemble de lames fourni.
- **Ne buvez jamais** de liquides chauds directement depuis le gobelet.
- Lorsque vous utilisez le couvercle pour consommer votre boisson, assurez-vous qu'elle est homogène. Vous aurez peut-être besoin d'acquiescer de l'expérience avant d'obtenir les résultats souhaités, notamment lorsque vous préparez des aliments fermes ou qui ne sont pas mûrs. En effet, certains ingrédients peuvent ne pas être mixés.
- **Ne mixez pas** les ingrédients surgelés sans liquide (à l'exception des glaçons)
- **Ne mélangez jamais** de cubes de fruits ou légumes congelés de plus 3 cm x 3 cm
- **Ne mélangez jamais** les ingrédients secs (par ex. épices, noix) et ne faites jamais fonctionner le blender/hachoir à vide.
- **N'installez jamais** l'ensemble de lames sur le bloc moteur sans que le gobelet soit installé.
- Retirez **toujours** les noyaux des fruits secs avant de les hacher.

Consommation électrique

- Lorsque l'appareil ne fonctionne pas
 - Commutation automatique en mode arrêt (OFF) : Non applicable
 - Consommation en mode arrêt : <0,3 W.

Avant de brancher l'appareil

- Assurez-vous que l'alimentation électrique correspond à celle qui est indiquée sur la partie inférieure de votre appareil.
- Cet appareil est conforme au règlement 1935/2004 de la CE sur les matériaux et les articles destinés au contact alimentaire.











Avant toute première utilisation

- 1 Retirez les protections en plastique de la lame du couteau. Attention, les lames sont très tranchantes. Ces protections doivent être jetées car elles ne servent à la protection des lames que pendant la fabrication et le transport.
- 2 Lavez les pièces : voir la section consacrée au nettoyage.

Nettoyage et entretien

			
	X	X	✓
	✓	✓	X
	✓	✓	X
	✓	✓	X
	✓	✓	X
	✓	✓	X
	✓	✓	X
	✓	✓	X
	✓	✓	X

Nettoyage et entretien

○			
	X	X	✓
	✓	✓	X
	✓	✓	X
	✓	✓	X
	✓	✓	X
	✓	✓	X
	✓	✓	X

- Mettez hors tension, attendez l'arrêt de l'accessoire/des lames et débranchez avant de nettoyer.
- Essuyez le bloc moteur avec un chiffon humide, puis séchez. Vérifiez qu'il ne reste aucun débris alimentaire dans la zone de verrouillage.
- N'immergez pas le socle d'alimentation dans l'eau.
- Manipulez les lames et les disques de coupe avec précaution ; ils sont extrêmement tranchants.
- Si vous lavez les lames du blender/hachoir à la main, vous devez les brosser et les rincer à l'eau courante.

Liste des éléments

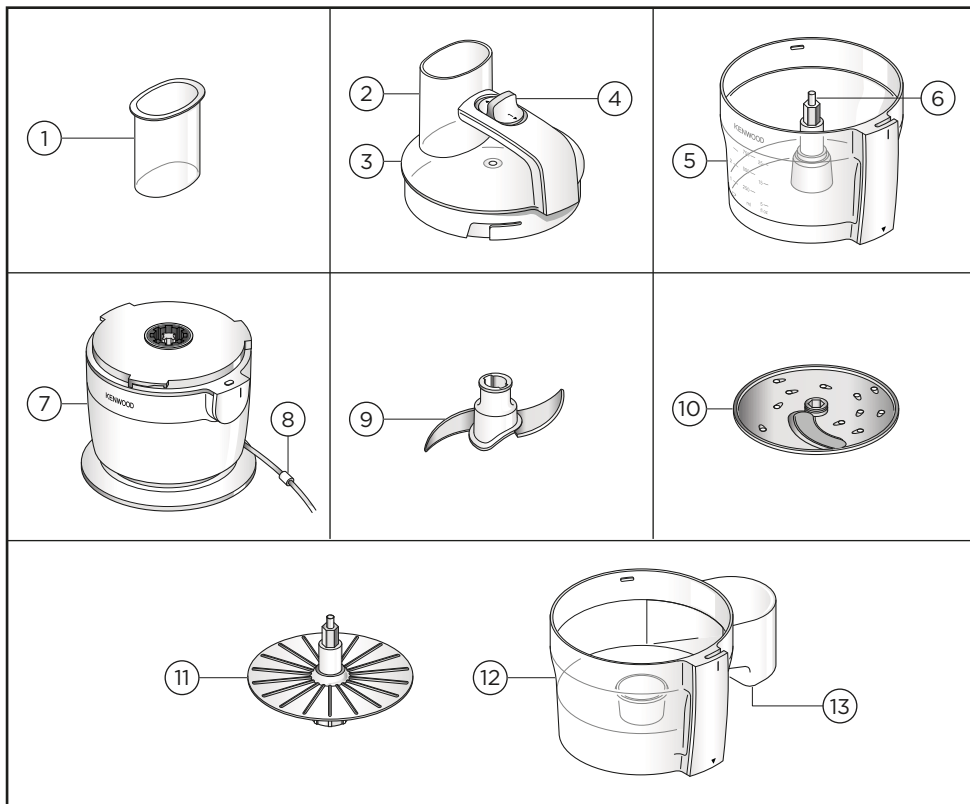

* Si fourni

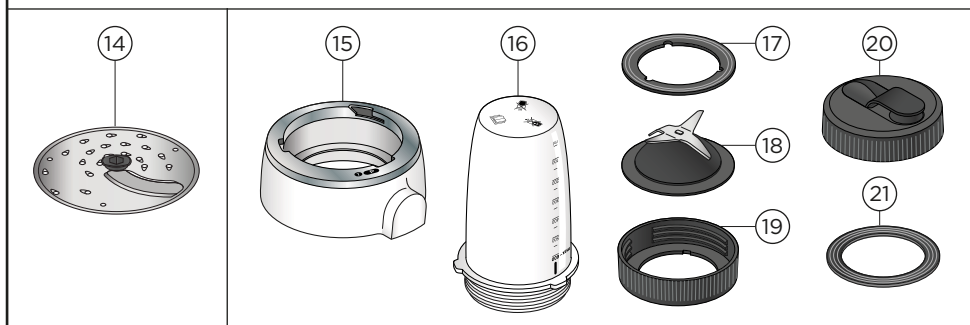

Légende

Bol multifonction

- ① Poussoirs
- ② Goulotte d'alimentation
- ③ Couvercle
- ④ Interrupteur On/Off + Pulse
- ⑤ Bol
- ⑥ Entraînement dans le bol
- ⑦ Bloc moteur
- ⑧ Pince du cordon
- ⑨ Lame couteau
- ⑩ Disque éminceur/râper 4 mm

Express Serve

- ⑪ Disque d'éjection
- ⑫ Bol Express serve
- ⑬ Sortie des aliments

Disque

- ⑭ Disque éminceur/râper 2 mm (si fourni)

Blender/Hachoir personnel

- ⑮ Base du blender/hacheur personnel
- ⑯ Gobelet
- ⑰ Anneau d'étanchéité
- ⑱ Unité de lames
- ⑲ Porte-lame
- ⑳ Couvercle à boire
- ㉑ Anneau d'étanchéité du couvercle de boisson

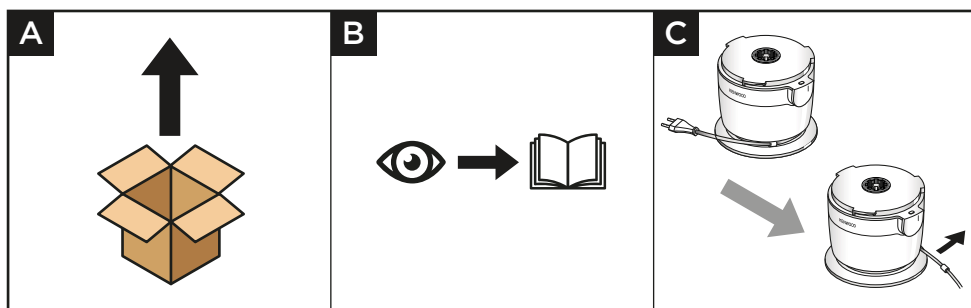

Utilisation de votre bol multifonction - Lame de couteau

Diagrammes et instructions d'utilisation

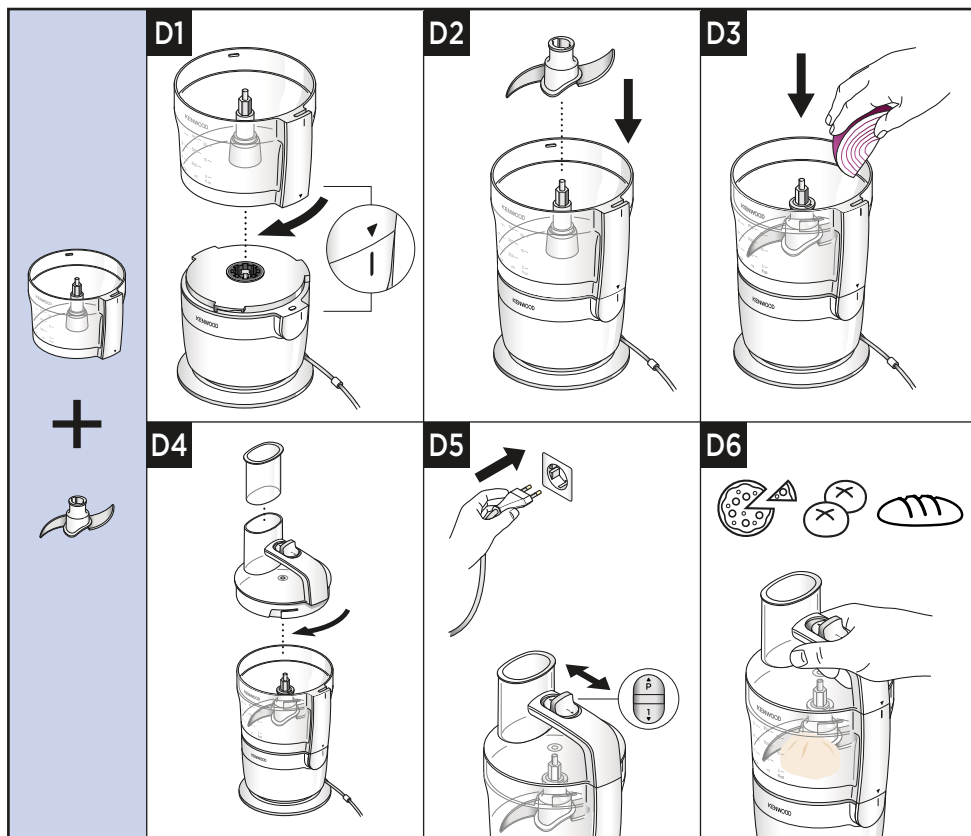

Important























- Votre robot ne convient pas pour broyer ou mouder les grains de café et les épices, pour transformer le sucre cristallisé en sucre en poudre ni pour piler des glaçons.
- Si vous ajoutez de l'essence d'amandes ou un parfum aux préparations, évitez le contact avec le plastique car il risquerait d'être définitivement taché.
- Installez toujours le bol et l'accessoire sur le robot avant d'ajouter des ingrédients.
- N'ouvrez pas le couvercle pour arrêter le robot.
- L'appareil ne fonctionnera pas si le bol ou le couvercle ne sont pas correctement insérés et verrouillés. Vérifiez que la d'alimentation et la poignée du bol sont bien situés dans le coin avant droit.
- Éteignez toujours l'appareil et débranchez-le avant de retirer le couvercle.
- Ne travaillez pas plus de 30 secondes les pâtes à pain.
- Pétrissez à nouveau la pâte à pain à la main uniquement. Il n'est pas recommandé de recommencer le pétrissage dans le bol car cela risquerait de rendre le robot instable.
- Tenez toujours l'appareil par la poignée lorsque vous travaillez la pâte.

- 1 Placez le bol sur le bloc moteur et tournez-le dans le sens des aiguilles d'une montre.
- 2 Placez la lame de couteau sur l'arbre d'entraînement.
- 3 Ajoutez les ingrédients dans le bol multifonction.
- 4 Mettez le couvercle en place.
- 5 Branchez l'appareil sur le secteur.
- 6 Allumez l'appareil ou utilisez la fonction d'impulsion.

Conseils et astuces

- Utilisez la touche pulse (P) pour de petites impulsions. La fonction pulse fonctionne tant que la touche est maintenue en position.
- Certains aliments peuvent décolorer le plastique. C'est tout à fait normal et cela n'endommagera pas le plastique ni n'affectera le goût de votre nourriture. Frottez avec un chiffon trempé dans de l'huile végétale pour éliminer la décoloration.
- **Pâte à pain** - Mettez d'abord les ingrédients secs dans le bol, puis ajoutez le liquide. Mélangez jusqu'à l'obtention d'une boule de pâte élastique et lisse.
- Utilisez la poignée du couvercle pour stabiliser l'appareil s'il commence à bouger sur le plan de travail.
- Pour les mélanges épais, utilisez la fonction pulse.
- Prenez garde à ne pas mélanger trop longtemps.
- Pour la préparation de pâtes à tarte, utilisez la matière grasse sortie directement du réfrigérateur et coupez-la en cubes de 2 cm.

Tableau d'utilisation

E	 MAX (g)	 (sec)
	20-30	10-20
	200	30
	150	20-30
	300	10/P
	200	P
	250	15-20
	100-200	20
	400	60
	x3  + 300 ml 	45-60
	250 g  + 150 g 	30
	250 g 	10-30
	 x3 +  150 g +  150 g ^{18-22° C} +  150 g	20

Recette

Marinade de pruneaux

400 g miel

40 g pruneaux

50 ml d'eau

- 1 Conservez au réfrigérateur pendant une nuit.
- 2 Actionnez pendant 4 secondes en utilisant la fonction Pulse.

Utilisation de votre bol multifonction - Disques

Diagrammes et instructions d'utilisation

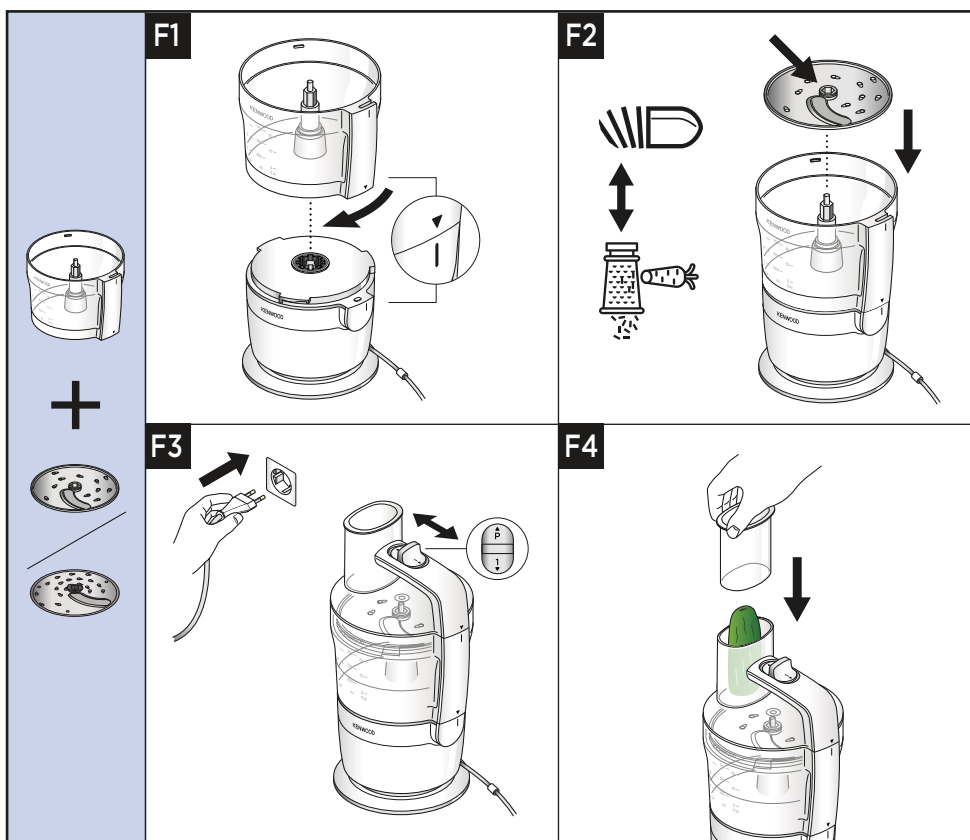

Important













- N'insérez jamais vos doigts dans la cheminée d'alimentation.

- 1 Placez le bol sur le bloc moteur et tournez-le dans le sens inverse des aiguilles d'une montre pour le verrouiller.
- 2 Tout en le maintenant par sa poignée centrale, placez le disque sur l'axe d'entraînement, face appropriée vers le haut.
- 3 Fixez le couvercle.
- 4 Placez les aliments dans le goulotte d'alimentation.
- 5 Branchez, passez en vitesse 1 et appuyez uniformément avec le poussoir.

Conseils et astuces

- Utilisez des ingrédients frais.
- Ne coupez pas les aliments trop petits. Remplissez la largeur du goulotte d'alimentation avec vos ingrédients (en évitant de les serrer), cela empêchera les aliments de glisser sur le côté pendant le traitement.
- Lorsque vous émincez ou vous râpez : les aliments placés verticalement ressortent plus courts que ceux placés horizontalement.
- Il reste toujours une petite quantité d'aliments sur le disque ou dans le bol après utilisation de l'appareil.

Tableau d'utilisation

G 	 MAX (g)	 (sec)
	750 ml 	10-20
	750 ml 	10-20
	 MAX (g)	 (sec)
	750 ml 	10-20

Utilisation de votre accessoire Express Serve

Diagrammes et instructions d'utilisation

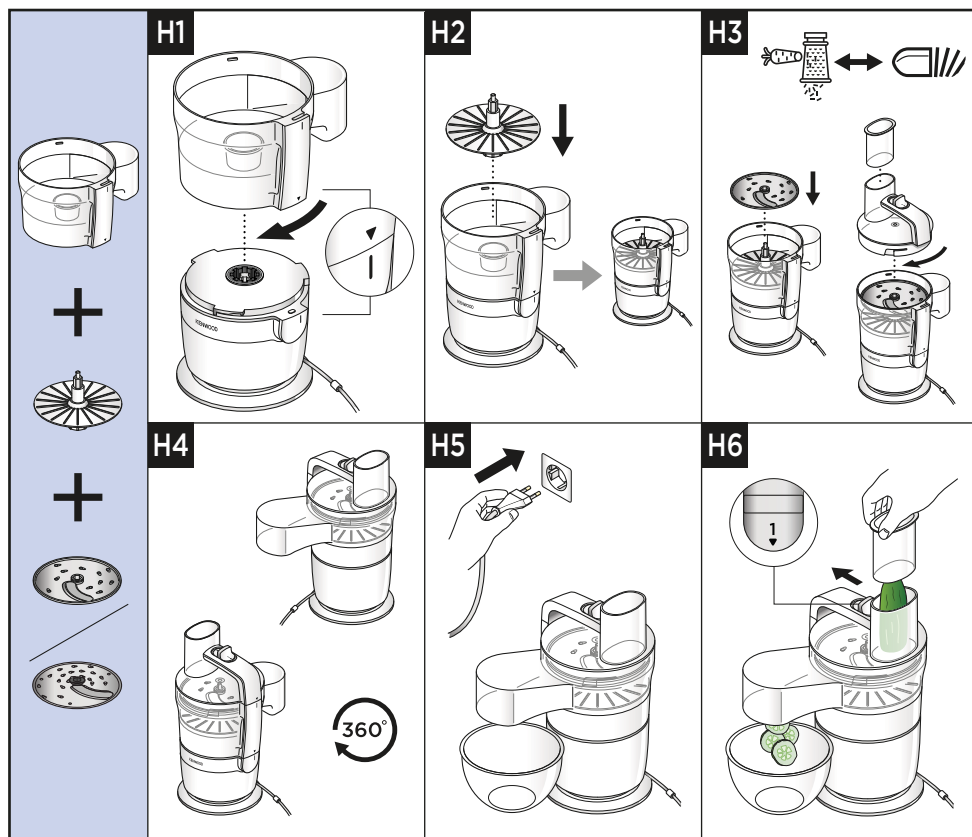











Important

- N'exercez pas de force excessive lors de l'utilisation de l'accessoire.
- Si les aliments ne sortent pas par la sortie des aliments, éteignez l'appareil et vérifiez que les aliments ne s'accumulent pas sous le disque et que le disque d'éjection est installé. Dégagez tous les aliments coincés avant de poursuivre l'utilisation de l'appareil.

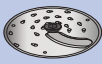
- 1 Placez le bol sur le bloc moteur et tournez-le dans le sens des aiguilles d'une montre.
- 2 Installez le disque d'éjection et le disque nécessaire.
- 3 Installez le couvercle.
- 4 Placez les aliments dans le goulotte d'alimentation.
- 5 Branchez, passez en vitesse 1 et appuyez uniformément avec le poussoir.

Tableau d'utilisation

I 	 MAX (g)	 (sec)
		120
		120
	 MAX (g)	 (sec)
		120

Utilisation de votre blender/hachoir personnel

Diagrammes et instructions d'utilisation

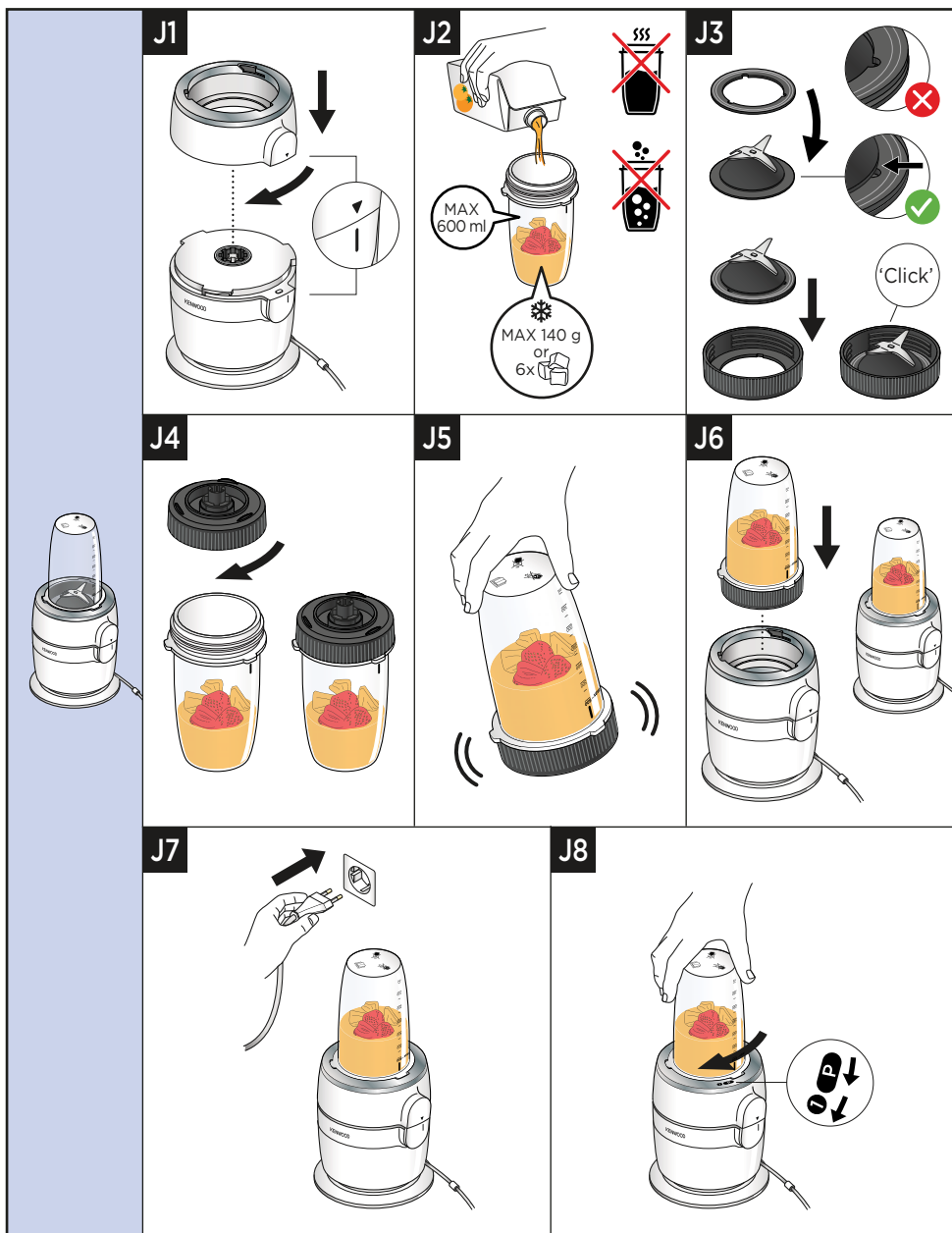

Utilisation de votre blender/hachoir personnel

Diagrammes et instructions d'utilisation

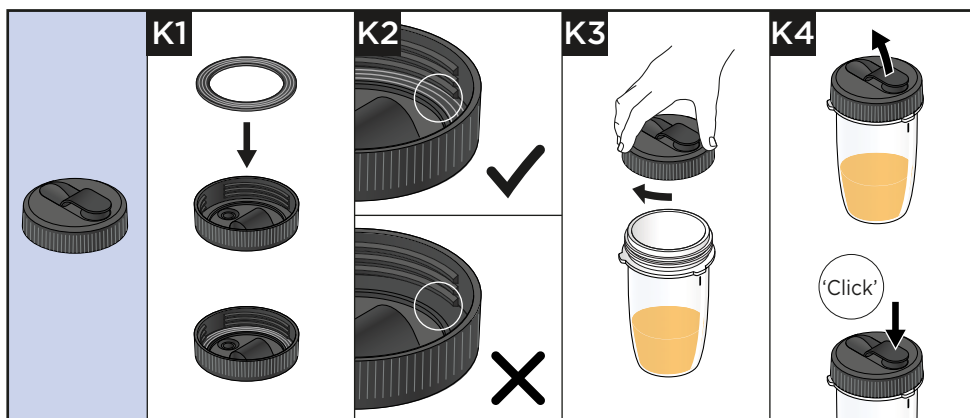

Important

- La base du blender/hachoir personnel doit être installée sur le bloc moteur avant installation du blender/hachoir personnel.
- Ne mixez pas les ingrédients surgelés sans liquide (à l'exception des glaçons).
- Ne mélangez jamais de cubes de fruits ou légumes congelés de plus 3 cm x 3 cm
- Des fuites se produisent si l'anneau d'étanchéité est endommagé ou mal monté
- Ne mélangez jamais des ingrédients congelés ayant formé une masse solide.
- Pour un mixage optimal, ajoutez toujours les ingrédients glacés/congelés en premier dans la bouteille.
- Retirez **toujours** les noyaux des fruits secs avant de les hacher.

- 1 Placez la base du blender/hachoir personnel sur le bloc d'alimentation, tournez dans le sens des aiguilles d'une montre pour verrouiller.
- 2 Ajoutez les ingrédients dans le gobelet, jusqu'à la marque de niveau de 600 ml.
- 3 Installez l'anneau d'étanchéité sur l'unité de lames, en veillant à ce que l'anneau soit correctement placé dans la zone rainurée.
- 4 Abaissez avec précaution l'unité de lames dans le porte-lame et enclenchez la pour bien sécuriser.
- 5 Tenez le dessous de l'unité de lames et faites-la descendre sur la bouteille, les lames orientées vers le bas.
- 6 Vissez l'ensemble porte-lame dans le gobelet - tournez dans le sens des aiguilles d'une montre pour verrouiller.
- 7 Agitez pour répartir les ingrédients.
- 8 Abaissez l'accessoire sur le bloc moteur.
- 9 Branchez. Pour sélectionner la vitesse d'impulsion, tournez dans le sens des aiguilles d'une montre (vers P) et relâchez l'accessoire. Pour sélectionner la vitesse continue, tournez l'accessoire dans le sens des aiguilles d'une montre (vers 1) jusqu'à ce qu'il s'enclenche.











Couvercle à boire

- 10 Installez l'anneau d'étanchéité sur le couvercle à boire, en veillant à ce que l'anneau soit correctement placé dans la zone rainurée.
- 11 Pour utiliser le couvercle, dévissez l'ensemble porte-lames assemblé du gobelet. Mettez en place le couvercle à boire en le tournant dans le sens des aiguilles d'une montre.
- 12 Pour boire, il suffit d'ouvrir en faisant basculer la languette du couvercle. La boisson peut être consommée directement à partir du gobelet.
- 13 Après avoir bu, refermez la languette sur le couvercle. Appuyez fermement pour la fixer.

Conseils et astuces

- Notez que lorsque le gobelet est rempli à sa capacité maximale (600 ml), cela représente environ deux portions.
- Si vous n'avez pas l'intention de consommer votre boisson immédiatement, conservez-la au réfrigérateur et consommez-la dans les 24 heures.
- Assurez-vous que votre boisson est suffisamment liquide pour être consommée par le couvercle verseur. Vous pouvez obtenir une boisson moins épaisse en ajoutant du liquide.
- Après le mixage, certaines boissons peuvent ne pas être totalement homogènes en raison de la nature fibreuse des ingrédients.
- Les ingrédients de certaines boissons peuvent se séparer lorsqu'ils reposent. Il est donc conseillé de consommer ces boissons immédiatement. Mélangez les boissons dont les ingrédients se sont séparés avant de les consommer.
- Lorsque le couvercle à boire est en place, le gobelet doit toujours être maintenu en position verticale.

Tableau d'utilisation

L		 MAX (g)		 (sec)
	 3 cm	600 ml	1	30-60
		100 g	10-20	P
		X 6 120-140 g	P	10-20
		50 g	P	10-20
		100 g	1	30-60
		50 g	P	10

Recettes

Pesto

60 g de basilic frais
1 gousse d'ail
25 g de pignons de pin
25 g de parmesan râpé
110 g d'huile d'olive
Sel - selon le goût
Poivre - selon le goût

- 1 Placez tous les ingrédients dans la tasse du blender/hachoir. Effectuez 5 impulsions puis fonctionnement en continu jusqu'à obtention de la consistance souhaitée (environ 25 secondes).

Marinade de pruneaux

300 g de miel
40 g de pruneaux
70 ml d'eau

- 1 Placez tous les ingrédients dans le gobelet du blender/hachoir. Conservez au réfrigérateur jusqu'au lendemain. (Ne conservez pas les ingrédients dans le gobelet pendant plus de 24 heures).
- 2 Actionnez pendant 4 secondes en utilisant la vitesse d'impulsion. À utiliser immédiatement.

Réglage du cordon

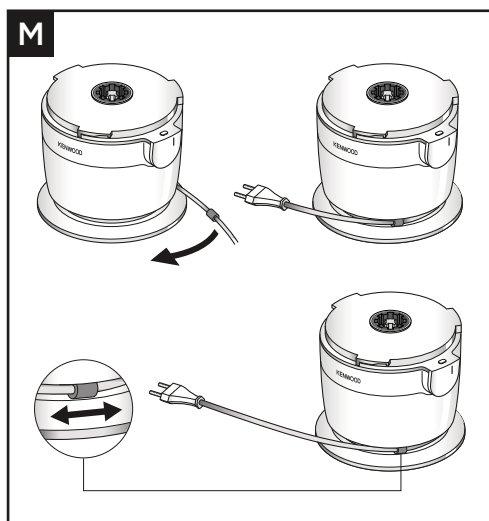

- Enroulez le cordon autour de la base du bol multifonction jusqu'à la longueur souhaitée et attachez-le avec la pince pour cordon.

Rangement

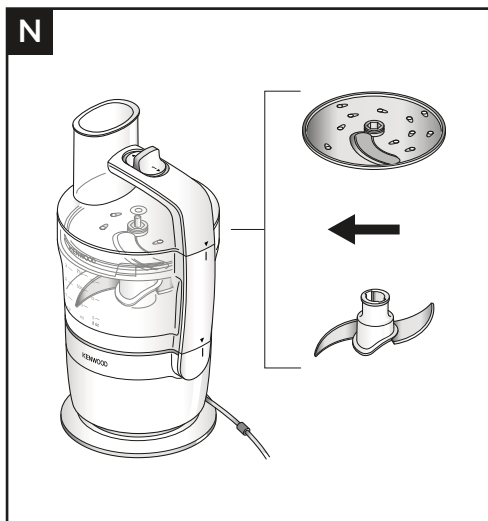

- Après utilisation, la lame du couteau et un disque peuvent être rangés ensemble dans le bol.
- Le deuxième disque (s'il est fourni) peut être rangé dans le bol express serve.
- Ne faites pas fonctionner le bol multifonction avec la lame de couteau et un disque installés. N'utilisez qu'un seul accessoire à la fois.

Service après-vente

- Si vous rencontrez des problèmes lors de l'utilisation de votre appareil, reportez-vous à la section « Guide de dépannage » de ce manuel ou consultez la page www.kenwoodworld.com avant de contacter le service après-vente.
- N'oubliez pas que votre appareil est couvert par une garantie, qui respecte toutes les dispositions légales concernant les garanties existantes et les droits du consommateur dans le pays où vous avez acheté le produit.
- Si votre appareil Kenwood fonctionne mal ou si vous trouvez un quelconque défaut, veuillez l'envoyer ou l'apporter à un centre de réparation KENWOOD autorisé. Pour trouver des détails actualisés sur votre centre de réparation KENWOOD le plus proche, veuillez consulter www.kenwoodworld.com ou le site internet spécifique à votre pays.
- Conçu et développé par Kenwood au Royaume-Uni.
- Fabriqué en Chine.



AVERTISSEMENTS POUR L'ÉLIMINATION CORRECTE DU PRODUIT CONFORMÉMENT AUX TERMES DE LA DIRECTIVE EUROPÉENNE RELATIVE AUX DÉCHETS D'ÉQUIPEMENTS ÉLECTRIQUES ET ÉLECTRONIQUES (DEEE).

Au terme de son utilisation, le produit ne doit pas être éliminé avec les déchets urbains. Le produit doit être remis à l'un des centres de collecte sélective prévus par l'administration communale ou auprès des revendeurs assurant ce service.

Guide de dépannage

Problème	Cause	Solution
Le bol multifonction ne fonctionne pas.	Pas d'alimentation électrique.	Vérifiez que le bol multifonction est branché.
	Le bol n'est pas installé correctement sur le bloc moteur.	Le bol multifonction ne fonctionnera pas si le bol ou le couvercle ne sont pas correctement insérés dans le dispositif de verrouillage.
	Le couvercle du bol n'est pas correctement verrouillé.	Vérifiez que le bol et le couvercle sont alignés et emboîtés correctement.
Le bol multifonction s'arrête pendant le fonctionnement.	Le bol multifonction est surchargé/les capacités maximales ont été dépassées.	Vérifiez les capacités maximum dans le Tableau des conseils d'utilisation.
	Le couvercle est déverrouillé.	Vérifiez que le couvercle est correctement verrouillé.
Impossible d'adapter le bol à la base avec le couvercle monté.	L'interrupteur On/Off est sur la position « On ».	Placez l'interrupteur en position « off ».
Les aliments ne sortent pas de la sortie Express Serve.	Le disque d'éjection n'est pas installé sous la rape/le disque à émincer.	Fixez le disque d'éjection.
Coupez ou râpez les aliments abîmés par la lame du couteau.	Utilisation avec la lame de couteau et le disque installé dans le bol.	Retirez la lame du couteau avant d'utiliser le disque à râper/émincer.
Unité instable/mouvements importants et fortes vibrations.	Travail de la pâte pendant trop longtemps.	Utilisez la poignée du couvercle pour stabiliser l'appareil s'il commence à bouger sur le plan de travail.
	Le bol multifonction est surchargé/les capacités maximales ont été dépassées.	Ne travaillez pas les pâtes pendant plus de 30 secondes et ne dépassez pas la quantité maximale recommandé dans le tableau d'utilisation.
	Nouveau pétrissage de la pâte.	Pétrissez à nouveau à la main uniquement. Il n'est pas recommandé de recommencer le pétrissage dans le bol car cela risquerait de rendre le bol multifonction instable.
	Préparation de fruits ou ingrédients collants tels que des dattes.	Pour obtenir les meilleurs résultats, utilisez d'abord la fonction « Pulse » pour décomposer les ingrédients, puis utilisez le mode continu.

Guide de dépannage

Problème	Cause	Solution
Éclaboussures importantes ou ingrédients éjectés du goulotte d'alimentation.	Poussoir non installé.	Installez toujours le poussoir lorsque vous préparez de la pâte, de la pâtisserie et des gâteaux afin d'éviter les éclaboussures provenant du goulotte d'alimentation.
Mauvaises performances de la lame et du disque du couteau.	Consultez la section Conseils et astuces et suivez les recommandations du tableau d'utilisation.	
Le blender/hachoir personnel ne fonctionne pas.	Le blender/hachoir personnel n'est pas correctement verrouillé La base du blender/hachoir personnel n'est pas verrouillée correctement	Le blender/hachoir personnel ne fonctionnera pas s'il n'est pas correctement installé sur le dispositif de verrouillage.
Le blender/hachoir personnel fuit de la base de l'assemblage des lames.	Absence de joint d'étanchéité. Joint d'étanchéité mal fixé. Joint d'étanchéité endommagé. Le porte-lame n'est pas complètement/correctement serré.	Vérifiez que le porte-lame est bien vissé. Vérifiez que le joint est correctement inséré dans le sillon, comme sur l'illustration J3, et qu'il n'est pas endommagé. Pour obtenir le remplacement d'un joint d'étanchéité, consultez la section « Service après-vente».
Le blender/hachoir personnel fuit par le couvercle à boire.	Couvercle déverrouillé.	Vérifiez si le couvercle est correctement verrouillé.

Deutsch

- Wichtige Sicherheitshinweise 74-76
- Vor dem Anschluss 76
- Pflege und Reinigung 77-78
- Teileliste 79-80
- Verwendung Ihres Multi-Zerkleinerers -
Messereinsatz 81-84
 - Benutzungsdiagramme &
Bedienungsanweisungen 81-82
 - Benutzungstabelle 83
 - Rezept 84
- Verwendung Ihres Multi-Zerkleinerers -
Arbeitsscheiben 84-85
 - Benutzungsdiagramme &
Bedienungsanweisungen 84-85
 - Benutzungstabelle 85
- Verwendung Ihres Express Serve 86-87
 - Benutzungsdiagramme &
Bedienungsanweisungen 86
 - Benutzungstabelle 87
- Verwendung Ihres Mini-Mixer/
Kompakt-Zerkleinerers 88-92
 - Benutzungsdiagramme &
Bedienungsanweisungen 88-90
 - Benutzungstabelle 91
 - Rezept 92
- Justierung der Kabellänge 92
- Aufbewahrung 93
- Kundendienst und Service 93-94
- Fehlerbehebung 95-96

Wichtige Sicherheitshinweise



- Lesen Sie diese Anleitungen sorgfältig durch und bewahren Sie sie zur späteren Bezugnahme auf.
- Vor dem ersten Gebrauch die gesamte Verpackung, alles Marketingmaterial und den Kunststoff-Klingenschutz entfernen. Reinigen der Teile: siehe „Pflege und Reinigung“.
- Falls Stecker oder Netzkabel beschädigt sind, müssen sie aus Sicherheitsgründen von Kenwood oder einer autorisierten Kenwood-Kundendienststelle ausgetauscht werden, um Gefahren zu vermeiden.
- **NICHT die scharfen Klingen berühren.** Die Klingen und Arbeitsscheiben sind sehr scharf, bitte vorsichtig handhaben. **Beim Handhaben der scharfen Messer, beim Entleeren der Schüssel und beim Reinigen immer oben am Fingergriff, weg von den Klingen, anfassen.**
- **Die Schüssel des Zerkleinerers und Express Serve sind nicht für die Verarbeitung von Eiswürfeln geeignet.**
- Bevor Sie das Gerät am Deckelgriff heben oder tragen, immer zuerst nachprüfen, dass Schüssel und Deckel sicher verriegelt sind.
- **Keine** heißen Zutaten in den gelieferten Behältern verarbeiten, auch nicht im Mini-Mixer. Heiße Flüssigkeiten können durch plötzliche Dampfbildung aus dem Gerät ausgestoßen werden.
- Das Gerät im Betrieb **niemals** unbeaufsichtigt lassen.
- Das Gerät während des Betriebs **nicht** vom Platz bewegen.
- **Niemals** die in der Empfehlungstabelle angegebenen Höchstmengen überschreiten.
- **Beim Verarbeiten von Teig das Gerät nicht länger als 30 Sekunden laufen lassen, ohne eine Pause von 5 Minuten einzulegen. Bei längerem, ununterbrochenem Betrieb kann Ihr Gerät Schaden nehmen.**
- Vor dem Ausgießen der Schüssel des Zerkleinerers **immer** erst den Messereinsatz und die Scheiben abnehmen.
- Hände und Utensilien nicht in die Schüssel des Zerkleinerers halten, während das Gerät an den Netzstrom angeschlossen ist.
- Wenn Schnittgut in der Schüssel des Zerkleinerers nach unten geschoben werden muss, ein geeignetes Utensil, z. B. einen Spatel, verwenden.
- Schnittgut **niemals** mit den Fingern in den Füllschacht drücken. Stets den mitgelieferten Stopfer verwenden.
- Das Gerät bei Nichtgebrauch und vor dem Zusammensetzen, Auseinandernehmen oder Reinigen **immer** ausschalten und den Netzstecker ziehen.
- VORSICHT: Bevor Sie den Deckel von der Schüssel abnehmen, warten, bis der Aufsatz/die Messer völlig zum Stillstand gekommen ist/sind.
- Schnittgut **nicht** mit zu viel Kraftaufwand in den Füllschacht drücken – Sie könnten das Gerät beschädigen.
- Zum Betreiben des Geräts **niemals** die Deckelverriegelung, sondern immer nur den An-/Aus-Geschwindigkeitsschalter verwenden.
- **Niemals** das Gerät betreiben, wenn sowohl der Messereinsatz als auch eine Arbeitsscheibe eingesetzt sind. Immer nur ein Zubehöerteil verwenden.
- **Das Gerät wird beschädigt und kann Verletzungen verursachen, wenn der Verriegelungsmechanismus mit zu viel Kraftaufwand betätigt wird.**

- **Niemals** nicht zugelassenes Zubehör verwenden.
- **Niemals** ein beschädigtes Gerät benutzen. Lassen Sie es überprüfen oder reparieren: siehe „Kundendienst und Service“.
- Antriebseinheit, Netzkabel und Netzstecker **niemals** nass werden lassen.
- Überschüssiges Netzkabel **nicht** über die Tischkante oder Arbeitsplatte herabhängen oder mit heißen Oberflächen in Berührung kommen lassen.
- Kinder müssen überwacht werden, damit sie nicht mit dem Gerät spielen.
- Dieses Gerät darf nicht von Kindern verwendet werden. Gerät und Netzkabel müssen für Kinder unzugänglich sein.
- Geräte können von Personen mit körperlichen, sensorischen oder geistigen Behinderungen oder von Personen mit mangelnder Erfahrung oder Kenntnis verwendet werden, sofern diese beaufsichtigt oder in die sichere Verwendung des Geräts eingewiesen wurden und sofern sie die damit verbundenen Gefahren verstehen.
- Das Gerät nur für seinen vorgesehenen Zweck im Haushalt verwenden. Kenwood übernimmt keine Haftung bei unsachgemäßer Benutzung des Geräts oder Nichteinhaltung dieser Anleitungen.
- Unsachgemäßer Gebrauch des Geräts kann zu Verletzungen führen.

Express Serve

- Kontakt mit beweglichen Teilen vermeiden. Die Finger nicht in den Schnittgut-Auslass stecken.
- Nur mit eingesetzter Auswurfscheibe betreiben. **Wenn die Auswurfscheibe nicht angebracht ist, sammelt sich das Schnittgut unter der Arbeitsscheibe an und tritt nicht aus dem Auslass aus, was den Aufsatz beschädigen kann.**
- Wenn das Schnittgut nicht aus dem Auslass austritt, ausschalten und überprüfen, dass es sich nicht unter der Arbeitsscheibe angesammelt hat, und dass die Auswurfscheibe montiert ist. Angesammelte Zutaten entfernen und dann die Verarbeitung fortsetzen.
- **Den Express Serve Aufsatz nicht länger als 2 Minuten ununterbrochen betreiben. Zwischen jeder 2-Minuten-Laufzeit 2 Minuten lang abkühlen lassen.**

Mini-Mixer/Kompakt-Zerkleinerer – Sicherheit

-  **KEINE** heißen Zutaten verarbeiten.
-  **KEINE** kohlenensäurehaltigen Flüssigkeiten verarbeiten.
- **VERBRÜHUNGSGEFAHR:** Heiße Zutaten müssen erst auf Zimmertemperatur abkühlen, bevor sie in den Becher gefüllt oder verarbeitet werden.
- Zutaten nicht länger als 24 Stunden im Becher aufbewahren.
- Die Messer sind sehr scharf! Gehen Sie bei Gebrauch und Reinigung **immer** sehr vorsichtig damit um.
- Den Mixer/Zerkleinerer **niemals** leer laufen lassen.
- Smoothie-Rezepte: Niemals gefrorene Zutaten mixen, die beim Tiefkühlen zu einer festen Masse zusammengefroren sind. Die Masse vor dem Einfüllen in den Becher zerkleinern.
- Den Becher nur mit der mitgelieferten Messereinheit verwenden.
- **Niemals** heiße Flüssigkeiten aus dem Becher trinken.

- Beim Trinken aus dem Deckel darauf achten, dass das Getränk dünnflüssig ist. Es braucht vielleicht ein paar Versuche, um das gewünschte Ergebnis zu bekommen, besonders bei der Verarbeitung von festen oder unreifen Zutaten, weil manche davon unverarbeitet bleiben können.
- Gefrorene Zutaten (Eiswürfel ausgenommen) **nicht** ohne Flüssigkeit mixen.
- Niemals gefrorene Früchte oder Gemüsestücke zerkleinern, die größer als 3 x 3 cm sind.
- **Niemals** trockene Zutaten (z. B. Gewürze, Nüsse) mixen oder den Mixer/ Zerkleinerer leer laufen lassen.
- **Niemals** die Messereinheit an der Antriebseinheit anbringen, ohne dass der Becher angebracht ist.
- Vor dem Zerkleinern von Trockenobst, **immer** alle Steine/Kerne entfernen.

Stromverbrauch

- Wenn sich das Gerät nicht in Betrieb befindet
 - Automatische Schaltung auf AUS-Modus: Nicht zutreffend
 - Aus-Modus Stromverbrauch: <0,3 W.



Vor dem Anschluss

- Sicherstellen, dass die Netzspannung mit den Angaben auf der Unterseite des Geräts übereinstimmt.
- Das Gerät entspricht der EG-Verordnung Nr. 1935/2004 über Materialien und Gegenstände, die dazu bestimmt sind, mit Lebensmitteln in Berührung zu kommen.





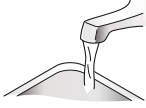
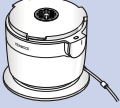





Vor dem ersten Gebrauch

- 1 Den Kunststoff-Klingenschutz abnehmen. Vorsichtig sein, denn die Klingen sind sehr scharf. Diese Abdeckungen sollten entsorgt werden, denn sie dienen lediglich zum Schutz der Klingen bei Herstellung und Transport.
- 2 Die Teile spülen, siehe „Pflege und Reinigung“.

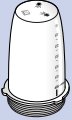
Pflege und Reinigung

			
	X	X	✓
	✓	✓	X
	✓	✓	X
	✓	✓	X
	✓	✓	X
	✓	✓	X
	✓	✓	X
	✓	✓	X
	✓	✓	X

Pflege und Reinigung

			
	X	X	✓
	✓	✓	X
	✓	✓	X
	✓	✓	X
	✓	✓	X
	✓	✓	X
	✓	✓	X

- Ausschalten und warten, bis der Aufsatz/die Messer zum Stillstand kommen. Dann vor dem Reinigen den Netzstecker herausziehen.
- Die Antriebseinheit mit einem feuchten Tuch abwischen und anschließend abtrocknen. Sicherstellen, dass der Verriegelungsbereich frei von Lebensmittelrückständen ist.
- Antriebseinheit nicht in Wasser tauchen.
- Die Messer und Arbeitsscheiben vorsichtig handhaben – sie sind extrem scharf.
- Wenn Sie die Messer des Mini-Mixers/Zerkleinerers von Hand spülen, sollten Sie sie sauberbürsten und unter fließendem Wasser abspülen.

Teilleiste

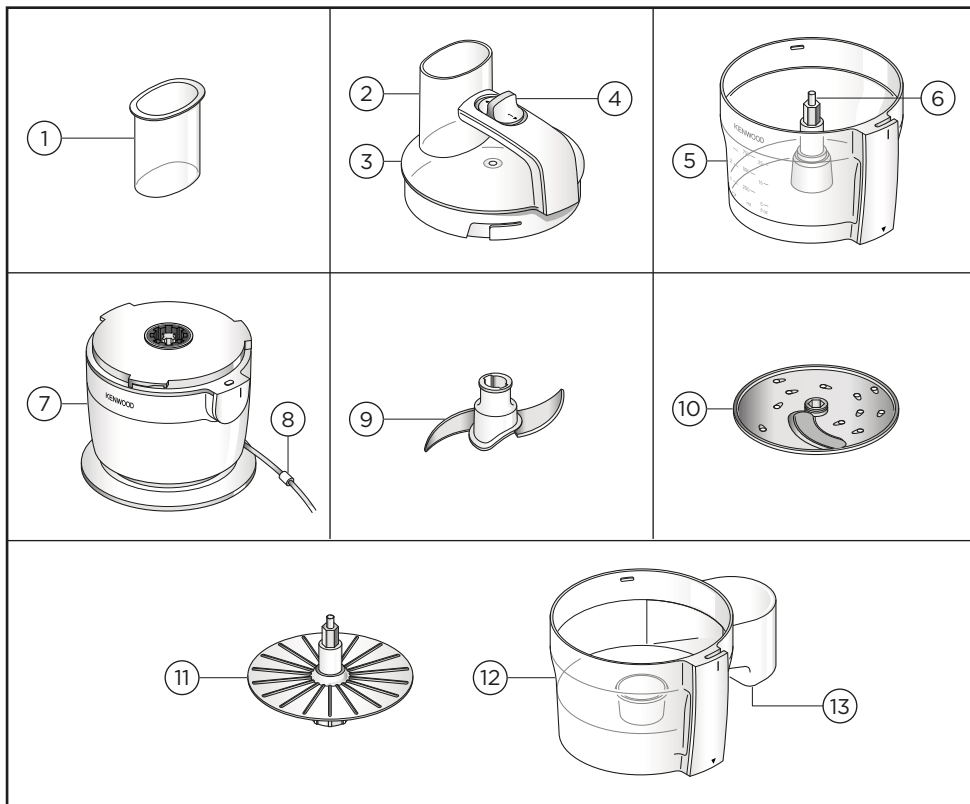

* Falls mitgeliefert

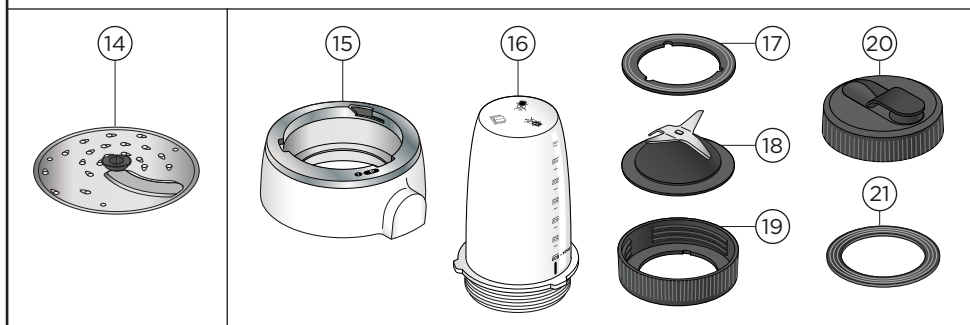

Übersicht

Multi-Zerkleinerer

- ① Stopfer
- ② Füllschacht
- ③ Deckel
- ④ An/Aus-Schalter + Pulsfunktion
- ⑤ Schüssel
- ⑥ Antrieb in der Schüssel
- ⑦ Antriebseinheit
- ⑧ Kabelclip
- ⑨ Schlagmesser
- ⑩ Raspel-/Schneidescheibe, 4 mm

Express Serve

- ⑪ Auswurfscheibe
- ⑫ Express Serve Schüssel
- ⑬ Schnittgutauslass

Disc

- ⑭ Raspel-/Schneidescheibe, 2 mm (wenn im Lieferumfang)

Mini-Mixer/Kompakt-Zerkleinerer

- ⑮ Sockel des Mini-Mixers/Kompakt-Zerkleinerers
- ⑯ Becher
- ⑰ Dichtungsring
- ⑱ Messereinheit
- ⑲ Messerhalter
- ⑳ Trinkdeckel
- ㉑ Trinkdeckel-Dichtungsring

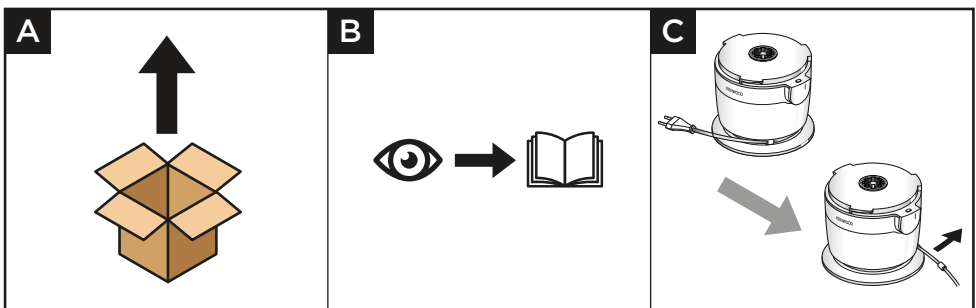

Verwendung Ihres Multi-Zerkleinerers – Messereinsatz

Benutzungsdiagramme & Bedienungsanweisungen

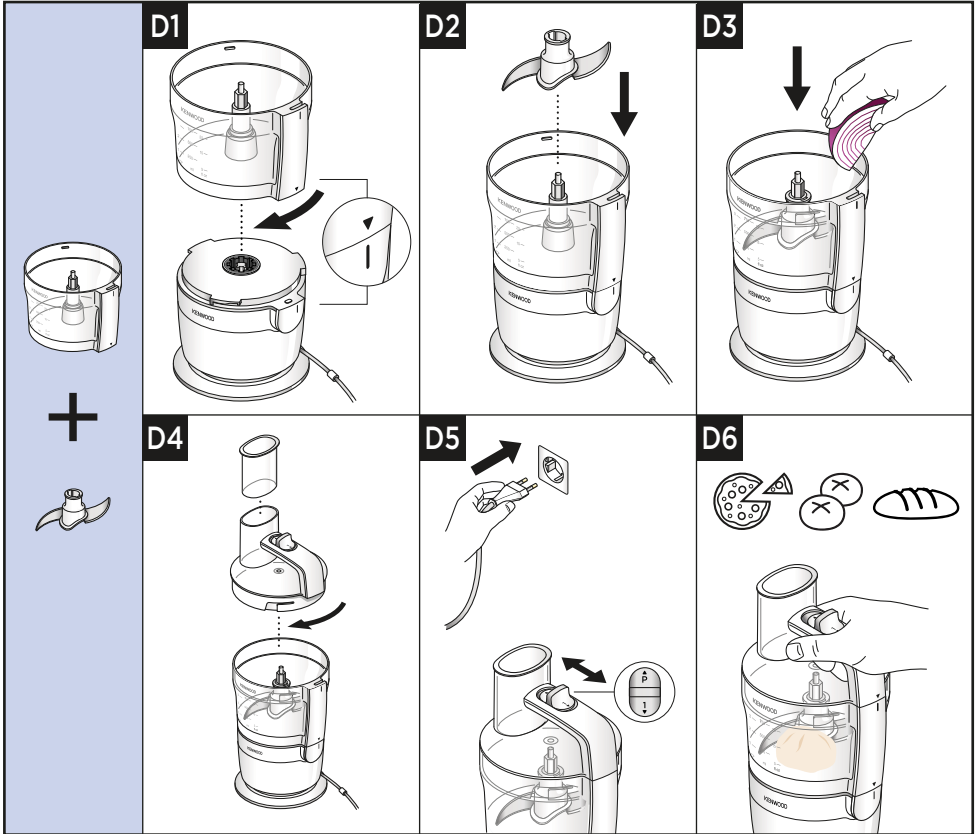

Wichtig





























- Ihr Multi-Zerkleinerer eignet sich nicht zum Zerkleinern oder Mahlen von Kaffeebohnen und Gewürzen, zum Feinmahlen von grobem Zucker oder zur Verarbeitung von Eiswürfeln.
- Beim Hinzufügen von Mandelaroma oder anderen Aromen möglichst vermeiden, dass diese auf den Kunststoff gelangen. Sie könnten zu permanenten Verfärbungen führen.
- Setzen Sie immer die Schüssel und das Zubehörteil auf die Maschine, bevor Sie die Zutaten hinzugeben.
- Nicht den Deckel dazu benutzen, den Mixer zu starten oder zu stoppen.
- Der Multi-Zerkleinerer funktioniert nur, wenn Schüssel und Deckel richtig arretiert sind. Überprüfen Sie, dass sich Einfüllschacht und Schüsselgriff vorne rechts befinden.
- Das Gerät vor dem Abnehmen des Deckels immer ausschalten und den Netzstecker ziehen.
- Brotteig nicht länger als 30 Sekunden verarbeiten.
- Den Brotteig nur von Hand erneut durchkneten. Ein erneutes Kneten in der Schüssel wird nicht empfohlen, da der Multi-Zerkleinerer dabei seinen sicheren Stand verlieren könnte.
- Bei der Verarbeitung von Teig das Gerät immer am Griff festhalten.

- 1 Die Schüssel auf die Antriebseinheit aufsetzen und sie durch Drehen im Uhrzeigersinn einrasten.
- 2 Den Messereinsatz auf die Antriebswelle aufsetzen.
- 3 Die Zutaten in die Schüssel des Zerkleinerers geben.
- 4 Den Deckel aufsetzen.
- 5 Das Gerät einstöpseln.
- 6 Das Gerät einschalten oder die Pulsfunktion verwenden.

Hinweise und Tipps

- Verwenden Sie die Pulsfunktion (P) für kurze, stoßweise Mixvorgänge. Die Pulsfunktion läuft, solange der Schalter in der entsprechenden Position gehalten wird.
- Manche Zutaten können den Kunststoff verfärben. Dies ist völlig normal und hat keine Auswirkungen auf den Kunststoff oder den Geschmack der Zutaten. Mit einem in Pflanzenöl getauchten Tuch abreiben, um die Verfärbungen zu beseitigen.
- **Brotteig** – Zuerst die trockenen Zutaten in die Schüssel geben, dann die Flüssigkeit hinzugeben. Verarbeiten, bis eine geschmeidige Teigkugel entsteht.
- Das Gerät am Deckelgriff festhalten, falls es beginnen sollte, sich auf der Arbeitsfläche zu bewegen.
- Für ein gröberes Ergebnis empfiehlt sich die Pulsfunktion.
- Ein zu langes Verarbeiten vermeiden.
- Beim Zubereiten von Teig das Fett direkt aus dem Kühlschrank in ca. 2 cm großen Stücken zugeben.

Benutzungstabelle

E	 MAX (g)	 (Sek.)
 	20-30	10-20
	200	30
	150	20-30
 	300	10/P
 	200	P
 	250	15-20
 	100-200	20
	400	60
	x3  + 300 ml 	45-60
	250 g  + 150 g 	30
	250 g 	10-30
	 x3 +  150 g +  150 g +  18-22° C +  150 g	20

Rezept

Pflaumenmarinade

400 g Honig

40 g Trockenpflaumen

50 ml Wasser

- 1 Über Nacht in den Kühlschrank stellen.
- 2 Mit der Pulsfunktion 4 Sekunden lang verarbeiten.

Verwendung Ihres Multi-Zerkleinerers - Arbeitsscheiben

Benutzungsdiagramme & Bedienungsanweisungen

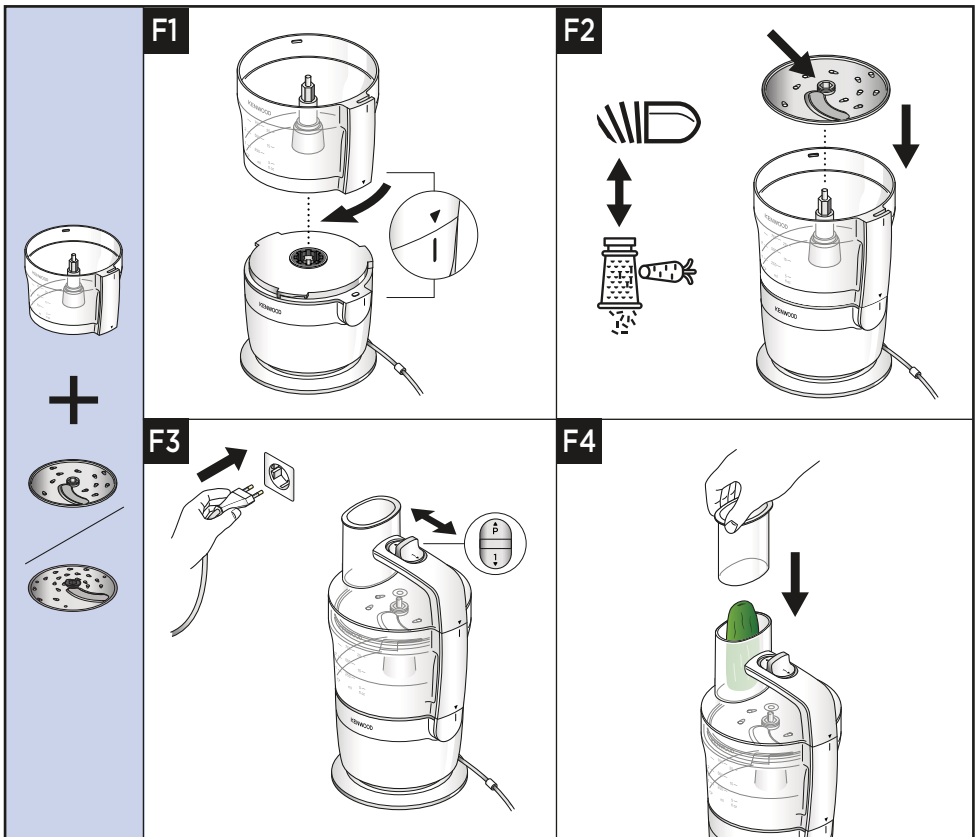

Wichtig











- Stecken Sie niemals die Finger in den Füllschacht.

- 1 Die Schüssel auf die Antriebseinheit aufsetzen und sie durch Drehen im Uhrzeigersinn einrasten.
- 2 Halten Sie die Scheibe am Mittelgriff fest und setzen Sie sie mit der gewünschten Seite nach oben auf die Antriebswelle.
- 3 Setzen Sie den Deckel auf.
- 4 Die Zutaten in den Füllschacht geben.
- 5 Einstöpseln, auf Stufe 1 schalten und sie mit dem Stopfer gleichmäßig runterdrücken.

Hinweise und Tipps

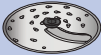
- Frische Zutaten verwenden.
- Die Zutaten nicht zu klein schneiden. Die Breite des Füllschachts ausfüllen (aber nicht zu eng hineinstopfen). Dies verhindert, dass Zutaten beim Verarbeiten seitlich wegrutschen.
- Beim Schneiden oder Raspeln: Senkrecht eingefülltes Schnittgut wird kürzer geschnitten als horizontal liegende Stücke.
- Nach der Verarbeitung bleiben immer kleine Reste auf der Scheibe oder in der Schüssel zurück.

Benutzungstabelle

G 	 MAX (g)	 (Sek.)
	750 ml 	10-20
	750 ml 	10-20
	 MAX (g)	 (Sek.)
	750 ml 	10-20

Verwendung Ihres Express Serve

Benutzungsdiagramme & Bedienungsanweisungen

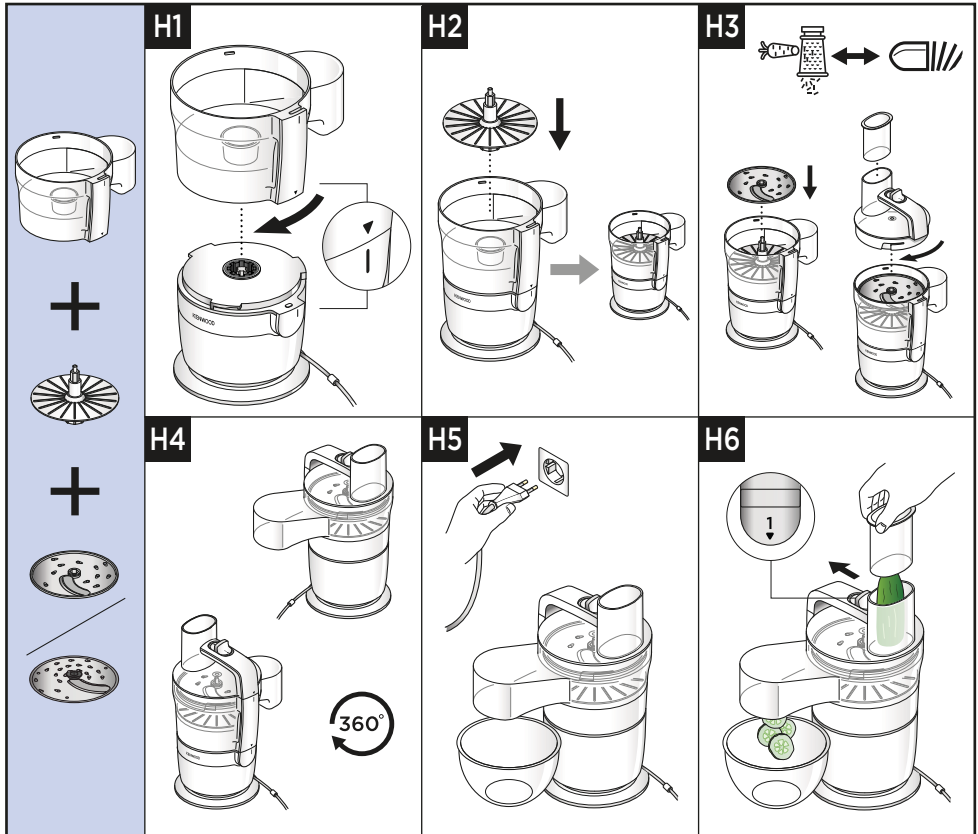













Wichtig

- Bei der Benutzung des Aufsatzes keine übermäßige Kraft aufwenden.
- Wenn das Schnittgut nicht aus dem Auslass austritt, ausschalten und überprüfen, dass es sich nicht unter der Arbeitsscheibe angesammelt hat, und dass die Auswurfscheibe angebracht ist. Festgesetzte Zutaten lösen und dann die Verarbeitung fortsetzen.

- 1 Die Schüssel auf die Antriebseinheit aufsetzen und sie durch Drehen im Uhrzeigersinn einrasten.
- 2 Die Auswurfscheibe und die gewünschte Arbeitsscheibe anbringen.
- 3 Den Deckel anbringen.
- 4 Die Zutaten in den Füllschacht geben.
- 5 Einstöpseln, auf Stufe 1 schalten und sie mit dem Stopfer gleichmäßig runterdrücken.

Benutzungstabelle

	 MAX (g)	 (Sek.)
		120
		120
	 MAX (g)	 (Sek.)
		120

Verwendung Ihres Mini-Mixer/Kompakt-Zerkleinerers

Benutzungsdiagramme & Bedienungsanweisungen



J1

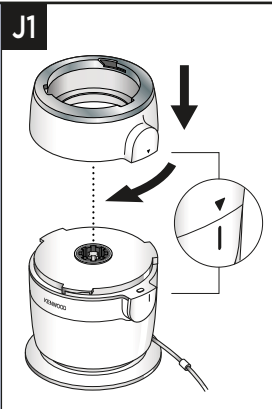

J2

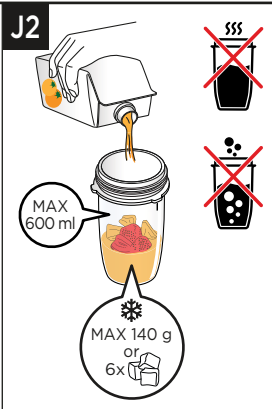

J3

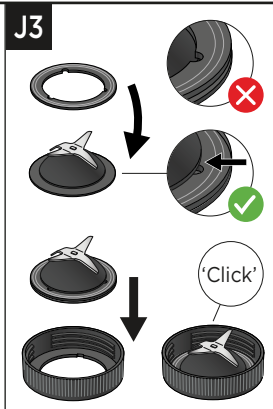

J4



J5



J6

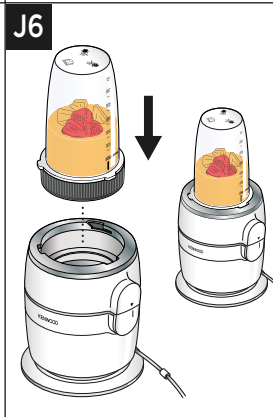

J7

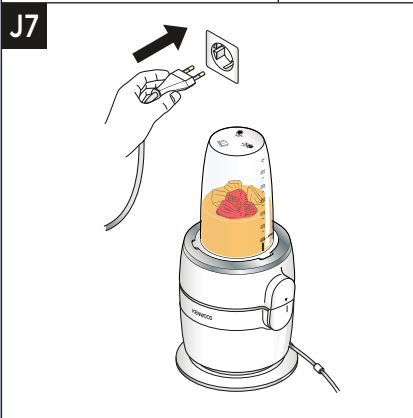

J8

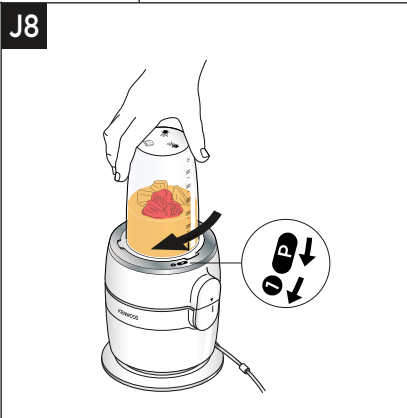

Verwendung Ihres Mini-Mixer/Kompakt-Zerkleinerers

Benutzungsdiagramme & Bedienungsanweisungen

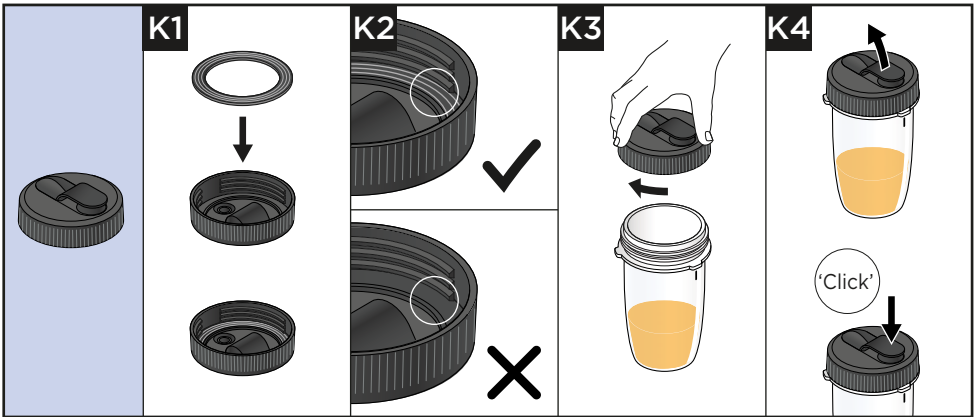

Wichtig

- Bevor der Mini-Mixer/Kompakt-Zerkleinerer aufgesetzt wird, muss zunächst der Sockel des Mini-Mixers/Kompakt-Zerkleinerers angebracht werden.
- Gefrorene Zutaten (Eiswürfel ausgenommen) nicht ohne Flüssigkeit mixen.
- Wenn der Dichtungsring beschädigt oder inkorrekt angebracht ist, wird Flüssigkeit austreten.
- Niemals gefrorene Zutaten mixen, die beim Tiefkühlen zu einer festen Masse zusammengefroren sind.
- Niemals gefrorene Früchte oder Gemüsestücke zerkleinern, die größer als 3 x 3 cm sind.
- Für beste Mixergebnisse Eis oder gefrorene Zutaten immer zuerst in den Becher geben.
- Vor dem Zerkleinern von Trockenobst, **immer** alle Steine/Kerne entfernen.

- 1 Den Mini-Mixer/Kompakt-Zerkleinerer auf die Antriebseinheit aufsetzen und durch Drehen im Uhrzeigersinn einrasten.
- 2 Zutaten bis zur 600-ml-Markierung in den Becher füllen.
- 3 Den Dichtungsring am Messereinsatz anbringen, dabei sicherstellen, dass die Dichtung korrekt auf dem gerillten Bereich aufsitzt.
- 4 Den Messereinsatz vorsichtig in den Klingenhalter einsetzen und an ihm festklipsen.
- 5 Den zusammengesetzten Klingenhalter an seiner Unterseite packen und mit den Klängen nach unten auf den Becher aufsetzen.
- 6 Den zusammengesetzten Klingenhalter auf den Becher aufschrauben und durch Drehen im Uhrzeigersinn einrasten.
- 7 Schütteln, um die Zutaten gut zu vermischen.
- 8 Den Aufsatz auf die Antriebseinheit aufsetzen.
- 9 Einstöpseln. Um die Pulsfunktion zu wählen, den Aufsatz im Uhrzeigersinn (zu P) drehen und loslassen. Für Dauergeschwindigkeit den Aufsatz im Uhrzeigersinn (zu 1) drehen, bis er einrastet.











Trinkdeckel

- 10 Den Dichtungsring in den Trinkdeckel einlegen. Darauf achten, dass die Dichtung korrekt im gerillten Bereich zu liegen kommt.
- 11 Zum Benutzen des Trinkdeckels den zusammengesetzten Klingenhalter vom Becher abschrauben. Den Trinkdeckel durch Drehen im Uhrzeigersinn befestigen.
- 12 Zum Trinken öffnen Sie einfach den Klappverschluss. Das Getränk kann direkt aus der Flasche getrunken werden.
- 13 Nach dem Trinken den Klappverschluss schließen. Fest zudrücken.

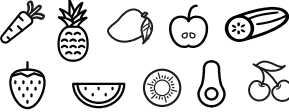
Hinweise und Tipps

- Bitte beachten: Wenn der Becher bis zur Maximalkapazität (600 ml) gefüllt ist, enthält er ca. zwei Portionen.
- Wenn das Getränk nicht zum sofortigen Verzehr gedacht ist, bitte in den Kühlschrank stellen und innerhalb von 24 Stunden konsumieren.
- Achten Sie darauf, dass Ihr Getränk ausreichend dünnflüssig ist, damit es aus dem Ausgussdeckel getrunken werden kann. Um das Getränk dünnflüssiger zu machen, einfach mehr Flüssigkeit hinzugeben.
- Es kann sein, dass nach dem Mixen manche Getränke nicht richtig dünnflüssig sind. Dies liegt an Samen- oder Faserbestandteilen mancher Zutaten.
- Bei manchen Getränken können sich feste Bestandteile nach einer Zeit absetzen. Deshalb ist es das Beste, diese sofort zu trinken. Getränke mit Satz sollten vor dem Trinken aufgerührt werden.
- Den Becher immer aufrecht halten, wenn der Trinkdeckel angebracht ist..

Benutzungstabelle

L		 MAX (g)		 (Sek.)
	 3 cm	600 ml	1	30-60
	100 g	10-20	P	
	X 6 120-140 g	P	10-20	
	50 g	P	10-20	
	100 g	1	30-60	
	50 g	P	10	

Rezept

Pesto

60 g frisches Basilikum
1 Knoblauchzehe
25 g Pinienkerne
25 g geriebener Parmesan
110 g Olivenöl
Salz nach Geschmack
Pfeffer nach Geschmack

- 1 Alle Zutaten in den Becher des Mixers/Zerkleinerers geben. Die Pulstaste für 5 Schübe herunterdrücken, dann so lange mit kontinuierlicher Geschwindigkeit verarbeiten, bis (nach ca. 25 Sekunden) die gewünschte Konsistenz erreicht ist.

Trockenpflaumen-Marinade

300 g Honig
40 g Trockenpflaumen
70 ml Wasser

- 1 Alle Zutaten in den Becher des Mixers/Zerkleinerers geben. Über Nacht in den Kühlschrank stellen. (Zutaten nicht länger als 24 Stunden im Becher aufbewahren.)
- 2 Mit der Pulsfunktion 4 Sekunden lang verarbeiten. Sofort verwenden.

Justierung der Kabellänge

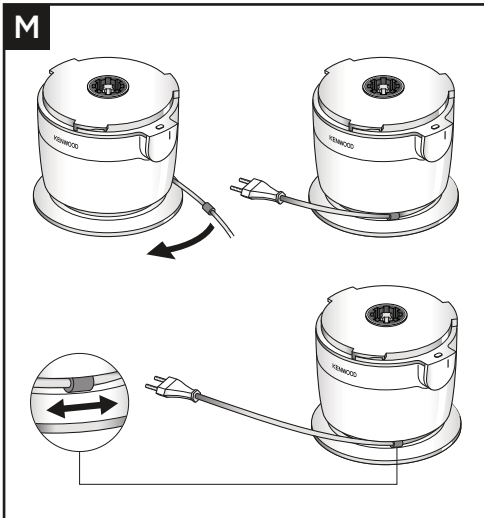

- Das Kabel auf die gewünschte Länge unten um das Gerät wickeln und mit dem Kabelclip festklemmen.

Aufbewahrung

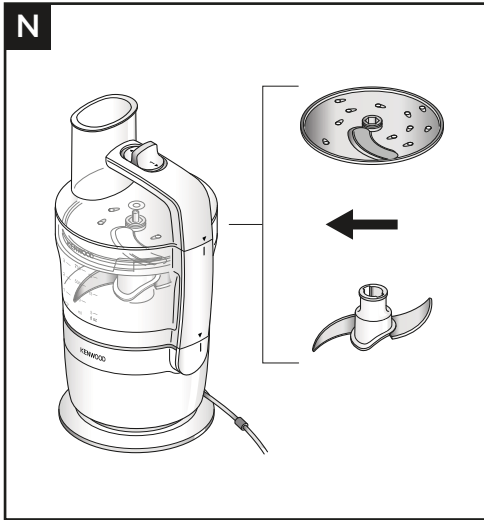

- Der Messereinsatz und eine Arbeitsscheibe können nach Gebrauch zusammen in der Schüssel verstaut werden.
- Die zweite Scheibe (falls mitgeliefert) kann in der Express Serve-Schüssel verstaut werden.
- Niemals das Gerät betreiben, wenn Messereinsatz und Arbeitsscheibe gleichzeitig angebracht sind. Immer jeweils nur ein einziges Zubehörteil verwenden.

Kundendienst und Service

- Sollten Sie irgendwelche Probleme mit dem Betrieb Ihres Geräts haben, ziehen Sie bitte den Abschnitt „Fehlerbehebung“ zu Rate oder besuchen Sie www.kenwoodworld.com, bevor Sie Hilfe anfordern.
- Bitte beachten Sie, dass Ihr Produkt durch eine Garantie abgedeckt ist – diese erfüllt alle gesetzlichen Anforderungen hinsichtlich geltender Garantie- und Verbraucherrechte in dem Land, in dem das Produkt gekauft wurde.
- Falls Ihr Kenwood-Produkt nicht ordnungsgemäß funktioniert oder Defekte aufweist, bringen Sie es bitte zu einem autorisierten KENWOOD Servicecenter oder senden Sie es ein. Aktuelle Informationen zu autorisierten KENWOOD Servicecentern in Ihrer Nähe finden Sie bei www.kenwoodworld.com bzw. auf der Website für Ihr Land.
- Gestaltet und entwickelt von Kenwood GB.
- Hergestellt in China.

Aktualisierte Informationen zur Entsorgung von Altgeräten

Das Elektro- und Elektronikgerätegesetz (ElektroG) enthält eine Vielzahl von Anforderungen an den Umgang mit Elektro und Elektronikgeräten. Die wichtigsten sind hier zusammengestellt.

1. Getrennte Erfassung von Altgeräten

Elektro- und Elektronikgeräte, die zu Abfall geworden sind, werden als Altgeräte bezeichnet. Besitzer von Altgeräten haben diese einer vom unsortierten Siedlungsabfall getrennten Erfassung zuzuführen. Altgeräte gehören insbesondere nicht in den Hausmüll, sondern in spezielle Sammel- und Rückgabesysteme.

2. Batterien und Akkus sowie Lampen

Besitzer von Altgeräten haben Altbatterien und Altakkumulatoren, die nicht vom Altgerät umschlossen sind, sowie Lampen, die zerstörungsfrei aus dem Altgerät entnommen werden können, im Regelfall vor der Abgabe an einer Erfassungsstelle vom Altgerät zu trennen. Dies gilt nicht, soweit Altgeräte einer Vorbereitung zur Wiederverwendung unter Beteiligung eines öffentlich-rechtlichen Entsorgungsträgers zugeführt werden.

3. Möglichkeiten der Rückgabe von Altgeräten

Besitzer von Altgeräten aus privaten Haushalten können diese bei den Sammelstellen der öffentlich-rechtlichen Entsorgungsträger oder bei den von Herstellern oder Vertreibern im Sinne des ElektroG eingerichteten Rücknahmestellen unentgeltlich abgeben.

Rücknahmepflichtig sind Geschäfte mit einer Verkaufsfläche von mindestens 400 m² für Elektro- und Elektronikgeräte sowie diejenigen Lebensmittelgeschäfte mit einer Gesamtverkaufsfläche von mindestens 800 m², die mehrmals pro Jahr oder dauerhaft Elektro- und Elektronikgeräte anbieten und auf dem Markt bereitstellen. Dies gilt auch bei Vertrieb unter Verwendung von Fernkommunikationsmitteln, wenn die Lager- und Versandflächen für Elektro- und Elektronikgeräte mindestens 400 m² betragen oder die gesamten Lager- und Versandflächen mindestens 800 m² betragen. Vertreter haben die Rücknahme grundsätzlich durch geeignete Rückgabemöglichkeiten in zumutbarer Entfernung zum jeweiligen Endnutzer zu gewährleisten.

Die Möglichkeit der unentgeltlichen Rückgabe eines Altgerätes besteht bei rücknahmepflichtigen Vertreibern unter anderem dann, wenn ein neues gleichartiges Gerät, das im Wesentlichen die gleichen Funktionen erfüllt, an einen Endnutzer abgegeben wird. Wenn ein neues Gerät an einen privaten Haushalt ausgeliefert wird, kann das gleichartige Altgerät auch dort zur unentgeltlichen Abholung übergeben werden; dies gilt bei einem Vertrieb unter Verwendung von Fernkommunikationsmitteln für Geräte der Kategorien 1, 2 oder 4 gemäß § 2 Abs. 1 ElektroG, nämlich „Wärmeüberträger“, „Bildschirmgeräte“ oder „Großgeräte“ (letztere mit mindestens einer äußeren Abmessung über 50 Zentimeter). Zu einer entsprechenden Rückgabe-Absicht werden Endnutzer beim Abschluss eines Kaufvertrages befragt. Außerdem besteht die Möglichkeit der unentgeltlichen Rückgabe bei Sammelstellen der Vertreter unabhängig vom Kauf eines neuen Gerätes für solche Altgeräte, die in keiner äußeren Abmessung größer als 25 Zentimeter sind, und zwar beschränkt auf drei Altgeräte pro Geräteart.

4. Datenschutz-Hinweis

Altgeräte enthalten häufig sensible personenbezogene Daten. Dies gilt insbesondere für Geräte der Informations- und Telekommunikationstechnik wie Computer und Smartphones. Bitte beachten Sie in Ihrem eigenen Interesse, dass für die Löschung der Daten auf den zu entsorgenden Altgeräten jeder Endnutzer selbst verantwortlich ist.

5. Bedeutung des Symbols „durchgestrichene Mülltonne“



Das auf Elektro- und Elektronikgeräten regelmäßig abgebildete Symbol einer durchgestrichenen Mülltonne weist darauf hin, dass das jeweilige Gerät am Ende seiner Lebensdauer getrennt vom unsortierten Siedlungsabfall zu erfassen ist.

Fehlerbehebung

Problem	Ursache	Lösung
Der Multi-Zerkleinerer funktioniert nicht.	Kein Strom.	Prüfen, ob der Stecker des Multi-Zerkleinerers in der Steckdose steckt.
	Schüssel nicht richtig auf Antriebseinheit angebracht.	Der Multi-Zerkleinerer wird nicht funktionieren, wenn die Schüssel oder der Deckel nicht korrekt angebracht sind.
	Schüsseldeckel nicht korrekt verriegelt.	Prüfen, ob Schüssel und Deckel aufeinander ausgerichtet und korrekt verriegelt sind.
Multi-Zerkleinerer bleibt während der Arbeit stehen.	Maschine überlastet / Höchstmengen überschritten.	Höchstmengen in der Empfehlungstabelle prüfen.
	Deckel nicht verriegelt.	Prüfen, ob der Deckel richtig verriegelt ist.
Schüssel lässt sich nicht mit aufgesetztem Deckel auf das Unterteil aufsetzen.	Der An/Aus-Schalter steht auf „An“.	Den Schalter auf „Aus“ stellen.
Schnittgut tritt nicht aus dem Auslass des Express Serve aus.	Die Auswurfscheibe ist nicht unter der Rassel-/ Schneidescheibe angebracht.	Die Auswurfscheibe einsetzen.
Geschnittene oder geraspelte Zutaten vom Schlagmesser beschädigt.	Wird betrieben, während Schlagmesser und Arbeitsscheibe gleichzeitig in der Schüssel angebracht sind.	Das Schlagmesser herausnehmen, bevor Sie die Rassel-/ Schneidescheibe verwenden.
Gerät instabil / starke Vibration und Bewegung.	Teig zu lange geknetet.	Das Gerät am Deckelgriff festhalten, falls es beginnen sollte, sich auf der Arbeitsfläche zu bewegen. Teig nicht länger als 30 Sekunden verarbeiten und die in der Verwendungstabelle empfohlene Höchstmenge nicht überschreiten.
	Maschine überlastet / Höchstmengen überschritten.	
	Teig nachgeknetet.	Nur von Hand nachkneten. Das Nachkneten in der Schüssel wird nicht empfohlen, da der Multi-Zerkleinerer dabei ihren sicheren Stand verlieren könnte.
	Es werden klebrige Früchte/ Zutaten, z. B. Datteln, verarbeitet.	Für beste Ergebnisse die Zutaten zunächst mit der Pulsfunktion grob zerkleinern und erst dann zum Dauerbetrieb übergehen.

Fehlerbehebung

Problem	Ursache	Lösung
Starkes Spritzen oder Zutaten werden aus dem Füllschacht ausgestoßen.	Stopfer nicht eingesetzt.	Bei der Verarbeitung von Teig, Gebäck- und Kuchenmischungen immer den Stopfer einsetzen, damit nichts aus dem Füllschacht herausspritzt.
Schwache Leistung des Schlagmessers und der Arbeitsscheibe.	Sehen Sie den Abschnitt „Hinweise und Tipps“, und befolgen Sie die in der Nutzungstabelle gegebenen Empfehlungen.	
Mini-Mixer/Kompakt-Zerkleinerer funktioniert nicht.	Mini-Mixer/Kompakt-Zerkleinerer nicht richtig eingerastet. Der Sockel des Mini-Mixers/ Kompakt-Zerkleinerers ist nicht richtig eingerastet.	Mini-Mixer/Kompakt-Zerkleinerer funktioniert nicht, wenn er nicht korrekt an der Verriegelung angebracht wurde.
Beim Mini-Mixer/ Kompakt-Zerkleinerer tritt Flüssigkeit aus dem Sockel der Messereinheit aus.	Dichtung fehlt. Dichtung falsch eingesetzt. Dichtung beschädigt. Klingenhalter nicht vollständig/korrekt festgezogen.	Prüfen, ob der Klingenhalter fest aufgeschraubt ist. Prüfen, ob die Dichtung korrekt in die Rille eingesetzt wurde (wie in Diagramm J3 gezeigt) und nicht beschädigt ist. Für Informationen zum Kauf einer Ersatzdichtung siehe „Kundendienst und Service“.
Der Trinkdeckel des Mini-Mixers/ Zerkleinerer leckt.	Deckel nicht verschlossen.	Prüfen, ob Deckel richtig eingerastet ist.

Italiano

- Informazioni importanti sulla sicurezza 98-100
- Prima di collegare l'apparecchio alla rete elettrica 100
- Cura e pulizia 101-102
- Elenco delle parti 103-104
- Come utilizzare il Food Processor - Lama del coltello 105-109
 - Diagrammi di utilizzo e istruzioni per l'uso 105-107
 - Tabella per l'utilizzo 108
 - Ricetta 109
- Come utilizzare il Food Processor - Dischi 109-110
 - Diagrammi di utilizzo e istruzioni per l'uso 109-110
 - Tabella per l'utilizzo 110
- Come utilizzare Express Serve 111-112
 - Diagrammi di utilizzo e istruzioni per l'uso 111-112
 - Tabella per l'utilizzo 112
- Come utilizzare il frullatore/tritatutto personale 113-117
 - Diagrammi di utilizzo e istruzioni per l'uso 113-115
 - Tabella per l'utilizzo 116
 - Ricetta 117
- Regolazione cavo 117
- Immagazzinaggio 118
- Manutenzione e assistenza tecnica 119
- Guida alla risoluzione dei problemi 120-121

Informazioni importanti sulla sicurezza



- Leggere attentamente le presenti istruzioni e conservarle come futuro riferimento.
- Prima dell'uso, rimuovere tutto l'imballaggio, il materiale pubblicitario e le protezioni in plastica delle lame. Lavare le parti: vedere la sezione 'Cura e pulizia'.
- Se la spina o il cavo sono danneggiati, per motivi di sicurezza, devono essere sostituiti da Kenwood o da un riparatore autorizzato da Kenwood per evitare pericoli.
- **NON toccare le lame affilate.** Le lame e i dischi sono molto affilati, maneggiare con cura. **Tenere sempre dalla presa per le dita in alto, lontano dal bordo tagliente, quando si maneggiano le lame affilate, si svuota il contenitore e durante la pulizia.**
- **La ciotola del Food Processor e la funzione Express non sono adatte alla lavorazione dei cubetti di ghiaccio.**
- Prima di sollevare o trasportare l'apparecchio con la maniglia sul coperchio, controllare sempre che la ciotola e il coperchio siano saldamente bloccati in posizione.
- **Non** lavorare ingredienti caldi in nessuno dei contenitori in dotazione, compreso il frullatore personale. I liquidi caldi potrebbero fuoriuscire dall'apparecchio a causa dell'improvviso vapore.
- **Non** lasciare mai l'apparecchio incustodito dopo averlo acceso.
- **Non** muovere l'apparecchio durante il funzionamento.
- **Non** superare le capacità massime indicate nella tabella di utilizzo consigliata.
- **Non utilizzare l'apparecchio per più di 30 secondi quando si lavora l'impasto senza un periodo di riposo di 5 minuti. L'uso continuato per periodi più lunghi può danneggiare l'apparecchio.**
- Rimuovere **sempre** la lama e i dischi prima di versare il contenuto dalla ciotola del Food Processor.
- Tenere le mani e gli utensili lontani dalla ciotola del Food Processor quando è collegato all'alimentazione elettrica.
- Se è necessario spingere il cibo nella ciotola del Food Processor, utilizzare un utensile adatto, come una spatola.
- **Non** usare mai le dita per spingere gli alimenti nel tubo di riempimento. Utilizzare sempre lo spingitore in dotazione.
- Spegnerne **sempre** l'apparecchio e scollegarlo dall'alimentazione se lasciato incustodito e prima del montaggio, smontaggio o pulizia.
- **ATTENZIONE:** Prima di rimuovere il coperchio dalla ciotola attendere che l'attacco/lame si sia completamente fermato.
- **Non** esercitare una forza eccessiva per spingere il cibo lungo il tubo di riempimento, poiché si potrebbe danneggiare l'apparecchio.
- **Non** usare il blocco del coperchio per azionare il Food Processor, usare sempre il comando della velocità on/off.
- **Non** azionare il Food Processor con la lama e il disco inseriti contemporaneamente. Utilizzare un solo accessorio alla volta.
- **Questo apparecchio può venire danneggiato e provocare un infortunio se si esercita forza eccessiva sul suo meccanismo di blocco.**
- Non utilizzare l'apparecchio con accessori non autorizzati.

- Non usare mai un apparecchio danneggiato. Farlo controllare o riparare: vedere la sezione 'Manutenzione e assistenza tecnica'.
- Non bagnare il motore, il cavo o la spina.
- Non lasciar pendere il cavo elettrico dal piano di lavoro e non lasciare che tocchi superfici calde.
- Sorvegliare i bambini, assicurandosi che non giochino con l'apparecchio.
- Questo apparecchio non dev'essere utilizzato dai bambini. Tenere apparecchio e cavo lontani dalla portata dei bambini.
- Gli apparecchi possono essere utilizzati da persone con ridotte capacità psicofisico-sensoriali, o con esperienza e conoscenze insufficienti solo nel caso in cui siano state attentamente sorvegliate e istruite da un responsabile su come utilizzare un apparecchio in modo sicuro e siano consapevoli dei pericoli.
- Utilizzare l'apparecchio solo per l'uso domestico per cui è stato realizzato. Kenwood non si assumerà nessuna responsabilità se l'apparecchio verrà utilizzato in modo improprio o senza seguire le presenti istruzioni.
- L'uso improprio dell'apparecchio può causare lesioni.

Express Serve

- Evitare il contatto con parti in movimento. Tenere le dita fuori dall'apertura di uscita del cibo.
- Non far funzionare senza la piastra di supporto montata. **Se la piastra di supporto non è installata, il cibo si intaserà sotto la piastra e non uscirà dall'uscita del cibo, con conseguenti danni all'apparecchio.**
- Se il cibo non fuoriesce dall'uscita del cibo, spegnere e controllare che il cibo non sia intasato sotto il disco e che la piastra di Express Serve sia montata. Rimuovere qualsiasi cibo intrappolato prima di continuare la lavorazione.
- **Non far funzionare l'accessorio Express Serve in modo continuo per più di 2 minuti. Lasciare raffreddare per 2 minuti tra ogni operazione di 2 minuti.**

Sicurezza del frullatore/tritatutto personale

-  **NON** lavorare ingredienti caldi.
-  **NON** frullare liquidi gassati.
- **PERICOLO DI SCOTTATURA:** gli ingredienti caldi devono essere lasciati raffreddare a temperatura ambiente prima di essere inseriti nel bicchiere o prima di essere frullati.
- Non conservare gli ingredienti nella tazza per più di 24 ore.
- Fare **sempre** attenzione nel maneggiare le lame. Evitare di toccare il filo di taglio della lama durante la pulizia.
- **Non** azionare mai il frullatore/tritatutto a vuoto.
- Ricette di frullati: non frullare mai ingredienti congelati che hanno formato una massa solida durante il congelamento, ma spezzettarli prima di aggiungerli al bicchiere.
- Utilizzare solo il bicchiere con il gruppo lame in dotazione.
- **Non** bere mai liquidi caldi dal bicchiere.
- Al momento di bere dal coperchio, assicurarsi che la bevanda sia ben frullata. È necessario fare qualche prova per ottenere i risultati desiderati, particolarmente quando si frullano ingredienti duri o acerbi, che potrebbero non venire lavorati a sufficienza.

- **Non** frullare ingredienti congelati senza liquidi (ad eccezione dei cubetti di ghiaccio).
- **Non** frullare mai pezzi di frutta o verdura congelati che siano più grandi di 3 cm x 3 cm.
- **Non** frullare mai ingredienti secchi (ad es. spezie, noci) né azionare il frullatore/tritatutto a vuoto.
- **Non** montare **mai** il gruppo lame sull'unità motore senza il bicchiere inserito.
- **Rimuovere sempre** i noccioli dalla frutta secca prima di tagliarla.

Consumo energetico

- Quando l'apparecchio non è in funzione
 - Commutazione automatica in modalità OFF: Non applicabile
 - Alimentazione in modalità Off: $\leq 0,3$ W.



Prima di collegare l'apparecchio alla rete elettrica

- Assicurarsi che la tensione della vostra rete elettrica sia la stessa di quella indicata sulla targhetta sotto l'apparecchio.
- Questo apparecchio è conforme al regolamento (CE) No. 1935/2004 sui materiali e articoli in contatto con alimenti.







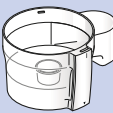



Prima di usare l'apparecchio per la prima volta

- 1 Rimuovere il coprilama in plastica dalla lama del coltello. Prestare attenzione perché le lame sono molto affilate. Questo coprilama deve essere gettato poiché serve solo a proteggere la lama durante la produzione e il trasporto.
- 2 Lavare le parti come indicato nella sezione "Cura e pulizia".

Cura e pulizia

			
	X	X	✓
	✓	✓	X
	✓	✓	X
	✓	✓	X
	✓	✓	X
	✓	✓	X
	✓	✓	X
	✓	✓	X
	✓	✓	X

Cura e pulizia

			
	X	X	✓
	✓	✓	X
	✓	✓	X
	✓	✓	X
	✓	✓	X
	✓	✓	X
	✓	✓	X

- Spegnere, attendere che l'accessorio/le lame si arrestino e scollegare prima di effettuare la pulizia.
- Pulire l'unità di alimentazione con un panno umido, poi asciugarla. Assicurarsi che l'area di interblocco sia libera da residui di cibo.
- Non immergere in acqua il corpo motore.
- Maneggiare con cura le lame e i dischi da taglio: sono estremamente affilati.
- Se si lavano a mano le lame del frullatore/tritatutto personale, è necessario spazzolarle e risciacquarle sotto l'acqua corrente.

Elenco delle parti

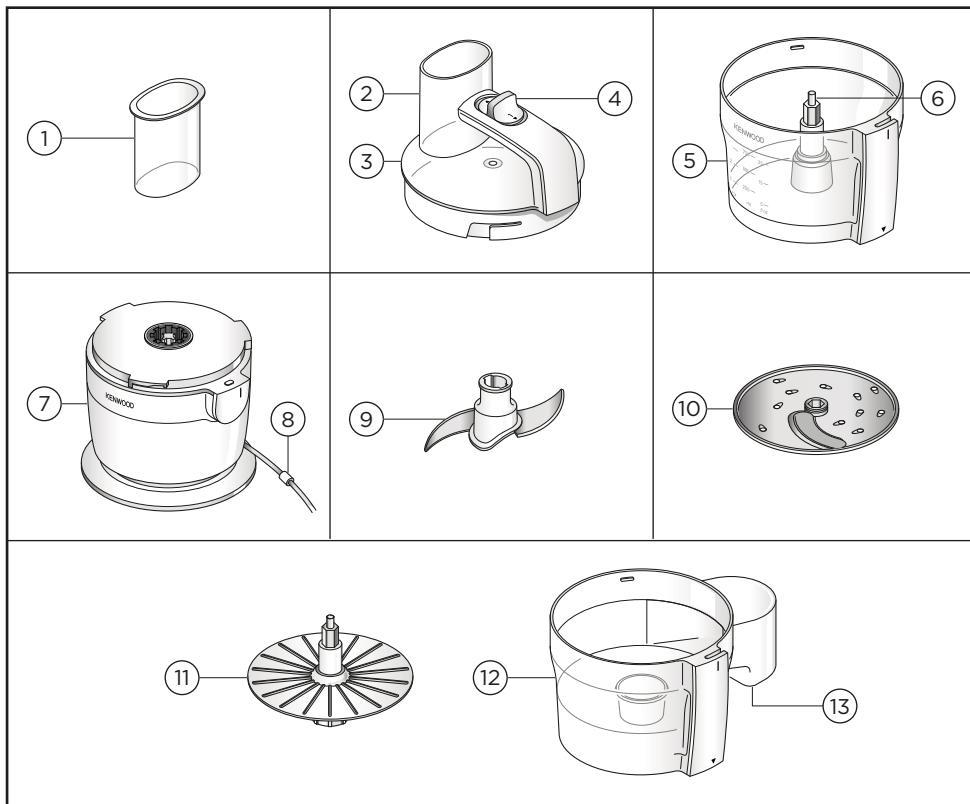

* Se fornito

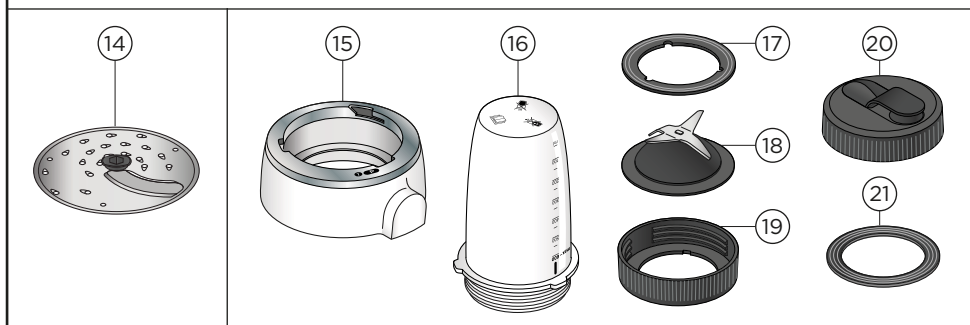

Legenda

Food Processor

- ① Spingitori
- ② Tubo di riempimento
- ③ Coperchio
- ④ Interruttore acceso/spento + Pulse (Impulsi)
- ⑤ Ciotola
- ⑥ Unità In-Bowl (Sistema in-Bowl Drive)
- ⑦ Corpo motore
- ⑧ Fermacavo
- ⑨ Lama
- ⑩ Disco per affettare/grattugiare da 4 mm

Express Serve

- ⑪ Disco slinger
- ⑫ Uscita cibo
- ⑬ Ciotola Express Serve™

Disco

- ⑭ Disco per affettare/grattugiare da 2 mm (se in dotazione)

Frullatore/tritatutto personale

- ⑮ Base frullatore/tritatutto personale
- ⑯ Bicchiere
- ⑰ Anello di tenuta
- ⑱ Unità lama
- ⑲ Supporto lama
- ⑳ Coperchio con beccuccio
- ㉑ Anello di tenuta coperchio con beccuccio

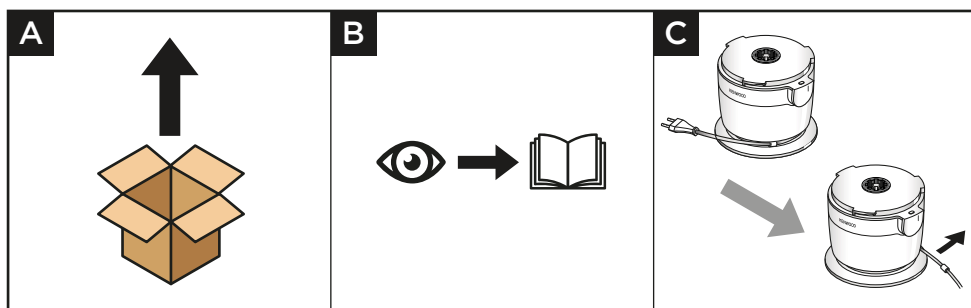

Come utilizzare il Food Processor - Lama del coltello

Diagrammi di utilizzo e istruzioni per l'uso

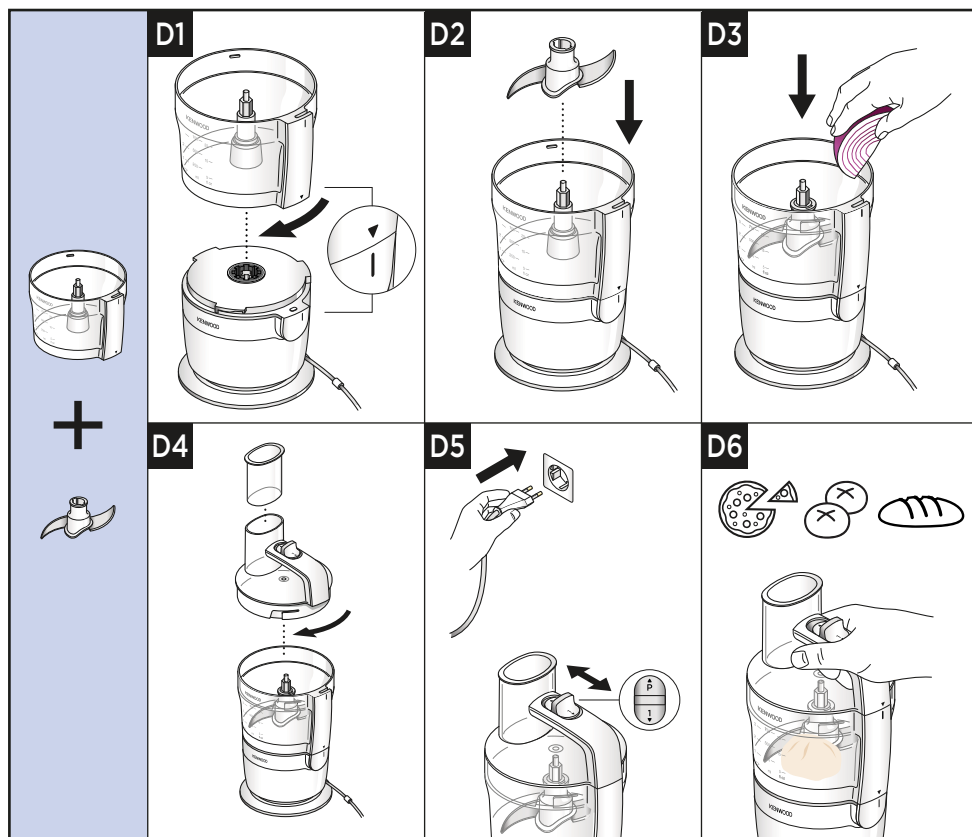

Importante



























- Il Food Processor non è adatto per tritare o macinare chicchi di caffè e spezie, trasformare lo zucchero semolato in zucchero a velo o frantumare cubetti di ghiaccio.
- Durante l'aggiunta di aromi o essenza di mandorle, evitare il contatto diretto con la plastica in quanto può provocare macchie permanenti.
- Prima di aggiungere gli ingredienti, assicurarsi sempre di montare la ciotola e l'accessorio sul Food Processor.
- Non utilizzare il coperchio per azionare il Food Processor.
- Il robot non funziona se la ciotola o il coperchio non sono montati correttamente sul dispositivo di sicurezza. Assicurarsi che il tubo di riempimento e la maniglia della ciotola si trovino sulla destra.
- Spegnere l'apparecchio ed estrarre sempre la spina dalla presa elettrica prima di togliere il coperchio.
- Impasto di pane, non lavorare per più di 30 secondi.
- Impastare nuovamente l'impasto del pane solo a mano. Si sconsiglia di re-impastare nella ciotola per evitare che il Food Processor diventi instabile.
- Tenere sempre l'unità per la maniglia durante la lavorazione dell'impasto.

- 1 Inserire la ciotola nell'unità di alimentazione e ruotare in senso orario per bloccarla.
- 2 Inserire la lama del coltello sull'albero motore.
- 3 Aggiungere gli ingredienti nella ciotola del Food Processor.
- 4 Chiudere il coperchio.
- 5 Collegare l'unità alla rete elettrica.
- 6 Accendere l'unità o utilizzare la funzione Pulse.

Suggerimenti e consigli

- Per lavorare ad intermittenza gli ingredienti, utilizzare il tasto impulsi (P). L'apparecchio continua a funzionare fino a quando il tasto rimane premuto.
- Alcuni alimenti potrebbero scolorire la plastica. Questo è perfettamente normale e non danneggia la plastica né influisce sul sapore del vostro cibo. Strofinare con un panno immerso in olio vegetale per rimuovere lo scolorimento.
- **Impasto per pane** - Versare prima gli ingredienti secchi nella ciotola e poi aggiungere il liquido. Lavorare fino a formare una palla di pasta liscia ed elastica.
- Se l'apparecchio inizia a muoversi sul piano di lavoro, usare la maniglia sul coperchio per sostenerlo.
- Per consistenze meno omogenee utilizzare il comando a impulsi.
- Non esagerare con la lavorazione.
- Nel preparare dolci, utilizzare burro appena tolto dal frigorifero, tagliato in cubetti da 2 cm pollici.

Tabella per l'utilizzo

E	MAX (g)	L (sec)
 	20-30	10-20
	200	30
	150	20-30
 	300	10/P
 	200	P
 	250	15-20
 	100-200	20
	400	60
	x3  + 300 ml 	45-60
	250 g  + 150 g 	30
	250 g 	10-30
	 x3 +  150 g +  150 g ^{18-22°C}  +  150 g	20

Recetta

Marinata di prugne

400 g miele

40 g prugne

50 ml acqua

- 1 Conservare in frigorifero per una notte.
- 2 Lavorare per 4 secondi con Pulse (Impulsi).

Come utilizzare il Food Processor - Dischi

Diagrammi di utilizzo e istruzioni per l'uso

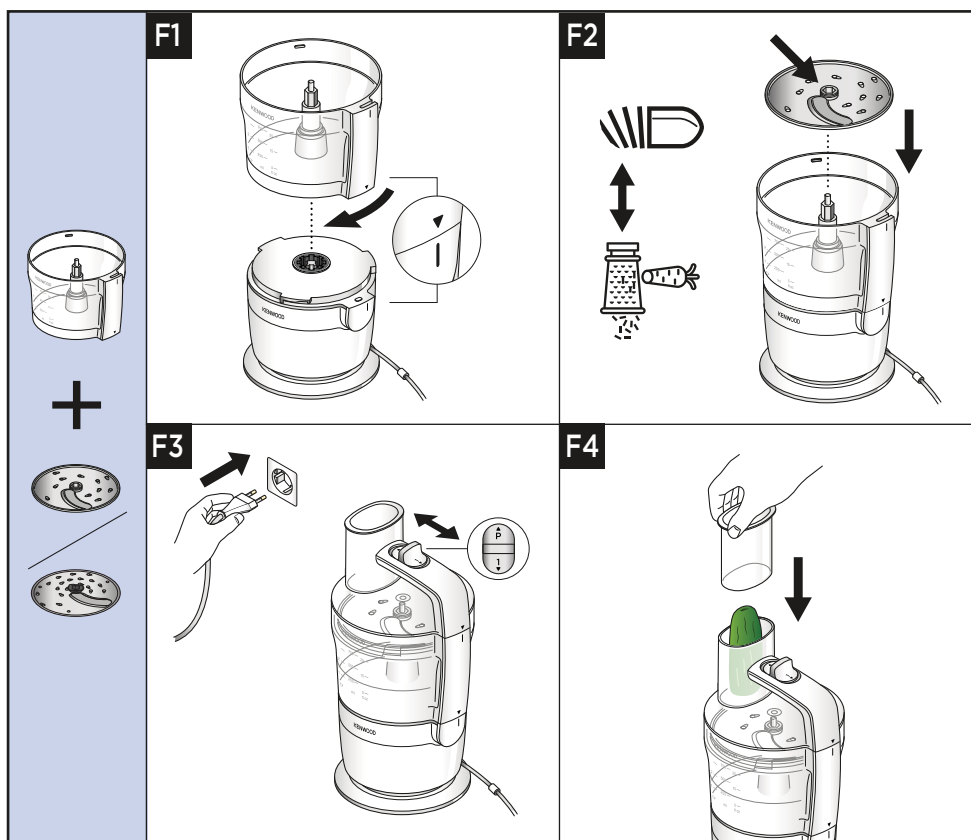

Importante











- Non infilare mai le dita nel tubo di riempimento.

- 1 Inserire la ciotola sull'unità di alimentazione e ruotare in senso orario per bloccarla.
- 2 Tenendolo per la presa centrale, inserire il disco sull'alberino di rotazione con il lato appropriato rivolto verso l'alto.
- 3 Inserire il coperchio.
- 4 Inserire il cibo nel tubo di alimentazione.
- 5 Collegare l'apparecchio, impostare la velocità 1 e spingere verso il basso in modo uniforme con lo spingitore.

Suggerimenti e consigli

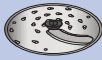
- Usare ingredienti freschi.
- Non tagliare gli alimenti in pezzi troppo piccoli. Riempire il tubo di alimentazione con gli ingredienti (evitando di riempirlo eccessivamente), in modo da impedire che gli alimenti scivolino lateralmente durante la lavorazione.
- Nell'affettare o grattugiare: gli alimenti inseriti in verticale saranno tagliati in pezzi più corti di quelli inseriti in orizzontale.
- Dopo la lavorazione, rimarrà sempre un certo quantitativo di residui sul disco o nella vaschetta.

Tabella per l'utilizzo

G 	 MAX (g)	 (sec)
	750 ml 	10-20
	750 ml 	10-20
	 MAX (g)	 (sec)
	750 ml 	10-20

Come utilizzare Express Serve

Diagrammi di utilizzo e istruzioni per l'uso

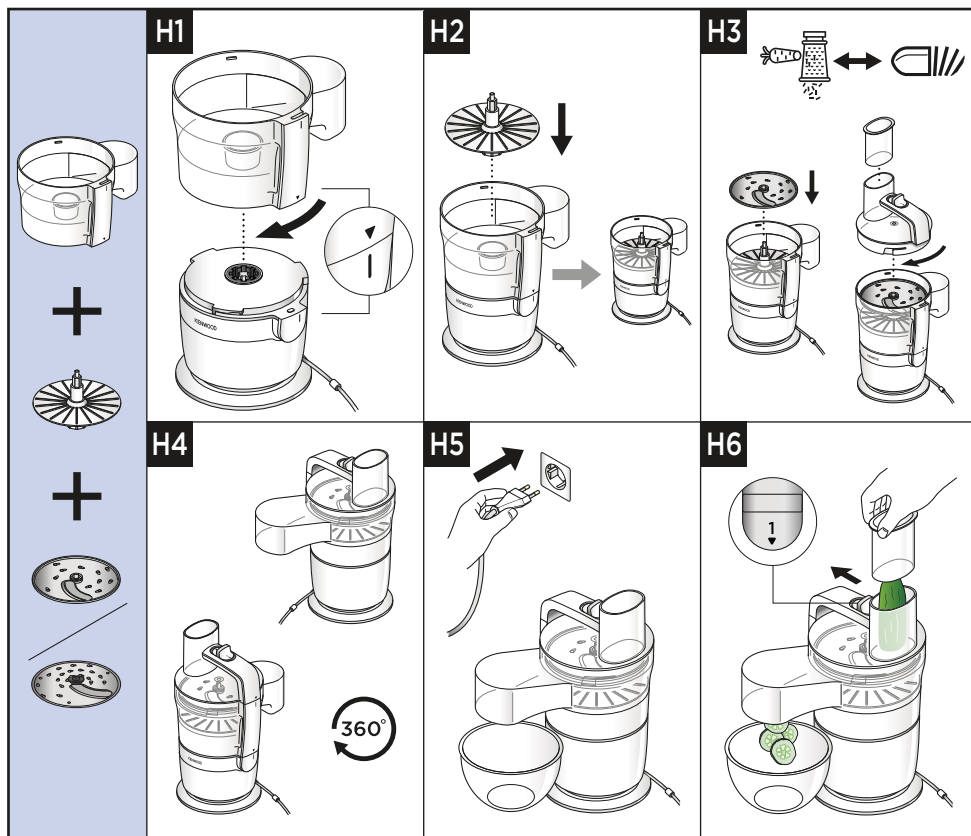











Importante

- Non applicare una forza eccessiva quando si utilizza l'accessorio.
- Se il cibo non fuoriesce dall'uscita del cibo, spegnere e controllare che il cibo non si sia intasato sotto il disco e che il disco slinger sia montato. Eliminare eventuali residui di cibo prima di continuare la lavorazione.

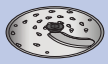
- 1 Inserire la ciotola sull'unità motore e ruotare in senso orario per bloccarla.
- 2 Inserire la piastra slinger e il disco richiesto.
- 3 Installare il coperchio.
- 4 Inserire il cibo nel tubo di alimentazione.
- 5 Collegare l'apparecchio, impostare la velocità 1 e spingere verso il basso in modo uniforme con lo spingitore.

Tabella per l'utilizzo

I 	 MAX (g)	 (sec)
		120
		120
	 MAX (g)	 (sec)
		120

Come utilizzare il frullatore/tritatutto personale

Diagrammi di utilizzo e istruzioni per l'uso

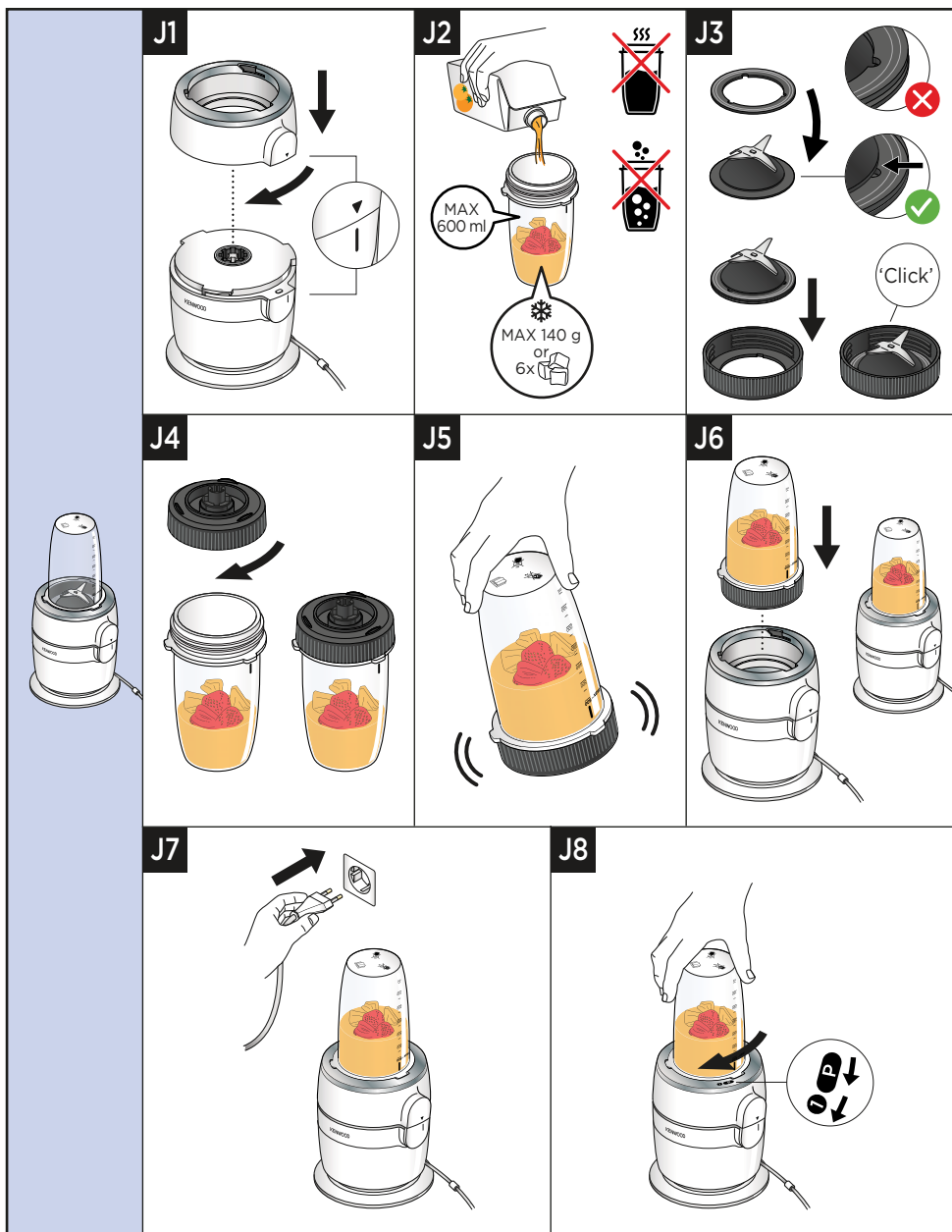

Come utilizzare il frullatore/tritatutto personale

Diagrammi di utilizzo e istruzioni per l'uso

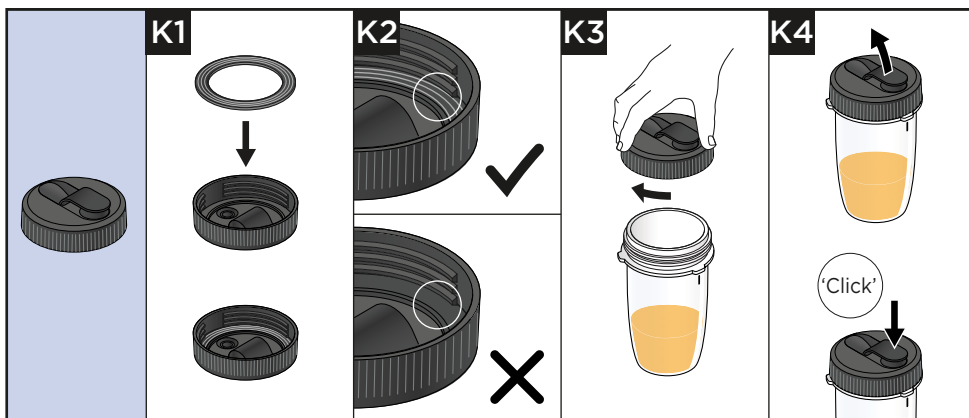

Importante

- La base del frullatore/tritatutto personale deve essere montata sull'unità di alimentazione prima di montare il frullatore/tritatutto personale.
- Non frullare ingredienti congelati senza liquidi (ad eccezione dei cubetti di ghiaccio).
- Si verificano delle perdite se l'anello di tenuta è danneggiato o montato in modo errato.
- Non frullare mai ingredienti congelati che hanno formato una massa solida.
- Non frullare mai pezzi di frutta o verdura congelati che siano più grandi di 3 cm x 3 cm.
- Per ottenere risultati ottimali, aggiungere sempre prima il ghiaccio/gli ingredienti congelati nella bottiglia.
- **Rimuovere sempre** i noccioli dalla frutta secca prima di tagliarla.

- 1 Inserire la base del frullatore/tritatutto personale sull'unità di alimentazione, ruotare in senso orario per bloccare.
- 2 Aggiungere gli ingredienti nella tazza fino al segno di livello 600 ml.
- 3 Inserire l'anello di tenuta sull'unità lama, assicurandosi che la guarnizione sia fissata correttamente nella zona scanalata.
- 4 Abbassare con cautela il gruppo lama nel supporto lama e fissarlo in posizione con la clip.
- 5 Tenere la parte inferiore del supporto lama assemblato e abbassarlo sulla tazza, con le lame rivolte verso il basso.
- 6 Avvitare il supporto lama assemblato sulla tazza, ruotando in senso orario per bloccarlo.
- 7 Agitare per distribuire gli ingredienti.
- 8 Abbassare l'accessorio sull'unità motrice.
- 9 Collegare alla presa. Per selezionare la velocità a impulsi, ruotare in senso orario (verso P) e rilasciare l'accessorio. Per selezionare la velocità continua, ruotare l'accessorio in senso orario (verso 1) fino a quando non si blocca in posizione.











Coperchio con beccuccio

- 10 Inserire l'anello di tenuta sul coperchio con beccuccio, assicurandosi che la guarnizione sia fissata correttamente nella zona scanalata.
- 11 Per utilizzare il coperchio con beccuccio, svitare il supporto della lama assemblato dalla tazza. Inserire il coperchio con beccuccio ruotandolo in senso orario.
- 12 Quando si desidera bere, è sufficiente aprire il coperchio. La bevanda può essere consumata direttamente dalla bottiglia.
- 13 Dopo aver bevuto, riposizionare il coperchio. Premere con decisione per fissarlo.

Suggerimenti e consigli

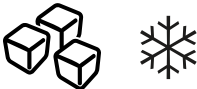
- Si noti che quando il bicchiere è riempito al massimo della sua capacità (600 ml), ciò corrisponde approssimativamente a due porzioni.
- Se non si intende consumare subito la bevanda, conservarla in frigorifero e consumarla entro 24 ore.
- Accertarsi che la bevanda sia abbastanza liquida da poterla bere dal coperchio erogatore. Per avere una bevanda più diluita, aggiungere più liquido.
- Dopo aver frullato gli ingredienti, la consistenza potrebbe non essere perfetta a causa della presenza di semi o di frutti fibrosi.
- Alcune bevande possono separarsi se non vengono consumate subito, quindi è meglio berle immediatamente. Le bevande separate vanno mescolate prima di berle.
- Quando il coperchio con beccuccio è montato, tenere sempre la tazza in posizione verticale.

Tabella per l'utilizzo

L		 MAX (g)		 (sec)
	 3 cm	600 ml	1	30-60
		100 g	10-20	P
		X 6 120-140 g	P	10-20
		50 g	P	10-20
		100 g	1	30-60
		50 g	P	10

Recetta

Pesto

60 g di basilico fresco
1 spicchio d'aglio
25 g di pinoli
25 g di parmigiano grattugiato
110 g di olio d'oliva
Sale q.b.
Pepe

- 1 Versare tutti gli ingredienti nel frullatore/tritatutto. Frullare 5 volte, quindi continuare a frullare fino a ottenere la consistenza desiderata (circa 25 secondi).

Marinata di prugne secche

300 g di miele
40 g di prugne secche
70 ml di acqua

- 1 Versare tutti gli ingredienti nel bicchiere del frullatore/tritatutto. Conservare in frigorifero per una notte. (Non conservare gli ingredienti nella tazza per più di 24 ore.).
- 2 Frullare per 4 secondi utilizzando la funzione Pulse. Usare immediatamente.

Regolazione cavo

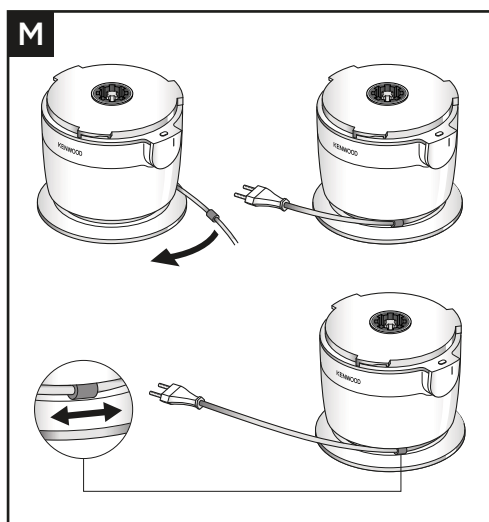

- Avvolgere il cavo intorno alla base del Food Processor fino alla lunghezza desiderata e agganciare il cavo usando il fermacorda.

Immagazzinaggio

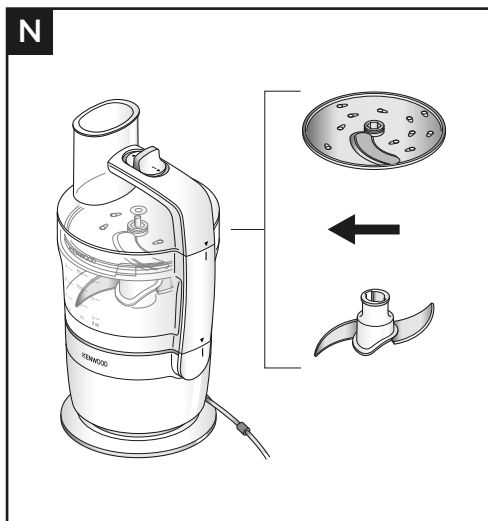

- Dopo l'uso, la lama del coltello e un disco possono essere riposti insieme nella ciotola.
- Il secondo disco (se in dotazione) può essere riposto nella ciotola per servire rapidamente.
- Non azionare il Food Processor con la lama del coltello e un disco inseriti. Utilizzare un solo accessorio alla volta.

Manutenzione e assistenza tecnica

- In caso di qualsiasi problema relativo al funzionamento dell'apparecchio, prima di contattare il servizio assistenza si consiglia di consultare la sezione "Guida alla risoluzione problemi", o di visitare il sito www.kenwoodworld.com.
- NB L'apparecchio è coperto da garanzia, nel rispetto di tutte le disposizioni di legge relative a garanzie preesistenti e ai diritti dei consumatori vigenti nel Paese ove l'apparecchio è stato acquistato.
- In caso di guasto o cattivo funzionamento di un apparecchio Kenwood, si prega di inviare o consegnare di persona l'apparecchio a uno dei centri assistenza KENWOOD. Per individuare il centro assistenza KENWOOD più vicino, visitare il sito www.kenwoodworld.com o il sito specifico del Paese di residenza.
- Disegnato e progettato da Kenwood nel Regno Unito.
- Prodotto in Cina.



IMPORTANTI AVVERTENZE PER IL CORRETTO SMALTIMENTO DEL PRODOTTO AI SENSI DELLA DIRETTIVA EUROPEA SUI RIFIUTI DI APPARECCHIATURE ELETTRICHE ED ELETTRONICHE (RAEE)

Alla fine della sua vita utile il prodotto non deve essere smaltito insieme ai rifiuti urbani. Deve essere consegnato presso gli appositi centri di raccolta differenziata predisposti dalle amministrazioni comunali, oppure presso i rivenditori che offrono questo servizio.

Guida alla risoluzione dei problemi

Problema	Causa	Soluzione
Il Food Processor non funziona.	Manca la corrente.	Controllare che la spina dell'apparecchio sia inserita nella presa elettrica.
	Ciotola non inserita correttamente sul corpo motore.	Il Food Processor non funziona se la ciotola o il coperchio non sono inseriti correttamente nell'interblocco.
	Coperchio della ciotola inserito male.	Controllare che la ciotola e il coperchio siano allineati e incastrati correttamente.
Il Food Processor si ferma durante l'uso.	Sovraccarico/superamento delle capacità massime del Food Processor.	Controllare le capacità massime nel "Grafico di utilizzo consigliato".
	Il coperchio non è ben chiuso.	Controllare che il coperchio sia bloccato correttamente.
Non è possibile montare la ciotola sulla base con il coperchio montato.	L'interruttore On/Off è in posizione 'On' (accesso).	Muovere l'interruttore in posizione "off" (spento).
Cibo che non esce dall'uscita dell'accessorio Express Serve.	La piastra di supporto non è montata sotto la griglia/disco di affettatura.	Installare la piastra di supporto.
Affettare o grattugiare il cibo danneggiato dalla lama del coltello.	Funzionamento con la lama del coltello e il disco montato nella ciotola.	Rimuovere la lama del coltello prima di usare il disco per grattugiare/affettare.
Unità instabile/ vibrazioni pesanti e movimento.	L'impasto è stato lavorato per troppo tempo.	Se l'apparecchio inizia a muoversi sul piano di lavoro, usare la maniglia sul coperchio per sostenerlo. Non lavorare gli impasti per più di 30 secondi e non superare la quantità massima raccomandata nella tabella di utilizzo.
	Sovraccarico/superamento delle capacità massime del Food Processor.	
	L'impasto è stato nuovamente impastato.	Impastare nuovamente solo a mano. Si sconsiglia di impastare nuovamente nella ciotola perché potrebbe rendere instabile il Food Processor.
	Si stanno lavorando frutti/ingredienti appiccicosi come, ad esempio, i datteri.	Per i migliori risultati, usare prima "Pulse" (Impulsi) per disgregare gli ingredienti e quindi il funzionamento continuo.

Guida alla risoluzione dei problemi

Problema	Causa	Soluzione
Tanti spruzzi o ingredienti espulsi dal tubo di riempimento.	Spingitore non montato.	Montare sempre lo spingitore quando si lavora la pasta, gli impasti per pasticceria e i dolci per evitare schizzi dal tubo di riempimento.
Scarse prestazioni della lama del coltello e del disco.	Consultare la sezione Consigli e suggerimenti e seguire le raccomandazioni della tabella di utilizzo.	
Il frullatore/tritatutto personale non funziona.	Frullatore/tritatutto personale non bloccato correttamente Base del frullatore/tritatutto personale non bloccata correttamente	Il frullatore/tritatutto personale non funzionerà se non è correttamente inserito nel dispositivo di blocco.
Il frullatore/tritatutto personale perde dalla base del gruppo della lama.	Manca la tenuta. La tenuta è inserita male. La tenuta è danneggiata. Il portalame non è serrato completamente o correttamente.	Controllare che il portalame sia completamente avvitato. Controllare che la guarnizione sia inserita correttamente nella scanalatura come da schema J3 e non sia danneggiata. Per ottenere una tenuta di ricambio, vedere la sezione "Manutenzione e assistenza tecnica".
Il frullatore personale/tritatutto perde dal coperchio.	Coperchio sbloccato.	Controllare che il coperchio sia ben chiuso.

Português

- Informação de Segurança Importante 123-125
- Antes de ligar à corrente 125
- Cuidados e limpeza 126-127
- Lista de Componentes 128-129
- Para Usar o Seu Processador de Alimentos -
Unidade de Lâminas 130-132
 - Utilização dos Diagramas e Instruções 130-131
 - Quadro de Utilização 132
 - Receita 132
- Para Usar o Seu Processador de Alimentos -
Discos 133-134
 - Utilização dos Diagramas e Instruções 133-134
 - Quadro de Utilização 134
- Para Usar o Seu Express Serve 135-136
 - Utilização dos Diagramas e Instruções 135-136
 - Quadro de Utilização 136
- Para Usar o Seu Liquidificador/
Picador Pessoal 137-141
 - Utilização dos Diagramas e Instruções 137-139
 - Quadro de Utilização 140
 - Receita 141
- Ajustar o cabo eléctrico 141
- Armazenamento 142
- Assistência e Cuidados ao Cliente 143
- Guia de avarias 144-145

Informação de Segurança Importante



- Leia atentamente estas instruções e guarde-as para consulta futura.
- Antes de utilizar pela primeira vez, retire todas as embalagens, literatura de marketing e plástico das tampas das lâminas. Lave os componentes: ver “Cuidados e limpeza”.
- Se a ficha ou o cabo eléctrico estiver danificado, por razões de segurança deve ser substituído pela Kenwood ou por um reparador Kenwood autorizado para evitar qualquer perigo.
- **NÃO toque nas lâminas afiadas.** As lâminas e os discos estão muito afiados, manipule com cuidado. **Segure sempre pela pega superior afastando-se do gume, quando manusear as lâminas afiadas, quando esvaziar a taça e quando limpar.**
- **A taça e o Express Serve do processador de alimentos não devem ser utilizados para processar cubos de gelo.**
- Antes de levantar ou transportar o aparelho pela pega da tampa, confirme sempre que a taça e a tampa estão bem presas.
- **Não** processe ingredientes quentes em nenhum dos recipientes fornecidos, incluindo o liquidificador pessoal. Líquidos quentes podem ser lançados para fora do aparelho devido a formação súbita de vapor.
- **Nunca** deixe o aparelho sem vigilância quando estiver em funcionamento.
- **Não** mova o aparelho enquanto estiver a funcionar.
- **Não** exceda as capacidades máximas mencionadas no quadro de utilização recomendada.
- **Não faça funcionar o seu aparelho durante mais do que 30 segundos quando processar massa para pão sem intercalar um período de descanso de 5 minutos. Processar continuamente durante longos períodos pode danificar o seu aparelho.**
- Retire **sempre** a unidade de lâmina e os discos antes de servir o conteúdo da taça do processador de alimentos.
- Mantenha as mãos e utensílios afastados da taça do processador de alimentos enquanto estiver ligado à corrente eléctrica.
- Se os alimentos precisarem de ser empurrados para baixo dentro da taça do processador de alimentos, utilize um utensílio apropriado como uma espátula.
- **Nunca** utilize os dedos para empurrar os alimentos no tubo de alimentação. Utilize sempre o empurrador fornecido.
- Desligue e retire da tomada eléctrica o aparelho **sempre** que não estiver a vigiá-lo e antes de montar, desmontar ou limpar.
- **ATENÇÃO:** Antes de retirar a tampa da taça espere até que as lâminas parem completamente.
- **Não** empurre os alimentos pelo tubo de alimentação, com demasiada força, porque pode estragar o seu aparelho.
- **Não** utilize o bloqueio da tampa para operar o processador, utilize sempre os botões de controlo de velocidade on/off.
- **Não** utilize a unidade de lâmina e um disco em simultâneo quando usa o processador. Use apenas um acessório de cada vez.
- **Este aparelho ficará danificado e poderá provocar ferimentos se o mecanismo de engate for submetido a uma força excessiva.**
- **Não** utilize acessórios não autorizados.

- **Nunca** utilize um acessório danificado. Mande-a examinar ou reparar: ver “Assistência e cuidados do cliente”.
- **Não** deixe que a unidade motriz, o cabo ou a ficha fiquem molhados.
- **Não** deixe que o cabo fique pendurado ao longo da extremidade de uma mesa ou bancada ou entre em contacto com superfícies quentes.
- As crianças devem ser vigiadas para garantir que não brincam com o electrodoméstico.
- Este electrodoméstico não pode ser usado por crianças. Mantenha o electrodoméstico e o respectivo fio eléctrico fora do alcance de crianças.
- Os electrodomésticos podem ser utilizados por pessoas com capacidades mentais, sensoriais ou físicas reduzidas, ou com falta de experiência ou conhecimento, se forem supervisionadas ou instruídas sobre o uso do electrodoméstico de forma segura e se compreenderem os riscos envolvidos.
- Use o aparelho apenas para o fim doméstico a que se destina. A Kenwood não se responsabiliza caso o aparelho seja utilizado de forma inadequada, ou caso estas instruções não sejam respeitadas.
- O uso inapropriado do seu aparelho pode resultar em ferimentos.

Express Serve

- Evite o contacto com as peças que se movem. Mantenha os dedos afastados da abertura de saída dos alimentos.
- Não use sem o prato dispensador colocado. **Se o prato dispensador não estiver colocado, os alimentos entopem por baixo da placa de corte, não saem do orifício de alimentação e danificam o seu acessório.**
- Se os alimentos não estiverem a sair pela saída dos alimentos, desligue e confirme que não estão obstruídos por baixo do disco e que o disco dispensador está colocado. Retire todos os alimentos presos antes de continuar a processar.
- **Não faça funcionar o acessório Express Serve mais de 2 minutos seguidos. Deixe arrefecer durante 2 minutos a cada 2 minutos de funcionamento.**

Segurança do Liquidificador/Picador Pessoal

-  **NÃO** processe ingredientes quentes.
-  **NÃO** liquidifique líquidos com gás.
- **RISCO DE QUEIMADURAS:** Deixe arrefecer os ingredientes quentes até à temperatura ambiente antes de os colocar no copo ou antes de liquidificar.
- Não guarde os ingredientes no copo mais de 24 horas.
- Tenha **sempre** cuidado quando manusear o dispositivo de lâmina e evite tocar nas extremidades cortantes das lâminas quando as estiver a limpar.
- **Nunca** ponha a funcionar o liquidificador/picador vazio.
- Receitas de Smoothies - nunca liquidifique alimentos congelados que tenham formado uma massa sólida durante o congelamento; deve parti-los aos pedaços antes de os adicionar no copo.
- Utilize o copo apenas com o dispositivo de lâmina fornecido.
- **Nunca** beba líquidos quentes directamente do copo.
- Quando beber através da tampa, confirme que a bebida está fluída. Pode ser necessário realizar inicialmente algumas tentativas antes de conseguir obter os resultados desejados, especialmente quando utilizar alimentos duros ou verdes uma vez que alguns alimentos podem continuar na sua forma inicial.

- **Não** liquidifique ingredientes congelados sem líquido (excepto cubos de gelo).
- **Nunca** liquidifique frutos congelados ou vegetais em pedaços maiores do que 3 cm x 3 centímetros.
- **Nunca** liquidifique ingredientes secos (ex. especiarias, nozes) nem ponha a trabalhar o liquidificador/picador vazio.
- **Nunca** coloque o dispositivo de lâminas na unidade motriz sem o copo colocado.
- Retire **sempre** os caroços dos frutos secos antes de picar.

Consumo de Energia

- Quando o aparelho não está a funcionar
 - Mudança automática para o modo OFF: Não aplicável
 - Potência do Modo OFF: $\leq 0,3W$.



Antes de ligar à corrente

- Certifique-se de que a corrente eléctrica que vai utilizar corresponde à indicada na parte de baixo da máquina.
- Este aparelho está conforme com a Directiva n.º 1935/2004 da Comunidade Europeia sobre materiais concebidos para estarem em contacto com alimentos.











Antes de usar pela primeira vez

- 1 Retire a tampa plástica da unidade de lâmina. Tenha cuidado, as lâminas estão muito afiadas. Esta tampa de protecção deve ser deitada fora uma vez que servem apenas para protecção durante o fabrico e transporte.
- 2 Lave os componentes: ver “Cuidados e limpeza”.

Cuidados e limpeza

			
	X	X	✓
	✓	✓	X
	✓	✓	X
	✓	✓	X
	✓	✓	X
	✓	✓	X
	✓	✓	X
	✓	✓	X
	✓	✓	X

Cuidados e limpeza

			
	X	X	✓
	✓	✓	X
	✓	✓	X
	✓	✓	X
	✓	✓	X
	✓	✓	X
	✓	✓	X

- Desligue e espere que o acessório e as lâminas parem e retire a ficha da tomada eléctrica antes de limpar.
- Limpe a unidade motriz com um pano húmido e seque em seguida. Assegure-se de que a zona de fixação não contém alimentos.
- Não submerja a unidade motriz em água.
- Manuseie as lâminas e os discos com cuidado - estão extremamente afiados.
- Se lavar as lâminas do liquidificador/picador pessoal à mão, eles devem ser lavados com escova e enxaguados em água corrente.

Lista de Componentes

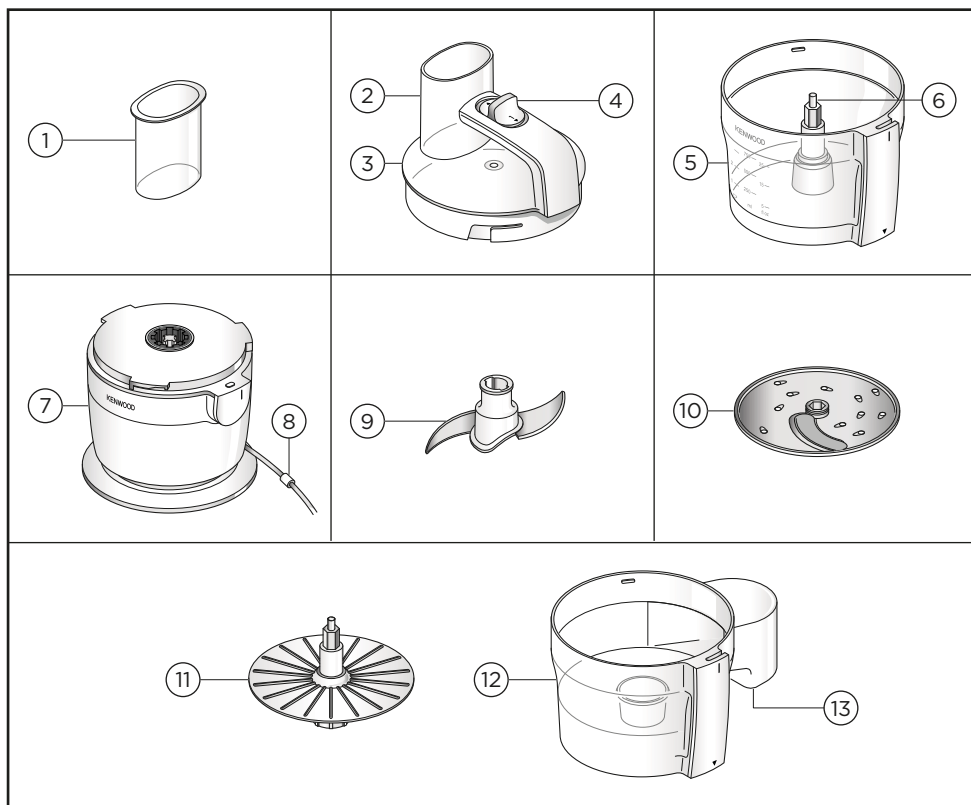

* Se proporciona

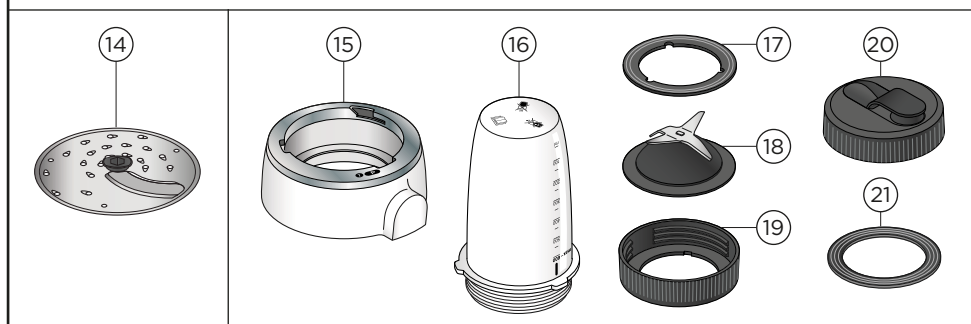

Legenda

Processador de Alimentos

- ① Empurradores
- ② Tubo de alimentação
- ③ Tampa
- ④ Botão On/Off + Impulso
- ⑤ Taça
- ⑥ Accionador interno da taça
- ⑦ Unidade motriz
- ⑧ Clipe de fixação do cabo eléctrico
- ⑨ Unidade de lâminas
- ⑩ Disco de fatiar/ralar 4 mm

Express Serve

- ⑪ Prato dispensador
- ⑫ Taça Express Serve
- ⑬ Saída dos alimentos

Diso

- ⑭ Disco de fatiar/ralar 2 mm (se fornecido)

Segurança do Liquidificador/Picador Pessoal

- ⑮ Base do Liquidificador/Picador Pessoal
- ⑯ Copo
- ⑰ Anel Vedante
- ⑱ Unidade de Lâminas
- ⑲ Suporte das lâminas
- ⑳ Tampa para Beber
- ㉑ Anel Vedante da Tampa para Beber

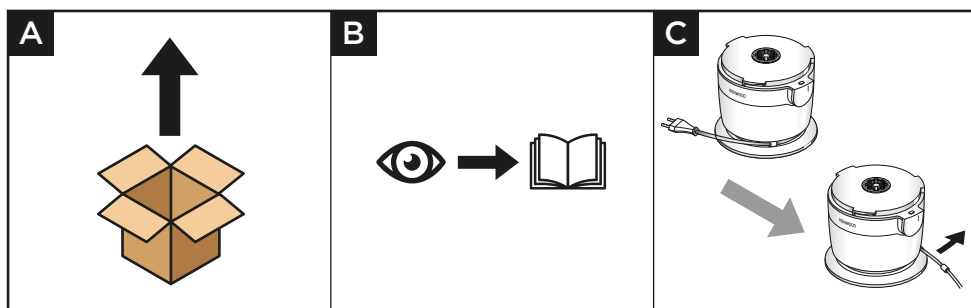

Para Usar o Seu Processador de Alimentos - Unidade de Lâminas

Utilização dos Diagramas e Instruções

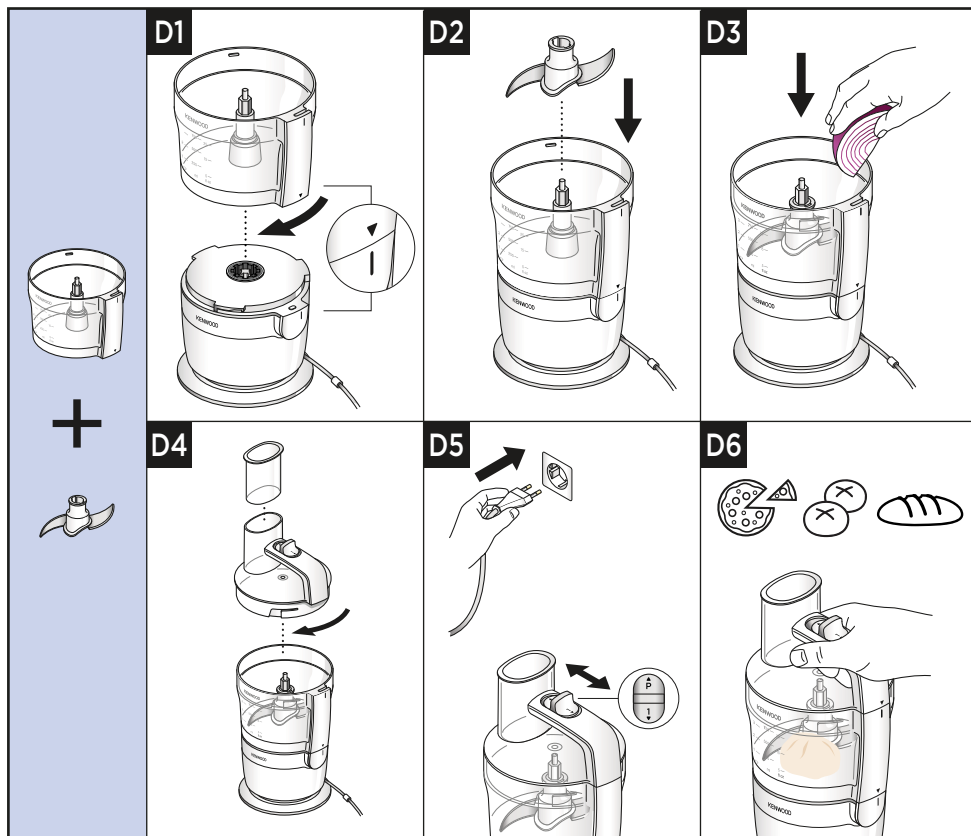

Importante





























- O seu processador não é apropriado para esmagar ou moer grãos de café e especiarias, transformar açúcar granulado em açúcar em pó ou processar cubos de gelo.
- Quando adicionar essência ou aroma de amêndoa às misturas, evite o contacto com as peças de plástico pois tal pode resultar em manchas permanentes.
- Coloque sempre a taça e acessório no processador antes de colocar os ingredientes.
- Não utilize a tampa para operar o processador.
- O robot não funcionará se a taça ou a tampa não estiverem colocadas correctamente no mecanismo de engate. Confirme que o tubo de alimentação e a pega da taça estão posicionados no canto direito da frente.
- Desligue sempre e retire o cabo eléctrico da tomada antes de retirar a tampa.
- Massas para pão - não processe mais de 30 segundos.
- Re-amasse a massa para pão apenas à mão. Não se aconselha que amasse novamente na máquina uma vez que esta pode ficar instável.
- Segure sempre a unidade pela pega quando processar massa.

- 1 Coloque a taça na unidade motriz e gire na direcção dos ponteiros do relógio para prender.
- 2 Coloque a unidade de lâmina por cima do eixo accionador.
- 3 Adicione os ingredientes na taça do processador de alimentos.
- 4 Coloque a tampa.
- 5 Ligue a unidade à corrente eléctrica.
- 6 Ligue a unidade ou utilize a função de impulso.

Dicas e Sugestões

- Utilize o botão (P) para pequenos arranques. O botão funcionará enquanto o controlo for mantido na mesma posição.
- Alguns alimentos podem colorir o plástico. Isto é normal e não estraga o plástico ou afecta o sabor dos seus alimentos. Esfregue um pano embebido em óleo para ajudar a retirar a coloração.
- **Massa para Pão** - Coloque primeiro os alimentos secos na taça e adicione depois o líquido. Processe até formar uma bola elástica e macia.
- Utilize a pega da tampa para segurar o aparelho se este começar a mover-se na bancada de trabalho.
- Para texturas mais grossas utilize o controlo de impulso.
- Tenha cuidado para não misturar demasiado.
- Quando confeccionar massa para bolos utilize a gordura (margarina, manteiga ou outra) directamente do frigorífico e cortada em cubos de 2cm.

Quadro de Utilização

E	 MAX (g)	 (Seg.)
	20-30	10-20
	200	30
	150	20-30
	 2 cm	10/P
	 1/4	P
	 2-3 cm	15-20
	 2 cm	20
	400	60
	x3  + 300 ml 	45-60
	250 g  + 150 g 	30
	250 g 	10-30
	 x3 +  150 g +  150 g +  18-22°C +  150 g	20

Receita

Marinada de Ameixas

400g de Mel

40g de Ameixas e

50ml de água

- 1 Guarde no frigorífico durante a noite.
- 2 Processe durante 4 segundos usando o Impulso (Pulse).

Para Usar o Seu Processador de Alimentos - Discos

Utilização dos Diagramas e Instruções

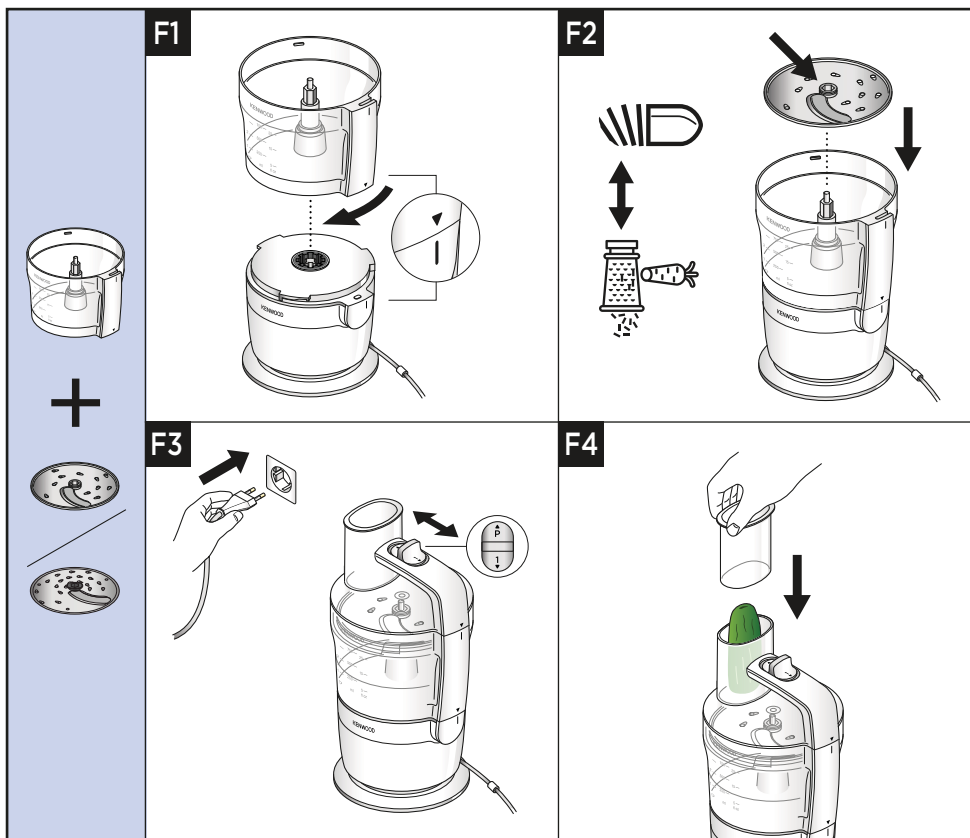

Importante











- Nunca introduza os seus dedos no tubo de alimentação.

- 1 Coloque a taça na unidade motriz e gire na direcção dos ponteiros do relógio para prender.
- 2 Segurando pelo suporte central, coloque o disco de corte no eixo accionador com o lado apropriado virado para cima.
- 3 Coloque a tampa.
- 4 Coloque os alimentos no tubo de alimentação.
- 5 Ligue à corrente eléctrica e empurre uniformemente os alimentos para baixo com o empurrador.

Dicas e Sugestões

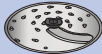
- Utilize ingredientes frescos.
- Não corte os alimentos muito pequenos. Encha o tubo de alimentação com os seus ingredientes (evitando apertar demasiado os alimentos), para evitar que os alimentos deslizem para os lados enquanto os processa.
- Quando fatiar ou ralar: os alimentos colocados verticalmente saem mais pequenos que os alimentos colocados na horizontal.
- Existirá sempre uma pequena perda de alimentos que ficarão no disco ou na taça depois de processados.

Quadro de Utilização

G 	 MAX (g)	 (Seg.)
	750 ml 	10-20
	750 ml 	10-20
	 MAX (g)	 (Seg.)
	750 ml 	10-20

Para Usar o Seu Express Serve

Utilização dos Diagramas e Instruções

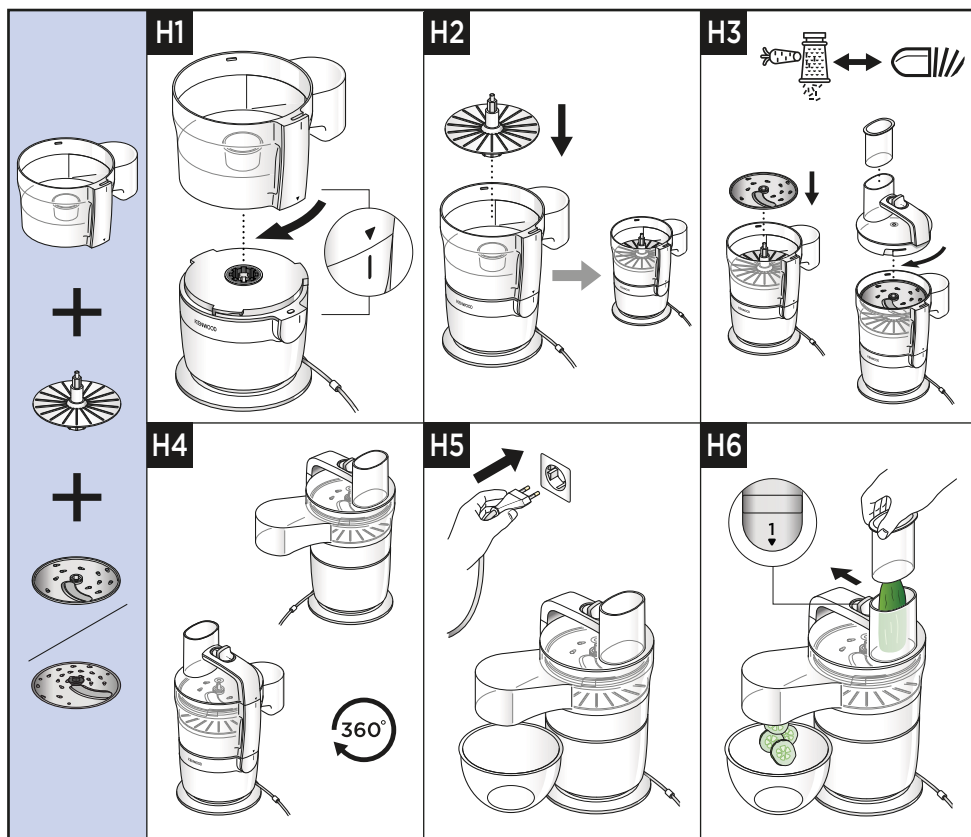











Importante

- Não aplique força excessiva quando utilizar o acessório.
- Se os alimentos não saírem pela saída dos alimentos, desligue e confirme que não estão obstruídos por baixo do disco e que o disco dispensador está colocado. Retire todos os alimentos presos antes de continuar a processar.

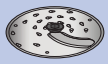
- 1 Coloque a taça na unidade motriz e gire na direcção dos ponteiros do relógio para prender.
- 2 Insira o disco dispensador e o disco desejado.
- 3 Accionador interno da taça.
- 4 Coloque os alimentos no tubo de alimentação.
- 5 Ligue à tomada eléctrica, ligue na velocidade 1 e empurre uniformemente os alimentos para baixo com o empurrador.

Quadro de Utilização

I 	 MAX (g)	 (Seg.)
		120
		120
	 MAX (g)	 (Seg.)
		120

Para Usar o Seu Liquidificador/Picador Pessoal

Utilização dos Diagramas e Instruções

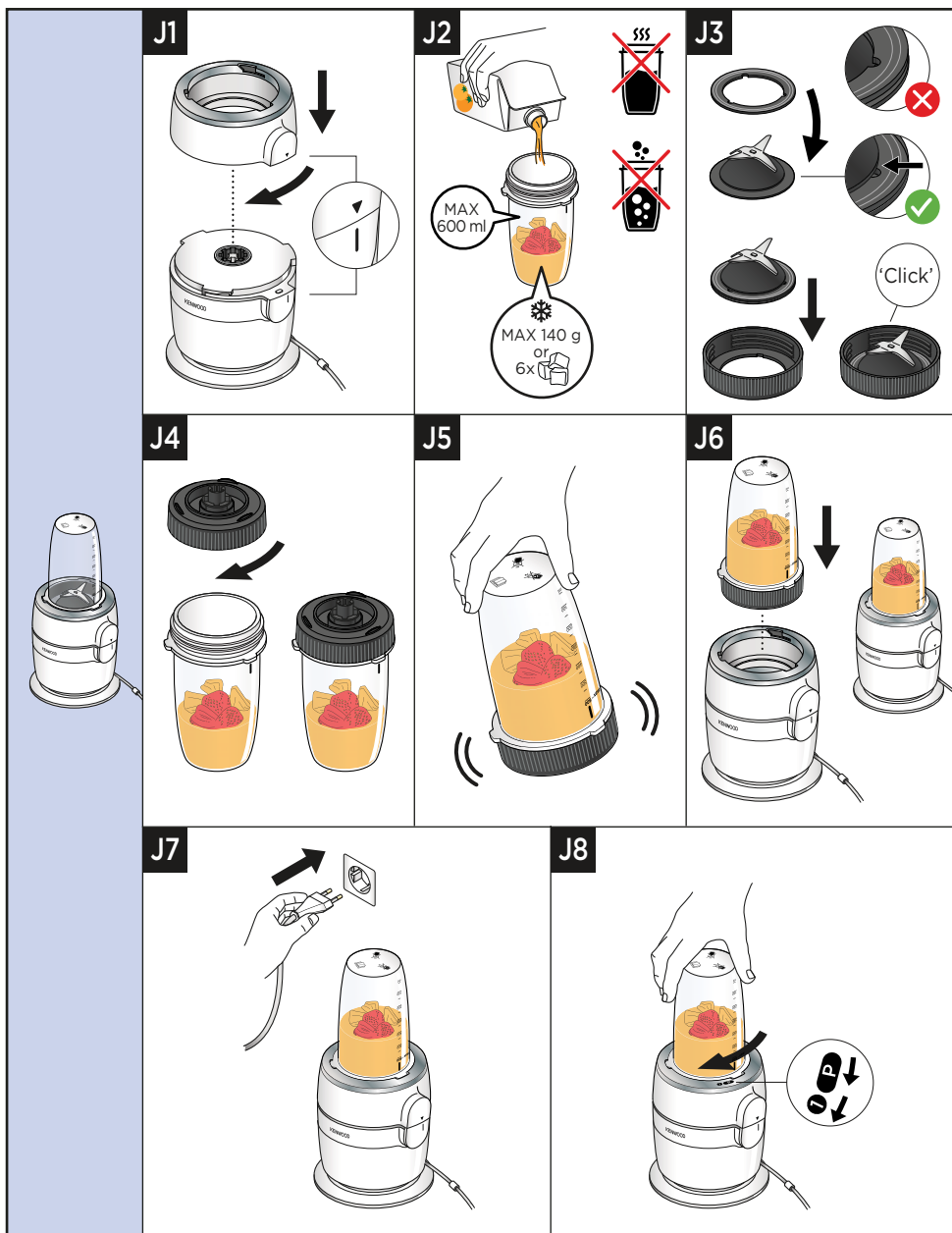

Para Usar o Seu Liquidificador/Picador Pessoal

Utilização dos Diagramas e Instruções

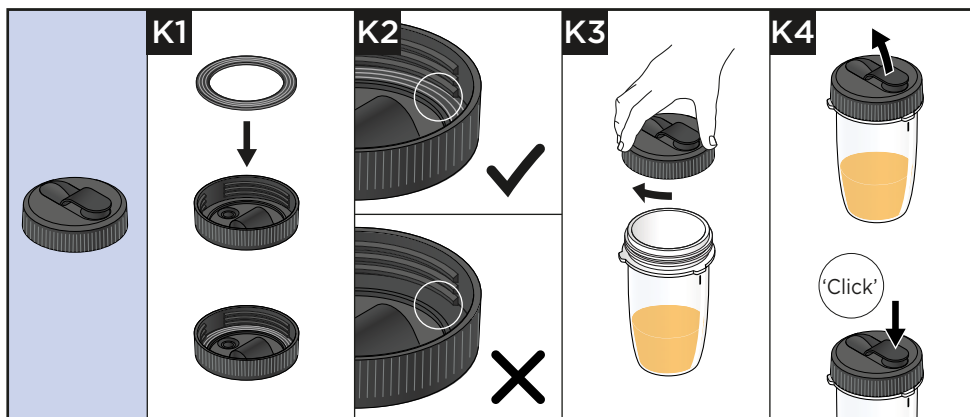

Importante

- A base do liquidificador/picador pessoal deve ser colocada na unidade motriz ANTES do liquidificador/picador pessoal.
- **Não** liquidifique ingredientes congelados sem líquido (excepto cubos de gelo).
- Se o anel vedante estiver danificado ou mal colocado, vai ocorrer vazamento.
- Nunca liquidifique alimentos congelados que tenham formado uma massa sólida.
- Nunca liquidifique frutos congelados ou vegetais em pedaços maiores do que 3 cm x 3 centímetros.
- Para obter um melhor desempenho coloque na garrafa sempre em primeiro lugar o gelo / ingredientes congelados.
- Retire **sempre** os caroços dos frutos secos antes de picar.

- 1 Coloque o liquidificador/picador pessoal na unidade motriz e gire na direcção dos ponteiros do relógio até prender.
- 2 Adicione os ingredientes ao copo, até ao nível 600 ml.
- 3 Coloque o anel vedante na unidade de lâmina assegurando-se de que está correctamente preso na área ranhurada.
- 4 Cuidadosamente, insira a unidade de lâmina no suporte da lâmina e prenda-a no sítio.
- 5 Segure pela parte de baixo do suporte da lâmina já montado e insira-o no copo com as lâminas viradas para baixo.
- 6 Atarraxe o suporte da unidade de lâmina no copo - gire no sentido dos ponteiros do relógio para prender.
- 7 Agite para distribuir os ingredientes.
- 8 Introduza o acessório na unidade motriz.
- 9 Ligue à corrente eléctrica. Para seleccionar a velocidade impulso, gire no sentido dos ponteiros do relógio (em direcção ao P) e liberte o acessório. Para seleccionar a velocidade contínua gire o acessório no sentido dos ponteiros do relógio (em direcção ao 1) até prender.











Tampa para Beber

- 10 Coloque o anel vedante na tampa para beber assegurando-se de que está correctamente preso na área ranhurada.
- 11 Para usar a tampa para beber, desatarraxe o suporte da unidade de lâminas do copo. Insira e prenda a tampa para beber girando-a no sentido dos ponteiros do relógio.
- 12 Quando quiser beber, basta abrir a pequena cobertura da tampa. A bebida pode ser consumida directamente da garrafa.
- 13 Depois de beber, feche a cobertura da tampa. Prima firmemente para prender.

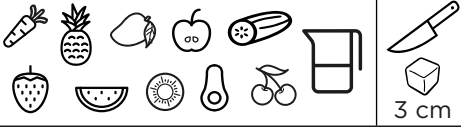
Dicas e Sugestões

- Note que quando o copo está cheio até ao máximo (600ml), esta fornece aproximadamente duas porções.
- Se não pretende consumir imediatamente a sua bebida, guarde-a no frigorífico e beba-a no prazo de 24 horas.
- Certifique-se de que a sua bebida é suficientemente fina para poder bebê-la pela tampa distribuidora. Para fazer a sua bebida mais fina, adicione mais líquido.
- Após a mistura, algumas bebidas podem não ficar completamente suaves por causa das sementes ou da natureza fibrosa dos ingredientes.
- Algumas bebidas podem separar-se com o tempo de espera. É portanto aconselhável o seu consumo imediato. Bebidas separadas devem ser misturadas antes de serem consumidas.
- Quando a tampa distribuidora está colocada, tenha sempre o copo virado para cima.

Quadro de Utilização

L		 MAX (g)		 (Seg.)
		600 ml	1	30-60
		100 g	10-20	P
		X 6 120-140 g	P	10-20
		50 g	P	10-20
		100 g	1	30-60
		50 g	P	10

Receitas

Pesto

60 g de Basilíco Fresco
1 Dente de Alho
25 g de Pinhões
25 g de Queijo Parmesão Ralado
110 g de Azeite
Sal a gosto
Pimenta a gosto

- 1 Coloque todos ingredientes no copo do liquidificador/picador. Utilize o impulso 5 vezes, seguido do processamento contínuo até chegar à consistência desejada (aproximadamente 25 segundos).

Marinada de Ameixas

300 g de Mel
40 g de Ameixas
70 ml de Água

- 1 Coloque todos ingredientes no copo do liquidificador/picador. Guarde no frigorífico durante a noite. (Não guarde os ingredientes no copo mais de 24 horas).
- 2 Processe durante 4 segundos usando o impulso. Use imediatamente.

Ajustar o cabo eléctrico

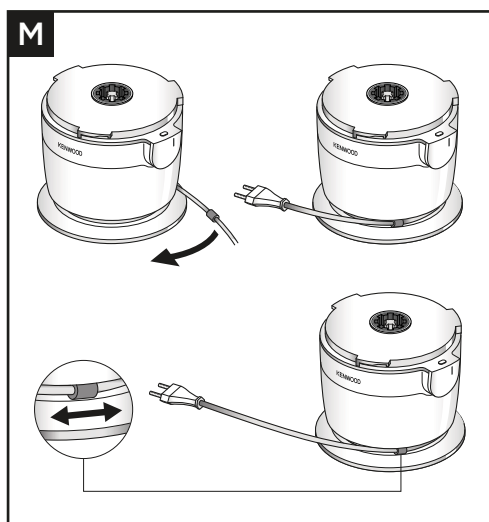

- Enrole o cabo à volta da base do processador até ao comprimento desejado e prenda o cabo usando o clipe de fixação.

Armazenamento

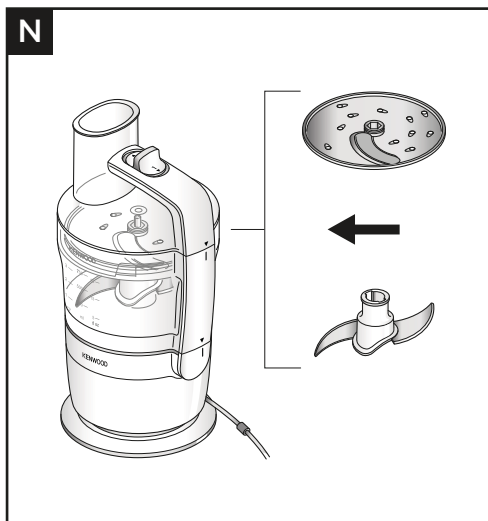

- Depois da utilização, a lâmina e o disco podem ser armazenados juntos na taça.
- O segundo disco (se fornecido) pode ser armazenado na taça do Express Serve.
- **Não** utilize a unidade de lâmina e um disco em simultâneo quando usa o processador. Use apenas um acessório de cada vez.

Assistência e cuidados ao cliente

- Se tiver qualquer problema ao utilizar o seu aparelho, antes de telefonar para a Assistência consulte a secção “Guia de avarias” do Manual ou visite o site da Kenwood em www.kenwoodworld.com.
- Salientamos que o seu produto está abrangido por uma garantia, em total conformidade com todas as disposições legais relativas a quaisquer disposições sobre garantias e com os direitos do consumidor existentes no país onde o produto foi adquirido.
- Se o seu produto Kenwood funcionar mal ou lhe encontrar algum defeito, agradecemos que o envie ou entregue num Centro de Assistência Kenwood autorizado. Para encontrar informações actualizadas sobre o Centro de Assistência Kenwood autorizado mais próximo de si, visite por favor o site www.kenwoodworld.com ou o website específico do seu país.
- Concebido e projectado no Reino Unido pela Kenwood.
- Fabricado na China.



ADVERTÊNCIAS PARA A ELIMINAÇÃO CORRECTA DO PRODUTO NOS TERMOS DA DIRECTIVA EUROPEIA RELATIVA AOS RESÍDUOS DE EQUIPAMENTOS ELÉCTRICOS E ELECTRÓNICOS (REEE)

No final da sua vida útil, o produto não deve ser eliminado conjuntamente com os resíduos urbanos.

Pode ser depositado nos centros especializados de recolha diferenciada das autoridades locais, ou junto dos revendedores que prestem esse serviço.

Guia de avarias

Problema	Causa	Solução
O processador não funciona.	Falta de energia.	Verifique se o processador está ligado à corrente.
	A taça não está correctamente colocada na unidade motriz.	O processador não funcionará se a taça ou a tampa não estiverem colocadas correctamente no mecanismo de engate.
	A tampa da taça não está correctamente presa.	Verifique que a taça e a tampa estão correctamente alinhadas e presas.
O processador pára durante o funcionamento.	Excedida a capacidade máxima do processador.	Consulte as capacidades máximas no “Quadro de Utilização Recomendada”.
	Tampa não presa.	Verifique se a tampa está correctamente presa.
Não consegue colocar a taça na base com a tampa colocada.	O botão On/Off está na posição “On”.	Ponha o botão On/Off na posição “Off”.
Os alimentos não estão a sair pela saída do express serve.	O prato dispensador não está colocado por baixo do disco de ralar / fatiar.	Coloque o prato dispensador.
Alimentos fatiados ou ralados estragados pela lâmina.	A funcionar com a lâmina e o disco na taça ao mesmo tempo.	Retire a lâmina antes de utilizar o disco de ralar / fatiar.
Unidade instável / grandes vibrações e movimento.	A massa processou demasiado tempo. Excedida a capacidade máxima do processador.	Utilize a pega da tampa para segurar o aparelho se este começar a mover-se na bancada de trabalho. Não processe massas mais do que 30 segundos seguidos e não exceda a quantidade máxima estipulada no quadro de utilização recomendada.
	A massa está a amassar novamente.	Volte a amassar apenas à mão. Não se aconselha que amasse novamente na máquina uma vez que esta pode ficar instável.
	Está a processar frutos / ingredientes pegajosos.	Para obter melhores resultados comece por utilizar o “Impulso” para partir os ingredientes e depois processe continuamente.
Muitos salpicos ou ingredientes a saltar pelo tubo de alimentação.	O empurrador não está colocado no tubo de alimentação.	Coloque sempre o empurrador quando processar qualquer tipo de massa para evitar salpicos pelo tubo de alimentação.
Fraco desempenho da lâmina e disco.	Consulte a secção Dicas e Sugestões e siga o quadro de utilização recomendada.	

Guia de avarias

Problema	Causa	Solução
O Liquidificador/ Moinho Pessoal não funciona.	O Liquidificador/ Moinho Pessoal não está correctamente preso. A Base do Liquidificador/ Moinho Pessoal não está correctamente presa.	O Liquidificador/Moinho Pessoal não funcionará se não estiver correctamente preso nos engates de segurança.
O Liquidificador/ Moinho Pessoal verte pela base do dispositivo de lâmina.	Falta o anel vedante. Anel vedante incorrectamente instalado. Anel vedante danificado. Suporte da lâmina não está totalmente/correctamente apertado.	Verifique se o suporte da lâmina está totalmente atarraxado. Verifique se o selo vedante está correctamente colocado na ranhura, como mostrado no diagrama J3, e não está danificado. Para obter um anel vedante de substituição, ver “Assistência e cuidados do cliente”.
O Liquidificador/ Moinho Pessoal verte pela tampa distribuidora.	Tampa não presa.	Verifique se a tampa está correctamente presa.

Español

- Información importante sobre seguridad [147-149](#)
- Antes de enchufar el aparato [149](#)
- Cuidado y limpieza [150-151](#)
- Lista de las partes [152-153](#)
- Usar el procesador de alimentos - Cuchilla [154-156](#)
 - Diagramas de uso e instrucciones de uso [154-155](#)
 - Tabla de usos [156](#)
 - Receta [156](#)
- Usar el procesador de alimentos - Discos [157-158](#)
 - Diagramas de uso e instrucciones de uso [157-158](#)
 - Tabla de usos [158](#)
- Usar el Express Serve [159-160](#)
 - Diagramas de uso e instrucciones de uso [159](#)
 - Tabla de usos [160](#)
- Usar la batidora de vaso personal/picadora [161-165](#)
 - Diagramas de uso e instrucciones de uso [161-163](#)
 - Tabla de usos [164](#)
 - Recetas [165](#)
- Ajuste del cable [165](#)
- Almacenamiento [166](#)
- Servicio técnico y atención al cliente [167](#)
- Guía de solución de problemas [168-169](#)

Información importante sobre seguridad



- Lea estas instrucciones atentamente y guárdelas para poder utilizarlas en el futuro.
- Antes de utilizar el aparato por primera vez, quite todo el embalaje, los folletos publicitarios y los protectores de plástico de las cuchillas. Para lavar las piezas, consulte 'Cuidado y limpieza'.
- Si el enchufe o el cable están dañados, por razones de seguridad, deben ser sustituidos por Kenwood o por un técnico autorizado por Kenwood para evitar posibles riesgos.
- **NO toque las cuchillas afiladas.** Las cuchillas y los discos están muy afilados, manéjelos con cuidado. **Sosténgalos siempre por el asa en la parte superior, lejos del borde cortante, al manipular las cuchillas afiladas, vaciar el bol y durante la limpieza.**
- **El bol del procesador de alimentos y el Express Serve no son adecuados para procesar cubitos de hielo.**
- Antes de levantar o transportar el aparato por el asa de la tapa, compruebe siempre que el bol y la tapa estén bien sujetos en su posición.
- **No** procese ingredientes calientes en ninguno de los recipientes suministrados, incluida la batidora de vaso personal. Los líquidos calientes pueden salir despedidos del aparato debido a la generación repentina de vapor.
- **No** deje nunca el aparato desatendido mientras esté en marcha.
- **No** mueva el aparato mientras esté en marcha.
- **No** sobrepase las capacidades máximas indicadas en la tabla de usos recomendados.
- **No haga funcionar el aparato durante más de 30 segundos seguidos al procesar masa sin un período de descanso de 5 minutos. Si lo hace funcionar de manera continuada durante períodos de tiempo más largos, puede dañar el aparato.**
- Retire **siempre** la cuchilla y los discos antes de verter el contenido del bol del procesador de alimentos.
- Mantenga las manos y los utensilios alejados del bol del procesador de alimentos mientras el aparato esté conectado a la toma de corriente.
- Si hay que empujar la comida hacia abajo en el bol del procesador de alimentos, use un utensilio adecuado, como una espátula.
- **Nunca** utilice los dedos para empujar los alimentos por el tubo de entrada. Utilice siempre el empujador que se suministra.
- Apague **siempre** el aparato y desconéctelo de la toma de corriente si se deja desatendido y antes de montarlo, desmontarlo o limpiarlo.
- AVISO: antes de quitar la tapa del bol espere hasta que el accesorio/las cuchillas se hayan parado totalmente.
- **No** haga una fuerza excesiva para empujar los alimentos por el tubo de entrada ya que podría dañar el aparato.
- **No** utilice el bloqueo de la tapa para hacer funcionar el procesador; utilice siempre el control de velocidad de encendido/apagado.
- **No** haga funcionar el procesador con la cuchilla y el disco colocados los dos a la vez. Use solamente un accesorio a la vez.

- **Este aparato se estropeará y puede producir lesiones si el mecanismo de enclavamiento se ve sometido a una fuerza excesiva.**
- Nunca utilice un accesorio no autorizado.
- Nunca utilice un aparato dañado. Para solicitar que lo revisen o lo reparen consulte: “Servicio técnico y atención al cliente”.
- Nunca permita que se mojen la unidad de potencia, el cable o el enchufe.
- No deje que el exceso de cable cuelgue de la mesa o la encimera ni que toque superficies calientes.
- Hay que vigilar a los niños para asegurarse de que no jueguen con el aparato.
- Este aparato no debe ser utilizado por niños. Mantenga el aparato y su cable fuera del alcance de los niños.
- Este aparato puede ser utilizado por personas con capacidades físicas, sensoriales o mentales disminuidas o con falta de experiencia o conocimientos si han recibido instrucciones o supervisión en relación con el uso del aparato de forma segura y si entienden los peligros que ello implica.
- Utilice este aparato únicamente para el uso doméstico al que está destinado. Kenwood no se hará cargo de responsabilidad alguna si el aparato se somete a un uso inadecuado o si no se siguen estas instrucciones.
- El uso incorrecto de su aparato puede producir lesiones.

Express Serve

- Evite el contacto con las piezas móviles. Mantenga los dedos fuera de la abertura de descarga de alimentos.
- No haga funcionar el aparato sin que la placa de expulsión esté acoplada. **Si la placa de expulsión no está acoplada, la comida se atascará debajo del disco y no saldrá por la salida de alimentos, lo que podría dañar el accesorio.**
- Si la comida no sale por la salida de alimentos, apague el aparato y compruebe que no haya comida atascada debajo del disco y que la placa de expulsión esté colocada. Quite la comida que haya quedado atrapada antes de seguir procesando los alimentos.
- **No haga funcionar el accesorio Express Serve durante más de 2 minutos seguidos. Déjelo enfriar durante 2 minutos entre cada funcionamiento de 2 minutos.**

Seguridad de la batidora de vaso personal/picadora

-  **NO** procese ingredientes calientes.
-  **NO** mezcle líquidos gaseosos.
- **RIESGO DE ESCALDARSE:** hay que dejar que los ingredientes calientes se enfríen a temperatura ambiente antes de ponerlos en el vaso o antes de mezclarlos.
- No guarde los ingredientes en el vaso durante más de 24 horas.
- Maneje **siempre** con cuidado el conjunto de cuchillas y evite tocar el borde cortante de las cuchillas al limpiar el aparato.
- **Nunca** ponga la batidora de vaso/picadora en marcha vacía.
- Elaboración de smoothies: nunca bata ingredientes congelados que hayan formado una masa sólida durante la congelación; trocéelos antes de añadirlos al vaso.
- Utilice el vaso únicamente con el conjunto de cuchillas suministrado.
- **Nunca** beba líquidos calientes del vaso.

- Al beber por la tapa, compruebe que la bebida esté suave. Puede ser necesario hacer experimentos para lograr el resultado deseado, particularmente al procesar alimentos duros o no maduros ya que algunos ingredientes pueden quedar sin procesar.
- **No** mezcle ingredientes congelados sin líquido (excepto cubitos de hielo).
- **Nunca** bata trozos de fruta o verdura congelada que sean más grandes que dados de 3 cm x 3 cm.
- **Nunca** mezcle ingredientes secos (p. ej. especias o frutos secos) ni ponga la batidora de vaso/picadora en marcha vacía.
- **Nunca** acople el conjunto de cuchillas a la unidad de potencia sin que el vaso esté colocado.
- Quite **siempre** los huesos de la fruta deshidratada antes de trocearla.

Consumo de energía

- Cuando el aparato no está en funcionamiento
 - Cambio automático al modo apagado: no procede
 - Potencia del modo apagado: $\leq 0,3$ W.

Antes de enchufar el aparato

- Asegúrese de que el suministro de energía eléctrica sea el mismo que el que se muestra en la parte inferior del aparato.
- Este dispositivo cumple con el reglamento (CE) n.º 1935/2004 sobre los materiales y objetos destinados a entrar en contacto con alimentos.











Antes de utilizar el aparato por primera vez

- 1 Quite el protector de plástico de la cuchilla. Las cuchillas están muy afiladas, manéjelas con cuidado. No guarde el protector ya que solo se utiliza para proteger la cuchilla durante el proceso de fabricación y el transporte.
- 2 Para lavar las piezas, consulte “Cuidado y limpieza”.

Cuidado y limpieza

			
	X	X	✓
	✓	✓	X
	✓	✓	X
	✓	✓	X
	✓	✓	X
	✓	✓	X
	✓	✓	X
	✓	✓	X
	✓	✓	X

Cuidado y limpieza

			
	X	X	✓
	✓	✓	X
	✓	✓	X
	✓	✓	X
	✓	✓	X
	✓	✓	X
	✓	✓	X

- Apague el aparato, espere a que el accesorio/las cuchillas se detengan y desenchúfelo antes de limpiarlo.
- Limpie la unidad de potencia con un paño húmedo y luego séquela bien. Asegúrese de que el área de enclavamiento no presente restos de comida.
- No sumerja la unidad de potencia en agua.
- Maneje las cuchillas y los discos de corte con cuidado, ya que están muy afilados.
- Si lava las cuchillas de la batidora de vaso personal/picadora a mano, debe limpiarlas con un cepillo y enjuagarlas con agua corriente.

Lista de las partes

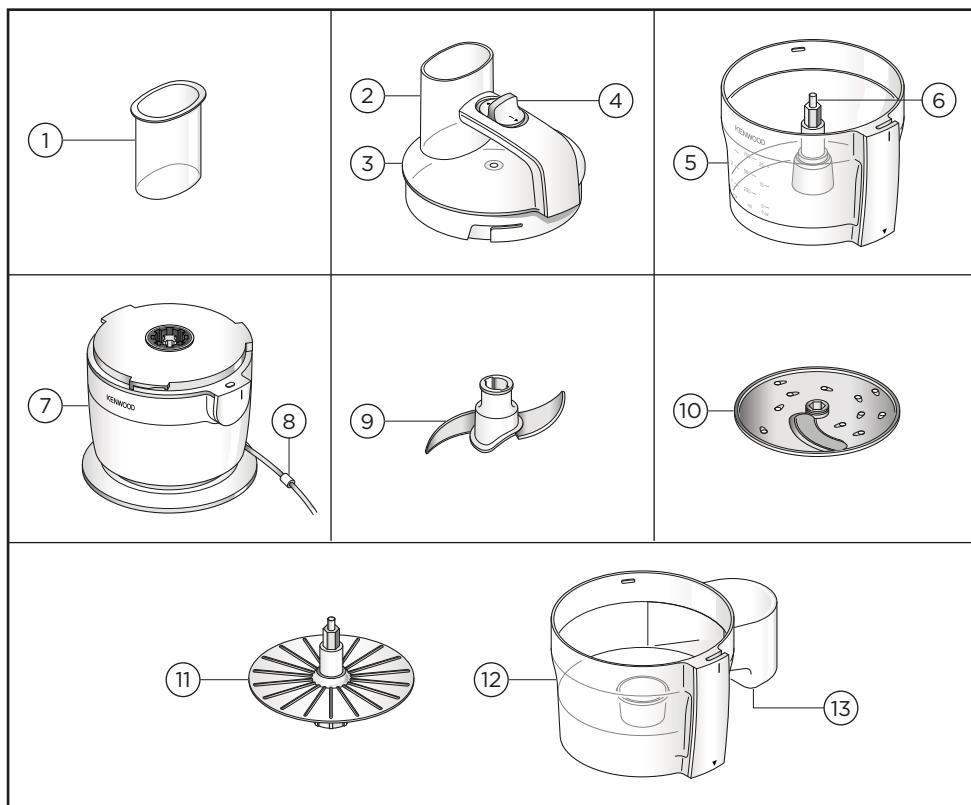

* Si se incluye

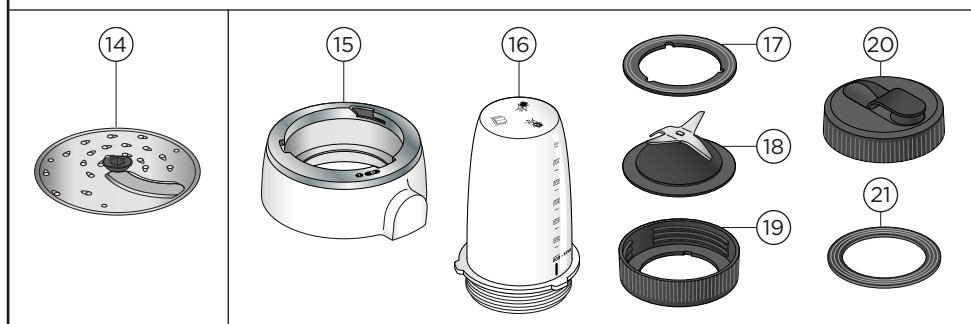

Descripción del aparato

Processor

- ① Empujador
- ② Tubo de entrada de alimentos
- ③ Tapa
- ④ Interruptor de encendido/apagado + Control de acción intermitente
- ⑤ Bol
- ⑥ Eje motor integrado en el bol
- ⑦ Unidad de potencia
- ⑧ Clip para el cable
- ⑨ Cuchilla
- ⑩ Disco rebanador/rallador de 4 mm

Express Serve

- ⑪ Placa de expulsión
- ⑫ Bol del Express Serve
- ⑬ Salida de alimentos

Disc

- ⑭ Disco rebanador/rallador de 2 mm (si se incluye)

Batidora de vaso personal/picadora

- ⑮ Base de la batidora de vaso personal/picadora
- ⑯ Vaso
- ⑰ Anillo de cierre
- ⑱ Unidad de cuchillas
- ⑲ Portacuchillas
- ⑳ Tapa para beber
- ㉑ Anillo de cierre de la tapa para beber

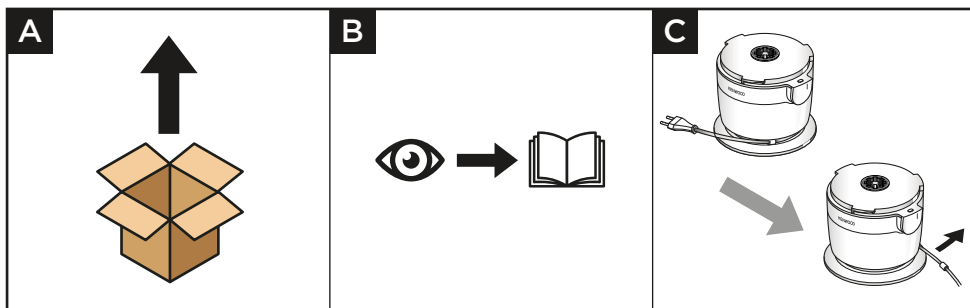

Usar el procesador de alimentos - Cuchilla

Diagramas de uso e instrucciones de uso

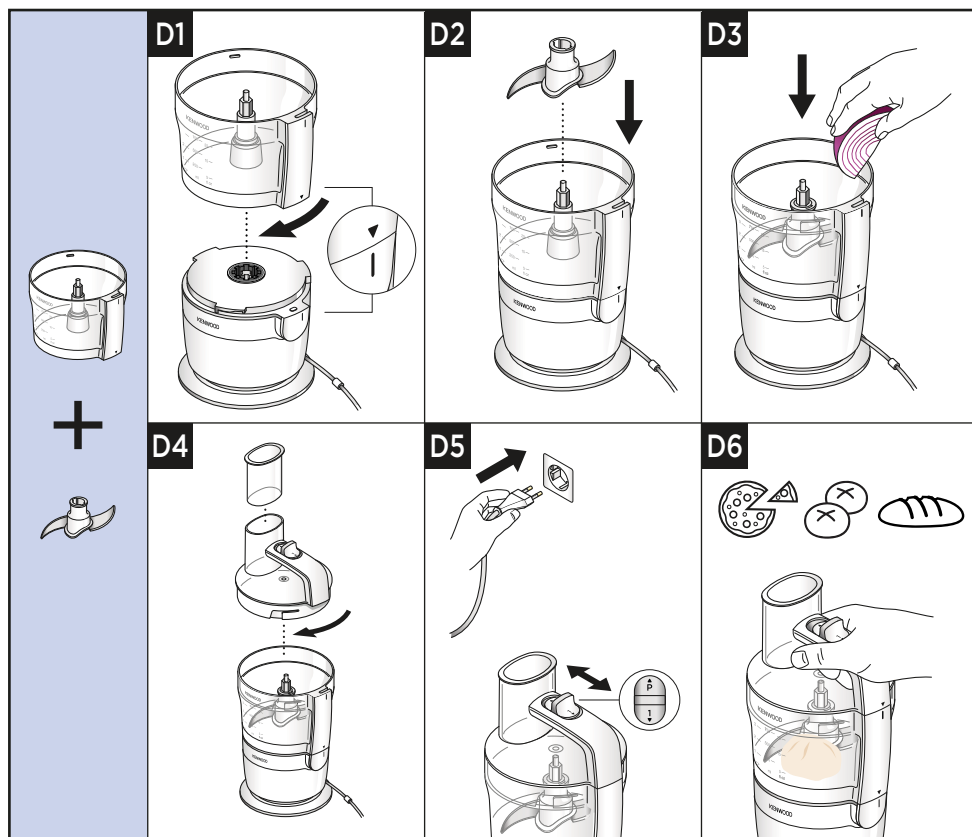

Importante





























- El procesador no es adecuado para triturar o moler granos de café y especias, convertir azúcar granulado en azúcar lustre ni para procesar cubitos de hielo.
- Si añade esencia de almendra o aromatizantes a las mezclas, evite el contacto con el plástico ya que podrían quedar manchas permanentes.
- Antes de añadir ingredientes, acople siempre el bol y el accesorio.
- No utilice la tapa para hacer funcionar el procesador.
- El procesador no funcionará si el bol o la tapa no están correctamente ajustados en el enclavamiento. Compruebe que el tubo de entrada de alimentos y el asa del bol estén situados hacia la esquina derecha de la parte delantera.
- Antes de quitar la tapa, apague y desenchufe el aparato.
- Masa de pan, no procese los ingredientes durante más de 30 segundos seguidos.
- Vuelva a amasar la masa de pan pero hágalo a mano. No es aconsejable volver a amasar en el bol, ya que esto podría afectar a la estabilidad del aparato.
- Sujete siempre la unidad por el asa cuando procese masa.

- 1 Coloque el bol sobre la unidad de potencia y gírelo en el sentido de las agujas del reloj para fijarlo en su posición.
- 2 Coloque las cuchillas sobre el eje motor.
- 3 Añada los ingredientes al bol del procesador de alimentos.
- 4 Ponga la tapa.
- 5 Enchufe la unidad a la toma de corriente eléctrica.
- 6 Encienda la unidad o utilice la función de acción intermitente.

Consejos y sugerencias

- Utilice el control de acción intermitente (P) para generar impulsos breves. El control de acción intermitente funcionará mientras se mantenga apretado.
- Algunos alimentos pueden manchar el plástico. Esto es algo totalmente normal y no causa ningún daño en el plástico ni afecta al sabor de los alimentos. Para eliminar las manchas, frote el plástico con un paño suave mojado en aceite vegetal.
- **Masa de pan** - Ponga primero los ingredientes secos en el bol y luego añada el líquido. Procese los ingredientes hasta obtener una bola de masa elástica y uniforme.
- Use el asa de la tapa para sujetar si el aparato empieza a moverse en la superficie de trabajo.
- Para obtener texturas más gruesas, utilice el control de acción intermitente.
- Tenga cuidado de no exceder el tiempo de procesamiento.
- Para hacer masa utilice manteca recién sacada de la nevera y cortada en dados de 2 cm.

Tabla de usos

E 	 MAX (g)	 (Segundos)
	20-30	10-20
	200	30
	150	20-30
 	300	10/P
 	200	P
 	250	15-20
 	100-200	20
	400	60
	x3  + 300 ml 	45-60
	250 g  + 150 g 	30
	250 g 	10-30
	 +  +  ^{18-22°C}  + 	20

Receta

Adobo de ciruela pasa

400 g miel
40 g ciruelas pasas
50 ml de agua

- 1 Consérvelos en el frigorífico durante la noche.
- 2 Procese los ingredientes durante 4 segundos usando el control de acción intermitente.

Usar el procesador de alimentos - Discos

Diagramas de uso e instrucciones de uso

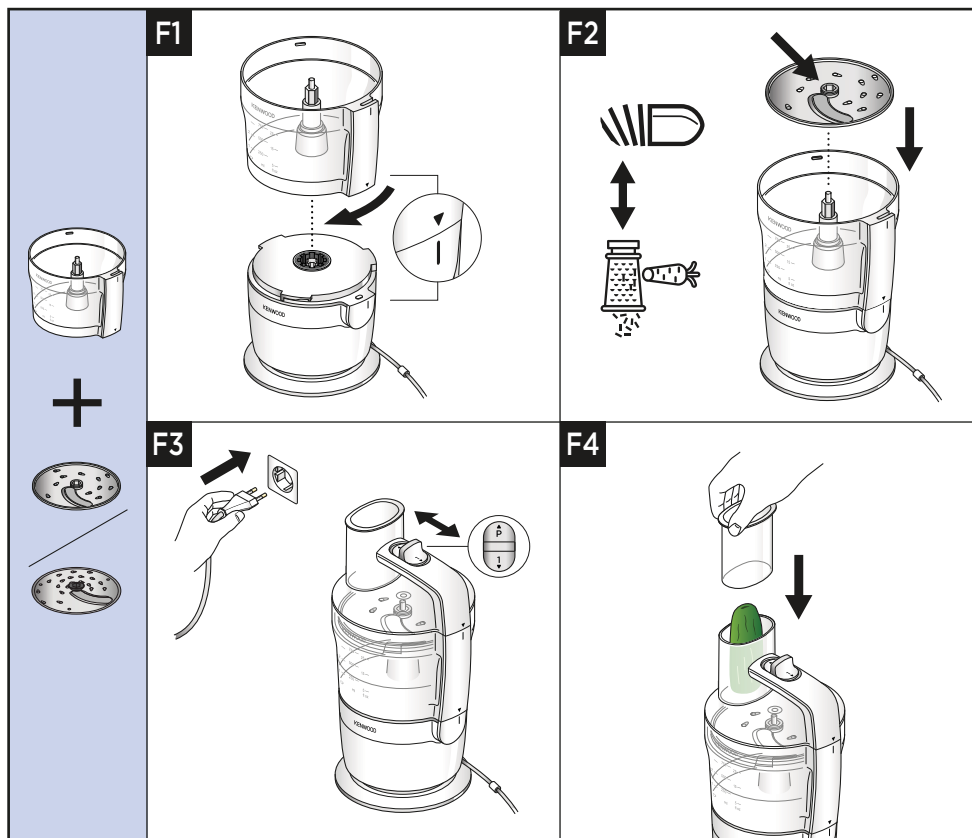

Importante













- Nunca meta los dedos en el tubo de entrada de alimentos.

- 1 Coloque el bol sobre la unidad de potencia y gírelo en el sentido de las agujas del reloj para fijarlo en su posición.
- 2 Sujetándolo por la parte central, coloque el disco sobre el eje motor con el lado apropiado hacia arriba.
- 3 Coloque la tapa.
- 4 Ponga los alimentos en el tubo de entrada de alimentos.
- 5 Enchufe el aparato, ponga el interruptor a velocidad 1 y empuje de manera uniforme con el empujador.

Consejos y sugerencias

- Utilice ingredientes frescos.
- No corte los alimentos en trozos demasiado pequeños. Llene el tubo de entrada de alimentos con los ingredientes (evitando que queden muy apretados); esto evitará que la comida se deslice hacia los lados al procesarla.
- Al rebanar o rallar: los alimentos colocados en sentido vertical salen más cortos que los que se colocan en sentido horizontal.
- Después de procesar los alimentos, siempre quedarán pequeños restos de comida en el disco o en el bol.

Tabla de usos

G 	 MAX (g)	 (Segundos)
	750 ml 	10-20
	750 ml 	10-20
	 MAX (g)	 (Segundos)
	750 ml 	10-20

Usar el Express Serve

Diagramas de uso e instrucciones de uso

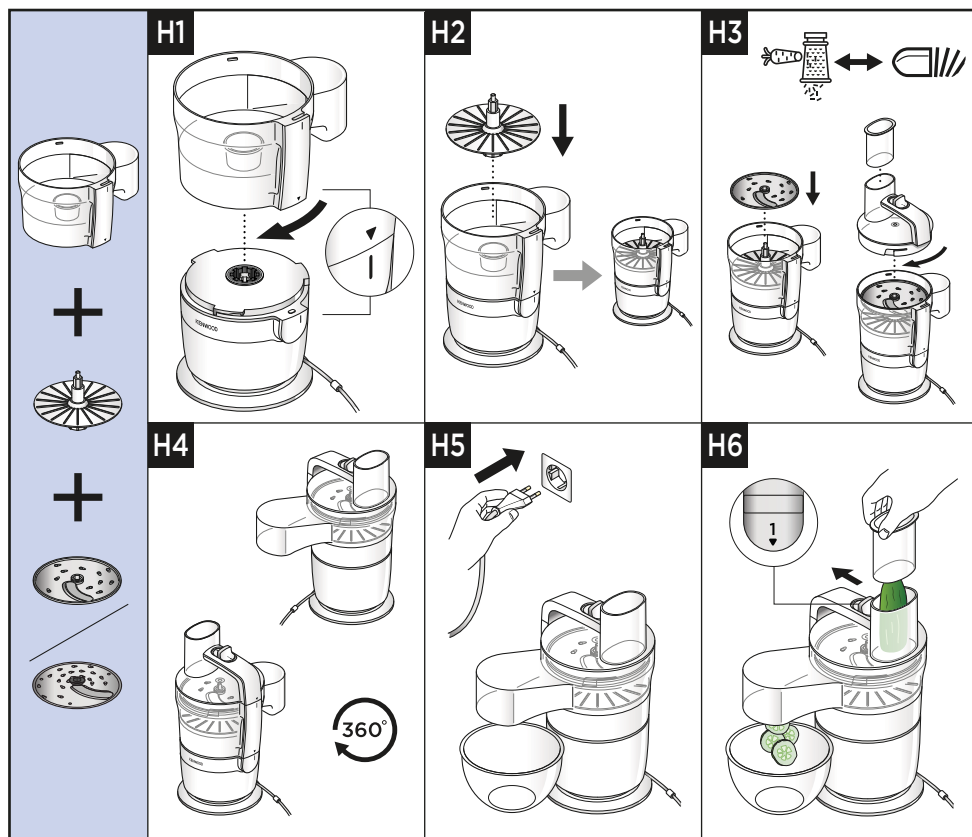











Importante

- No aplique demasiada fuerza al usar el accesorio.
- Si la comida no sale por la salida de alimentos, apague el aparato y compruebe que no haya comida atascada debajo del disco y que la placa de expulsión esté colocada. Quite la comida que haya quedado atrapada antes de seguir procesando los alimentos.

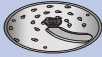
- 1 Coloque el bol sobre la unidad de potencia y gírelo en el sentido de las agujas del reloj para que quede bien sujeto.
- 2 Ponga la placa de expulsión y el disco deseado.
- 3 Ponga la tapa.
- 4 Ponga los alimentos en el tubo de entrada de alimentos.
- 5 Enchufe el aparato, ponga el interruptor a velocidad 1 y empuje de manera uniforme con el empujador.

Tabla de usos

I 	 MAX (g)	 (Segundos)
		120
		120
	 MAX (g)	 (Segundos)
		120

Usar la batidora de vaso personal/picadora

Diagramas de uso e instrucciones de uso

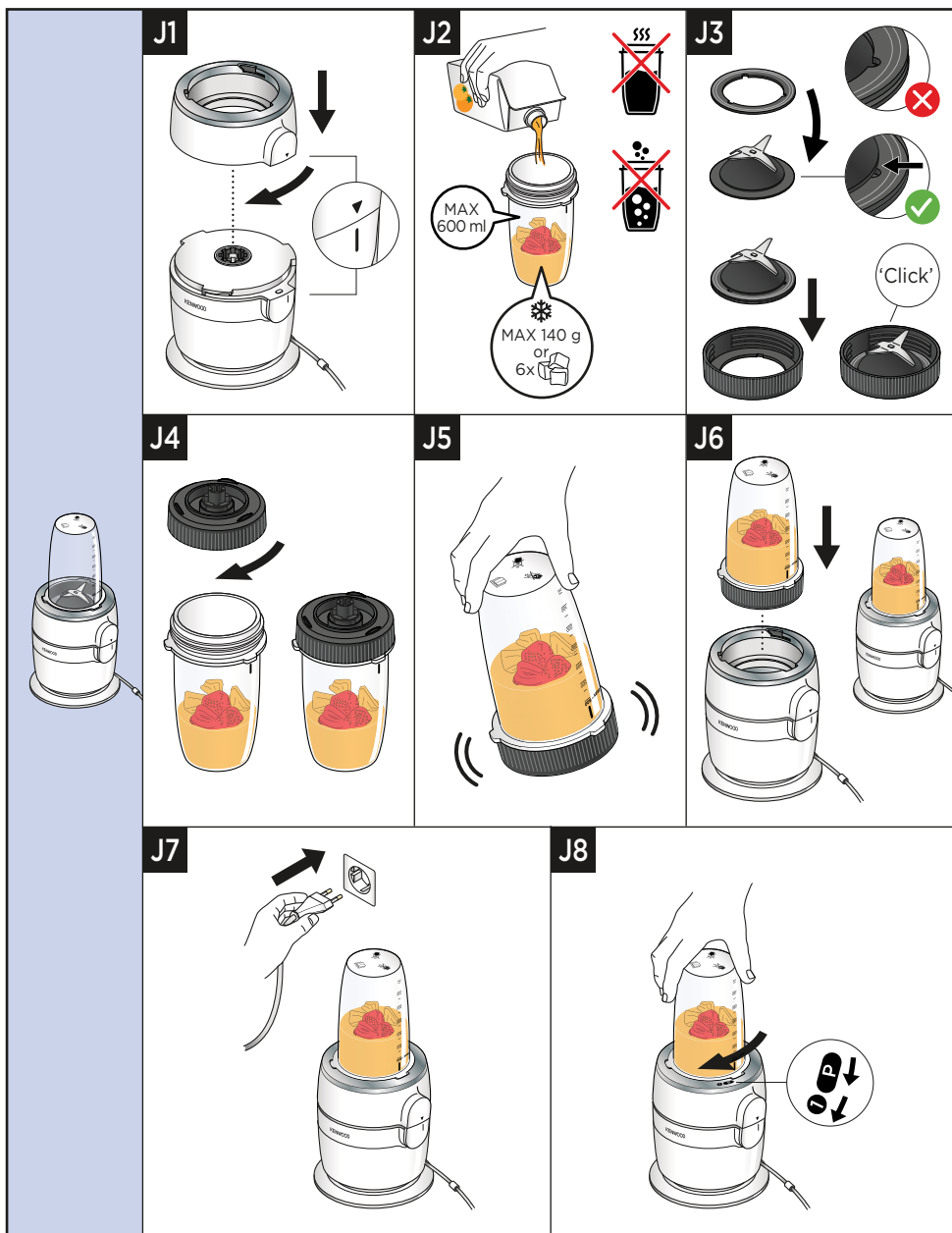

Usar la batidora de vaso personal/picadora

Diagramas de uso e instrucciones de uso

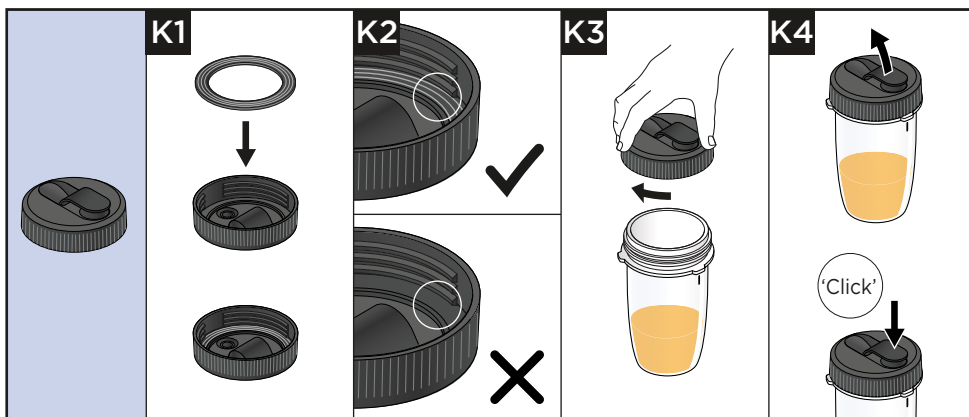

Importante

- La base de la batidora de vaso personal/picadora debe acoplarse a la unidad de potencia antes de colocar la batidora de vaso personal/picadora.
- No mezcle ingredientes congelados sin líquido (excepto cubitos de hielo).
- Si el anillo de cierre está dañado o no está correctamente acoplado, el contenido podría derramarse.
- Nunca bata ingredientes congelados que hayan formado una masa sólida.
- Nunca bata trozos de fruta o verdura congelada que sean más grandes que dados de 3 cm x 3 cm.
- Para un mejor resultado del proceso de mezclado, añada siempre el hielo/los ingredientes congelados a la botella en primer lugar.
- Quite **siempre** los huesos de la fruta deshidratada antes de trocearla.

- 1 Acople la base de la batidora de vaso personal/picadora sobre la unidad de potencia y gírela en el sentido de las agujas del reloj para fijarla en su posición.
- 2 Añada ingredientes al vaso hasta la marca de 600 ml.
- 3 Acople el anillo de cierre a la unidad de cuchillas, asegurándose de que el anillo esté correctamente fijado en la zona ranurada.
- 4 Coloque con cuidado la unidad de cuchillas dentro del portacuchillas y fijela en su posición para que quede bien sujeta.
- 5 Sujete la parte inferior del portacuchillas montado y colóquelo sobre el vaso, con las cuchillas hacia abajo.
- 6 Enrosque el portacuchillas montado en el vaso; gírelo en el sentido de las agujas del reloj para fijarlo en su posición.
- 7 Agite para dispersar los ingredientes.
- 8 Coloque el accesorio sobre la unidad de potencia.

- 9 Enchufe el aparato. Para seleccionar la velocidad del control de acción intermitente, gire el accesorio en el sentido de las agujas del reloj (hacia P) y suéltelo. Para seleccionar la velocidad continua, gire el accesorio en el sentido de las agujas del reloj (hacia 1) hasta que quede bien fijado en su posición.











Tapa para beber

- 10 Acople el anillo de cierre a la tapa para beber, asegurándose de que el anillo esté correctamente fijado en la zona ranurada.
- 11 Para usar la tapa para beber, desenrosque el portacuchillas montado del vaso. Ajuste la tapa para beber girándola en el sentido de las agujas del reloj.
- 12 Cuando quiera beber, sólo tiene que abrir la tapa. La bebida se puede tomar directamente de la botella.
- 13 Después de beber, vuelva a colocar la tapa. Presione firmemente para fijarla.

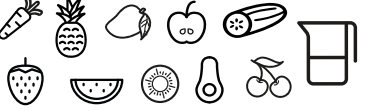
Consejos y sugerencias

- Observe que cuando el vaso se llena hasta la capacidad máxima (600 ml), equivale aproximadamente a dos raciones.
- Si no tiene intención de consumir su bebida inmediatamente, consérvela en la nevera y consúmlala en un plazo de 24 horas.
- Compruebe que su bebida sea lo suficientemente fina como para poder beberla de la tapa dosificadora. Para hacer que una bebida sea menos espesa, añada más líquido.
- Después del mezclado, es posible que algunas bebidas no estén completamente suaves debido a semillas o a la naturaleza fibrosa de los ingredientes.
- Algunas bebidas podrían separarse si reposan, por lo tanto, es mejor beberlas al instante. Las bebidas que se hayan separado deben agitarse antes de beberlas.
- Cuando la tapa para beber esté acoplada, mantenga el vaso siempre en posición vertical.

Tabla de usos

L		 MAX (g)		 (Segundos)
	 3 cm	600 ml	1	30-60
		100 g	10-20	P
		X 6 120-140 g	P	10-20
		50 g	P	10-20
		100 g	1	30-60
		50 g	P	10

Recetas

Pesto

60 g de albahaca fresca
1 diente de ajo
25 g de piñones
25 g de parmesano rallado
110 g de aceite de oliva
Sal al gusto
Pimienta al gusto

- 1 Ponga todos los ingredientes en el vaso de la batidora de vaso/picadora. Pulse el control de acción intermitente 5 veces y, a continuación, siga procesando continuamente hasta alcanzar la consistencia deseada (aproximadamente 25 segundos).

Adobo de ciruela pasa

300 g de miel
40 g de ciruelas pasas
70 ml de agua

- 1 Ponga todos los ingredientes en el vaso de la batidora de vaso/picadora. Consérvelos en el frigorífico durante la noche. (No guarde los ingredientes en el vaso durante más de 24 horas).
- 2 Procese los ingredientes durante 4 segundos usando la velocidad del control de acción intermitente. Úselo inmediatamente.

Ajuste del cable

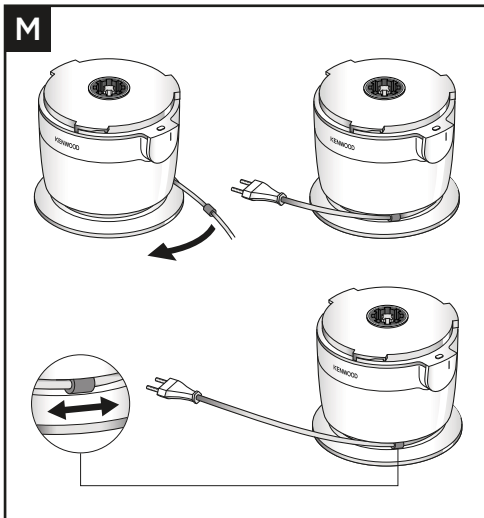

- Enrolle el cable alrededor de la base del procesador a la longitud deseada y sujete el cable con el clip.

Almacenamiento

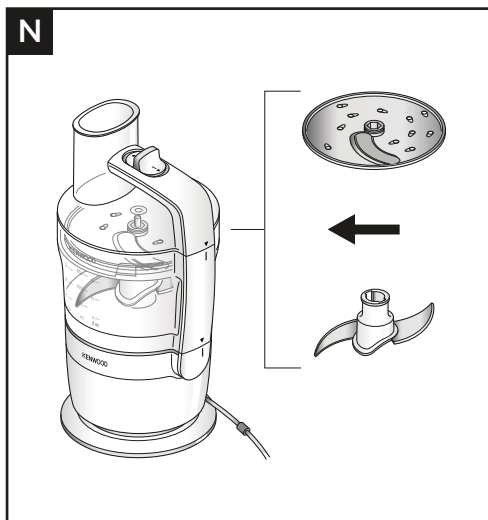

- Después de su uso, la cuchilla y un disco pueden guardarse juntos en el bol.
- El segundo disco (si se incluye) puede guardarse en el bol del Express Serve.
- No haga funcionar el procesador con la cuchilla y un disco colocados los dos a la vez. Use solamente un accesorio a la vez.

Servicio técnico y atención al cliente

- Si tiene problemas con el funcionamiento del aparato, antes de solicitar ayuda, consulte la sección “Guía de solución de problemas” en el manual o visite www.kenwoodworld.com.
- Tenga en cuenta que su producto está cubierto por una garantía que cumple con todas las disposiciones legales relativas a cualquier garantía existente y a los derechos de los consumidores vigentes en el país donde se adquirió el producto.
- Si su producto Kenwood funciona mal o si encuentra algún defecto, envíelo o llévalo a un centro de servicios KENWOOD autorizado. Para encontrar información actualizada sobre su centro de servicios KENWOOD autorizado más cercano, visite www.kenwoodworld.com o la página web específica de su país.
- Diseñado y creado por Kenwood en el Reino Unido.
- Fabricado en China.



ADVERTENCIAS PARA LA CORRECTA ELIMINACIÓN DEL PRODUCTO SEGÚN ESTABLECE LA DIRECTIVA EUROPEA SOBRE RESIDUOS DE APARATOS ELÉCTRICOS Y ELECTRÓNICOS (RAEE)

Al final de su vida útil, el producto no debe eliminarse junto a los desechos urbanos. Puede entregarse a centros específicos de recogida diferenciada dispuestos por las administraciones municipales, o a distribuidores que faciliten este servicio.

Guía de solución de problemas

Problema	Causa	Solución
El procesador no funciona.	No hay corriente.	Compruebe que el procesador esté enchufado.
	El bol no se ha acoplado correctamente en la unidad de potencia.	El procesador no funcionará si el bol o la tapa no están correctamente ajustados en el enclavamiento.
	La tapa del bol no se ha cerrado correctamente.	Compruebe que el bol y la tapa estén alineados y enclavados correctamente.
El procesador se detiene cuando está en marcha.	El procesador está sobrecargado/se han sobrepasado las capacidades máximas.	Revise las capacidades máximas en la Tabla de usos recomendados.
	La tapa no está bien sujeta.	Compruebe que la tapa esté cerrada correctamente.
No se puede acoplar el bol a la base con la tapa colocada.	El interruptor de encendido/apagado está en la posición de encendido "On".	Mueva el interruptor hacia la posición de apagado "Off".
La comida no sale por la salida del Express Serve.	La placa de expulsión no está colocada debajo del disco rebanador/rallador.	Coloque la placa de expulsión.
La comida rebanada o rallada resulta dañada por la cuchilla.	El aparato está funcionando con la cuchilla y el disco colocados en el bol.	Quite la cuchilla antes de usar el disco rebanador/rallador.
Unidad inestable/vibraciones y movimiento fuertes.	La masa se está procesando durante demasiado tiempo. El procesador está sobrecargado/se han sobrepasado las capacidades máximas.	Use el asa de la tapa para sujetar si el aparato empieza a moverse en la superficie de trabajo. No procese masas durante más de 30 segundos seguidos y no sobrepase la cantidad máxima recomendada en la tabla de usos.
	Se está volviendo a amasar la masa.	Vuelva a amasar pero hágalo a mano. No es aconsejable volver a amasar en el bol, ya que esto podría afectar a la estabilidad del aparato.
	Se está procesando fruta/ingredientes pegajosos como dátiles.	Para obtener mejores resultados, use primero la función de acción intermitente "Pulse" para descomponer los ingredientes y luego siga procesando de forma continua.

Guía de solución de problemas

Problema	Causa	Solución
Hay abundantes salpicaduras o los ingredientes salen despedidos del tubo de entrada de alimentos.	El empujador no está colocado.	Acople siempre el empujador al procesar masa, repostería y pasteles para evitar salpicaduras del tubo de entrada de alimentos.
Bajo rendimiento de la cuchilla y el disco.	Consulte la sección “Consejos y sugerencias” y siga las recomendaciones de la tabla de usos.	
La batidora de vaso personal/picadora no funciona.	La batidora de vaso personal/picadora no se ha ajustado correctamente. La base de la batidora de vaso personal/picadora no se ha ajustado correctamente.	La batidora de vaso personal/picadora no funcionará si no está acoplada correctamente en el enclavamiento.
La batidora de vaso personal/picadora gotea por la base del conjunto de cuchillas.	Falta el anillo de cierre. El anillo de cierre no está acoplado correctamente. El anillo de cierre está dañado. El portacuchillas no está completa o correctamente apretado.	Compruebe que el portacuchillas esté bien enroscado. Compruebe que el anillo de cierre esté correctamente colocado dentro de la ranura según el diagrama J3 y que no esté dañado. Para conseguir un anillo de cierre de repuesto, consulte la sección “Servicio técnico y atención al cliente”.
La batidora de vaso personal/picadora gotea por la tapa para beber.	La tapa no está bien cerrada.	Compruebe que la tapa esté bien sujeta.

Català

- Informació important sobre seguretat 171-173
- Informació sobre endolls i fusibles 173
- Cura i neteja 174-175
- Llista de peces 176-177
- Ús del processador d'aliments — Fulla 178-181
 - Diagrames d'ús i instruccions d'ús 178-179
 - Taula d'usos 180
 - Recepta 181
- Ús del processador d'aliments - Discos 181-182
 - Diagrames d'ús i instruccions d'ús 181-182
 - Taula d'usos 182
- Ús de l'Express Serve 183-184
 - Diagrames d'ús i instruccions d'ús 183
 - Taula d'usos 184
- Ús de la batedora de got personal/picadora 185-189
 - Diagrames d'ús i instruccions d'ús 185-187
 - Taula d'usos 188
 - Recepta 189
- Ajustament del cable 189
- Emmagatzematge 190
- Servei tècnic i atenció al client 191
- Guia de resolució de problemes 192-193

Informació important sobre seguretat



- Llegiu atentament aquestes instruccions i conserveu-les per a futures consultes.
- Abans d'utilitzar aquest aparell per primera vegada, traieu tots els embalatges, els fulls publicitaris i les fundes protectores de plàstic de les fulles. Per netejar les peces, consulteu "Cura i neteja".
- Si l'endoll o el cable estan danyats, per raons de seguretat, han de ser substituïts per Kenwood o per un tècnic autoritzat per Kenwood per tal d'evitar possibles riscos.
- **NO toqueu les fulles afilades.** Les fulles i els discos són molt afilats, manipuleu-los amb cura. **Agafeu-los sempre per la nansa a la part superior, lluny de la vora tallant, quan manipuleu les fulles afilades, quan buideu el bol i durant la neteja.**
- **El bol del processador d'aliments i l'Express Serve no són adequats per processar glaçons.**
- Abans d'aixecar o transportar l'aparell per la nansa de la tapa, comproveu sempre que el bol i la tapa estiguin ben fixats al seu lloc.
- **No** processeu ingredients calents en cap dels recipients subministrats, incloent-hi la batedora de got personal. Els líquids calents poden sortir expulsats de l'aparell per una emissió de vapor sobtada.
- **No** deixeu mai l'aparell sense vigilància quan estigui en funcionament.
- **No** mogueu l'aparell mentre estigui en funcionament.
- **No** sobrepassu les capacitats màximes indicades a la taula d'usos recomanats.
- **No feu funcionar l'aparell durant més de 30 segons seguits quan processeu massa sense un període de descans de 5 minuts. Si el feu servir de manera contínua durant períodes de temps més llargs, podeu danyar l'aparell.**
- Traieu **sempre** la fulla i els discos abans d'abocar el contingut del bol del processador d'aliments.
- Mantingueu les mans i els estris fora del bol del processador d'aliments mentre estigui connectat a la font d'alimentació.
- Si cal empènyer els aliments cap avall al bol del processador d'aliments, feu servir un estri adequat com ara una espàtula.
- **No** utilitzeu mai els dits per empènyer els aliments cap avall pel tub d'alimentació. Utilitzeu sempre l'empenyedor subministrat.
- Apagueu **sempre** l'aparell i desconnecteu-lo de la font d'alimentació si el deixeu sense vigilància i abans de muntar-lo, desmuntar-lo o netejar-lo.
- **AVÍS:** Abans de treure la tapa del bol, espereu fins que l'accessori o les fulles s'hagin aturat completament.
- **No** feu servir una força excessiva per empènyer els aliments pel tub d'alimentació, ja que podríeu danyar l'aparell.
- **No** feu servir el bloqueig de la tapa per fer funcionar el processador, utilitzeu sempre el control de velocitat d'encesa/apagada.
- **No** feu funcionar el processador amb la fulla i un disc col·locats tots dos alhora. Feu servir només un accessori alhora.
- **Aquest aparell s'espantillarà i pot causar lesions si el mecanisme d'enclavament se sotmet a una força excessiva.**

- **No** utilitzeu mai un accessori no autoritzat.
- **No** utilitzeu mai un aparell danyat. Feu-lo revisar o reparar: consulteu “Servei tècnic i atenció al client”.
- **No** deixeu que la unitat de potència, el cable o l'endoll es mullin.
- **No** deixeu que l'excés de cable quedi penjant de la taula o taulell ni que toqui superfícies calentes.
- Cal vigilar els nens per assegurar-se que no juguin amb l'aparell.
- Aquest aparell no el poden fer servir els nens. Mantingueu l'aparell i el cable fora de l'abast dels nens.
- Aquest aparell el poden fer servir persones amb capacitats físiques, sensorials o mentals reduïdes o manca d'experiència i coneixements sempre que estiguin supervisats o hagin rebut instruccions sobre l'ús segur de l'aparell i comprenguin els perills a què s'exposen.
- Utilitzeu l'aparell només per a l'ús previst. Kenwood no assumirà cap responsabilitat si l'aparell es fa servir per a un ús inadequat o si no se segueixen aquestes instruccions.
- Un mal ús de l'aparell pot provocar lesions.

Express Serve

- Eviteu el contacte amb les peces mòbils. Mantingueu els dits fora de l'obertura de sortida d'aliments.
- **No** feu funcionar l'aparell sense que la placa d'expulsió estigui acoblada. **Si la placa d'expulsió no està acoblada, el menjar s'embossarà sota el disc i no sortirà per la sortida d'aliments, la qual cosa podria danyar l'accessori.**
- Si el menjar no surt per la sortida d'aliments, apagueu l'aparell i comproveu que no hi hagi menjar embossat sota el disc i que la placa d'expulsió estigui acoblada. Traieu el menjar que hagi quedat atrapat abans de seguir processant els aliments.
- **No feu servir l'Express Serve durant més de 2 minuts seguits. Deixeu que es refredi durant 2 minuts entre cada funcionament de 2 minuts.**

Seguretat de la batidora de got personal/picadora

-  **NO** processeu ingredients calents.
-  **NO** barregeu líquids gasosos.
- **RISC DE CREMADES:** cal deixar que els ingredients calents es refredin a temperatura ambient abans de posar-los al got o abans de barrejar-los.
- No guardeu els ingredients al got durant més de 24 hores.
- Aneu **sempre** amb compte a l'hora de manipular el conjunt de fulles i eviteu tocar la vora tallant de les fulles durant la neteja.
- **No** feu servir **mai** la batidora de got/picadora buida.
- Elaboració de smoothies: no barregeu mai ingredients congelats que hagin format una massa sòlida durant la congelació; trossegeu-los abans d'afegir-los al got.
- Utilitzeu el got únicament amb el conjunt de fulles subministrat.
- **No** begueu **mai** cap líquid calent del got.
- Quan begueu per la tapa, comproveu que la beguda sigui homogènia. Potser calgui fer alguns experiments per aconseguir el resultat desitjat, especialment quan es processen aliments fermes o verds, ja que alguns ingredients poden quedar sense processar.

- **No** barregeu ingredients congelats sense líquid (excepte glaçons).
- **No** tritureu mai trossos de fruita o verdura congelada que siguin més grans que daus de 3 cm x 3 cm.
- **No** barregeu **mai** ingredients secs (p. ex., espècies o fruites seques) ni feu funcionar la batidora de got/picadora quan estigui buida.
- **No** acobieu **mai** el conjunt de fulles a la unitat de potència sense que el got estigui col·locat
- Traieu **sempre** els pinyols de la fruita deshidratada abans de trossejar-la.

Consum d'energia

- Quan l'aparell no està en funcionament
 - Canvi automàtic al mode apagat: no aplicable.
 - Potència del mode apagat: $\leq 0,3$ W.

Informació sobre endolls i fusibles

- Comproveu que el voltatge que figura a la part inferior de la unitat de potència correspongui al voltatge de la vostra xarxa.
- Aquest aparell compleix el Reglament (CE) 1935/2004 sobre els materials i objectes destinats a entrar en contacte amb aliments.











Abans d'utilitzar l'aparell per primera vegada

- 1 Traieu la funda protectora de plàstic de la fulla. Aneu amb compte, ja que les fulles són molt afilades. No guardeu la funda protectora, ja que només es fa servir per protegir la fulla durant el procés de fabricació i el transport.
- 2 Per netejar les peces, consulteu "Cura i neteja".

Cura i neteja

			
	X	X	✓
	✓	✓	X
	✓	✓	X
	✓	✓	X
	✓	✓	X
	✓	✓	X
	✓	✓	X
	✓	✓	X
	✓	✓	X

Cura i neteja

○			
	X	X	✓
	✓	✓	X
	✓	✓	X
	✓	✓	X
	✓	✓	X
	✓	✓	X
	✓	✓	X

- Apagueu l'aparell, espereu fins que l'accessori/les fulles s'hagin aturat i desendolieu-lo abans de netejar-lo.
- Netegeu la unitat de potència amb un drap humit i després eixugueu-la bé. Assegureu-vos que l'àrea d'enclavament estigui lliure de restes de menjar.
- No submergiu la unitat de potència en aigua.
- Manipuleu les fulles i els discos de tall amb cura, ja que són molt afilats.
- Si renteu les fulles de la batidora de got personal/picadora a mà, s'han de netejar amb un raspall i esbandir-se sota l'aigua corrent.

Lista de peces

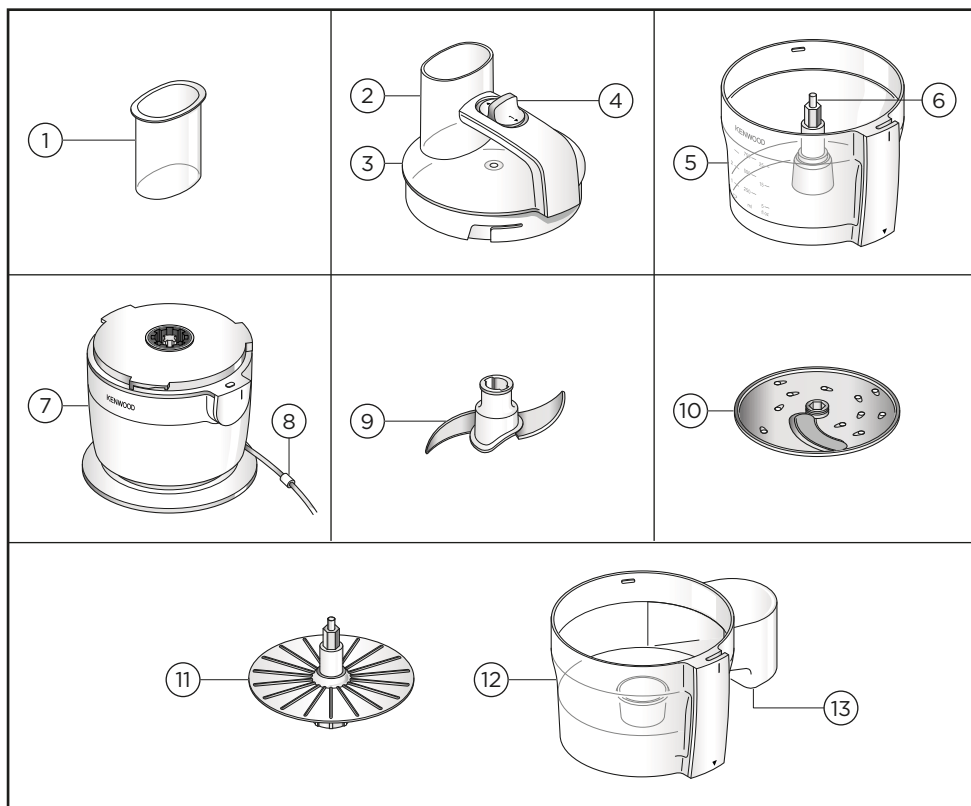

Si s'hi inclou

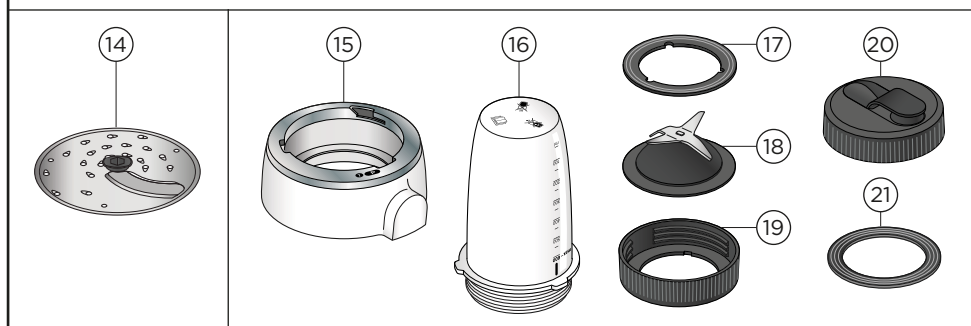

Descripció de l'aparell

Processador d'aliments

- ① Empenyedor
- ② Tub d'alimentació
- ③ Tapa
- ④ Interruptor d'encesa/apagada + Pulse (control per generar impulsos curts)
- ⑤ Bol
- ⑥ Eix motor integrat al bol
- ⑦ Unitat de potència
- ⑧ Clip del cable
- ⑨ Fulla
- ⑩ Disc tallador/ratllador de 4 mm

Express Serve

- ⑪ Placa d'expulsió
- ⑫ Bol de l'Express Serve
- ⑬ Sortida d'aliments

Disc

- ⑭ Disc tallador/ratllador de 2 mm (si s'hi inclou)

Batedora de got personal/picadora

- ⑮ Base de la batedora de got personal/picadora
- ⑯ Got
- ⑰ Anell de segellat
- ⑱ Unitat de fulles
- ⑲ Portafulles
- ⑳ Tapa per beure
- ㉑ Anell de segellat de la tapa per beure

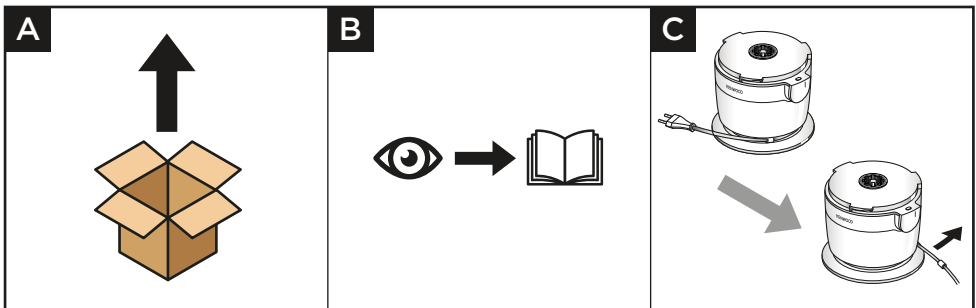

Ús del processador d'aliments - Fulla

Diagrames d'ús i instruccions d'ús

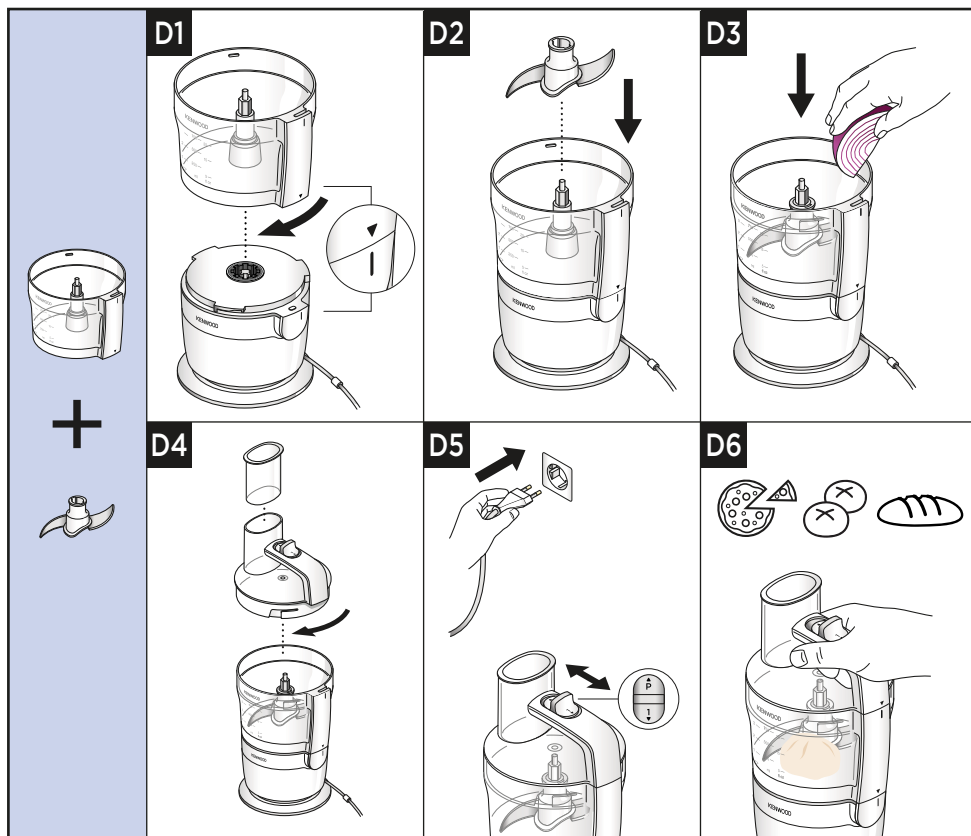

Important

































- El processador no és adequat per triturar o moldre grans de cafè i espècies, convertir sucre granulat en sucre llustre ni per processar glaçons.
- Si afegiu essència d'ametlla o aromatitzants a les barreges, eviteu el contacte amb el plàstic, ja que hi podrien quedar taques permanents.
- Acobleu sempre el bol i l'accessori al processador abans d'afegir-hi qualsevol ingredient.
- No utilitzeu la tapa per fer funcionar el processador.
- El processador no funcionarà si el bol o la tapa no estan acoblats correctament dins de l'enclavament. Comproveu que el tub d'alimentació i la nansa del bol estiguin situats cap al cantó dret de la part davantera.
- Apagueu i desendolceu sempre l'aparell abans de treure la tapa.
- Massa de pa, no processeu els ingredients durant més de 30 segons seguits.
- Torneu a pastar la massa de pa, però feu-ho a mà. No és aconsellable tornar a pastar al bol, ja que això podria afectar l'estabilitat de l'aparell.
- Subjecteu sempre la unitat per la nansa quan processeu massa.

- 1 Poseu el bol sobre la unitat de potència i gireu-lo en el sentit de les agulles del rellotge perquè quedi ben fixat.
- 2 Poseu la fulla sobre l'eix motor.
- 3 Afegiu els ingredients al bol del processador d'aliments.
- 4 Acobleu la tapa.
- 5 Endolleu la unitat a la xarxa elèctrica.
- 6 Enceneu la unitat o feu servir la funció Pulse.

Consells i suggeriments

- Useu el control Pulse (P) per generar impulsos curts. El control Pulse funcionarà mentre es mantingui premut.
- Alguns aliments poden tacar el plàstic. Això és totalment normal i no perjudicarà el plàstic ni afectarà el sabor dels aliments. Per eliminar les taques, fregueu el plàstic amb un drap suau mullat en oli vegetal.
- **Massa de pa** - Poseu primer els ingredients secs al bol i després afegiu-hi el líquid. Processeu els ingredients fins a obtenir una bola de massa elàstica i homogènia.
- Feu servir la nansa de la tapa per subjectar l'aparell si comença a moure's al taulell.
- Per obtenir textures més gruixudes, utilitzeu el control Pulse.
- Tingueu cura de no processar els ingredients excessivament.
- Per fer pasta de full, utilitzeu mantega acabada de treure del frigorífic i tallada a daus de 2 cm.

Taula d'usos

E	 MÀX (g)	 (segons)
	20-30	10-20
	200	30
	150	20-30
	  2 cm	300
	  1/4	200
	  2-3 cm	250
	  2 cm	100-200
	400	60
	x3  + 300 ml 	45-60
	250 g  + 150 g 	30
	250 g 	10-30
	 x3 +  150 g +  150 g ^{18-22° C}  +  150 g	20

Recepta

Adob de pruna seca

400 g de mel
40 g de prunes seques
50 ml d'aigua

- 1 Conserveu els ingredients al frigorífic durant la nit.
- 2 Processeu-los durant 4 segons mitjançant el control Pulse.

Ús del processador d'aliments - Discos

Diagrames d'ús i instruccions d'ús

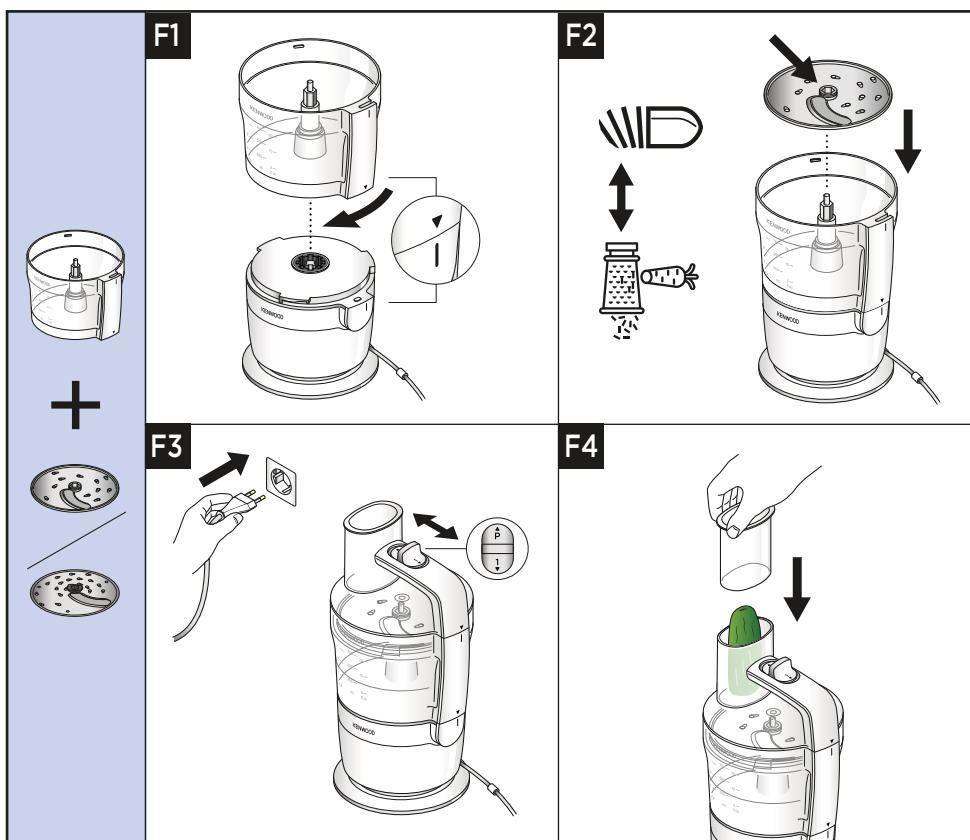

Important











- No fiquen mai els dits al tub d'alimentació.

- 1 Poseu el bol sobre la unitat de potència i gireu-lo en el sentit de les agulles del rellotge perquè quedi ben fixat.
- 2 Agafeu el disc per la part central i poseu-lo sobre l'eix motor amb el costat apropiat cap amunt.
- 3 Acoblegu la tapa.
- 4 Poseu els aliments al tub d'alimentació.
- 5 Endollegu l'aparell, poseu l'interruptor a velocitat 1 i empenyeu cap avall de manera uniforme amb l'empenyedor.

Consells i suggeriments

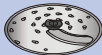
- Utilitzeu ingredients frescos.
- No tallegu els aliments en trossos massa petits. Ompliu el tub d'alimentació gairebé fins a dalt amb els ingredients (evitant que quedin massa atapeïts); això evitarà que els aliments llisquin cap als costats durant el processament.
- Quan tallegu o ratllegu, els aliments col·locats en sentit vertical surten més curts que els que es col·loquen en sentit horitzontal.
- Després de processar els aliments, sempre quedaran petites restes de menjar al disc o al bol.

Taula d'usos

G 	 MÀX (g)	 (segons)
	750 ml 	10-20
	750 ml 	10-20
	 MÀX (g)	 (segons)
	750 ml 	10-20

Ús de l'Express Serve

Diagrames d'ús i instruccions d'ús

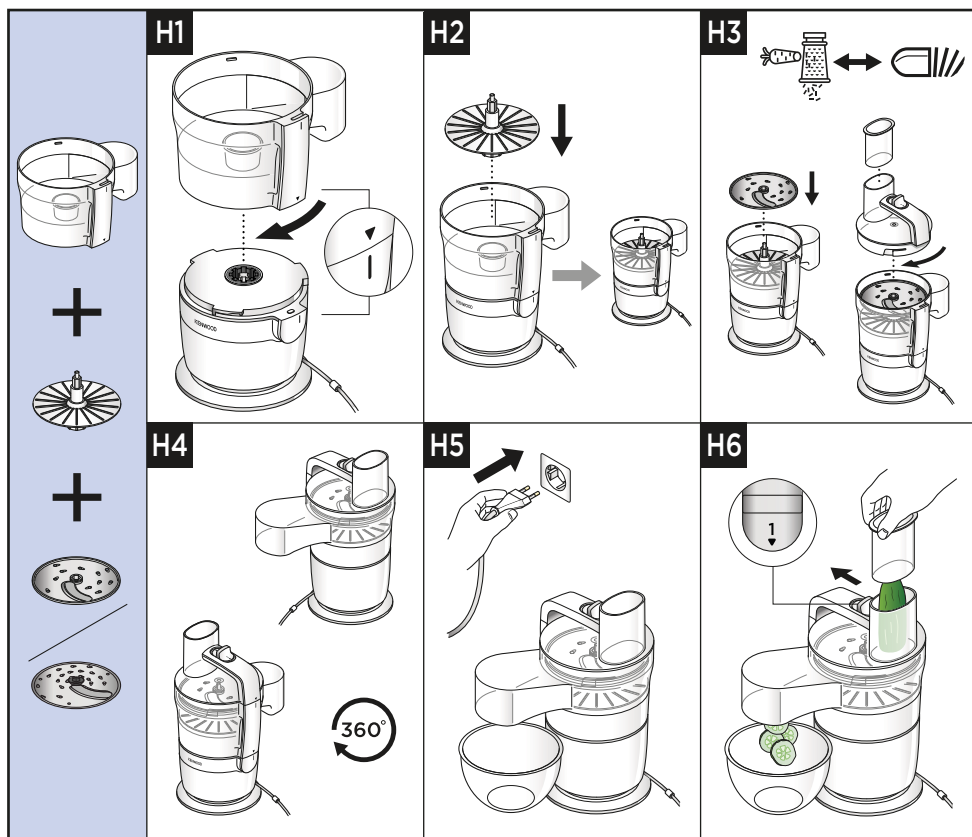











Important

- No apliqueu una força excessiva quan utilitzeu l'accessori.
- Si el menjar no surt per la sortida d'aliments, apagueu l'aparell i comproveu que no hi hagi menjar embossat sota el disc i que la placa d'expulsió estigui acoblada. Traieu el menjar que hagi quedat atrapat abans de seguir processant els aliments.

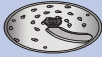
- 1 Poseu el bol sobre la unitat de potència i gireu-lo en el sentit de les agulles del rellotge perquè quedi ben fixat.
- 2 Poseu la placa d'expulsió i el disc desitjat.
- 3 Acobieu la tapa.
- 4 Poseu els aliments al tub d'alimentació.
- 5 Endolieu l'aparell, poseu l'interruptor a velocitat 1 i empenyeu cap avall de manera uniforme amb l'empenyedador.

Taula d'usos

I 	 MÀX (g)	 (segons)
		120
		120
	 MÀX (g)	 (segons)
		120

Ús de la batedora de got personal/picadora

Diagrames d'ús i instruccions d'ús

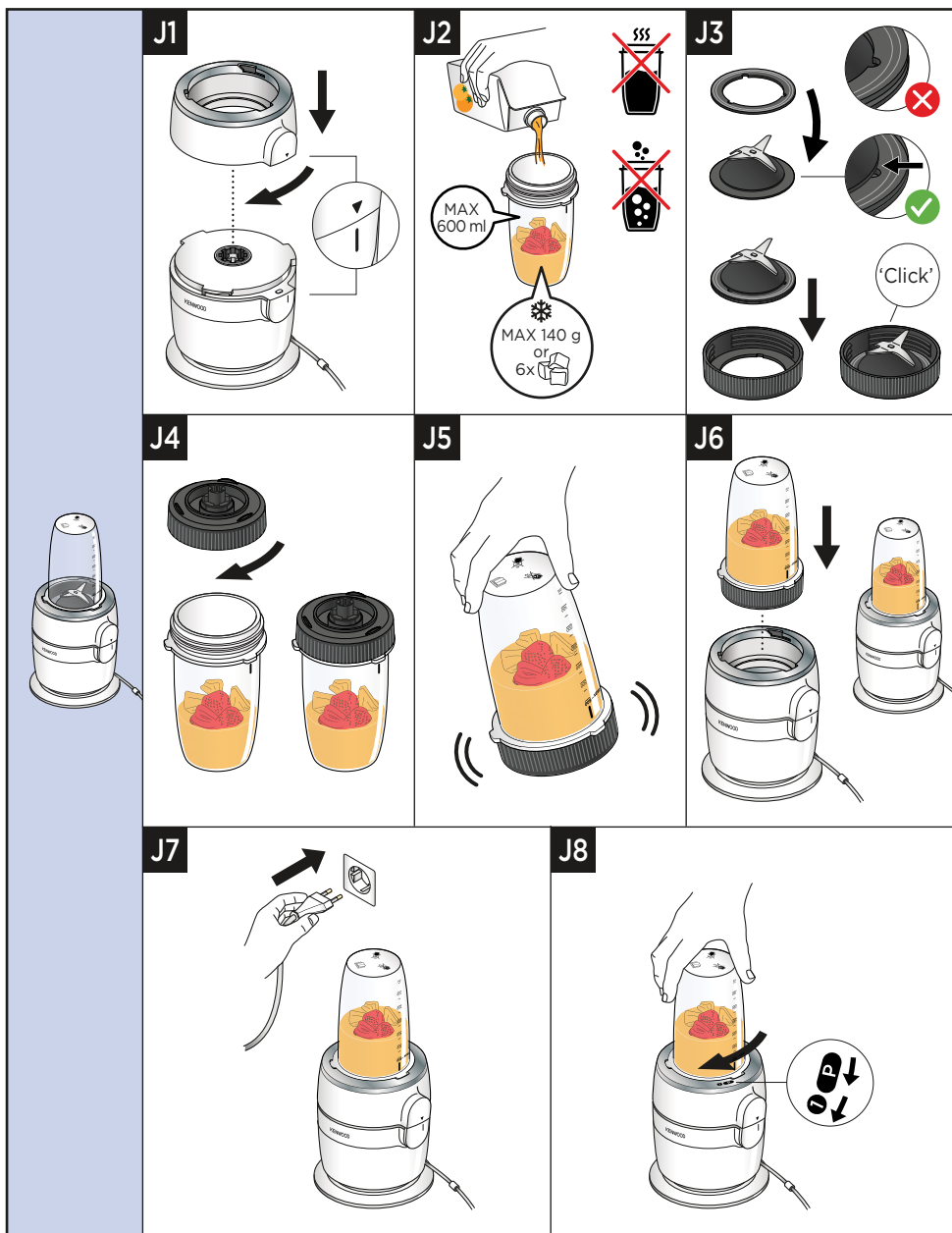

Ús de la batedora de got personal/picadora

Diagrames d'ús i instruccions d'ús

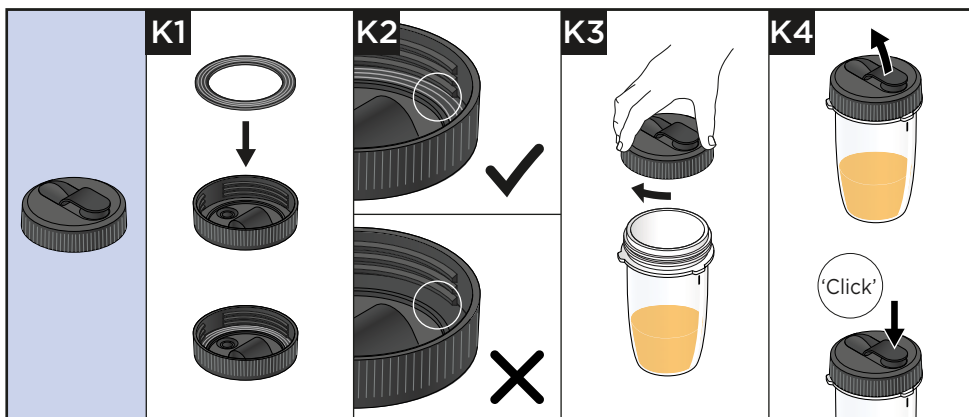

Important

- La base de la batedora de got personal/picadora s'ha d'acoblar a la unitat de potència abans de col·locar la batedora de got personal/picadora.
- No barregeu ingredients congelats sense líquid (excepte glaçons).
- Si l'anell de segellat està danyat o no està correctament acoblat, el contingut podria degotar.
- No barregeu mai ingredients congelats que hagin format una massa sòlida.
- No tritureu mai trossos de fruita o verdura congelada que siguin més grans que daus de 3 cm x 3 cm.
- Per a un millor resultat del procés de barreja, afegiu sempre el gel/els ingredients congelats a l'ampolla en primer lloc.
- Traieu **sempre** els pinyols de la fruita deshidratada abans de trossejar-la.

- 1 Acobleeu la base de la batedora de got personal/picadora a la unitat de potència i gireu-la en el sentit de les agulles del rellotge perquè quedi ben fixada.
- 2 Afegiu els ingredients al got fins a la marca de 600 ml.
- 3 Acobleeu l'anell de segellat a la unitat de fulles i assegureu-vos que l'anell estigui correctament fixat a la zona ranurada.
- 4 Col·loqueu amb compte la unitat de fulles dins del portafulles i fixeu-la al seu lloc perquè quedi ben subjecta.
- 5 Subjecteu la part inferior del portafulles muntat i col·loqueu-lo sobre el got, amb les fulles cap avall.
- 6 Enrosqueu el portafulles muntat sobre el got; gireu-lo en el sentit de les agulles del rellotge perquè quedi ben fixat.
- 7 Agiteu per dispersar els ingredients.
- 8 Col·loqueu l'accessori sobre la unitat de potència.

- 9 Endolleu l'aparell. Per seleccionar la velocitat Pulse, gireu l'accessori en el sentit de les agulles del rellotge (cap a P) i allibereu-lo. Per seleccionar la velocitat contínua, gireu l'accessori en el sentit de les agulles del rellotge (cap a 1) fins que quedi ben fixat al seu lloc.











Tapa per beure

- 10 Acobieu l'anell de segellat a la tapa per beure i assegureu-vos que l'anell estigui correctament fixat a la zona ranurada.
- 11 Per utilitzar la tapa per beure, desenrosqueu el portafulles muntat del got. Ajusteu la tapa per beure girant-la en el sentit de les agulles del rellotge.
- 12 Quan vulgueu beure, només heu d'obrir la coberta de la tapa. La beguda es pot beure directament de l'ampolla.
- 13 Després de beure, torneu a posar tapa. Premeu fermament per fixar-la.

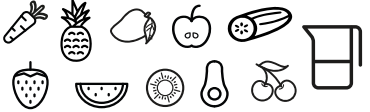
Consells i suggeriments

- Tingueu en compte que quan el got s'omple fins a la capacitat màxima (600 ml), equival aproximadament a dues racions.
- Si no teniu previst consumir la beguda immediatament, conserveu-la al frigorífic i consumiu-la en un termini de 24 hores.
- Comproveu que la vostra beguda sigui prou fina per poder-la beure de la tapa dosificadora. Per fer que una beguda sigui més fina, afegiu-hi més líquid.
- Després de la barreja, és possible que algunes begudes no siguin completament homogènies a causa de les llavors o la naturalesa fibrosa dels ingredients.
- Algunes begudes poden separar-se si reposen, per tant, és millor beure-les de seguida. Les begudes que s'hagin separat s'han de remenar abans de beure-les.
- Quan la tapa per beure estigui acoblada, mantingueu sempre el got en posició vertical.

Taula d'usos

L		 MAX (g)		 (segons)
	 3 cm	600 ml	1	30-60
		100 g	10-20	P
		X 6 120-140 g	P	10-20
		50 g	P	10-20
		100 g	1	30-60
		50 g	P	10

Recepta

Pesto

60 g d'alfàbrega fresca
1 gran d'all
25 g de pinyons
25 g de parmesà ratllat
110 g d'oli d'oliva
Sal al gust
Pebre al gust

- 1 Poseu tots els ingredients al got de la batedora de got/picadora. Premeu el control Pulse 5 vegades i, a continuació, processeu contínuament fins assolir la consistència desitjada (aproximadament 25 segons).

Adob de pruna seca

300 g de mel
40 g de prunes seques
70 ml d'aigua

- 1 Poseu tots els ingredients al got de la batedora de got/picadora. Conserveu els ingredients al frigorífic durant la nit. (No guardeu els ingredients al got durant més de 24 hores.).
- 2 Processeu-los durant 4 segons mitjançant el control Pulse. Utilitzeu-lo immediatament.

Ajustament del cable

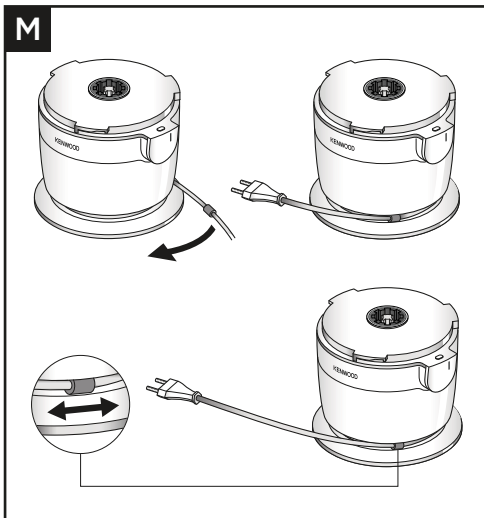

- Enrotlleu el cable al voltant de la base del processador fins a la longitud desitjada i subjecteu el cable amb el clip.

Emmagatzematge

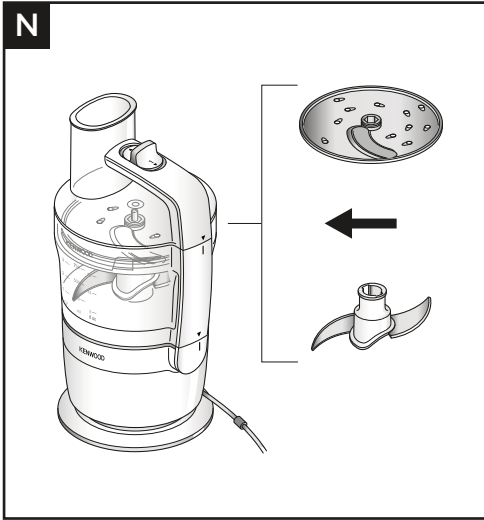

- Després de l'ús, la fulla i un disc es poden emmagatzemar junts al bol.
- El segon disc (si s'hi inclou) es pot guardar al bol de l'Express Serve.
- No feu funcionar el processador amb la fulla i un disc col·locats tots dos alhora. Feu servir només un accessori alhora.

Servei tècnic i atenció al client

- Si teniu cap problema amb el funcionament del vostre aparell, abans de sol·licitar assistència, consulteu la secció "Guia de resolució de problemes" del manual o visiteu www.kenwoodworld.com.
- Tingueu en compte que el vostre producte està cobert per una garantia que compleix totes les disposicions legals relatives a qualsevol garantia existent i als drets dels consumidors vigents al país on es va comprar el producte.
- Si el vostre producte Kenwood funciona malament o si trobeu algun defecte, envieu-lo o porteu-lo a un centre de serveis autoritzat de KENWOOD. Per trobar informació actualitzada sobre el vostre centre de serveis autoritzat de KENWOOD més proper, visiteu www.kenwoodworld.com o el lloc web específic del vostre país.
- Dissenyat i creat per Kenwood al Regne Unit.
- Fabricat a la Xina.



INFORMACIÓ IMPORTANT PER A L'ELIMINACIÓ CORRECTA DEL PRODUCTE DE CONFORMITAT AMB LA DIRECTIVA EUROPEA SOBRE RESIDUS D'APARELLS ELÈCTRICS I ELECTRÒNICS (RAEE)

Al final de la seva vida útil, el producte no s'ha de llençar com a residu domèstic. S'ha de dur a un centre especial de recollida diferenciada de residus disposat per l'autoritat local o a un distribuïdor que presti aquest servei.

Guia de resolució de problemes

Problema	Causa	Solució
El processador no funciona.	No hi ha corrent elèctric.	Comproveu que el processador estigui endollat.
	El bol no està correctament acoblat a la unitat de potència.	El processador no funcionarà si el bol o la tapa no estan correctament acoblats en l'enclavament.
	La tapa del bol no s'ha bloquejat correctament.	Comproveu que el bol i la tapa estiguin alineats i enclavats correctament.
El processador s'atura durant el processament.	El processador està sobrecarregat/s'han sobrepassat les capacitats màximes.	Comproveu les capacitats màximes indicades a la taula d'usos recomanats.
	La tapa està desbloquejada.	Comproveu que la tapa estigui bloquejada correctament.
No es pot acoblar el bol a la base amb la tapa col·locada.	L'interruptor d'encesa/apagada està en la posició d'encesa "On".	Moueu l'interruptor a la posició d'apagada "Off".
El menjar no surt per la sortida de l'Express Serve.	La placa d'expulsió no està col·locada sota el disc tallador/ratlador.	Col·loqueu la placa d'expulsió.
La fulla malmet el menjar tallat o ratllat.	L'aparell està funcionant amb la fulla i el disc col·locats tots dos al bol.	Traieu la fulla abans d'utilitzar el disc tallador/ratlador.
Unitat inestable/ vibracions i moviment forts.	La massa s'està processant durant massa temps.	Feu servir la nansa de la tapa per subjectar l'aparell si comença a moure's al taulell.
	El processador està sobrecarregat/s'han sobrepassat les capacitats màximes.	No processeu les masses durant més de 30 segons seguits i no sobrepassu la quantitat màxima recomanada a la taula d'usos.
	S'està tornant a pastar la massa.	Torneu a pastar, però feu-ho a mà. No és aconsellable tornar a pastar al bol, ja que això podria afectar l'estabilitat de l'aparell.
	S'està processant fruita/ ingredients enganxosos com ara dàtils.	Per obtenir millors resultats, feu servir primer el control Pulse per descompondre els ingredients i després seguïu processant-los de manera contínua.

Guia de resolució de problemes

Problema	Causa	Solució
Hi ha moltes esquitxades o els ingredients surten expulsats del tub d'alimentació.	L'empenyedador no està acoblat.	Acobleeu sempre l'empenyedador quan processeu massa, pasta de full i pastissos per evitar esquitxades a través del tub d'alimentació.
Baix rendiment de la fulla i el disc.	Consulteu la secció "Consells i suggeriments" i seguiu les recomanacions de la taula d'usos.	
La batidora de got personal/picadora no funciona.	La batidora de got personal/picadora no s'ha fixat correctament. La base de la batidora de got personal/picadora no s'ha fixat correctament.	La batidora de got personal/picadora no funcionarà si no està acoblada correctament a l'enclavament.
La batidora de got personal/picadora degota per la base del conjunt de fulles.	Hi manca l'anell de segellat. L'anell de segellat no està acoblat correctament. L'anell de segellat està danyat. El portafulles no està completament o ben ajustat.	Comproveu que el portafulles estigui ben cargolat. Comproveu que l'anell de segellat estigui correctament col·locat dins de la ranura segons el diagrama J3 i que no estigui danyat. Per aconseguir un anell de segellat de recanvi, consulteu "Servei tècnic i atenció al client".
La batidora de got personal/picadora degota a través de la tapa per beure.	La tapa està desbloquejada.	Comproveu que la tapa estigui bloquejada correctament.

Dansk

- Vigtig sikkerhedsinformation [195-197](#)
- Før stikket sættes i stikkontakten [197](#)
- Pleje og rengøring [198-199](#)
- Liste over dele [200-201](#)
- Sådan bruger du din foodprocessor – kniv [202-204](#)
 - Brugsdiagrammer og brugsanvisninger [202-203](#)
 - Diagram over anbefalet brug [203](#)
 - Opskrift [204](#)
- Sådan bruger du din foodprocessor – skiver [204-205](#)
 - Brugsdiagrammer og brugsanvisninger [204-205](#)
 - Diagram over anbefalet brug [205](#)
- Sådan bruger du din Express Serve [206-207](#)
 - Brugsdiagrammer og brugsanvisninger [206](#)
 - Diagram over anbefalet brug [207](#)
- Sådan bruger du din personlige blender/hakker [208-212](#)
 - Brugsdiagrammer og brugsanvisninger [208-210](#)
 - Diagram over anbefalet brug [211](#)
 - Opskrifter [212](#)
- Justering af ledning [212](#)
- Opbevaring [213](#)
- Service og kundepleje [214](#)
- Fejlsøgningsguide [215-216](#)

Vigtig sikkerhedsinformation



- Læs denne brugervejledning nøje, og opbevar den i tilfælde af, at du får brug for at slå noget op i den.
- Før første ibrugtagning fjernes al emballage, markedsføringslitteratur og knivafdækningerne i plast. Vask delene: Se 'Pleje og rengøring'.
- Hvis stikket eller ledningen er beskadiget, skal Kenwood eller en autoriseret Kenwood-reparatør af sikkerhedsgrunde stå for udskiftningen for at undgå fare.
- **Rør IKKE ved de skarpe knive.** Knivene og skiverne er meget skarpe og skal håndteres med forsigtighed. **Hold altid fast i fingergrebet øverst, væk fra æggen, ved håndtering af de skarpe knive ved tømning af skålen og under rengøring.**
- **Foodprocessors skål og Express Serve er ikke egnet til bearbejde isterninger.**
- Før apparatet løftes eller bæres i håndtaget på låget, skal det altid kontrolleres, at skålen og låget er forsvarligt låst på plads.
- **Tilbered ikke** varme ingredienser i de medfølgende beholdere, herunder den personlige blender. Varme væsker kan sprøjte ud af apparatet på grund af pludselig fordampning.
- Efterlad **aldrig** apparatet uden opsyn, når det er i drift.
- Apparatet må **ikke** flyttes, mens det er i brug.
- Overskrid **ikke** de angivne maksimummængder i oversigten over anbefalet brug.
- **Lad ikke apparatet køre længere end 30 sekunder uden 5 minutters pause, når der tilberedes dej. Kontinuerlig tilberedning i længere tid kan skade dit apparat.**
- **Fjern altid** knivbladet og skiverne, før du hælder indhold ud af foodprocessorskålen.
- Hænder og redskaber må ikke være i skålen, når der er strøm på.
- Hvis maden skal skubbes ned i foodprocessorskålen, skal du anvende et egnet redskab, f.eks. en spatel.
- Brug **aldrig** fingrene til at stoppe maden ned i påfyldningstragten. Brug altid den medfølgende nedstopper.
- Sluk **altid** for apparatet, og afbryd strømforsyningen, hvis det lades uden opsyn, inden samling, adskillelse eller rengøring.
- **FORSIGTIG:** Inden låget fjernes fra skålen, skal du vente, indtil tilbehøret/knivene står helt stille.
- Brug **ikke** for mange kræfter til at presse maden ned i påfyldningstragten – du kan beskadige apparatet.
- Brug **ikke** lågets lås til at betjene foodprocessoren med, brug altid tænd-/slukfunktionen.
- **Brug ikke** foodprocessoren med både knivbladet og en skive monteret. Brug kun én tilbehørsdel ad gangen.
- **Maskinen bliver beskadiget, og du risikerer selv at komme til skade, hvis du prøver at omgå sikkerhedslåsen med magt.**
- Brug aldrig uoriginalt tilbehør.
- Brug aldrig en defekt maskine. Få den eftersat eller repareret: se under 'Service og kundepleje'.

- Motorhus, ledning eller stik må aldrig blive våde.
- Lad ikke ledningen hænge ned over en bordkant, et skærebæret el.lign. Undgå, at den rører ved varme overflader.
- Børn bør overvåges for at sikre, at de ikke leger med apparatet.
- Dette apparat må ikke anvendes af børn. Opbevar apparatet og ledningen utilgængeligt for børn.
- Apparater kan bruges af personer med reducerede fysiske, sansemæssige eller mentale evner eller mangel på erfaring og kendskab, hvis de er blevet vejledt eller givet instrukser i brugen af apparatet på en sikker måde, og hvis de forstår de farer, der er involveret.
- Anvend kun apparatet til husholdningsbrug. Kenwood påtager sig intet erstatningsansvar, hvis apparatet ikke anvendes korrekt eller disse instruktioner ikke følges.
- Misbrug af køkkenmaskinen kan forårsage skader.

Express Serve

- Undgå kontakt med bevægelige dele. Hold fingrene ude af madudgangens åbning.
- Betjen den ikke uden påsat slyngeplade. **Hvis slyngepladen ikke er påsat, vil mad sætte sig fast under pladen og ikke forlade madvareudgangen, hvilket resulterer i beskadigelse af dit udstyr.**
- Hvis maden ikke kommer ud af madudgangen, skal der slukkes, og det kontrolleres, at maden ikke sidder fast under skiven, samt at slyngepladen er påsat. Fjern eventuelt fastklemt mad, før tilberedningen fortsættes.
- **Lad ikke Express Serve-tilbehøret køre uafbrudt i mere end 2 minutter. Lad det køle af i 2 minutter for hver 2 minutters tilberedning.**

Sikkerhed ved personlig blender/hakker

-  **TILBERED IKKE** varme ingredienser.
-  **BLEND IKKE** væsker med kulsyre.
- **SKOLDNINGSRISIKO:** Varme ingredienser skal køle af til stuetemperatur, før de hældes op i bægeret eller blendes.
- Opbevar ikke ingredienser i bægeret i mere end 24 timer.
- Vær **altid** forsigtig når du håndterer knivenheden og undgå at røre knivens skarpe dele under rengøring.
- **Lad aldrig** blenderen/hakkeren køre, når den er tom.
- Smoothieopskrifter - blend aldrig frosne ingredienser, som har dannet en fast masse under frysningen; del den op, før den fyldes i bægeret.
- Brug kun bægeret med den leverede knivenhed.
- **Drik aldrig** varme væsker fra bægeret.
- Når du drikker gennem låget, skal du sørge for at drikken er jævnt blendet. Det kan være, at der skal lidt øvelse til for at opnå det ønskede resultat, specielt når der bearbejdes faste eller umodne madvarer, da nogle af ingredienserne kan forblive ubehandlede.
- **Du må ikke** blende frosne ingredienser uden væske (undtagen isterninger).
- Du **må aldrig** blende stykker af frossen frugt eller grøntsager, som er større end 3 x 3 cm.
- **Du må aldrig** blende tørre ingredienser (f.eks. krydderier, nødder) eller køre med blenderen/hakkeren, når den er tom.

- **Sæt aldrig** knivenheden på motorenheden uden bægeret monteret.
- **Fjern altid** stenene fra tørret frugt, før den hakkes.

Strømforbrug

- Når apparatet ikke kører
 - Automatisk skift til SLUKKET tilstand: Ikke relevant
 - Strømforbrug i slukket tilstand: $\leq 0,3$ W.

Før stikket sættes i stikkontakten

- Sørg for, at el-forsyningens spænding er den samme som den, der er vist på bunden af maskinen.
- Dette apparat overholder EF-forordning 1935/2004 om materialer og genstande, der kommer i kontakt med levnedsmidler.











Før første ibrugtagning

- 1 Fjern plastafdækningen fra kniven. Pas på, da knivene er meget skarpe. Afdækningen skal kasseres, da den kun skal beskytte kniven under produktion og transport.
- 2 Se "Pleje og rengøring" for oplysninger om vask af delene.

Pløje og rengøring

			
	X	X	✓
	✓	✓	X
	✓	✓	X
	✓	✓	X
	✓	✓	X
	✓	✓	X
	✓	✓	X
	✓	✓	X
	✓	✓	X

Pløje og rengøring

			
	X	X	✓
	✓	✓	X
	✓	✓	X
	✓	✓	X
	✓	✓	X
	✓	✓	X
	✓	✓	X

- Sluk altid for apparatet, og vent, indtil tilbehøret/knivene er stoppet, og tag stikket ud af stikkontakten før rengøring.
- Tør motorenheden af med en fugtig klud, og tør den. Sørg for, at låseområdet er frit for madrester.
- Nedsænk aldrig motorenheden i vand.
- Knivene og skæreskiverne skal håndteres med forsigtighed – de er meget skarpe.
- Hvis du vasker knivene til den personlige blender/hakkeren af i hånden, skal de børstes rene og skylles under rindende vand.

Liste over dele

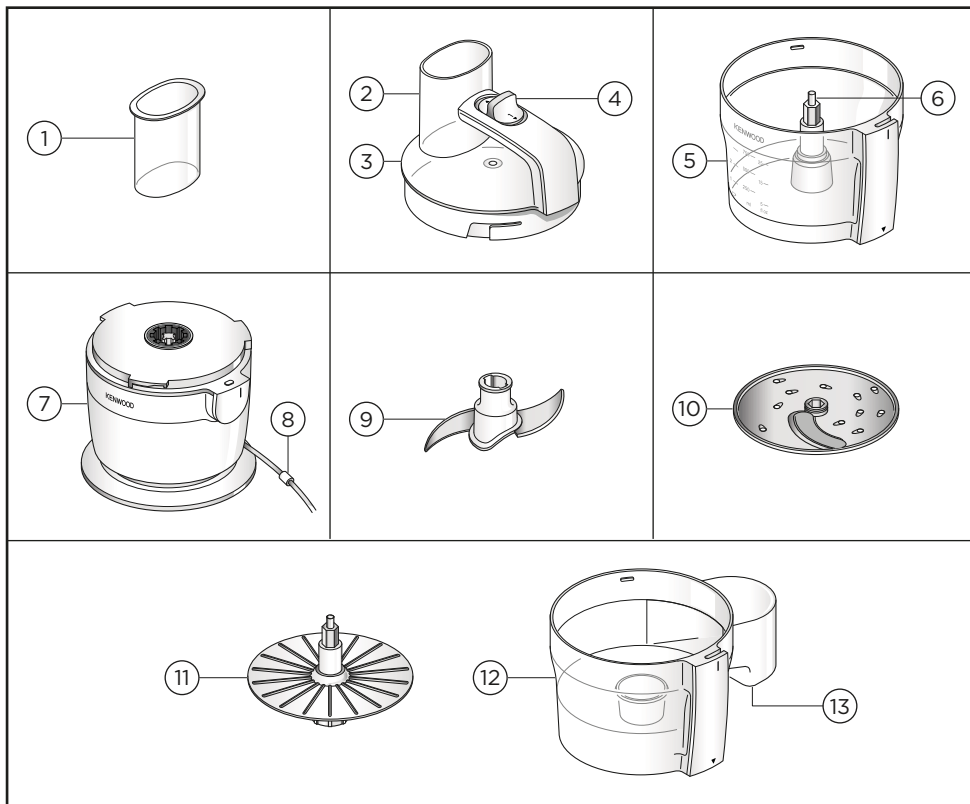

* Hvis en sådan medfølger

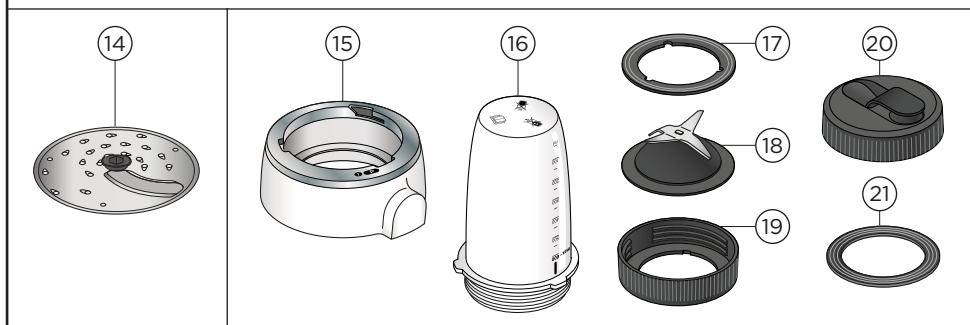

Forklaring

Processor

- ① Nedstoppere
- ② Påfyldningstragt
- ③ Låg
- ④ Tænd-/slukkontakt + impuls
- ⑤ Skål
- ⑥ Drivaksel i skål
- ⑦ Motorenhed
- ⑧ Ledningsclips
- ⑨ Kniv
- ⑩ 4 mm skive til skiveskæring/rivning

Express Serve

- ⑪ Slyngeplade
- ⑫ Express Serve-skål
- ⑬ Madudgang

Disc

- ⑭ 2 mm skive til skiveskæring/rivning (hvis medleveret)

Personlig blender/hakker

- ⑮ Bund til personlig blender/hakker
- ⑯ Bæger
- ⑰ Tætningsring
- ⑱ Knivenhed
- ⑲ Knivholder
- ⑳ Drikkelåg
- ㉑ Tætningsring til drikkelåg

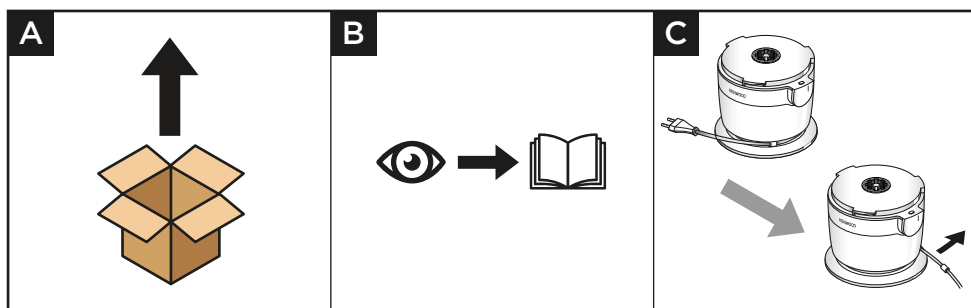

Sådan bruger du din foodprocessor – kniv

Brugsdiagrammer og brugsanvisninger

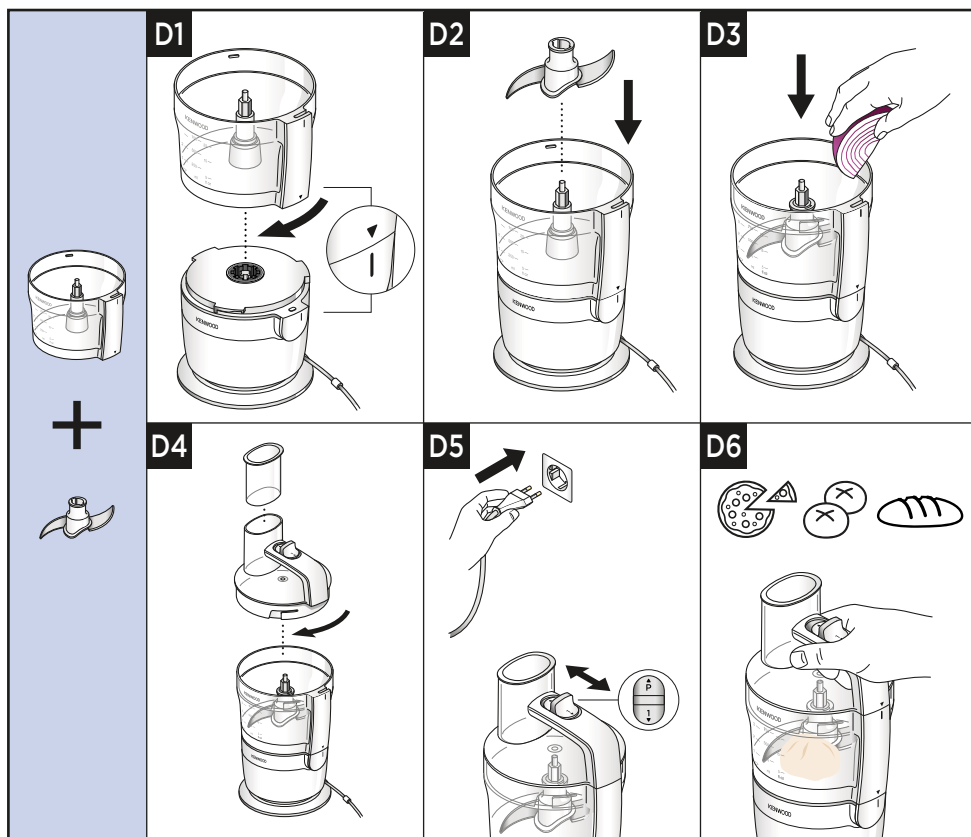

Vigtigt





























- Foodprocessoren egner sig ikke til at knuse eller male kaffebønner og krydderier, til at lave stødt melis til flormelis eller til at bearbejde isterninger.
- Når der tilsættes mandelessens eller krydderier: Undgå, at de kommer i berøring med plastik. Det kan give misfarvning, der ikke kan fjernes.
- Sæt altid skål og tilbehør fast på maskinen, inden der fyldes ingredienser i.
- Du må ikke bruge låget til at betjene processoren.
- Foodprocessoren virker ikke, hvis skålen eller låget ikke sidder korrekt i låsen. Kontrollér, at påfyldningstragten og skålens håndtag er placeret i forreste højre hjørne.
- Sluk altid for maskinen, og træk stikket ud, inden låget fjernes.
- Brøddej må ikke køre i mere end 30 sekunder.
- Dejen må kun æltes med håndkraft. Det anbefales ikke at ælte i skålen, da det kan gøre foodprocessoren ustabil.
- Hold altid enheden i håndtaget, når du bearbejder dej.

- 1 Sæt skålen på motorenheden, og drej med uret for at låse den.
- 2 Sæt kniven på drivakslen.
- 3 Kom ingredienserne op i foodprocessorskålen.
- 4 Sæt låget på.
- 5 Sæt stikket i stikkontakten.
- 6 Tænd for enheden, eller brug impulsfunktionen.

Vink og tips

- Brug impulsfunktionen (P) til korte blendninger. Impulsfunktionen vil være i funktion, så længe kontrolknappen trykkes ned.
- Nogle madvarer kan misfarve plasten. Dette er helt normalt og skader ikke plasten og påvirker ikke madens smag. Gnid den med en klud dyppet i planteolie for at fjerne misfarvningen.
- **Brøddøj** - Kom først de tørre ingredienser i skålen, og tilsæt derefter væsken. Fortsæt tilberedningen, til du har en glat elastisk dejkugle.
- Hold igen i håndtaget på låget, hvis apparatet begynder at flytte sig på køkkenbordet.
- Ønskes en grovere konsistens, kan impulskontrollen bruges.
- Pas på ikke at lade det køre for længe.
- Til bagværk bruges fedtstoffet direkte fra køleskabet skåret i 2 cm tern.

Diagram over anbefalet brug

E		 MAKS. (g)	 (sek.)
		20-30	10-20
		200	30
		150	20-30
	 	300	10/P
	 	200	P
	 	250	15-20
	 	100-200	20
		400	60
		x3  + 300 ml 	45-60
		250 g  + 150 g 	30
		250 g 	10-30
		 x3 +  150 g +  150 g +  18-22°C +  150 g	20

Opskrift

Sveskemarinade

400 g honning

40 g svesker

50 ml vand.

- 1 Opbevares i køleskab natten over.
- 2 Tilbered i 4 sekunder ved hjælp af impulsfunktionen.

Sådan bruger du din foodprocessor – skiver

Brugsdiagrammer og brugsanvisninger

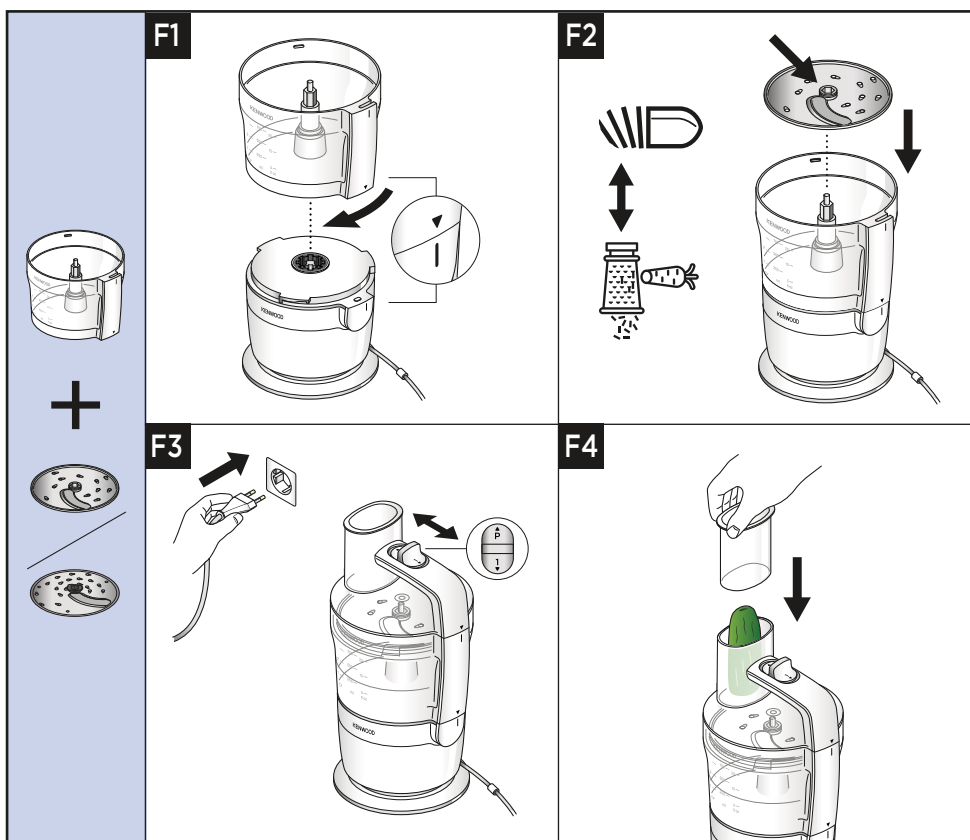

Vigtigt













- Stik aldrig fingrene ned i påfyldningstragten.

- 1 Sæt skålen på motorenheden, og drej med uret for at låse den.
- 2 Hold pladen i grebet i midten, sæt den ned over drivakslen med den ønskede side opad.
- 3 Sæt låget på.
- 4 Maden lægges i påfyldningstragten.
- 5 Sæt stikket i stikkontakten, vælg hastighed 1, og tryk jævnt ned med nedstopperen.

Vink og tips

- Brug friske madvarer.
- Skær ikke maden i for små stykker. Udfyld hele påfyldningstragtens bredde med dine ingredienser (undgå overfyldning), da det forhindrer, at maden smutter ud til siden under bearbejdningen.
- Ingredienser der placeres i lodret position, kommer ud i mindre stykker, end ingredienser der placeres i vandret position.
- Der vil altid sidde en lille mængde mad tilbage på skiven eller i skålen efter tilberedning.

Diagram over anbefalet brug

G		 MAKS. (g)	 (sek.)
		750 ml 	10-20
		750 ml 	10-20
		 MAKS. (g)	 (sek.)
		750 ml 	10-20

Sådan bruger du din Express Serve

Brugsdiagrammer og brugsanvisninger

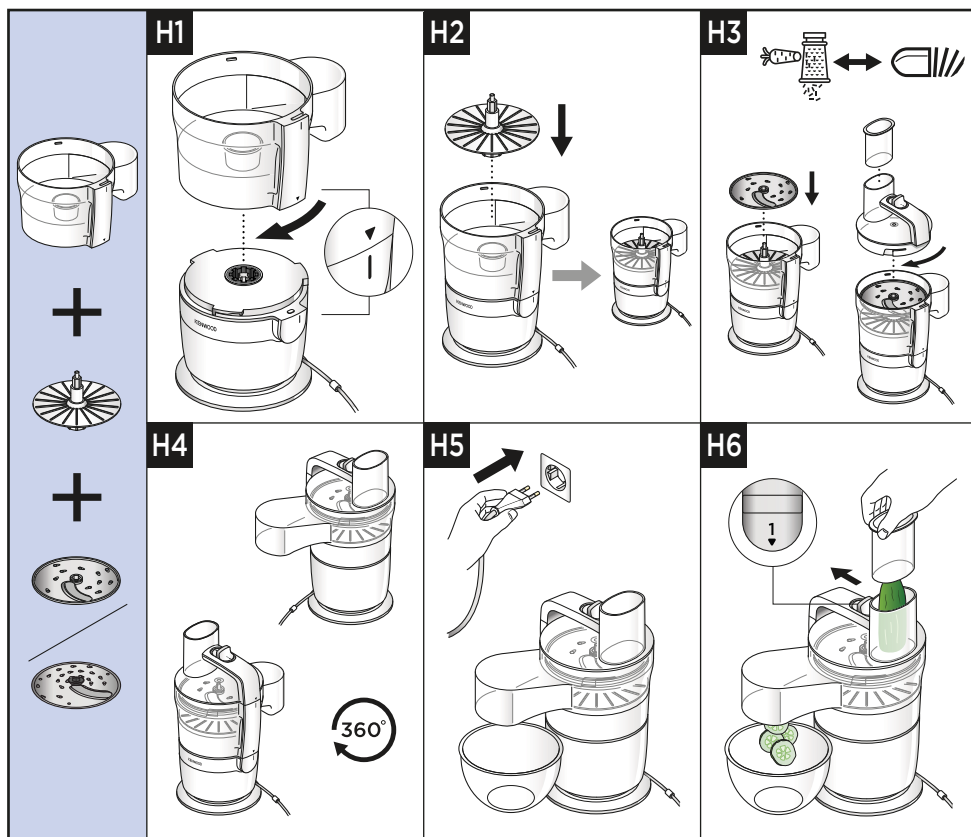













Vigtigt

- Brug ikke overdreven kraft, når redskabet anvendes.
- Hvis maden ikke kommer ud af madudgangen, skal apparatet slukkes, og det skal kontrolleres, at maden ikke sidder fast under skiven, samt at slyngelpladen er påsat. Fjern eventuelt fastklemt mad, før tilberedningen fortsættes.

- 1 Sæt skålen på motorenheden, og drej med uret for at låse den.
- 2 Sæt slyngelpladen og den ønskede skive på.
- 3 Sæt låget på.
- 4 Maden lægges i påfyldningstragten.
- 5 Sæt stikket i stikkontakten, vælg hastighed 1, og tryk jævnt ned med nedstopperen.

Diagram over anbefalet brug

I 	 MAKS. (g)	 (sek.)
		120
		120
	 MAKS. (g)	 (sek.)
		120

Sådan bruger du din personlige blender/hakker

Brugsdiagrammer og brugsanvisninger

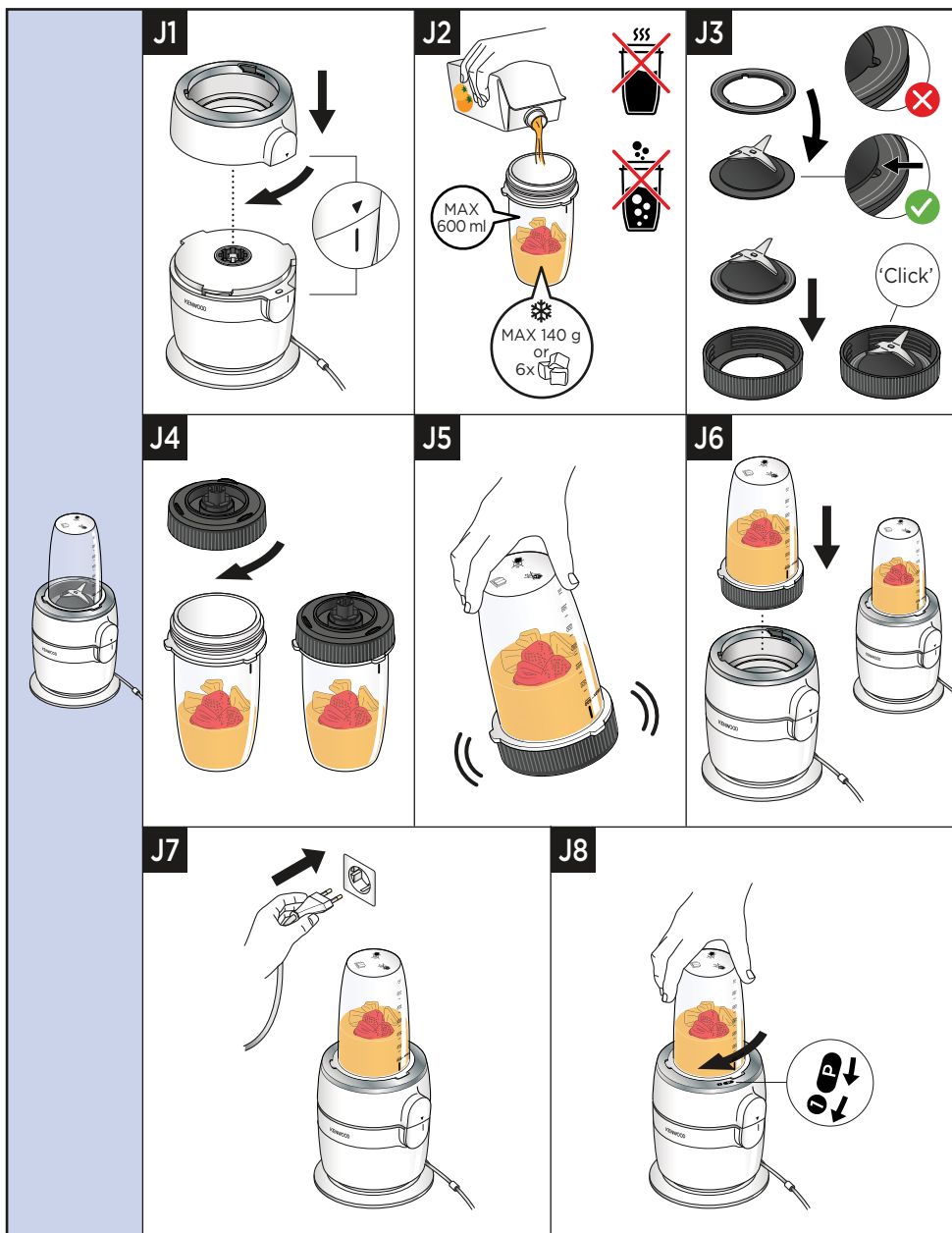

Sådan bruger du din personlige blender/hakker

Brugsdiagrammer og brugsanvisninger

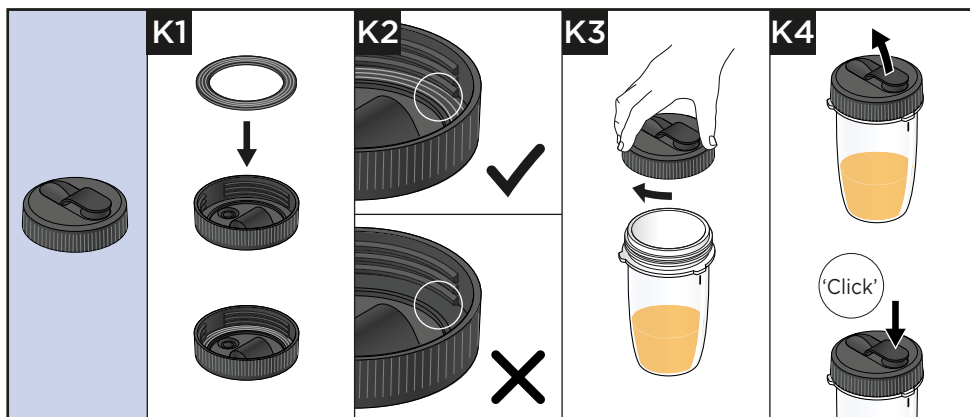

Vigtigt

- Bunden til den personlige blender/hakker skal monteres på motorenheden før den personlige blender/hakker.
- Du må ikke blende frosne ingredienser uden væske (undtagen isterninger).
- Lækage kan forekomme, hvis tætningen er beskadiget eller forkert monteret.
- Blend aldrig frosne ingredienser, som er stivnet til en klump i fryseren.
- Du må aldrig blende stykker af frosnen frugt eller grøntsager, som er større end 3 x 3 cm.
- Du opnår den bedste blanding, hvis du altid lægger is/frosne ingredienser i bægeret først.
- **Fjern altid** stenene fra tørret frugt, før den hakkes.

- 1 Sæt bunden til den personlige blender/hakker på motorenheden, og drej med uret for at låse den.
- 2 Fyld alle ingredienser i bægeret op til 600 ml mærket.
- 3 Sæt tætningsringen ind i knivenheden, og sørg for, at den er sidder sikkert i rillen.
- 4 Sænk forsigtigt knivenheden ned i knivholderen, og klik den på plads.
- 5 Hold på undersiden af den samlede knivholder, og sænk den ned på bægeret med knivene nedad.
- 6 Skru den samlede knivholder på bægeret – drej med uret for at låse.
- 7 Omryst for at sprede ingredienserne.
- 8 Sænk tilbehøret ned på motorenheden.
- 9 Sæt stikket i stikkontakten. Hvis du vil vælge impulshastighed, skal du dreje med uret (mod P) og slippe tilbehøret. Hvis du vil vælge kontinuerlig hastighed, skal du dreje tilbehøret med uret (mod 1), indtil det låser.











Drikkelåg

- 10 Sæt tætningsringen på drikkelåget, og sørg for, at den er sidder rigtigt i rillen.
- 11 Når du vil bruge drikkelåget, skal du skrue den samlede knivholder af bægeret. Sæt drikkelåget på ved at dreje med uret.
- 12 Når du vil drikke, vipper du bare lågdækslet op. Drikken kan drikkes direkte fra bægeret.
- 13 Sæt lågdækslet på igen, når du har drukket. Tryk godt ned for at sætte det fast.

Vink og tips

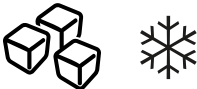
- Bemærk, at når bægeret er fyldt op til maksimal kapacitet (600 ml), er det ca. to portioner.
- Hvis du ikke vil nyde drikken med det samme, skal du holde den nedkølet og drikke den inden for 24 timer.
- Sørg for, at drikken er tynd nok til at drikke af afmålingslåget. Tilsæt mere væske for at fremstille en mere tyndtflydende smoothiedrik..
- Efter blendning er nogle drikke måske ikke helt jævne på grund af kerner eller ingrediensernes fiberindhold.
- Nogle drikke kan skille, når de står. Det er derfor bedst at drikke dem med det samme. Skilte drikke skal omrøres, før de drikkes.
- Når drikkelåget er monteret, skal bægeret altid holdes lodret..

Diagram over anbefalet brug

L		 MAX (g)		 (sek.)
	 3 cm	600 ml	1	30-60
		100 g	10-20	P
		X 6 120-140 g	P	10-20
		50 g	P	10-20
		100 g	1	30-60
		50 g	P	10

Opskrifter

Pesto

60 g frisk basilikum
1 fed hvidløg
25 g pinjekerner
25 g revet parmesan
110 g olivenolie
Salt - efter smag
Peber - efter smag

- 1 Læg alle ingredienser i blenderens/hakkerens bæger. Kør med impuls 5 gange og derefter med kontinuerlig hastighed, indtil du har den ønskede konsistens (ca. 25 sekunder).

Sveskemarkinade

300 g honning
40 g svesker
70 ml vand

- 1 Læg alle ingredienser i blenderens/hakkerens bæger. Sæt i køleskabet natten over. (Opbevar ikke ingredienser i bægeret i mere end 24 timer).
- 2 Kør med impulshastighed i 4 sekunder. Bruges straks.

Justering af ledning

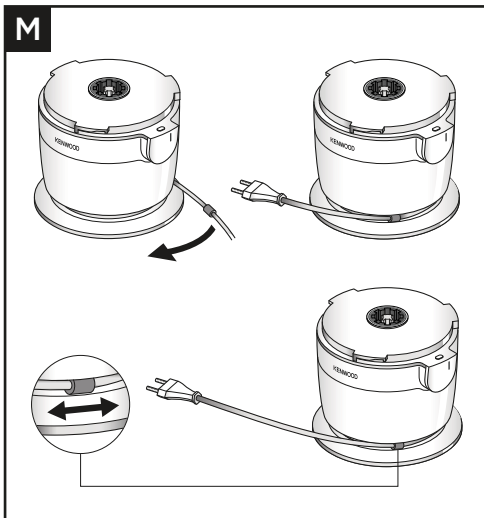

- Rul ledningen om foodprocessorsens bund, til den ønskede længde er nået, og klem ledningen sammen med ledningsklipsen.

Opbevaring

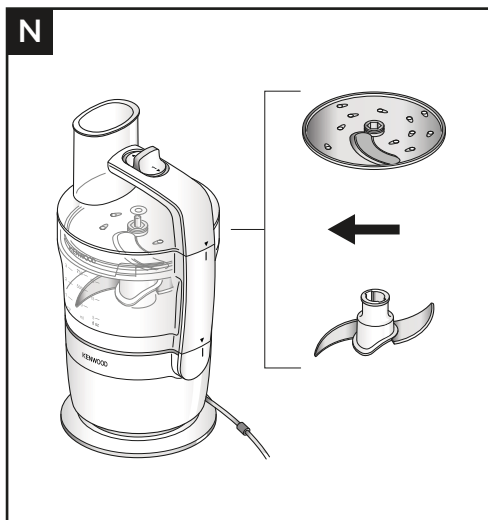

- Efter brug kan kniven og en skive opbevares samlet i skålen.
- Den anden skive (hvis medleveret) kan opbevares i Express Serve-skålen.
- Brug ikke foodprocessoren med både knivbladet og en skive monteret. Brug kun én tilbehørsdel ad gangen.

Service og kundepleje

- Hvis du oplever nogen problemer med betjening af dit apparat, skal du, før du anmoder om hjælp, se afsnittet "Fejlsøgningsguide" i manualen eller besøge www.kenwoodworld.com.
- Bemærk, at dit produkt er dækket af en garanti, som overholder alle lovbestemmelser, vedrørende evt. eksisterende garanti- og forbrugerrettigheder i det land, hvor produktet er blevet købt.
- Hvis dit Kenwood-produkt er defekt, eller du finder nogen fejl, skal du sende det eller bringe det til et autoriseret KENWOOD-servicecenter. For at finde opdaterede oplysninger om dit nærmeste autoriserede KENWOOD-servicecenter kan du gå til www.kenwoodworld.com eller webstedet for dit land.
- Designet og udviklet af Kenwood i Storbritannien.
- Fremstillet i Kina.



VIGTIG INFORMATION ANGÅENDE KORREKT BORTSKAFFELSE AF PRODUKTET I OVERENSSTEMMELSE MED EU-DIREKTIVET OM AFFALD AF ELEKTRISK OG ELEKTRONISK UDSTYR (WEEE)

Ved afslutningen af dets produktive liv må produktet ikke bortskaffes som almindeligt affald. Det bør afleveres på et specialiseret lokalt genbrugscenter eller til en forhandler, der yder denne service.

Fejlsøgningsguide

Problem	Årsag	Løsning
Processoren fungerer ikke.	Ingen strøm.	Kontrollér, at foodprocessorsens stik er sat i en stikkontakt.
	Skålen er ikke sat korrekt på motorenheden.	Foodprocessoren vil ikke fungere, hvis skålen eller låget ikke er sat korrekt i låsen.
	Låget til skålen er ikke låst rigtigt på.	Kontroller, at skålen og låget er rettet ind og låst korrekt.
Foodprocessor stopper, mens den er i gang.	Foodprocessoren er overbelastet/de maksimale mængder er overskredet.	Kontrollér den maksimale kapacitet i oversigten over anbefalet brug.
	Låget er låst op.	Kontrollér, at låget sidder korrekt låst fast.
Skålen kan ikke sættes på basis med påsat låg.	Tænd-/slukkontakten står i positionen "On".	Flyt kontakten til positionen "off".
Maden kommer ikke ud af Express Serve-udgangen.	Slyngepladen er ikke påsat under skiven til skiveskæring/rivning.	Påsat slyngepladen.
Skiveskåret eller revet mad beskadiges af kniven.	Betjening med kniv og plade påsat i skålen.	Fjern kniven, før skiven til skiveskæring/rivning anvendes.
Enhed ustabil/ kraftig vibration og bevægelse.	For langvarig tilberedning af dej.	Hold igen i håndtaget på låget, hvis apparatet begynder at flytte sig på køkkenbordet.
	Foodprocessoren er overbelastet/de maksimale mængder er overskredet.	Undlad at tilberede dej i mere end 30 sekunder, og overskrid ikke den maksimale mængde, der anbefales i oversigten over anbefalet brug.
	Gentagen æltning af dej.	Ælt kun igen i hånden. Det anbefales ikke at ælte igen i skålen, da det kan medføre, at foodprocessoren bliver ustabil.
	Der tilberedes klæbrig frugt/klæbrige ingredienser såsom dadler.	De bedste resultater opnås ved først at bruge "impuls" til at findele ingredienserne og derefter fortsætte uden stop.
Kraftige sprøjt, eller ingredienser kastes ud af påfyldningstragten.	Pusher not fitted.	Isæt altid nedstopperen, når du tilbereder gærdej, mørdej og kager, for at undgå sprøjt ud af påfyldningstragten.
Kniven og pladen virker ikke efter hensigten.	Se afsnittet Vink og tips, og følg anbefalingerne i oversigten over anbefalet brug.	

Fejlsøgningsguide

Problem	Årsag	Løsning
Den personlige blender/hakker kan ikke køre.	Den personlige blender/hakker ikke låst rigtigt. Bunden til den personlige blender/hakker er ikke låst rigtigt	Den personlige blender/hakker kan ikke køre, hvis den ikke er låst rigtigt.
Lækage fra den personlige blender/hakker fra knivhedsbunden.	Der mangler en tætningsring. Tætningsringen er sat forkert på. Tætningsringen er beskadiget. Knivholderen er ikke spændt helt/helt korrekt.	Kontrollér, at knivholderen er skruet helt fast. Kontroller, at forseglingen er påsat korrekt i rillen i henhold til diagram J3 og ikke beskadiget. Se "Service og kundepleje" for at få erstattet tætningsringen.
Personlig blender/hakker lækker fra drikkelåget.	Låg ikke låst.	Check, at låget er låst korrekt fast.

Svenska

- Viktig säkerhetsinformation [218-220](#)
- Innan du sätter i kontakten [220](#)
- Skötsel och rengöring [221-222](#)
- Lista över delar [223-224](#)
- Använda matberedaren – knivblad [225-227](#)
 - Användningsdiagram och bruksanvisning [225-226](#)
 - Diagram över användning [226](#)
 - Recept [227](#)
- Använda matberedaren - skivor [227-228](#)
 - Användningsdiagram och bruksanvisning [227-228](#)
 - Diagram över användning [228](#)
- Använda Express Serve [229-230](#)
 - Användningsdiagram och bruksanvisning [229](#)
 - Diagram över användning [230](#)
- Använda den personlig mixern/hackaren [231-235](#)
 - Användningsdiagram och bruksanvisning [231-233](#)
 - Diagram över användning [234](#)
 - Recept [235](#)
- Sladdjustering [235](#)
- Förvaring [236](#)
- Service och kundtjänst [237](#)
- Problemsökning [238-239](#)

Viktig säkerhetsinformation



- Läs bruksanvisningen noggrant och spara den för framtida bruk.
- Innan du använder produkten för första gången ska du ta bort allt emballage, alla marknadsföringsdokument och plastskydden på bladen. Diska delarna, se: "Skötsel och rengöring".
- Om kontakten eller sladden är skadad måste den av säkerhetsskäl bytas ut av Kenwood eller av en auktoriserad Kenwood-reparatör för att undvika fara.
- **RÖR INTE de vassa bladen.** Bladen och skivorna är mycket vassa. Hantera dem försiktigt! **Håll alltid i greppet högst upp med eggen vänd bortåt när du hanterar de vassa knivarna, tömmer skålen eller vid rengöring.**
- **Matberedarskålen och Express Serve-enheten är inte lämpliga för att krossa isbitar.**
- Innan du lyfter eller bär apparaten i handtaget på locket ska du kontrollera att skålen och locket är ordentligt fastsatta.
- Bearbeta **inte** uppvärmda ingredienser i någon av de medföljande behållarna, inklusive den personliga mixern. Varma vätskor kan spruta ut ur apparaten på grund av plötslig ångbildning.
- Lämna **aldrig** apparaten obevakad när den är igång.
- Flytta **inte** på apparaten medan den körs.
- Överskrid **inte** den maximala kapaciteten som anges i diagrammet "Rekommenderad användning".
- **Använd inte apparaten i mer än 30 sekunder när du bearbetar degen utan en viloperiod på 5 minuter. Kontinuerlig bearbetning under längre perioder kan skada apparaten.**
- Ta **alltid** bort kniven och skivorna innan du tömmer matberedarskålen.
- Stick inte ner händer eller redskap i matberedarskålen när enheten är ansluten till strömförsörjningen.
- Om du behöver trycka ned mat i matberedarskålen ska du använda ett lämpligt verktyg, t.ex. en stekspade.
- Använd **aldrig** fingrarna för att trycka ner bitar i matarröret. Använd alltid matarstaven som medföljer.
- Stäng **alltid** av apparaten och koppla bort den från eluttaget om den lämnas obevakad samt innan montering, nedmontering eller rengöring.
- VARNING! Innan du tar av locket från skålen ska du vänta tills dess att tillbehöret/knivbladen har stannat helt.
- Använd **inte** överdriven kraft för att pressa ned livsmedel i matarröret - du kan skada apparaten.
- Använd **inte** lockets låsanordning för att köra matberedaren, använd alltid hastighetsreglaget.
- Kör **inte** matberedaren med både knivbladet och en skiva monterad. Använd endast ett tillbehör åt gången.
- **Denna apparat skadas och kan orsaka skada om låsmekanismen utsätts för alltför stor kraft.**
- Använd endast tillbehör som är direkt avsedda för denna apparat.
- Använd aldrig en skadad apparat. Se till att den undersöks eller repareras: se "Service och kundtjänst".

- Låt aldrig drivenhet, sladd eller kontakt bli våta.
- Låt inte sladden hänga ner över kanten på bordet eller arbetsbänken eller komma åt en het yta.
- Barn får inte leka med apparaten. Lämna dem inte ensamma med den.
- Denna apparat ska inte användas av barn. Håll apparat och sladden utom räckhåll för barn.
- Apparaten kan användas av personer med begränsad fysisk eller mental förmåga eller begränsad känsel eller med bristande erfarenhet eller kunskap, om de övervakas eller får instruktioner om hur den ska användas på säkert sätt och förstår de medföljande riskerna.
- Använd apparaten endast för avsett ändamål i hemmet. Kenwood tar inte på sig något ansvar om apparaten används på felaktigt sätt eller om dessa instruktioner inte följs.
- Om du använder apparaten på fel sätt kan det resultera i skada.

Express Serve

- Undvik kontakt med rörliga delar. Håll fingrarna borta från utloppet för livsmedel.
- Kör inte utan att slungskivan är monterad. **Om slungskivan inte är monterad fastnar mat under skivan istället för att komma ut genom utloppet, vilket kan förstöra tillbehöret.**
- Om livsmedlen inte passerar ut genom utloppet, stäng av och kontrollera att mat inte har fastnat under skivan och att slungskivan är monterad. Avlägsna livsmedel som fastnat innan du fortsätter bearbetningen.
- **Kör inte Express Serve-tillbehöret kontinuerligt längre än 2 minuter. Låt svalna 2 minuter mellan varje 2-minuters bearbetning.**

Säkerhet för personlig mixer/hackare

-  Bearbeta **INTE** heta ingredienser
-  Mixa **INTE** kolsyrade vätskor.
- **SKÅLLNINGSRISK:** Låt heta ingredienser svalna till rumstemperatur innan du placerar dem i flaskan eller mixar dem.
- Förvara inte ingredienser i flaskan längre än 24 timmar.
- Var **alltid** försiktig när du hanterar bladensheten och undvik att röra vid bladens eggare vid rengöring
- Kör **aldrig** mixern/hackaren tom.
- Smoothierecept - blanda aldrig frysta ingredienser som har bildat en fast massa; bryt isär massan innan du lägger ingredienserna i flaskan.
- Använd endast flaskan med medföljande bladenshet.
- Drick **aldrig** varma drycker direkt från flaskan.
- Se till att drycken är ordentligt mixad och slät om du ska dricka genom locket. Du kan behöva prova dig fram innan du får önskat resultat. Det gäller framför allt om du mixar fast eller omogen frukt, då det kan hända att dessa ingredienser inte bearbetas fullt ut.
- Mixa **inte** frysta ingredienser utan vätska (med undantag för isbitar).
- Bland aldrig fryst frukt eller frysta grönsaker som är större än 3 cm x 3 cm.
- Mixa **aldrig** torra ingredienser (t.ex. kryddor, nötter) och kör aldrig mixern/hackaren när den är tom.

- Montera **aldrig** bladenheten på drivenheten utan att flaskan är monterad.
- Ta **alltid** bort kärnor från torkad frukt innan du hackar den.

Elförbrukning

- När apparaten inte är i drift
 - Automatisk växling till AV-läge: Ej tillämpligt
 - Effekt vid AV-läge: $\leq 0,3$ W.

Innan du sätter i kontakten

- Kontrollera att din eltyp är samma som anges på apparatens undersida.
- Den här apparaten uppfyller EG förordning 1935/2004 om material och produkter avsedda att komma i kontakt med livsmedel.







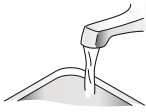

Innan du använder apparaten för första gången

- 1 Ta bort plasticskyddet från knivbladet. Var försiktig eftersom knivarna är mycket vassa. Detta skydd ska kasseras eftersom det endast är avsett för att skydda bladet i samband med tillverkning och transport.
- 2 Tvätta delarna. Se avsnittet "Skötsel och rengöring".

Skötsel och rengöring

			
	X	X	✓
	✓	✓	X
	✓	✓	X
	✓	✓	X
	✓	✓	X
	✓	✓	X
	✓	✓	X
	✓	✓	X
	✓	✓	X

Skötsel och rengöring

			
	X	X	✓
	✓	✓	X
	✓	✓	X
	✓	✓	X
	✓	✓	X
	✓	✓	X
	✓	✓	X

- Stäng av och vänta tills tillbehöret/knivarna har stannat och dra ur kontakten innan du rengör apparaten och dess delar.
- Torka av drivenheten med en fuktig trasa, torka sedan. Se till att livsmedelsrester rensas bort från låsanordningen.
- Sänk inte ned drivenheten i vatten.
- Hantera knivbladen och skärskivorna med försiktighet - de är mycket vassa.
- Om du tvättar bladen till den personliga mixern/hackaren för hand ska du borsta rent och skölja av dem med rinnande vatten.

Lista över delar

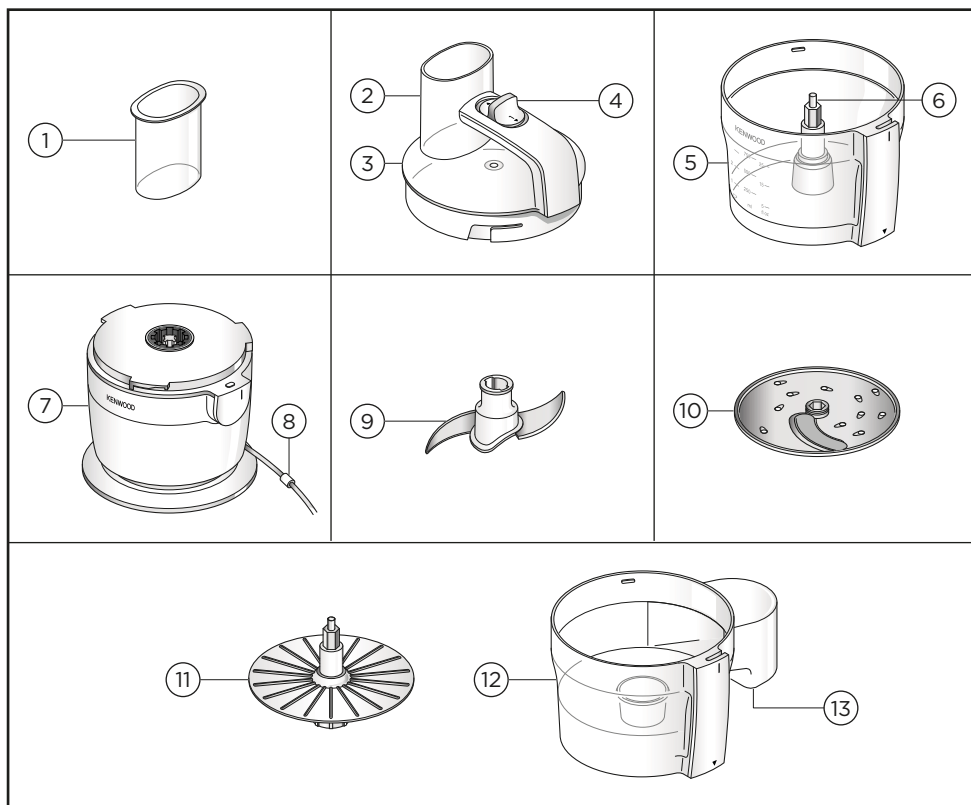

* Om sådan medföljer

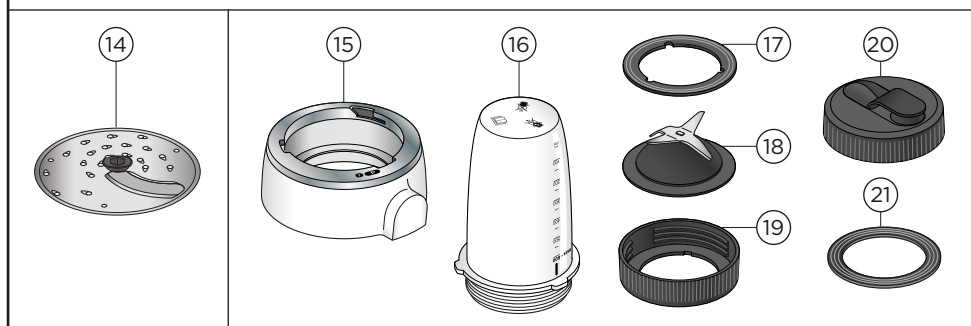

Förklaring till bilder

Matberedare

- ① Matarstav
- ② Matarrör
- ③ Lock
- ④ På/av-knapp + pulsknapp
- ⑤ Skål
- ⑥ Drivenhet i skålen
- ⑦ Drivenhet
- ⑧ Sladdklämma
- ⑨ Knivblad
- ⑩ 4 mm skivnings/rivningsskiva

Express Serve

- ⑪ Slungskiva
- ⑫ Express Serve-skål
- ⑬ Utlopp för livsmedel

Skivor

- ⑭ 2 mm skivnings/rivningsskiva (om sådan medföljer)

Personlig mixer/hackare

- ⑮ Bas för personlig mixer/hackare
- ⑯ Flaska
- ⑰ Tätningsring
- ⑱ Bladenhet
- ⑲ Bladhållare
- ⑳ Flasklock
- ㉑ Tätningsring till flasklock

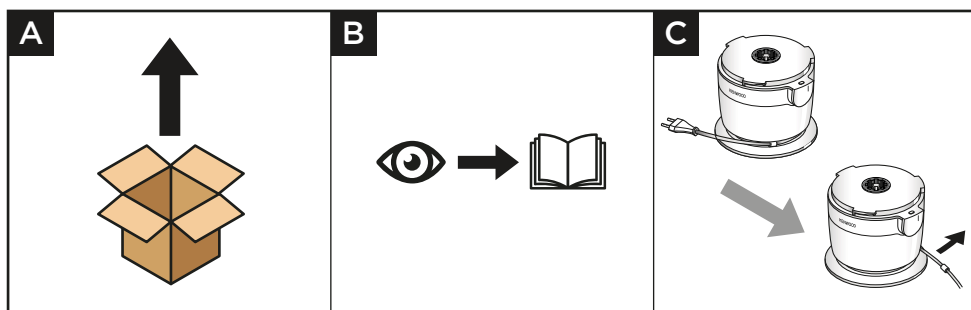

Använda matberedaren – knivblad

Användningsdiagram och bruksanvisning

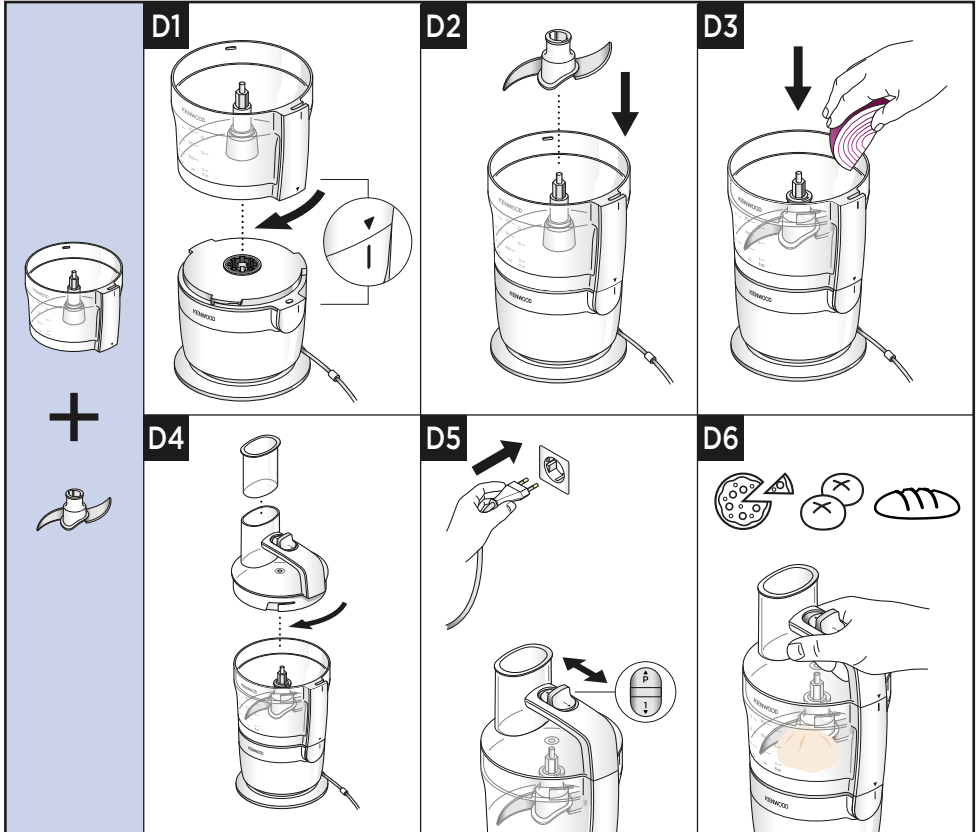

Viktigt

- Matberedaren lämpar sig inte för att mala kaffeböner och kryddor eller göra florsocker av strösocker eller krossa isbitar.
- När du tillsätter bittermandelessens eller andra smaktillsatser måste du undvika att dessa kommer i direktkontakt med plasten, eftersom det kan orsaka bestående missfärgningar.
- Sätt alltid skålen och tillbehöret på matberedaren innan du tillsätter ingredienserna.
- Använd inte locket för att köra matberedaren.
- Matberedaren fungerar inte om skålen eller locket inte är ordentligt fastlåsta. Kontrollera att matarröret och skålets handtag sitter i det högra hörnet på framsidan.
- Stäng alltid av och koppla ur innan du tar bort locket.
- Bröddegar ska inte bearbetas längre än 30 sekunder.
- Fortsatt knådning av bröddegen ska enbart ske för hand. Att knåda degen i skålen rekommenderas inte eftersom matberedaren kan bli instabil.
- Håll alltid enheten i handtaget när du bearbetar deg.

- 1 Placera skålen på drivenheten och vrid medurs tills den är fastlåst.
- 2 Montera knivbladet ovanför drivaxeln.
- 3 Tillsätt ingredienserna i matberedarskålen.
- 4 Sätt på locket.
- 5 Anslut enheten till elnätet.
- 6 Slå på enheten eller använd pulsfunktionen.

Tips och idéer

- Använd pulsknappen (P) för korta stötar. Pulskörningen pågår så länge reglaget är aktiverat.
- Vissa livsmedel kan missfärga plasten. Detta är helt normalt och skadar inte plasten eller påverkar smaken på dina livsmedel. Gnugga med en trasa doppad i vegetabilisk olja för att ta bort missfärgning.
- **Bröddeg** - Placera först de torra ingredienserna i skålen och tillsätt sedan vätska. Bearbeta tills dess att en jämn, elastisk boll av deg bildas.
- Använd handtaget på locket för att hålla fast apparaten om den börjar förflytta sig på arbetsbänken.
- Använd pulsfunktionen för grövre konsistens.
- Var noga med att inte arbeta degen för mycket.
- Använd kylskåpskallt matfett skuret i 2 cm kuber till pajdeg.

Diagram över användning

E		MAX (g)	(S)
		20-30	10-20
		200	30
		150	20-30
	2 cm	300	10/P
	1/4	200	P
	2-3 cm	250	15-20
	2 cm	100-200	20
		400	60
		x3 + 300 ml	45-60
		250 g + 150 g	30
		250 g	10-30
		x3 + 150 g + 150 g + 18-22° C + 150 g	20

Recept

Katrinplommonmarinad

400 g honung

40 g katrinplommon

50 ml vatten

- 1 Förvara i kylen under natten.
- 2 Bearbeta i 4 sekunder med hjälp av pulsfunktionen.

Använda matberedaren - skivor

Användningsdiagram och bruksanvisning

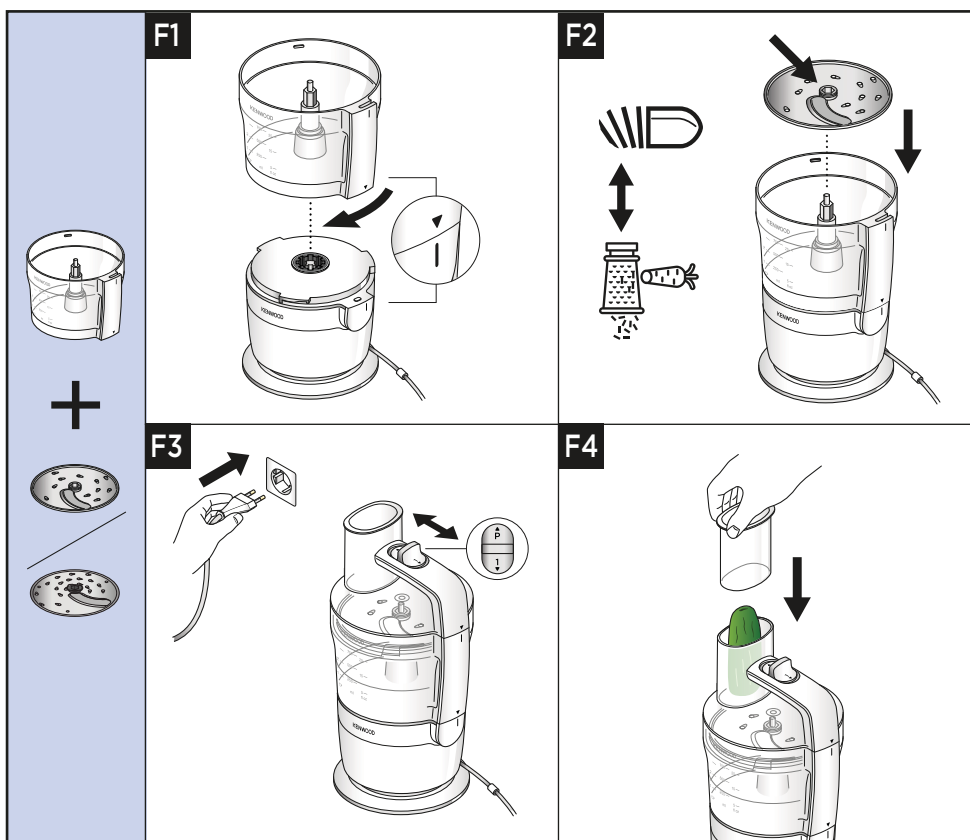

Viktigt













- Stoppa aldrig ner fingrarna i matarröret.

- 1 Placera skålen på drivenheten och vrid medurs tills den är fastlåst.
- 2 Håll i handtaget i mitten och lägg skivan på drivaxeln med önskad sida uppåt.
- 3 Sätt på locket.
- 4 Placera livsmedlen i matarröret.
- 5 Anslut apparaten till eluttaget, välj hastighet 1 och pressa matarstaven nedåt med jämn kraft.

Tips och idéer

- Använd färska ingredienser.
- Skär inte livsmedlen i alltför små bitar. Fyll matarröret till bredden med ingredienserna (undvik att packa dem alltför kompakt). Detta förhindrar att livsmedel glider i sidled under bearbetningen.
- Om bitarna läggs i upprätt blir de kortare än om de läggs i liggande.
- Det blir alltid lite rester av livsmedel kvar på skivan eller i skålen efter bearbetning.

Diagram över användning

G		 MAX (g)	 (secs)
		750 ml 	10-20
		750 ml 	10-20
		 MAX (g)	 (secs)
		750 ml 	10-20

Använda Express Serve

Användningsdiagram och bruksanvisning

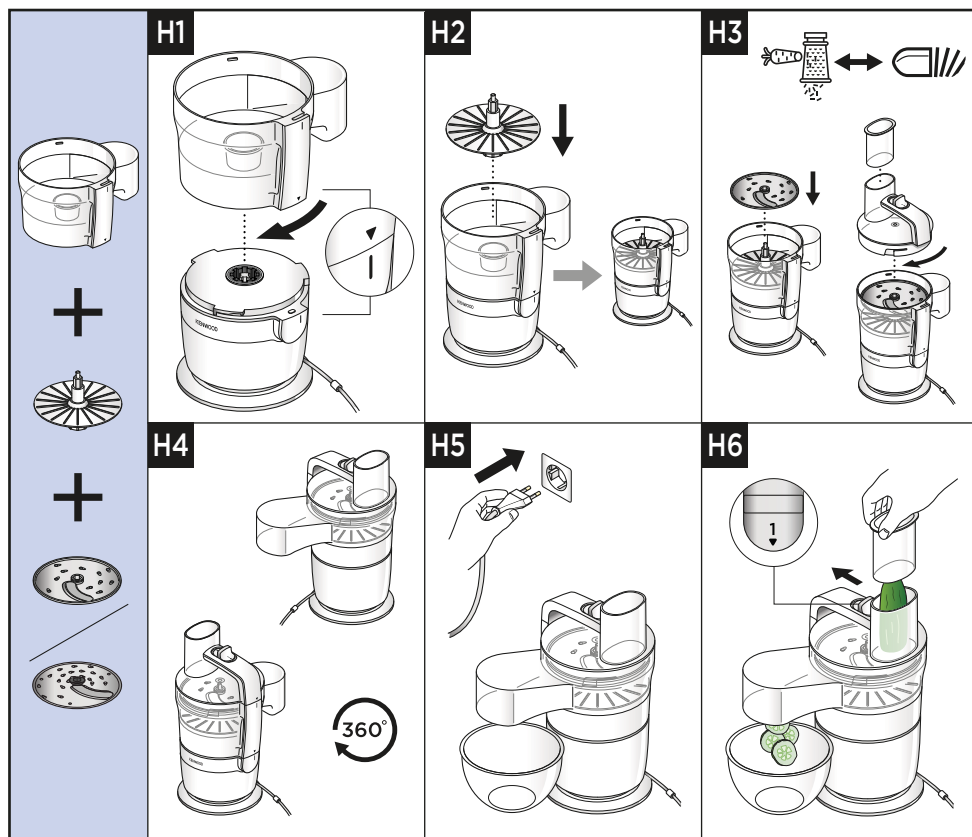











Viktigt

- Använd inte för mycket kraft då du använder tillbehöret.
- Om livsmedlen inte passerar ut genom utloppet, stäng av apparaten och kontrollera att inget har fastnat under skivan och att slungskivan är monterad. Avlägsna livsmedel som fastnat innan du fortsätter bearbetningen.

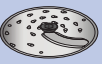
- 1 Placera skålen på drivenheten och vrid medurs tills den är fastlåst.
- 2 Montera slungskivan och önskad skärskiva.
- 3 Sätt på locket.
- 4 Placera livsmedlen i matarröret.
- 5 Anslut apparaten till eluttaget, välj hastighet 1 och pressa matarstaven nedåt med jämn kraft.

Diagram över användning

I 	 MAX (g)	 (S)
		120
		120
	 MAX (g)	 (S)
		120

Använda den personlig mixern/hackaren

Användningsdiagram och bruksanvisning

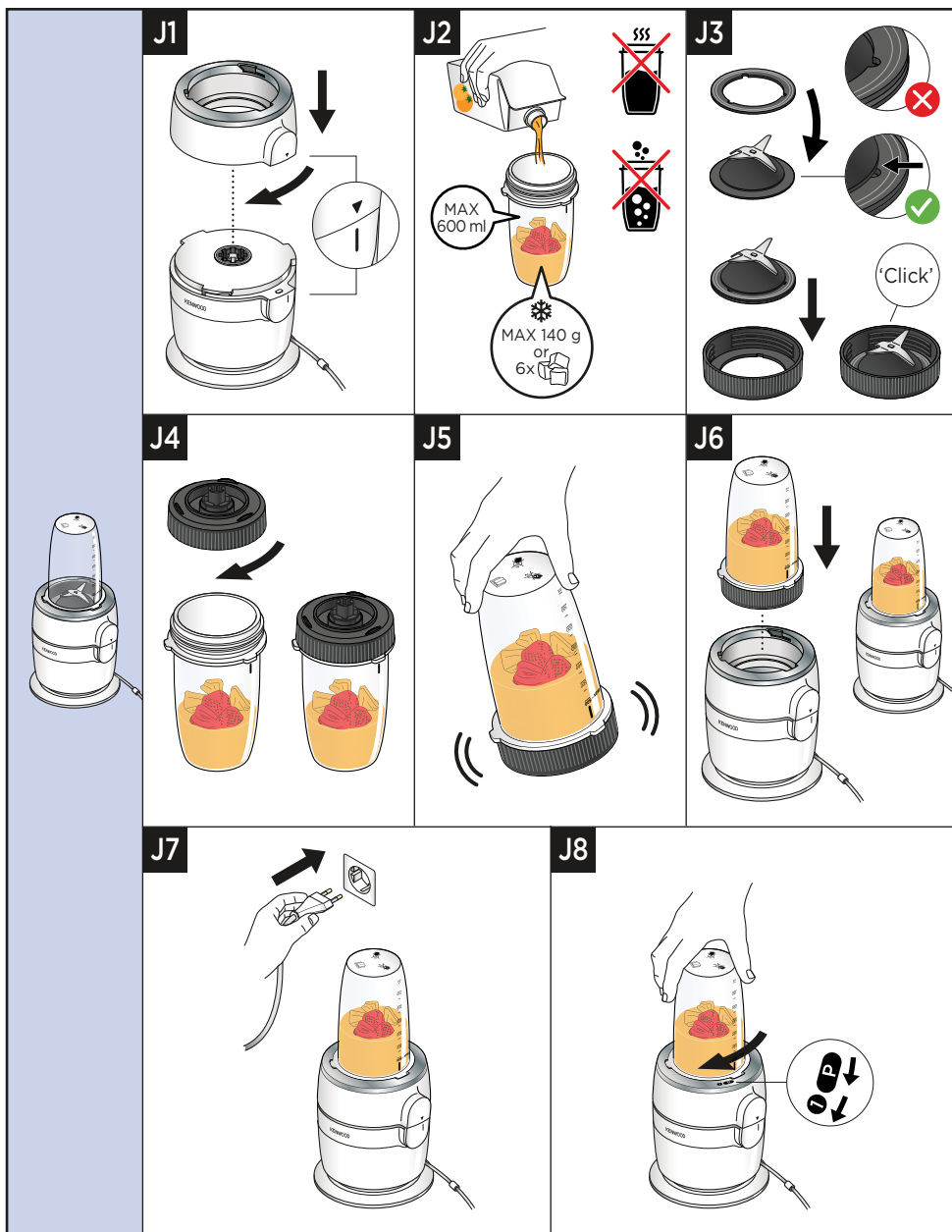

Använda den personlig mixern/hackaren

Användningsdiagram och bruksanvisning

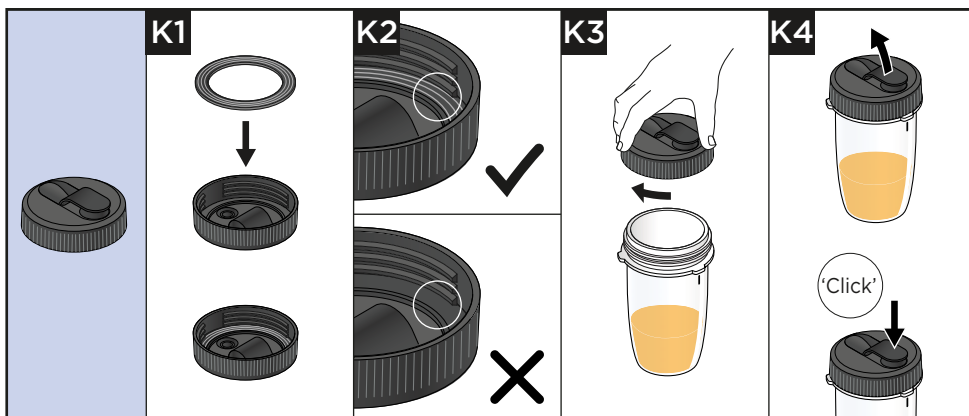

Viktigt

- Basen till den personliga mixern/hackaren bas måste monteras på drivenheten innan den personliga mixern/hackaren monteras.
- Mixa inte frysta ingredienser utan vätska (med undantag för isbitar).
- Läckage förekommer om tätningen är skadad eller felaktigt monterad.
- Blanda aldrig frysta ingredienser som har bildat en fast massa.
- Bland aldrig fryst frukt eller frysta grönsaker som är större än 3 cm x 3 cm.
- För bästa mixresultat ska du alltid tillsätta is/frysta ingredienser i flaskan först.
- Ta **alltid** bort kärnor från torkad frukt innan du hackar den.

- 1 Placera basen till den personliga mixern/hackaren på drivenheten och vrid medurs tills basen är fastlåst.
- 2 Tillsätt ingredienser i flaskan, upp till 600 ml-markeringen.
- 3 Se till att tätningens ring är placerad på rätt sätt i spåret när du monterar den på bladenheten.
- 4 Sänk försiktigt ned knivenheten på knivhållaren tills den klickar på plats.
- 5 Håll i undersidan av den monterade knivenheten och sänk ner den i flaskan med bladen nedåt.
- 6 Skruva fast den monterade knivhållaren i flaskan – vrid medurs för att låsa.
- 7 Skaka för att blanda ingredienserna.
- 8 Sänk ned tillbehöret på drivenheten.
- 9 Sätt i kontakten. Om du vill välja pulshastighet vrider du medurs (mot P) och släpper tillbehöret. Om du vill välja kontinuerlig hastighet vrider du tillbehöret medurs (mot 1) tills det låses på plats.











Flasklock

- 10 Sätt tätningsringen på flasklocket och se till att tätningen är placerad på rätt sätt i spåret.
- 11 För att använda flasklocket ska du skruva loss den monterade knivenheten från flaskan. Sätt på flasklocket och lås fast det genom att vrida det medurs.
- 12 När du vill dricka behöver du bara lyfta upp fliken på locket. Drycken kan drickas direkt från flaskan.
- 13 När du har druckit färdig stänger du fliken igen. Tryck ordentligt för att se till att fliken är stängd.

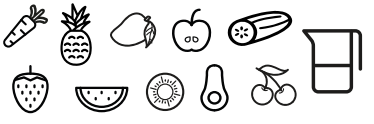
Tips och idéer

- Observera att när flaskan är fylld till maximum (600 ml) motsvarar det ungefär två portioner.
- Om du inte har för avsikt att konsumera din dryck omedelbart ska du förvara den i kylskåp och konsumera den inom 24 timmar.
- Kontrollera att drycken är tillräckligt lättflytande för att du ska kunna dricka den genom dricklocket. Tillsätt mer vätska om du vill ha en tunnare dryck.
- Vissa drycker är inte helt släta efter att de mixats på grund av att de innehåller frön eller fiberhaltiga ingredienser.
- Vissa drycker kan separera om de står en lång stund. Därför är det bäst att dricka dem direkt. Om ingredienserna har separerats rör om drycken innan du dricker den.
- Håll alltid flaskan upprätt när flasklocket är monterat.

Diagram över användning

L		 MAX (g)		 (S)
	 3 cm	600 ml	1	30-60
		100 g	10-20	P
		X 6 120-140 g	P	10-20
		50 g	P	10-20
		100 g	1	30-60
		50 g	P	10

Recipe

Pesto

60 g färsk basilika

1 vitlöksklyfta

25 g pinjenötter

25 g riven parmesan

110 g olivolja

Salt – efter tycke och smak

Peppar – efter tycke och smak

- 1 Lägg alla ingredienser i mixerns/hackarens skål. Kör med pulsfunktionen 5 gånger, följt av kontinuerlig bearbetning tills önskad konsistens uppnås (cirka 25 sekunder).

Katrinplommonmarinad

300 g honung

40 g katrinplommon

70 ml vatten

- 1 Lägg alla ingredienser i mixerns/hackarens skål. Förvara i kylan över natten. (Förvara inte ingredienser i flaskan längre än 24 timmar).
- 2 Bearbeta i 4 sekunder med pulshastighet. Använd omedelbart.

Sladdjustering

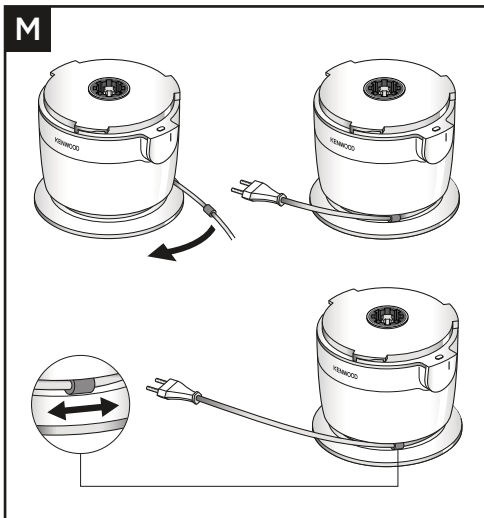

- Linda sladden runt matberedarens bas till önskad längd och kläm fast den med hjälp av sladdklämman.

Förvaring

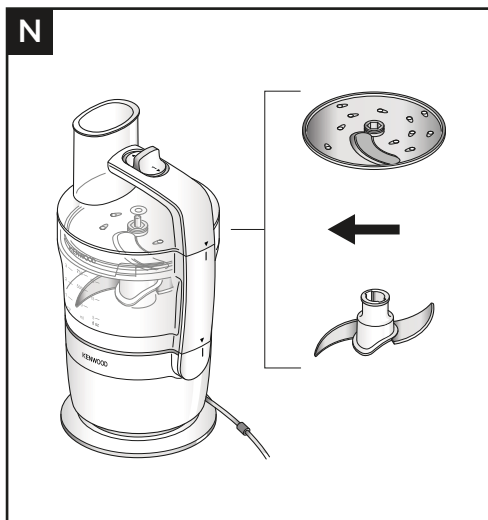

- Efter användning kan knivbladet och en skiva förvaras tillsammans i skålen.
- Den andra skivan (om den ingår i leveransen) kan förvaras i Express Serve-skålen.
- Kör inte matberedaren med både knivbladet och en skiva monterad. Använd endast ett tillbehör åt gången.

Service och kundtjänst

- Om du får problem med att använda apparaten ber vi dig att läsa avsnittet om "Problemsökning" i bruksanvisningen eller på www.kenwoodworld.com innan du ringer kundtjänst.
- Produkten omfattas av en garanti som efterföljer alla lagstadgade bestämmelser vad gäller garanti och konsumenträttigheter i inköpslandet.
- Om din Kenwood-produkt inte fungerar som den ska eller om du upptäcker fel ber vi dig att lämna eller skicka in den till ett godkänt KENWOOD-servicecenter. För aktuell information om närmaste godkända KENWOOD-servicecenter besök www.kenwoodworld.com eller Kenwoods webbplats för ditt land.
- Konstruerad och utvecklad av Kenwood i Storbritannien.
- Tillverkad i Kina.



VIKTIG INFORMATION OM HUR PRODUKTEN SKALL KASSERAS I ENLIGHET MED EUROPEISKA DIREKTIV OM AVFALL SOM UTGÖRS AV ELLER INNEHÅLLER ELEKTRISK OCH ELEKTRONISK UTRUSTNING (WEEE)

När produktens livslängd är över får den inte slängas i hushållssoporna. Den kan överlämnas till lokala myndigheters avfallssorteringscentraler eller till en återförsäljare som tillhandahåller denna service.

Problemsökning

Problem	Orsak	Lösning
Matberedaren fungerar inte	Ingen ström	Kontrollera att matberedaren är ansluten till eluttaget.
	Skålen har inte satts fast på drivenheten på rätt sätt.	Matberedaren fungerar inte om skålen eller locket inte är fastsatta på rätt sätt.
	Skålens lock är inte låst på rätt sätt.	Kontrollera att skålen och locket är inpassade på rätt sätt och ihoplåsta.
Matberedaren stannar under beredningen	Matberedaren är överbelastad/maximal kapacitet har överskridits.	Kontrollera maxkapaciteterna som anges i tabellen Rekommenderad användning.
	Locket är inte låst.	Kontrollera att locket är ordentligt fastsatt.
Kan inte montera skålen på basen med locket monterat.	På/av-reglaget är i läge "På".	Vrid reglaget till läge "Av".
Livsmedel passerar inte ut genom utloppet på express serve.	Slungskivan är inte monterad under skivnings-/rivningsskivan.	Montera slungskivan.
Skivade eller rivna livsmedel skadade av knivbladet.	Apparaten används med både kniv och skiva monterade i skålen.	Ta bort knivbladet innan du använder skivnings-/rivningsskivan.
Enheten instabil/ stora vibrationer och rörelser.	Degen bearbetas för länge.	Använd handtaget på locket för att hålla fast apparaten om den börjar förflytta sig på arbetsbänken. Bearbeta inte degar längre än 30 sekunder och överskrid inte maximal rekommenderad mängd som anges i tabellen över Rekommenderad användning.
	Matberedaren är överbelastad/maximal kapacitet har överskridits.	
	Upprepar knådning av deg.	Utför bara upprepad knådning för hand. Att utföra upprepad knådning i skålen rekommenderas inte då det kan göra matberedaren instabil.
	Kladdiga frukter/ ingredienser, t.ex. dadlar, bearbetas.	För att nå bästa resultat kan du först använda "pulsknappen" för att bryta ner ingredienserna och därefter använda kontinuerlig drift.
Det stänker mycket eller ingredienserna sprutar ut från matarröret.	Matarstaven inte monterad.	Montera alltid matarstaven när du bearbetar deg, smördeg och kaksmet för att förhindra att det stänker från matarröret.
Knivbladet och skivan fungerar dåligt.	Se avsnittet Tips och idéer och följ rekommendationerna i tabellen Rekommenderad användning.	

Problemsökning

Problem	Orsak	Lösning
Den personliga mixern/hackaren fungerar inte.	Den personliga mixern/hackaren är inte låst på rätt sätt. Basen till den personliga mixerbasen är inte låst på rätt sätt.	Den personliga mixern/hackaren kommer inte att fungera om den är låst på fel sätt.
Den personliga mixern/hackaren läcker vid bladenhetens bas.	Tätningringen saknas. Tätningringen sitter inte rätt. Tätningringen skadad. Knivhållaren är inte helt/ordentligt åtdragen.	Kontrollera att knivhållaren är ordentligt fastskruvad. Kontrollera att tätningen sitter korrekt i spåret enligt diagram J3 och inte är skadad. Se "Service och kundtjänst" om du behöver en ny tätningring.
Den personliga mixern/hackaren läcker vid drickslocket.	Locket är inte låst.	Kontrollera att locket låsts ordentligt.

Norsk

- Viktig sikkerhetsinformasjon [241-243](#)
- Før du setter i støpselet [243](#)
- Rengjøring og vedlikehold [244-245](#)
- Deleliste [246-247](#)
- For å bruke Kjøkkenmaskinen din - Knivblad [248-250](#)
 - Bruksdiagram og brukerinstruksjoner [248-249](#)
 - Brukstabell [250](#)
 - Oppskrift [250](#)
- For å bruke Kjøkkenmaskinen din - Skiver [251-252](#)
 - Bruksdiagram og brukerinstruksjoner [251-252](#)
 - Brukstabell [252](#)
- For å bruke din Express Serve [253-254](#)
 - Bruksdiagram og brukerinstruksjoner [253](#)
 - Brukstabell [254](#)
- For å bruke din Personal Blender/Hakker [255-259](#)
 - Bruksdiagram og brukerinstruksjoner [255-257](#)
 - Brukstabell [258](#)
 - Oppskrift [259](#)
- Justering av ledning [259](#)
- Oppbevaring [260](#)
- Service og kundetjeneste [261](#)
- Feilsøkningsveiledning [262-263](#)

Viktig sikkerhetsinformasjon



- Read these instructions carefully and retain for future reference.
- Fjern all emballasje og markedsføringsmaterieell før første gangs bruk og plastdekselblader. Vask delene; se Rengjøring og vedlikehold.
- Hvis støpselet eller ledningen er skadet, må de av sikkerhetshensyn skiftes ut av Kenwood eller et godkjent Kenwood-verksted for å unngå ulykker.
- **Du må IKKE ta på de skarpe bladene.** Knivene og skivene er veldig skarpe, må håndteres med forsiktighet. **Hold alltid i fingergrepet øverst, unna skjærekanten, ved håndtering av de skarpe knivene, tømning av bollen og under rengjøring.**
- **Kjøkkenmaskinens bolle og ekspressserveringsmaskinen er ikke egnet for bearbeiding av isbiter.**
- Før du løfter eller bærer apparatet i håndtaket på lokket, må du alltid kontrollere at bollen og lokket er sikkert låst på plass.
- **Ikke** behandle varme ingredienser i en av de medfølgende beholderne, inkludert den personlige blenderen. Varme væsker kan slynges ut av apparatet på grunn av plutselig dannelse av damp.
- **Ikke** gå fra apparatet mens det er i bruk.
- **Ikke** flytt apparatet mens det er i drift.
- **Ikke** overskrid maksimal kapasitet som beskrevet i tabell over anbefalt bruk.
- **Ikke bruk apparatet ditt lengre enn i 30 sekunder når du bearbeider deig uten en 5 minutters hvilepause. Kontinuerlig bearbeidelse i lengre perioder kan ødelegge apparatet ditt.**
- Fjern **alltid** knivbladet og skivene før du heller innholdet fra kjøkkenmaskinens bolle.
- Hold hender og redskaper unna kjøkkenmaskinens bolle mens den er koblet til strømforsyningen.
- Hvis maten må dyttes ned i kjøkkenmaskinens bolle, bruk et egnet redskap, for eksempel en slikkepott.
- Bruk **aldri** fingrene til å skyve ingrediensene ned i matetrakten. Du må alltid bruke stapperen som følger med.
- Slå **alltid** av apparatet og trekk ut stikkkontakten når den står uten oppsyn og før montering, demontering eller rengjøring.
- FORSIKTIG: Før du tar lokket av bollen, vent til redskapet/bladene har stoppet helt.
- **Ikke** bruk overdreven kraft for å presse maten ned i materøret – du kan skade apparatet.
- **Ikke** bruk lokklåsen til å betjene processoren, bruk alltid på/av hastighetskontrollen.
- **Ikke** bruk kjøkkenmaskinen med både knivbladet og en skive montert. Bruk kun et redskap om gangen.
- **Dette apparatet blir ødelagt og kan føre til skader hvis låsemekanismen blir utsatt for stort press.**
- **Aldri** bruk uoriginalt tilbehør.
- **Aldri** bruk et skadet apparat. Få det kontrollert eller reparert: se Service og kundetjeneste.

- La aldri strømenheten, ledningen eller støpselet bli vått.
- La ikke ledningen henge over kanten på bordet eller arbeidsbenken, eller ligge inntil varme overflater.
- Barn må ha tilsyn for å sikre at de ikke leker med apparatet.
- Dette apparatet må ikke brukes av barn. Hold apparatet og den tilhørende ledningen utenfor barns rekkevidde.
- Apparater kan brukes av personer med reduserte fysiske, sensoriske eller mentale evner, eller som mangler erfaring eller kunnskap, hvis de har fått tilsyn eller veiledning om trygg bruk av apparatet og de forstår farene det innebærer.
- Bruk bare apparatet til dets tiltenkte hjemlige bruk. Kenwood frasier seg ethvert ansvar ved feilaktig bruk eller dersom apparatet ikke er brukt i henhold til denne bruksanvisningen.
- Feil bruk av apparatet ditt kan føre til skader.

Express Serve

- Unngå kontakt med bevegelige deler. Hold fingrene unna matuttaket.
- Ikke bruk uten at slingerplaten er montert. **Hvis slingerplaten ikke er satt på, vil maten pakkes sammen under platen og ikke komme ut av matuttaket, noe som kan skade tilbehøret.**
- Hvis maten ikke kommer ut av matuttaket, slå av og kontroller at maten ikke tetter seg under skiven og at slingerplaten er montert. Fjern eventuell fastklemt mat før du fortsetter bearbeidelsen.
- **Ikke kjør Express Serve kontinuerlig i mer enn 2 minutter. La kjøle i 2 minutter mellom hver 2-minutters bruk.**

Sikkerhet ved personlig Blender / Hakker

-  **IKKE** bearbeide varme ingredienser.
-  **IKKE** blande kullsyreholdige væsker.
- **FARE FOR SKOLDING:** Varme ingredienser må avkjøles til romtemperatur før du heller dem i koppen eller før bruk av blenderen.
- Ikke oppbevar ingredienser i koppen lengre enn 24 timer.
- Vær **alltid** forsiktig når du håndterer knivenheten, og unngå å berøre skjærekanten på kniven når du rengjør.
- **Kjør aldri** blenderen/hakkeren når den er tom.
- Smoothie-oppskrifter – bland aldri frosne ingredienser som har dannet en fast masse under frysing, del den opp før du har den i koppen.
- Bruk kun koppen med det leverte monterte bladet.
- **Aldri** drikk varme væsker fra koppen.
- Når du drikker gjennom lokket, må du passe på at drikken er jevn. Det kan hende at du må eksperimentere litt for å oppnå ønsket resultat, spesielt når du behandler fast eller umoden mat siden noen ingredienser ikke blir behandlet.
- **Ikke** blande frosne ingredienser uten væske (bortsett fra isbiter).
- **Aldri** blande frosne frukt eller grønnsaker som er større enn 3 cm X 3 cm biter.
- **Aldri** bland tørre ingredienser (f.eks. krydder, nøtter) eller kjør med tom blender/hakker.
- Monter **aldri** bladet på strømenheten uten at koppen er satt på.
- **Alltid** fjern steiner i tørket frukt før du hakker den.

Strømforbruk

- Når apparatet ikke er i bruk
 - Automatisk avskruing til OFF-modus: Ikke relevant
 - Off-modus strøm: $\leq 0.3W$.

Før du setter i støpselet

- Forsikre deg om at nettspenningen stemmer overens med det som står på undersiden av apparatet.
- Dette apparatet overholder EC-forordning 1935/2004 om materialer og gjenstander som er bestemt å komme i kontakt med næringsmidler.









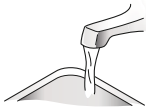

Før første gangs bruk

- 1 Fjern plastdekselet fra knivbladet. Pass på, bladene er veldig skarpe. Dette dekselet bør kastes, da det kun er for å beskytte bladet under produksjon og transport.
- 2 Vask delene, se «stell og rengjøring».

Rengjøring og vedlikehold

			
	X	X	✓
	✓	✓	X
	✓	✓	X
	✓	✓	X
	✓	✓	X
	✓	✓	X
	✓	✓	X
	✓	✓	X
	✓	✓	X

Rengjøring og vedlikehold

			
	X	X	✓
	✓	✓	X
	✓	✓	X
	✓	✓	X
	✓	✓	X
	✓	✓	X
	✓	✓	X

- Slå av og vent til tilbehøret/bladene stopper og trekk ut støpset før rengjøring.
- Tørk av strømenheten med en fuktig klut, og deretter tørk den. Sørg for at låseområdet er fritt for matrester.
- Ikke legg motordelen i vann.
- Håndter knivene og kutteskivene forsiktig – de er ekstremt skarpe.
- Hvis du vasker knivene på den personlige blenderen/hakkeren for hånd, bør de børstes rene og skylles under rennende vann.

Deleliste

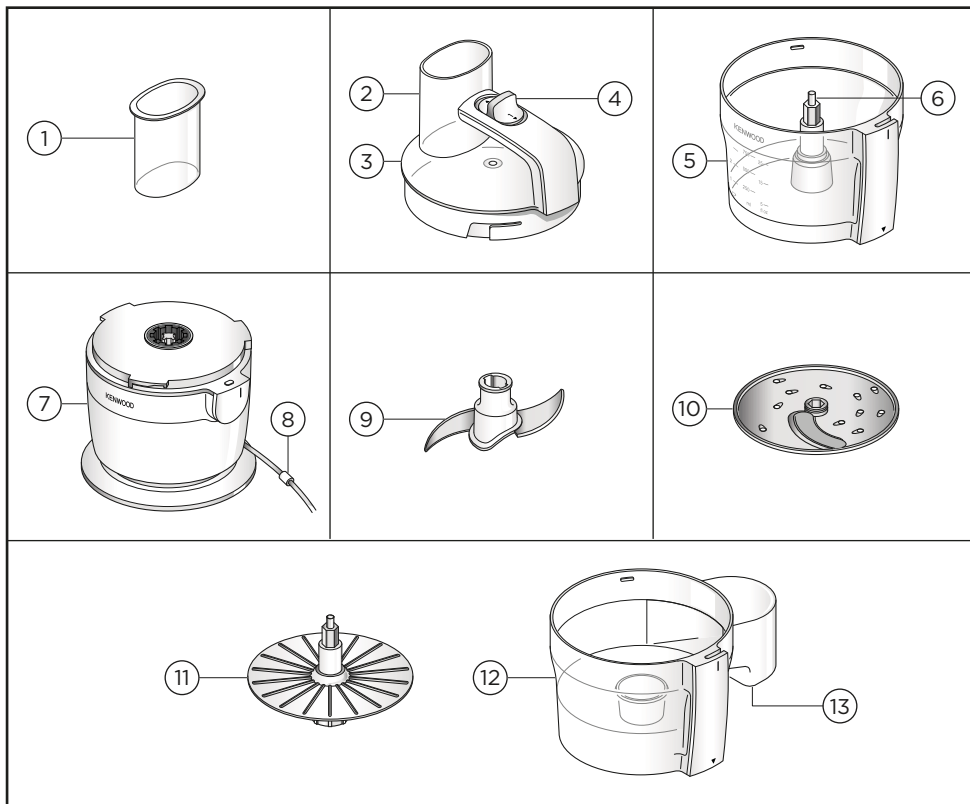

* Hvis levert

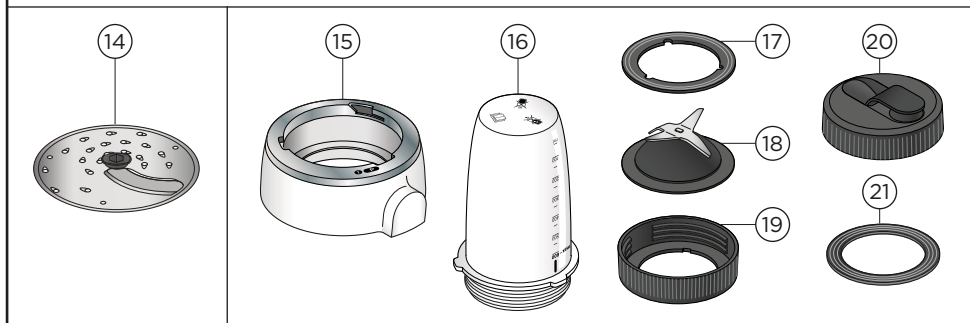

Deler

Foodprocessor

- ① Stappere
- ② Matetrakt
- ③ Lokk
- ④ På/Av bryter + Pulsering
- ⑤ Bolle
- ⑥ I Bolle-modus
- ⑦ Strømenhet
- ⑧ Ledningsklemme
- ⑨ Knivblad
- ⑩ 4 mm Skjære-/riveplate

Express Serve

- ⑪ Slingerplate
- ⑫ Express Serve Bolle
- ⑬ Matuttak

Skiver

- ⑭ 2 mm Skjære-/riveplate (hvis den medfølger)

Personlig Blender/Hakker

- ⑮ Personlig blender/hakkerbase
- ⑯ Kopp
- ⑰ Tetningsring
- ⑱ Bladenhet
- ⑲ Bladholder
- ⑳ Drikkelokk
- ㉑ Tetningsring for drikkelokk

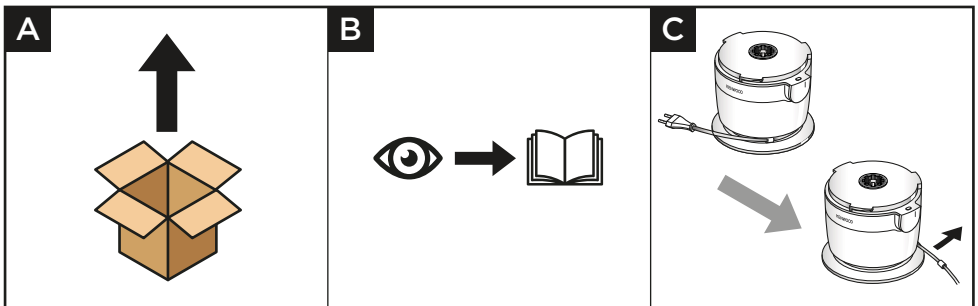

For å bruke Kjøkkenmaskinen din - Knivblad

Bruksdiagram og brukerinstruksjoner

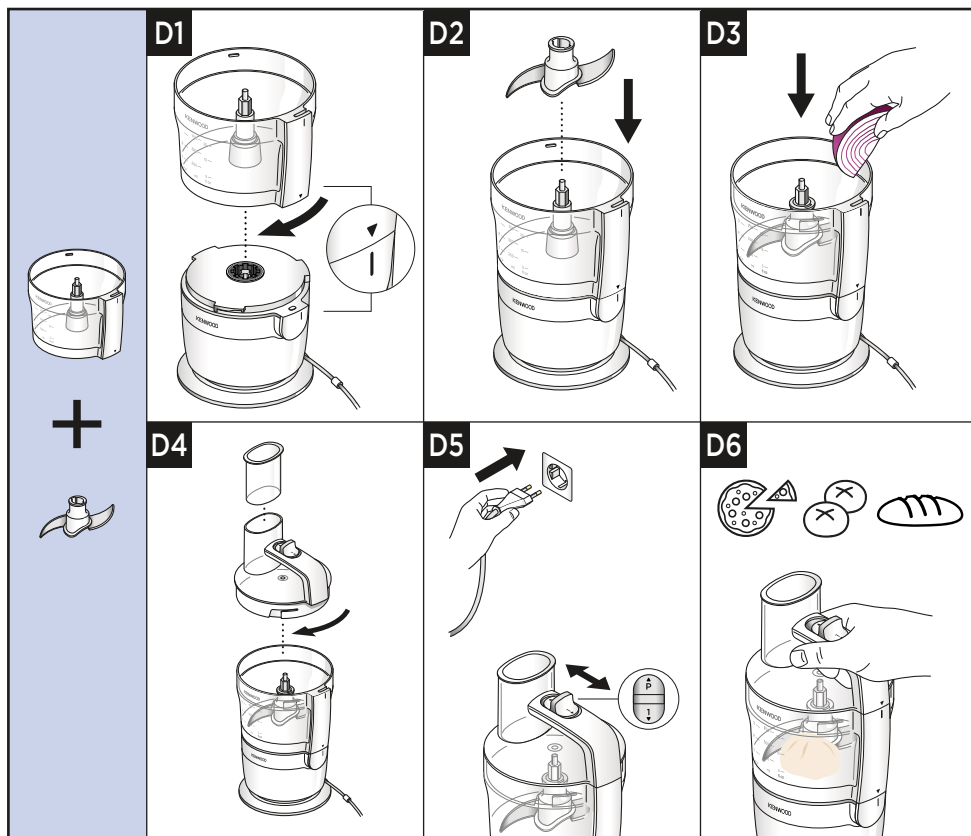

Viktig



































- Kjøkkenmaskinen din egner seg ikke til å knuse eller male kaffebønner og krydder, eller gjøre om granulert sukker til strøsuksker eller bearbeide isbiter.
- Når du tilsetter mandelessens eller andre smakstilsetninger, må ikke disse komme i kontakt med plastmaterialet da de kan lage merker.
- Sett alltid bollen og tilbehøret på plass på processoren før du legger til ingredienser.
- Ikke bruk lokket for å bruke processoren.
- Processoren fungerer ikke hvis bollen eller lokket ikke er låst korrekt på plass i sikkerhetslåsen. Sjekk at matetrakten og bollehåndtaket sitter foran til høyre.
- Slå alltid av apparatet og trekk ut støpselet før du fjerner lokket.
- Brøddeig, ikke bearbeid i mer enn 30 sekunder
- Elt deigen på nytt kun for hånd. Det anbefales ikke å elte på nytt i bollen, da det kan føre til at processoren blir det ustabil.
- Hold alltid enheten i håndtaket når du elter deig.

- 1 Monter bollen på strømenheten, vri i retning med klokken for å låse.
- 2 Monter knivbladet på drivskaftet.
- 3 Legg ingrediensene i kjøkkenmaskinbollen.
- 4 Sett på lokket.
- 5 Slå på enheten ved å koble til strømnettet.
- 6 Skru på enheten eller bruk pulseringsfunksjonen.

Råd og tips

- Bruk pulsfunksjonen (P) til korte støt. Pulsfunksjonen fungerer så lenge kontrollen holdes på plass.
- Noen matvarer kan misfarge platen. Dette er helt normalt og vil ikke skade platen eller påvirke smaken av maten. Gni med en klut dyppet i vegetabilsk olje for å fjerne misfargingen.
- **Brøddeig** - Ha først de tørre ingrediensene i bollen og tilsett deretter væsken. Elt til en jevn, elastisk deigkule dannes.
- Bruk håndtaket på lokket for å støtte hvis apparatet begynner å bevege seg på benkeplaten.
- Bruk pulskontrollen for en grovere konsistens.
- Pass på å ikke overbehandle dem.
- Når du lager bakverk bruker du fett rett fra kjøleskapet som er skåret i terninger på 2 cm.

Brukstabell

E	 MAKS (g)	 (Sek)
	20-30	10-20
	200	30
	150	20-30
 	300	10/P
 	200	P
 	250	15-20
 	100-200	20
  	400	60
	x3  + 300 ml 	45-60
  	250 g  + 150 g 	30
  	250 g 	10-30
	 x3 +  150 g +  150 g  18-22°C +  150 g	20

Oppskrift

Sviskemarinade

400 g honning

40 g svsker

50 ml vann

- 1 Oppbevares i kjøleskap over natten.
- 2 Bearbeid i 4 sekunder ved bruk av Pulsering

For å bruke Kjøkkenmaskinen din - Skiver

Bruksdiagram og brukerinstruksjoner

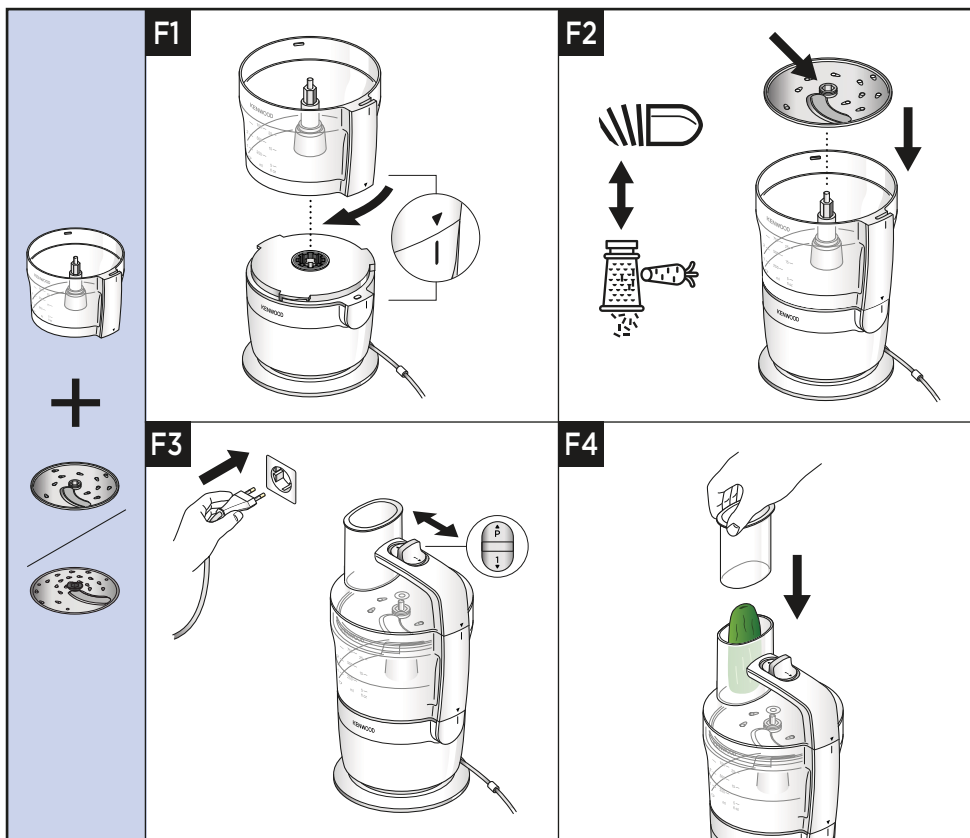

Viktig











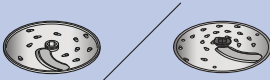

- Aldri plasser fingrene i matetrakten.

- 1 Monter bollen på strømenheten, vri i retning med klokken for å låse.
- 2 Hold i midtgrepet og plasser platen på drivakselen med passende side øverst.
- 3 Sett på lokket.
- 4 Ha maten i materøret.
- 5 Sett i kontakten, velg hastighet 1 og trykk jevnt ned med skyveren.

Råd og tips

- Bruk ferske ingredienser.
- Ikke hakk maten for fint opp. Fyll materøret med ingrediensene i hele bredden (unngå at det sitter tett). Dette forhindrer at maten glir sidelengs under bearbeiding.
- Mat som er plassert stående kommer ut kortere enn mat som er plassert liggende.
- Det kommer alltid til å ligge igjen litt rester på skiven eller i bollen etter behandlingen.

Brukstabell

G 	 MAKS (g)	 (Sek)
	750 ml 	10-20
	750 ml 	10-20
	 MAKS (g)	 (Sek)
	750 ml 	10-20

For å bruke din Express Serve

Bruksdiagram og brukerinstruksjoner

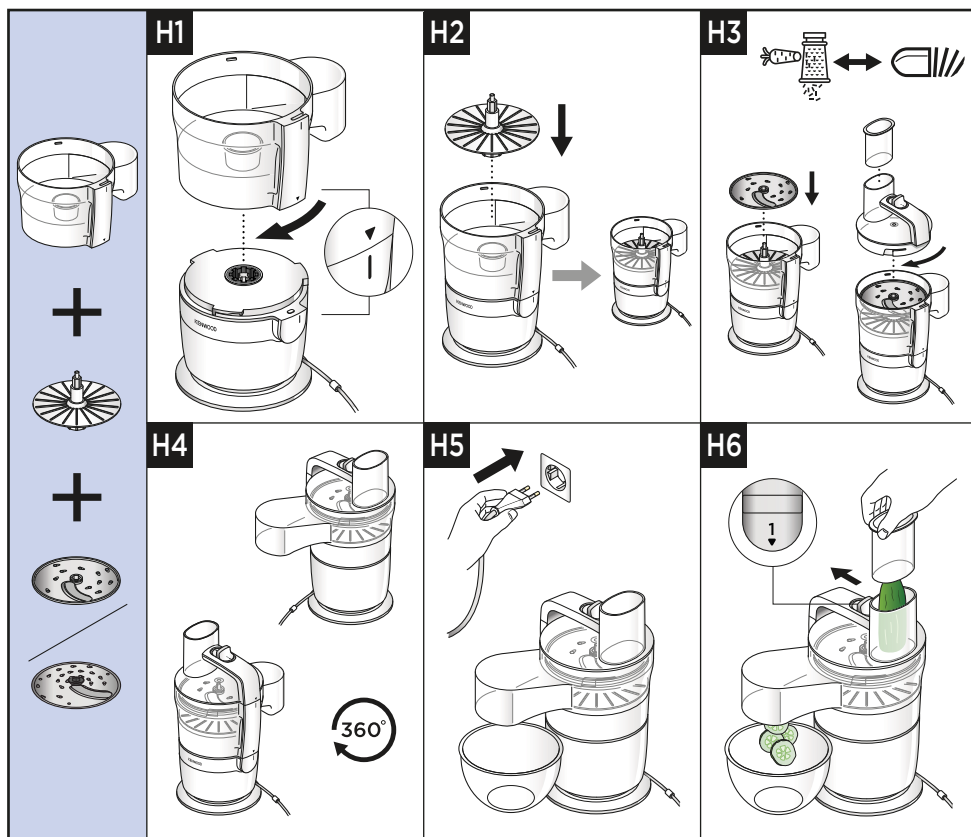











Viktig

- Ikke bruk for mye kraft når du bruker tilbehøret.
- Hvis maten ikke kommer ut av matuttaket, slå av og kontroller at maten ikke tetter seg under platen og at slingerplaten er montert. Fjern all fastklemt mat før du fortsetter prosesseringen.

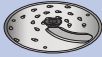
- 1 Monter bollen på strømenheten, vri i retning med klokken for å låse.
- 2 Monter slyngelplaten og den nødvendige skiven.
- 3 Sett på lokket.
- 4 Ha maten i materøret.
- 5 Sett i kontakten, velg hastighet 1 og trykk jevnt ned med skyveren.

Brukstabell

I 	 MAKS (g)	 (Sek)
		120
		120
	 MAX (g)	 (secs)
		120

For å bruke din Personal Blender/Hakker

Bruksdiagram og brukerinstruksjoner

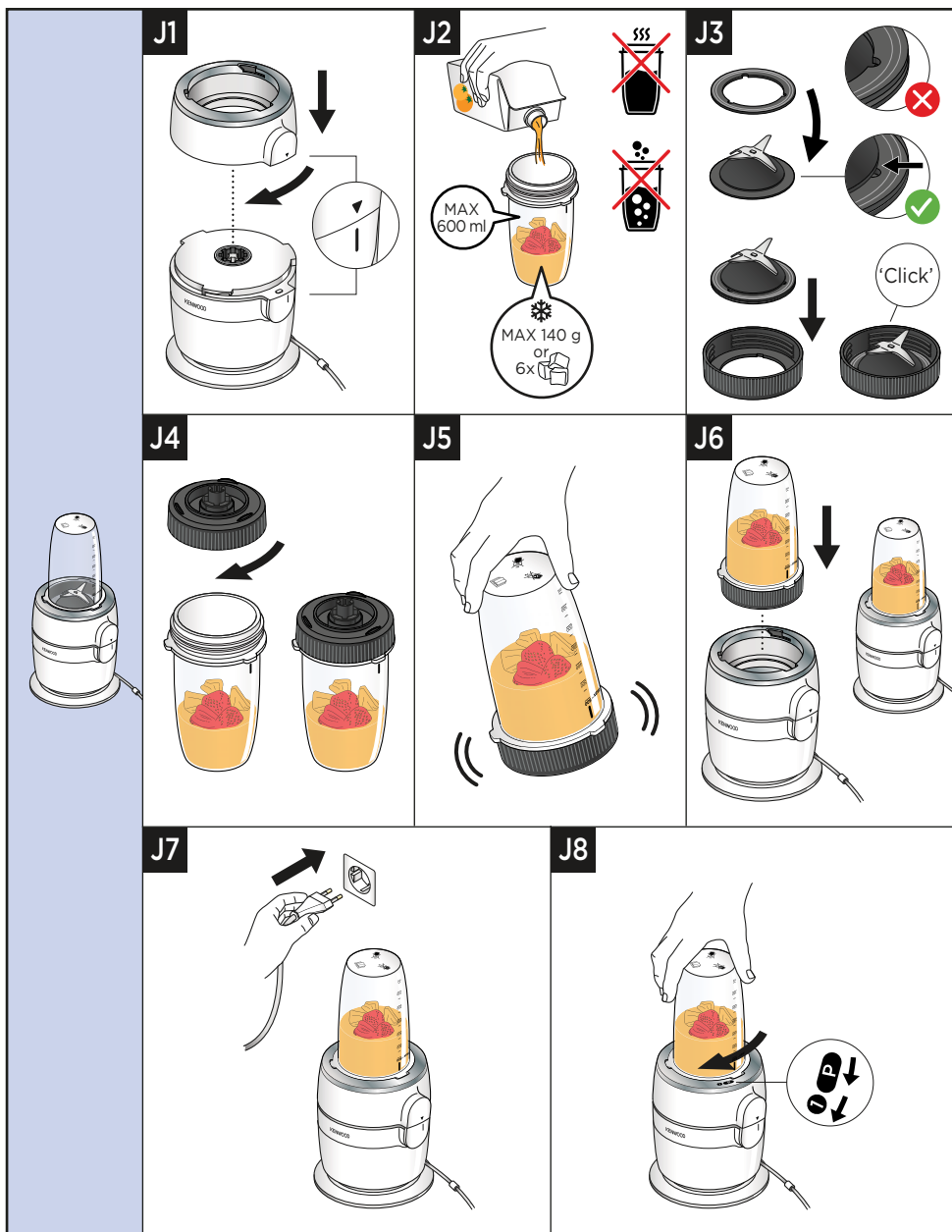

For å bruke din Personal Blender/Hakker

Bruksdiagram og brukerinstruksjoner

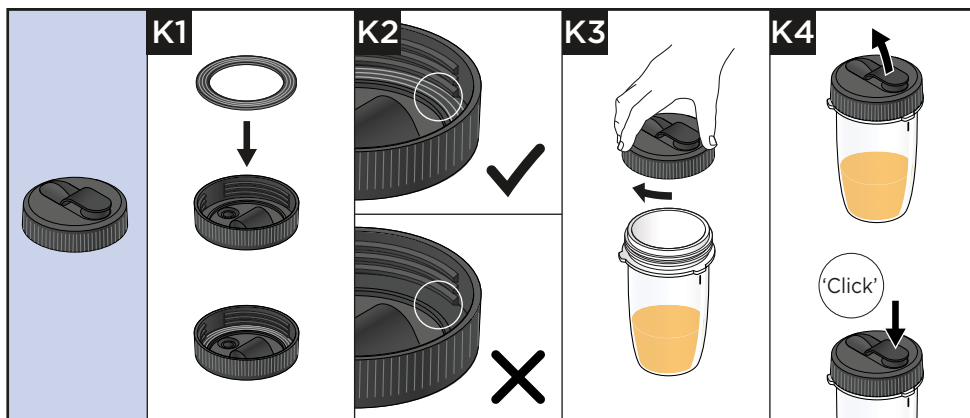

Viktig

- Den personlige blender-/hakkerbasen må monteres på strømenheten før den personlige blenderen/hakkeren monteres.
- Ikke blande frosne ingredienser uten væske (bortsett fra isbiter).
- Aldri blande frossen frukt eller grønnsaker som er større enn 3 cm X 3 cm biter.
- Lekkasje vil oppstå hvis tetningsringen er skadet eller feilmontert.
- Bland aldri frosne ingredienser som har dannet en fast masse.
- For best mulig blandingsytelse, tilsett alltid is/frosne ingredienser i flasken først.
- **Alltid** fjern steiner i tørket frukt før du hakker den.

- 1 Monter den personlige blender/hakkerbollen på strømenheten, vri i retning med klokken for å låse.
- 2 Tilsett ingredienser i koppen, opp til 600 ml-merket.
- 3 Monter tetningsringen på bladenheten, og sørg for at tetningen er sikkert plassert i det rillede området.
- 4 Senk bladenheten sakte inn i bladholderen og klikk den fast på plass.
- 5 Hold undersiden av den monterte bladholderen og senk den ned på koppen med knivene nede.
- 6 Skru den monterte bladholderen fast på koppen - vri i retning med klokken for å låse.
- 7 Rist for å fordele ingrediensene.
- 8 Senk tilbehøret ned på strømenheten.
- 9 Sett i støpselet. For å velge pulseringshastighet, vri i retning med klokken (mot P) og slipp opp tilbehøret. For å velge kontinuerlig hastighet, vri tilbehøret i retning med klokken (mot 1) helt til det klikker på plass.











Drikkelokk

- 10 Monter tetningsringen på drikkelokket, og sørg for at tetningen er riktig plassert i det rillede området.
- 11 For å bruke drikkelokket, skru av den monterte bladholderen fra koppen. Sett på drikkelokket ved å vri det i retning med klokken.
- 12 Når du vil drikke, er det bare å vippe opp lokket. Drikken kan drikkes rett fra flasken.
- 13 Sett på lokket på nytt igjen etter at du har drukket. Trykk godt for å feste det.

Råd og tips

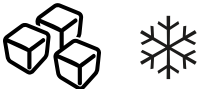
- Merk at når koppen er fylt til maksimal kapasitet (600 ml), er dette omtrent to porsjoner.
- Hvis du ikke har tenkt å drikke drikken med en gang, oppbevar den i kjøleskapet og drikke den innen 24 timer.
- Kontroller at drikken er tynn nok til å kunne drikkes fra påfyllingslokket. Hvis du vil ha en tynnere drikk, tilsetter du mer væske.
- Etter blanding kan det hende at noen drikker ikke er helt jevne på grunn av frø eller konsistensen på ingrediensene.
- Noen drikker skiller seg når de blir stående, og derfor er det best å drikke dem med en gang. Drikker som har skilt seg, bør røres før du drikker dem.
- Hold alltid koppen stående rett opp og ned når drikkelokket er satt på plass.

Brukstabell

L		 MAX (g)		 (Sek)
	 3 cm	600 ml	1	30-60
		100 g	10-20	P
		X 6 120-140 g	P	10-20
		50 g	P	10-20
		100 g	1	30-60
		50 g	P	10

Oppskrift

Pesto

60 g fersk basilikum
1 fedd hvitløk
25 g pinjekjerner
25 g revet parmesanost
110g olivenolje
Salt - etter smak
Pepper - etter smak

- 1 Ha alle ingrediensene i blender-/hakkerkoppen. Pulser 5 ganger, etterfulgt av kontinuerlig prosessering til ønsket konsistens er nådd (omtrent 25 sekunder).

Sviskemarmelade

300g honning
40g svsker
70 ml vann

- 1 Legg alle ingrediensene i blender-/hakkerkoppen. Oppbevares i kjøleskapet over natten. (Ikke oppbevar ingrediensene i koppen i mer enn 24 timer).
- 2 Behandle i 4 sekunder med pulseringshastighet. Må brukes umiddelbart.

Justering av ledning

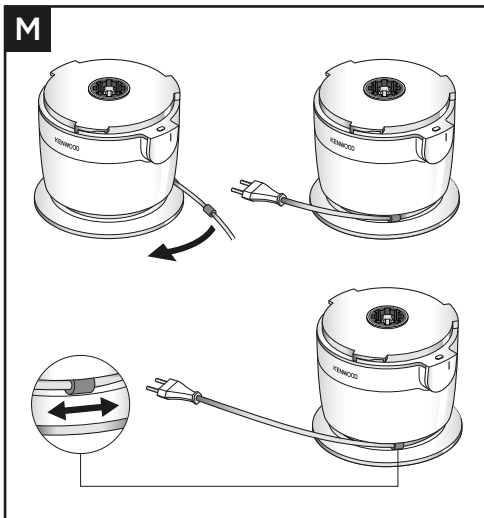

- Pakk ledningen rundt bunnen av processoren til ønsket lengde og klem ledningen sammen med ledningsklipsen.

Oppbevaring

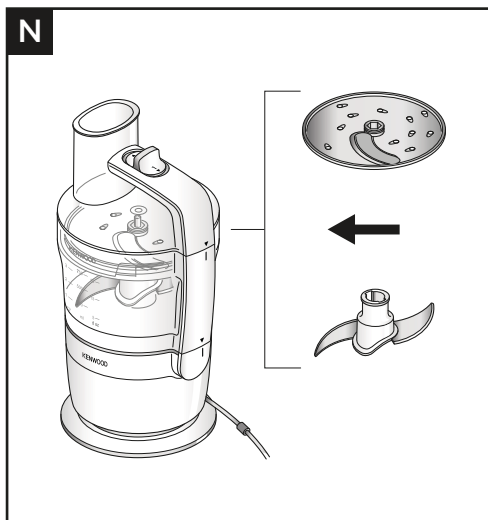

- Etter bruk kan knivbladet og den ene skiven oppbevares sammen i bollen.
- Den andre skiven (hvis den følger med) kan oppbevares i ekspressserveringsbollen.
- Ikke bruk kjøkkenmaskinen med både knivbladet og skiven montert. Bruk kun et redskap om gangen.

Service og kundetjeneste

- Hvis du har problemer med å bruke apparatet ditt, må du sjekke «Feilsøkingsveiledningen» i håndboken eller gå til www.kenwoodworld.com før du kontakter oss for hjelp.
- Vennligst merk at produktet ditt dekkes av en garanti som overholder alle lovforskrifter angående eksisterende garanti- og forbrukerrettigheter i landet der produktet ble kjøpt.
- Hvis Kenwood-produktet ditt har funksjonssvikt eller du finner defekter på det, må du sende det eller ta det med til et autorisert KENWOOD-servicesenter. Du finner oppdatert informasjon om hvor ditt nærmeste autoriserte KENWOOD-servicesenter er, på www.kenwoodworld.com eller på nettstedet for landet ditt.
- Designet og utviklet av Kenwood i Storbritannia.
- Laget i Kina.



VIKTIG INFORMASJON OM KORREKT KASTING AV PRODUKTET I HENHOLD TIL EU-DIREKTIVET OM ELEKTRISK OG ELEKTRONISK UTSTYR SOM AVFALL (WEEE)

På slutten av levetiden må ikke produktet kastes som vanlig avfall.

Det må tas med til et lokalt kildesorteringssenter eller til en forhandler som tilbyr denne tjenesten.

Feilsøkingeveiledning

Problem	Årsak	Løsning
Prosessoren fungerer ikke.	Ikke strøm.	Sjekk at støpselet på prosessoren sitter i kontakten.
	Bollen er ikke festet riktig til strømenheten.	Prosessoren vil ikke fungere hvis bollen eller lokket ikke er riktig montert i låsen.
	Bollelokket er ikke låst riktig.	Kontroller at bollen og lokket er riktig innrettet og låst sammen.
Prosessoren stanser midt i prosessen.	Prosessoren er overfylt / maksimal kapasitet overskredet.	Sjekk maksimalkapasiteten som står oppført i tabellen for anbefalt bruk.
	Lokket er låst opp.	Kontroller at lokket er låst fast på riktig måte.
Kan ikke passe bollen til bunnen, med lokket på.	På/Av bryteren er i 'På' posisjon.	Flytt bryteren til "av" posisjon.
Maten kommer ikke ut av Express Serve.	Slingerplaten er ikke montert under rive-/skjæreskiven.	Monter slingerplaten.
Oppskåret eller revet mat som er skadet av knivbladet.	Betjenes med knivbladet og skiven montert i bollen.	Fjern knivbladet før du bruker rive-/skjæreskiven.
Enheten er ustabil/ tunge vibrasjoner og bevegelse.	For lang elting av deig.	Ikke elte deiger i mer enn 30 sekunder og ikke overskrid den maksimale mengden anbefalt i brukstabellen.
	Prosessoren er overfylt / maksimal kapasitet overskredet.	For best mulig resultat, bruk "Pulsring" først for å bryte opp ingrediensene og deretter fortsett med å behandle på maksimal hastighet.
	Elt deigen på nytt.	Bruk håndtaket på lokket for å støtte hvis apparatet begynner å bevege seg på benkeplaten.
	Klissete frukt/ingredienser slik som dadler behandles.	Elt deigen på nytt kun for hånd. Det å elte deigen på nytt igjen i bollen anbefales ikke, da det kan føre til at prosessoren blir ustabil.
Kraftig sprut eller ingredienser som kastes ut av materøret.	Skyver er ikke montert.	Monter alltid skyveren når du elter deig, bakverk og kaker for å unngå sprut fra materøret.
Dårlig ytelse ved knivbladet og skiven.	Se avsnittet Hint og tips og følg anbefalingen i bruksoversikten.	

Feilsøkingeveiledning

Problem	Årsak	Løsning
Personlig Blender/ hakker fungerer ikke.	Personlig Blender/hakker er ikke låst på riktig måte Personlig blender/ hakkerbase er ikke låst på riktig måte	Den personlige blenderen/hakkeren vil ikke fungere hvis den er feil montert i sperren.
Personlig blender/ hakker lekker fra bladmonteringsenhet.	Tetningsringen er ikke satt på. Tetningsringen er feil satt på. Tetningsringen er skadet. Bladholder ikke fullstendig/ skikkelig lukket.	Kontroller at bladholderen er skrudd helt fast. Kontroller at tetningen er riktig montert i sporet i henhold til diagram J3 og ikke er skadet. Hvis du trenger en ny tetningsring, se Service og kundetjeneste.
Personlig blender/ hakker lekker fra drikkelokket.	Ulåst lokk.	Kontroller at lokket er riktig låst.

Suomi

- Tärkeitä turvallisuustietoja [265-267](#)
- Ennen verkkovirtaan liittämistä [267](#)
- Hoitaminen ja puhdistaminen [268-269](#)
- Osaluettelo [270-271](#)
- Yleiskoneen käyttö - Veitsiterä [272-274](#)
 - Käyttökaaviot ja -ohjeet [272-273](#)
 - Käyttökaavio [273](#)
 - Resepti [274](#)
- Yleiskoneen käyttö - Levyt [274-275](#)
 - Käyttökaaviot ja -ohjeet [274-275](#)
 - Käyttökaavio [275](#)
- Express Serve -lisälaitteen käyttö [276-277](#)
 - Käyttökaaviot ja -ohjeet [276](#)
 - Käyttökaavio [277](#)
- Henkilökohtaisen sekoittimen/leikkurin käyttö [278-282](#)
 - Käyttökaaviot ja -ohjeet [278-280](#)
 - Käyttökaavio [281](#)
 - Resepti [282](#)
- Johdon säätö [282](#)
- Säilytys [283](#)
- Huolto ja asiakaspalvelu [284](#)
- Ongelmanratkaisuohteita [285-286](#)

Tärkeitä turvallisuustietoja



- Lue nämä ohjeet huolella ja säilytä ne myöhempää tarvetta varten.
- Poista ennen ensimmäistä käyttöä kaikki pakkausmateriaali ja markkinointikirjallisuus sekä muoviset teränsuojukset. Pese osat: ks. "Hoitaminen ja puhdistaminen".
- Jos virtajohto tai pistoke on vaurioitunut, sen saa vaihtaa ainoastaan Kenwood tai Kenwoodin valtuutettu huoltoedustaja vaarojen välttämiseksi.
- **ÄLÄ koske teräviin teriin.** Terät ja levyt ovat hyvin teräviä, käsittele niitä varoen. **Kun käsittelet leikkuuteriä, tyhjennät kulhon tai puhdistat sen, tartu aina yläosaan kauas itse terästä.**
- **Keittiökoneen kulho ja Express Serve -lisälaite eivät sovellu jääpaloille.**
- Tarkista aina, että kulho ja kansi ovat kunnolla paikoillaan ja kiinni ennen kuin nostat tai kannat laitetta kannen kahvasta.
- **Älä** käsittele kuumia aineksia missään toimitukseen sisältyvissä astioissa, henkilökohtainen sekoitin mukaan lukien. Kuumat nesteet voivat ryöpsähtää ulos laitteesta äkillisen höyrystymisen takia.
- **Älä** koskaan jätä laitetta valvomatta, kun se on toiminnassa.
- **Älä** siirrä laitetta sen ollessa käynnissä.
- **Älä** ylitä käyttösuositustaulukossa mainittuja enimmäistehoja.
- **Älä käytä laitettasi taikinaa käsitellessäsi yli 30 sekuntia ilman 5 minuutin taukoa. Pidempiaikainen yhtämittainen käsittely voi vaurioittaa laitettasi.**
- **Poista** aina veitsen terä ja levyt ennen kuin kaadat sisällön keittiökoneen kulhosta.
- Pidä kädet ja keittiövälineet poissa keittiökoneen kulhosta silloin, kun laite on kytkettynä virtalähteeseen.
- Jos ruoka tarvitsee painaa alas keittiökoneen kulhoon, käytä sopivaa keittiövälinettä, esimerkiksi lastaa.
- **Älä** koskaan paina ruokaa syöttösuppilon sormien avulla. Käytä aina mukana toimitettua paininta.
- Katkaise **aina** laitteesta virta ja irrota virtapistoke pistorasiasta ennen laitteen jättämistä ilman valvontaa sekä ennen kokoamista, purkamista tai puhdistamista.
- VARO: Odota, että lisälaite/terät ovat täysin pysähtyneet ennen kuin poistat kulhon kannen.
- **Älä** käytä liiallista voimaa työntäessäsi aineksia syöttöputkeen – laite voi vaurioitua.
- **Älä** käynnistä tai sammuta yleiskonetta kannen lukosta, vaan käytä aina virtakytkintä.
- **Älä** käytä keittiökonetta niin, että sekä veitsiterä että levy ovat kiinnitettyinä. Käytä ainoastaan yhtä työvälinettä kerrallaan.
- **Tämä laite vaurioituu ja voi aiheuttaa henkilövahingon, jos lukitusmekanismiin kohdistetaan suuri voima.**
- **Älä** koskaan kiinnitä laitteeseen muita kuin sen omia osia.
- **Älä** käytä vaurioitunutta laitetta. Toimita se tarkistettavaksi tai korjattavaksi. Lisätietoja on huolto ja asiakaspalvelu -kohdassa.

- Älä kastele virtayksikköä, sähköjohtoa tai pistoketta.
- Varo, ettei virtajohto roiku pöydän tai työtason reunan alla tai kosketa kuumiin pintoihin.
- Lapsia tulee pitää silmällä sen varmistamiseksi, että he eivät leiki laitteella.
- Tätä laitetta ei saa antaa lasten käyttöön. Pidä laite ja sen virtajohto poissa lasten ulottuvilta.
- Fyysisesti, sensorisesti tai henkisesti rajoittuneet tai kokemattomat henkilöt voivat käyttää laitteita, jos heidät on koulutettu käyttämään niitä turvallisesti ja he ymmärtävät käyttämisen aiheuttamat vaarat.
- Käytä laitetta ainoastaan sille tarkoitettuun kotitalouskäyttöön. Kenwood-yhtiö ei ole korvausvelvollinen, jos laitetta on käytetty väärin tai näitä ohjeita ei ole noudatettu.
- Laitteen väärinkäyttö voi aiheuttaa vammoja.

Express Serve

- Vältä koskemasta liikkuviin osiin. Pidä sormet poissa poistoaukon luota.
- Älä käytä laitetta ilman nestelinkolevyä. **Jos nestelinkolevy ei ole paikallaan, ainesosat jäävät kiinni levyn pohjaan, jolloin ne eivät poistu ruoan poistoaukosta. Tällöin lisälaite vaurioituu.**
- Jos poistoaukosta ei tule ainesta ulos, sammuta laite ja tarkista, että käsiteltävä aines ei ole aiheuttanut tukosta raastinterän ja nestelinkolevyn alapuolelle. Poista kaikki tukoksen aiheuttanut aines ennen käsittelyn jatkamista.
- **Älä käytä Express Serve -lisälaitetta kahta minuuttia kauemmin kerrallaan. Anna laitteen jäähtyä kahden minuutin ajan kahden minuutin käyttöjaksojen välillä.**

Henkilökohtaisen sekoittimen/leikkurin turvallisuus

-  **ÄLÄ** käsittele kuumia aineksia.
-  **ÄLÄ** sekoita hiilihapotettuja nesteitä.
- **PALOVAMMAN VAARA:** Kuumien ainesten täytyy antaa jäähtyä huoneenlämpötilaan ennen kuin ne asetetaan sekoituskannuun tai ennen kuin ne sekoitetaan.
- Älä säilytä aineksia kupissa yli 24 tunnin ajan.
- Käsittele **aina** teriä varovaisesti. Vältä koskettamasta terien reunoja puhdistaussasi niitä.
- **Älä** koskaan käytä sekoitinta/leikkuria tyhjänä.
- Smoothie-reseptit – älä koskaan sekoita jäisiä aineksia, joista on tullut kiinteää massa pakastamisen aikana. Paloittele massa ennen kuin lisäät sen sekoituskannuun.
- Käytä ainoastaan teräkokonaisuuden mukana toimitettua sekoituskannua.
- **Älä** koskaan juo kuumia nesteitä kupista.
- Jos juot kannen läpi, varmista, että juoma on tasaista. Parhaiden tulosten saavuttaminen voi vaatia kokeilemista. Varsinkin kovia tai raakoja aineksia käytettäessä osa niistä voi jäädä käsittelemättä.
- **Älä** sekoita pakastettuja aineksia ilman nestettä (jäähaloja lukuun ottamatta).
- **Älä koskaan** sekoita pakastettuja hedelmän- tai vihannestenpalasia, jotka ovat suurempia kuin 3 x 3 cm:n kuutiot.

- **Älä koskaan** sekoita kuivia aineksia (esim. mausteita, pähkinöitä) tai käytä sekoitinta/leikkuria tyhjänä.
- **Älä koskaan** kiinnitä teräkokonaisuutta moottoriosaan ilman että sekoituskannu on kiinnitettynä.
- Poista **aina** kivet kuivahedelmistä ennen niiden pilkkomista.

Tehonkulutus

- Kun laite ei ole toiminnassa
 - Automaattinen siirtyminen OFF-tilaan: Ei käytössä
 - Off-tilan tehonkulutus: $\leq 0,3$ W.

Ennen verkkovirtaan liittämistä

- Varmista, että koneen pohjassa ilmoitettu jännite vastaa käytettävän verkkovirran jännitettä.
- Tämä laite täyttää EU-asetuksen 1935/2004 elintarvikkeiden kanssa kosketuksiin joutuvista materiaaleista ja tarvikkeista.











Ennen ensimmäistä käyttökertaa

- 1 Poista muovinen teränsuojus veitsiterästä. Varo: terät ovat hyvin teräviä. Tämä suojus tulee hävittää, koska se on tarkoitettu ainoastaan suojaamaan terää valmistuksen ja kuljetuksen aikana.
- 2 Pese osat: ks. "Hoitaminen ja puhdistaminen".

Hoitaminen ja puhdistaminen

			
	X	X	✓
	✓	✓	X
	✓	✓	X
	✓	✓	X
	✓	✓	X
	✓	✓	X
	✓	✓	X
	✓	✓	X
	✓	✓	X

Hoitaminen ja puhdistaminen

			
	X	X	✓
	✓	✓	X
	✓	✓	X
	✓	✓	X
	✓	✓	X
	✓	✓	X
	✓	✓	X

- Katkaise virta ja odota, että työväline/terät pysähtyvät ja irrota laite pistorasiasta ennen puhdistusta.
- Pyyhi moottoriosia kostealla kankaalla ja kuivaa se sen jälkeen. Varmista, että lukitusalueella ei ole ruoan jäämiä.
- Älä koskaan upota moottoriyksikköä veteen.
- Käsittele teriä ja leikkuulevyjä varoen – ne ovat erittäin teräviä.
- Jos peset henkilökohtaisen sekoittimen/leikkurin terät käsin, ne tulee harjata puhtaiksi ja huuhdella juoksevan veden alla.

Osaluettelo

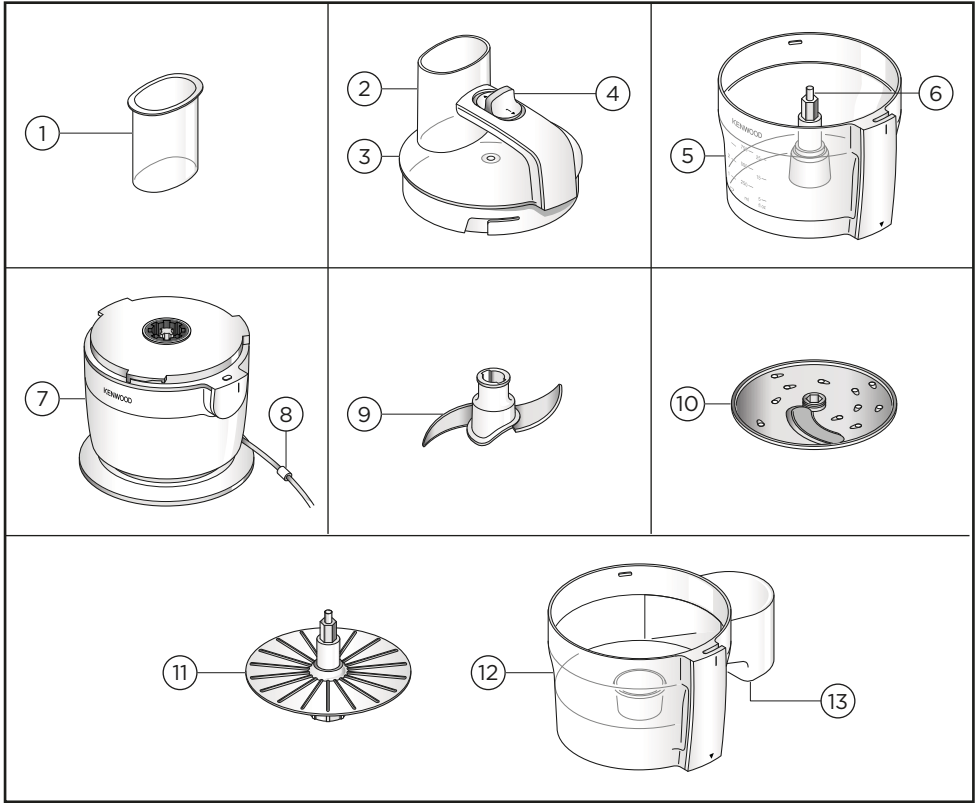

* Jos tämä sisältyy toimitukseen

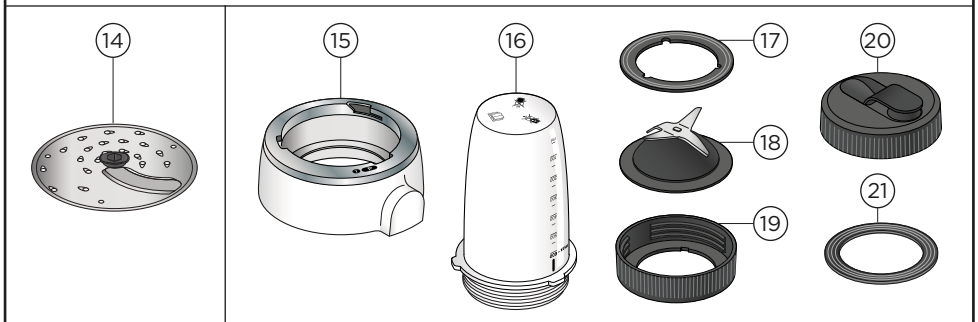

Selite

Yleiskone

- ① Painimet
- ② Syöttösuppilo
- ③ Kansi
- ④ On/Off -virtakytkin + sykäys
- ⑤ Kulho
- ⑥ Kulhokäytössä
- ⑦ Virtayksikkö
- ⑧ Johdon pidike
- ⑨ Hienonnusterä
- ⑩ Viipalointi/raastinterä 4 mm

Express Serve

- ⑪ Nestelinkolevy
- ⑫ Express Serve -kulho
- ⑬ Ruoan poistoaukko

Disc

- ⑭ Viipalointi/raastinterä 2 mm (jos sisältyy toimitukseen)

Henkilökohtainen sekoitin/leikkuri

- ⑮ Henkilökohtaisen sekoittimen/leikkurin pohjaosa
- ⑯ Sekoituskannu
- ⑰ Tiivisterengas
- ⑱ Teräyksikkö
- ⑲ Teränpidin
- ⑳ Juomakansi
- ㉑ Juomakannen tiivisterengas

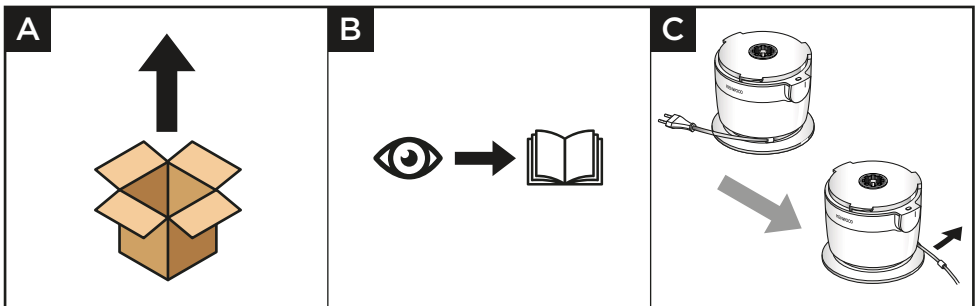

Yleiskoneen käyttö - Veitsiterä

Käyttökaaviot ja -ohjeet

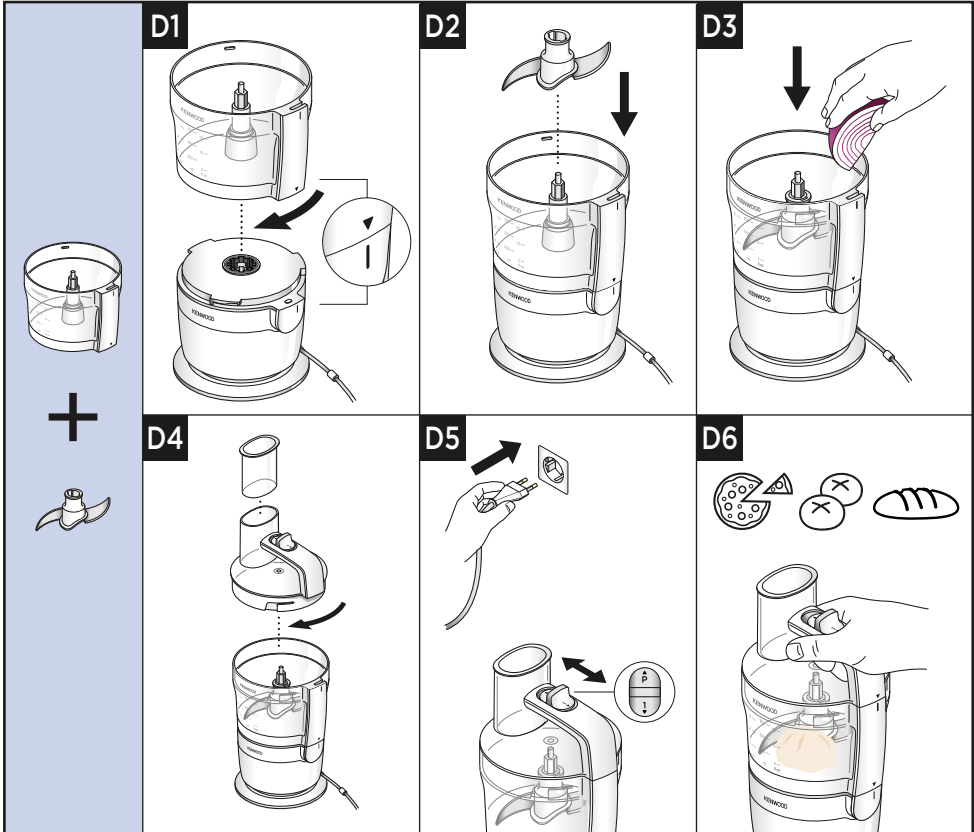

Tärkeää

















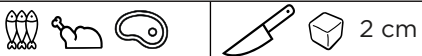
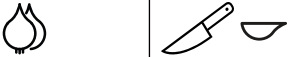
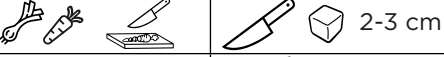
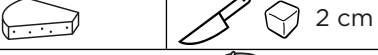





- Keittiökoneesi ei sovellu kahvipapujen ja mausteiden murskaamiseen tai jauhamiseen, kidesokerin muuntamiseen hienosokeriksi tai jääpalojen käsittelyyn.
- Kun käytät mausteena manteliesanssia tai -aromia, varo että aine ei kosketa muoviosiin, sillä siitä jää pysyviä jälkiä.
- Aseta kulho ja varuste aina paikalleen yleiskoneeseen ennen aineosien lisäämistä.
- Älä käytä kantta yleiskonetta käyttäessäsi.
- Yleiskone ei toimi, jos kulho tai kansi ei ole kunnolla paikallaan. Tarkista, että syöttöputki ja kulhon kahva ovat oikealla puolella.
- Sammuta virta ja irrota pistoke pistorasiasta aina ennen kannen irrottamista.
- Älä käsittele leipätaikinaa yli 30 sekunnin ajan.
- Vaivaa leipätaikinaa vain käsin. Uudelleen vaivaaminen kulhossa ei ole suositeltavaa, koska sen seurauksena yleiskoneesta voi tulla epävakaa.
- Pidä aina kiinni yksikön kahvasta käsitellessäsi taikinaa.

- 1 Kiinnitä kulho moottoriosaan ja lukitse se kääntämällä sitä myötäpäivään.
- 2 Kiinnitä veitsiterä käyttöakselille.
- 3 Lisää ainekset keittiökoneen kulhoon.
- 4 Kiinnitä kansi.
- 5 Liitä laite pistorasiaan.
- 6 Kytke laitteen virta tai käytä sykäystoimintoa.

Vihjeitä ja neuvoja

- Saat aikaan lyhyitä sykäyksiä käyttämällä (P)-sykäystoimintoa. Sykäys toimii pitäessäsi säädintä paikoillaan.
- Jotkin ruoka-aineet voivat värjätä muovia. Tämä on täysin normaalia eikä vahingoita muovia tai vaikuta ruoan makuun. Voit poistaa värjäyivät hankaamalla muovia kasviöljyyn kastetulla kankaalla.
- **Leipätaikina** - Laita ensin kuivat ainekset kulhoon ja lisää sen jälkeen neste. Käsittele aineksia niin kauan, että syntyy sileä, joustava taikinapallo.
- Tue laitetta kannen kahvasta, jos laite alkaa liikkua työtasolla.
- Jos haluat karkeamman koostumuksen, käytä sykäystoimintoa.
- Varo käsittelemästä ruoka-aineita liikaa.
- Kun valmistat leivonnaisia, kuutioi kovettunut rasva ensin 2 cm:n kuutioiksi.

Käyttökaavio

E		 MAX (g)	 (Sec)
		20-30	10-20
		200	30
		150	20-30
		300	10/P
		200	P
		250	15-20
		100-200	20
		400	60
		x3  + 300 ml 	45-60
		250 g  + 150 g 	30
		250 g 	10-30
		 x3 +  150 g +  150 g +  18-22°C +  150 g	20

Reseptit

Luumumarinadi

400 g hunajaa

40 g luumuja

50 ml vettä

- 1 Laita jääkaappiin yöksi.
- 2 Käytä 4 sekunnin ajan sykäystoimintoa.

Yleiskoneen käyttö - Levyt

Käyttökaaviot ja -ohjeet

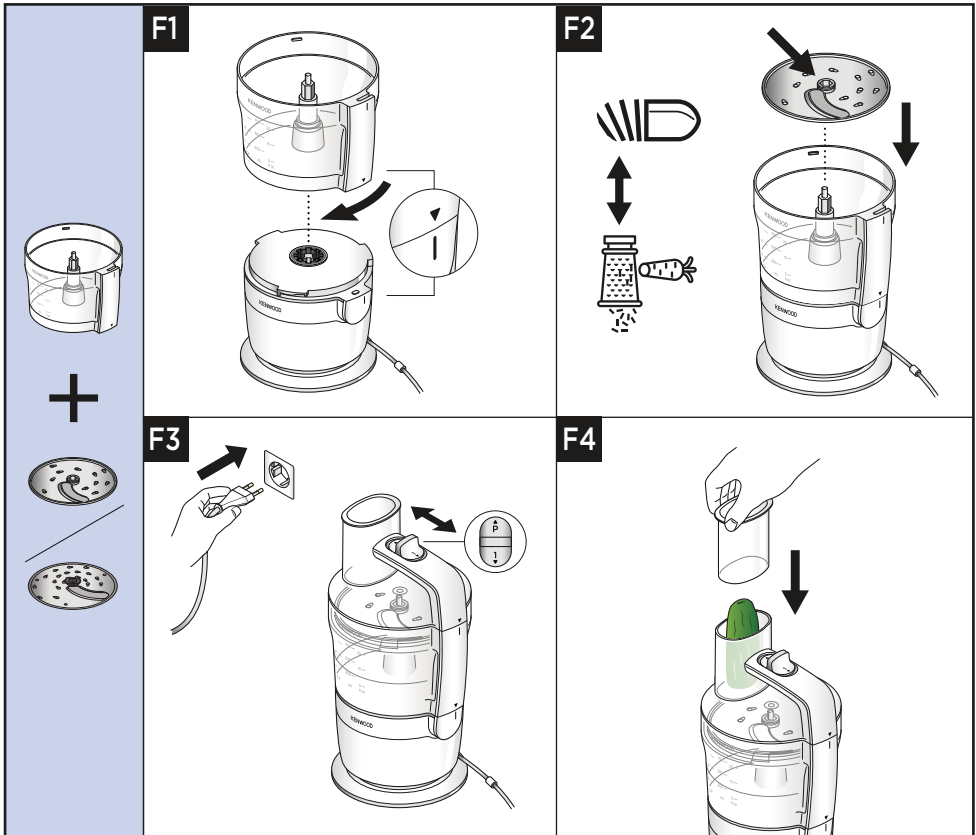

Tärkeää













- Älä työnnä sormiasi syöttöputkeen.

- 1 Kiinnitä kulho moottoriosaan ja lukitse se kiertämällä sitä myötäpäivään.
- 2 Tartu levyn keskiosaan ja aseta se akseliin oikea puoli ylöspäin.
- 3 Aseta kansi paikalleen.
- 4 Pane elintarvikkeet syöttöputkeen.
- 5 Liitä laite pistorasiaan, kytke nopeudelle 1 ja työnnä ainekset alas painimella.

Vihjeitä ja neuvoja

- Käytä tuoreita raaka-aineita.
- Älä hienonna elintarvikkeita liian pieniksi. Täytä syöttöputki koko leveydeltään elintarvikkeilla (älä täytä liian täyteen), tämä estää elintarvikkeita liukumasta sivuttain käsittelyn aikana.
- Pystysuunnassa asetetut ainekset tulevat ulos lyhyempinä kuin vaakasuunnassa asetetut.
- Levyyntai kulhoon jää aina hieman tähteitä.

Käyttökaavio

G		 MAX (g)	 (Sec)
		750 ml 	10-20
		750 ml 	10-20
		 MAX (g)	 (secs)
		750 ml 	10-20

Express Serve -lisälaitteen käyttö

Käyttökaaviot ja -ohjeet

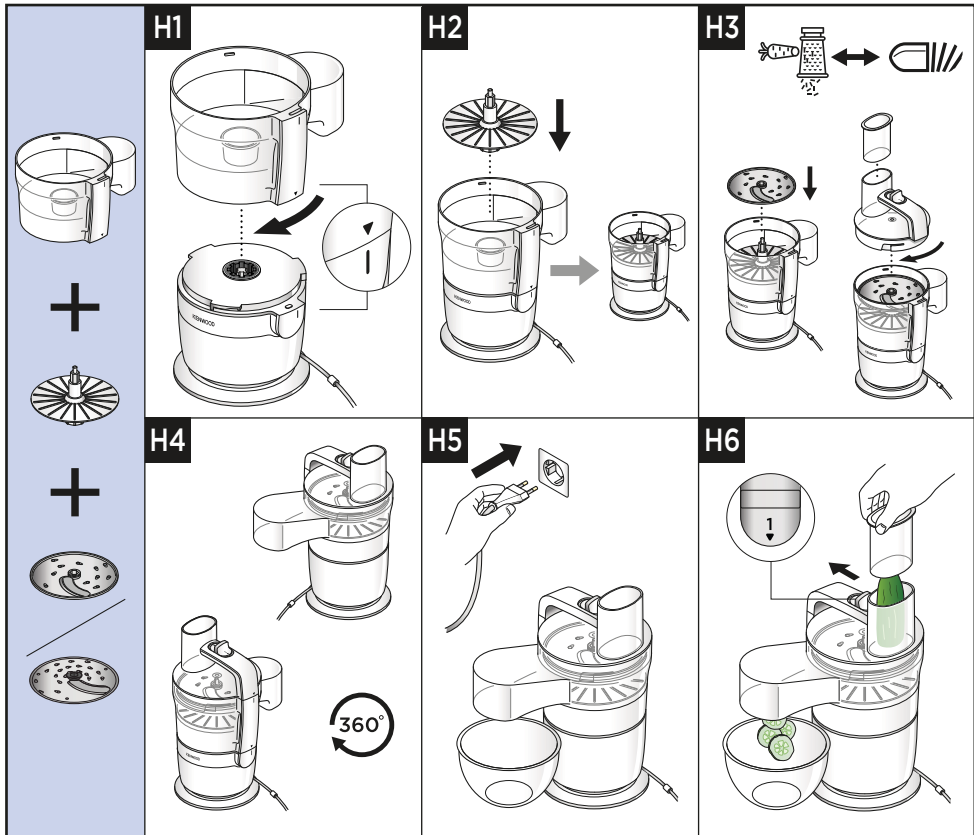











Tärkeää

- Älä käytä liiallista voimaa lisälaitetta käyttäessäsi.
- Jos ruoka ei poistu ruoan ulostuloaukosta, sammuta laite ja tarkista, että ruoka ei ole jäänyt kiinni linkolevyn alle ja että linkolevy on kiinnitetty. Poista kaikki kiinni jääneet ainekset ennen kuin jatkat käsittelyä.

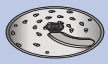
- 1 Kiinnitä kulho moottoriosaan ja lukitse se kääntämällä sitä myötäpäivään.
- 2 Kiinnitä linkolevy ja tarvittava levy.
- 3 Aseta kansi paikalleen.
- 4 Pane elintarvikkeet syöttöputkeen.
- 5 Liitä laite pistorasiaan, kytke nopeudelle 1 ja työnnä ainekset alas painimella.

Käyttökaavio

I 	 MAX (g)	 (Sec)
		120
		120
	 MAX (g)	 (Sec)
		120

Henkilökohtaisen sekoittimen/leikkurin käyttö

Käyttökaaviot ja -ohjeet

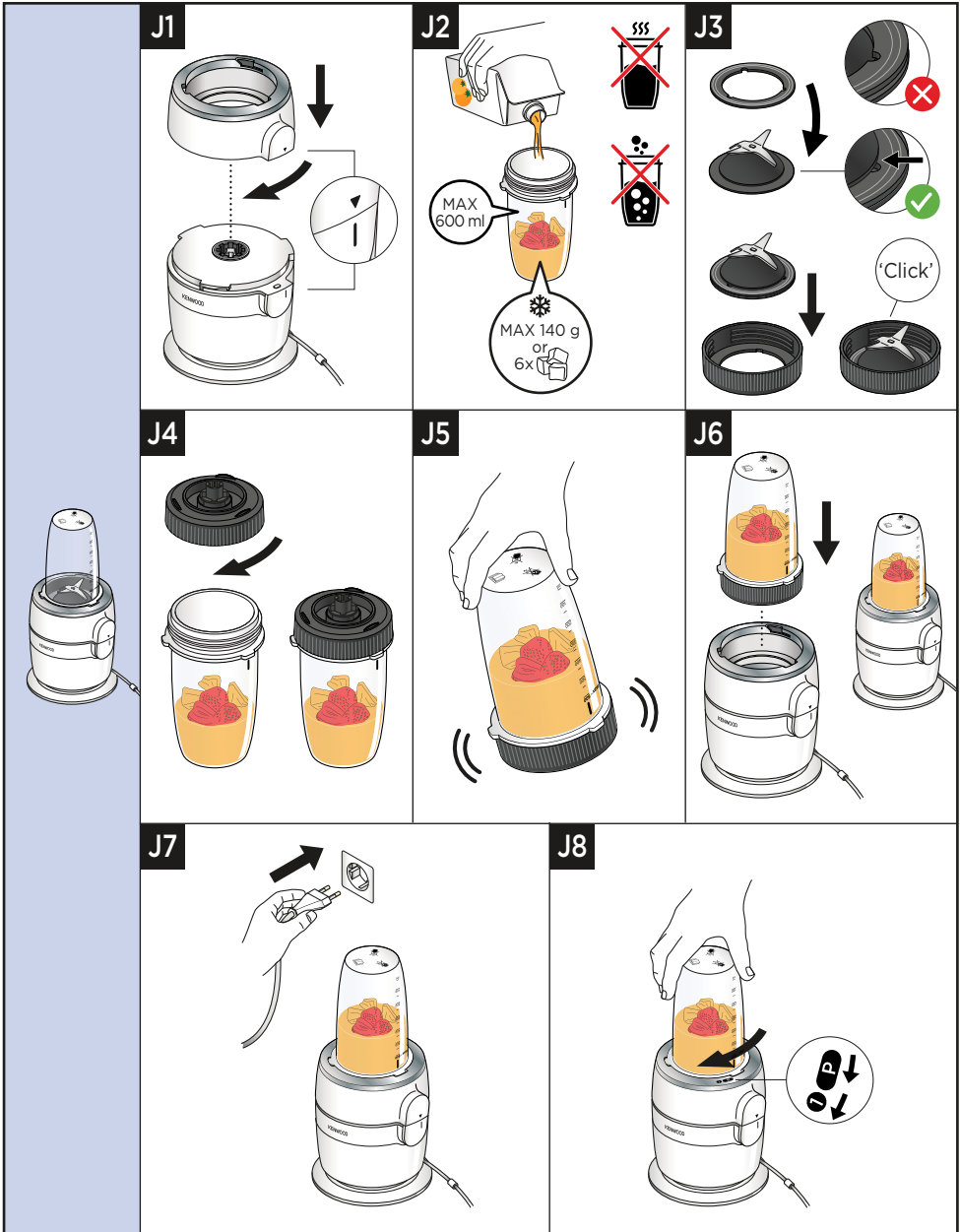

Henkilökohtaisen sekoittimen/leikkurin käyttö

Käyttökaaviot ja -ohjeet

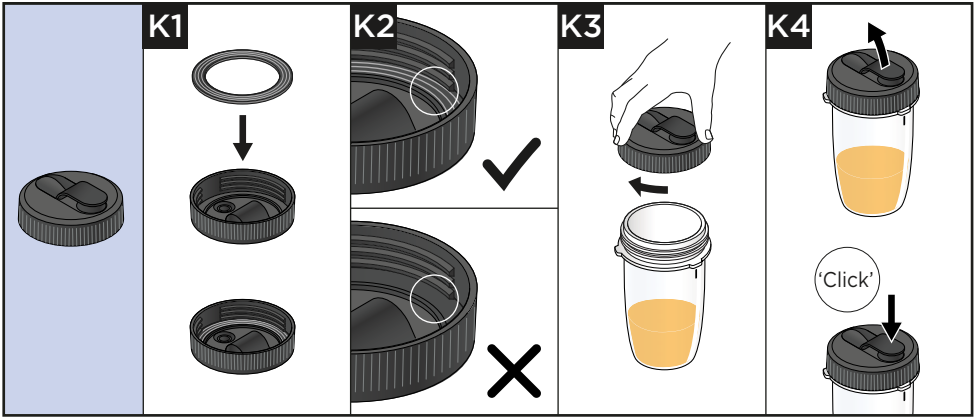

Tärkeää

- Henkilökohtaisen sekoittimen/leikkurin pohjaosa täytyy kiinnittää moottoriosaan ennen henkilökohtaisen sekoittimen/leikkurin kiinnittämistä.
- Älä sekoita pakastettuja aineksia ilman nestettä (jääpaloja lukuun ottamatta).
- Älä koskaan sekoita pakastettuja hedelmän- tai vihannestenpalasia, jotka ovat suurempia kuin 3 x 3 cm:n kuutiot.
- Jos tiivistysrenkas on vaurioitunut tai asennettu väärin, syntyy vuoto.
- Älä koskaan sekoita pakastettuja aineksia, joista on tullut kiinteää massaa.
- Parhaan suorituskyvyn sekoituksessa saat sillä, että lisäät aina jään/pakastetut ainekset pulloon ensin.
- Poista **aina** kivet kuivahedelmistä ennen niiden pilkkomista.

- 1 Kiinnitä henkilökohtaisen sekoittimen/leikkurin pohjaosa moottoriosaan ja lukitse se kiertämällä sitä myötäpäivään.
- 2 Lisää aineksia sekoituskannuun korkeintaan 600 ml:n tason merkkiin asti.
- 3 Kiinnitä tiivisterengas teräyksikköön. Varmista, että tiiviste kiinnittyy oikein uralliselle alueelle.
- 4 Laske teräyksikkö varovasti teränpitimeen ja kiinnitä se napsauttamalla paikalleen.
- 5 Pidä kiinni kootusta teränpitimestä alapuolelta ja laske se kupin päälle niin, että terät osoittavat alaspäin.
- 6 Kierrä koottu teränpidin kupin päälle - lukitse pidin paikalleen kiertämällä sitä myötäpäivään.
- 7 Sekoita ainekset ravistamalla.
- 8 Laske työväline moottoriosan päälle.
- 9 Liitä laitteen virtajohto pistorasiaan. Valitse sykäysnopeus kääntämällä työvälinettä myötäpäivään (kohti kirjainta P) ja irrota työväline. Valitse jatkuva nopeus kääntämällä lisälaitetta myötäpäivään (kohti numeroa 1), kunnes se lukittuu paikalleen.











Juomakansi

- 10 Kiinnitä tiivisterengas juomakanteen. Varmista, että tiiviste kiinnittyy oikein uralliselle alueelle.
- 11 Kun haluat käyttää juomakantta, kierrä koottu teränpidin irti kupista. Kiinnitä juomakansi myötöpäivään kiertämällä.
- 12 Kun haluat juoda, käännet vain kannen suojuksen auki. Juoma voidaan juoda suoraan pullosta.
- 13 Kun olet juonut, laita kannen suojus takaisin paikalleen. Kiinnitä suojus painamalla sitä lujasti.

Vihjeitä ja neuvoja

- Huomaa, että kun sekoituskannu on täytetty maksimitilavuuteensa (600 ml), tämä tarkoittaa noin kahta annosta.
- Jos et aio nauttia juomaa välittömästi, pidä se kylmänä ja nauti se 24 tunnin kuluessa.
- Varmista, että juoma on riittävän ohutta juotavaksi annostelukannen avulla. Saat ohuempaa juomaa lisäämällä nestettä.
- Kaikista juomista ei tule täysin tasaisia sekoituksen jälkeen, jos niissä on siemeniä tai kuituisia aineksia.
- Joidenkin juomien ainekset voivat erottua juoman seistessä, joten juoma on parasta juoda heti. Erottunut juoma on sekoitettava ennen nauttimista.
- Pidä kuppi pystysuorassa aina silloin, kun juomakansi on kiinnitettynä.

Käyttökaavio

L		 MAX (g)		 (Sec)
	 3 cm	600 ml	1	30-60
		100 g	10-20	P
		X 6 120-140 g	P	10-20
		50 g	P	10-20
		100 g	1	30-60
		50 g	P	10

Reseptit

Pesto

60 g tuoretta basilikaa

1 valkosipulin kynsi

25 g pinjansiemeniä

25 g raastettua parmesanjuustoa

110 g oliiviöljyä

Suolaa - maun mukaan

Pippuria - maun mukaan

- 1 Aseta kaikki ainekset sekoittimen/leikkurin sekoituskannuun. Käytä sykäysnopeutta 5 kertaa ja jatka sen jälkeen käsittelyä, kunnes haluttu koostumus on saavutettu (noin 25 sekuntia).

Luumumarinadi

300 g hunajaa

40 g luumuja

70 ml vettä

- 1 Aseta kaikki ainekset sekoittimen/leikkurin sekoituskannuun. Jätä jääkaappiin yön yli. (Älä säilytä aineksia kupissa yli 24 tunnin ajan).
- 2 Käsittele 4 sekunnin ajan sykäysnopeudella. Nauti välittömästi.

Johdon säätö

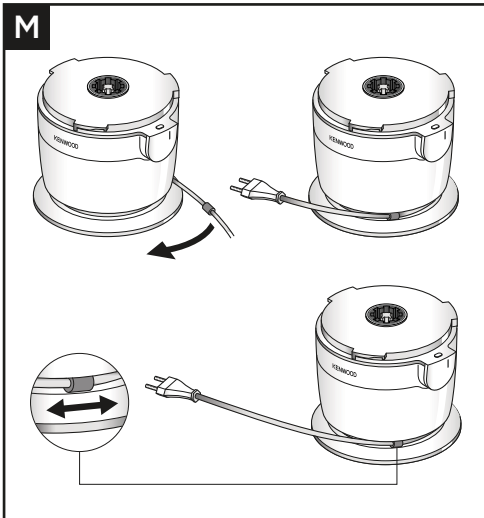

- Kiedo johto sopivan pituiseksi yleiskoneen alaosan ympärille ja kiinnitä johto nippuun pidikkeellä.

Säilytys

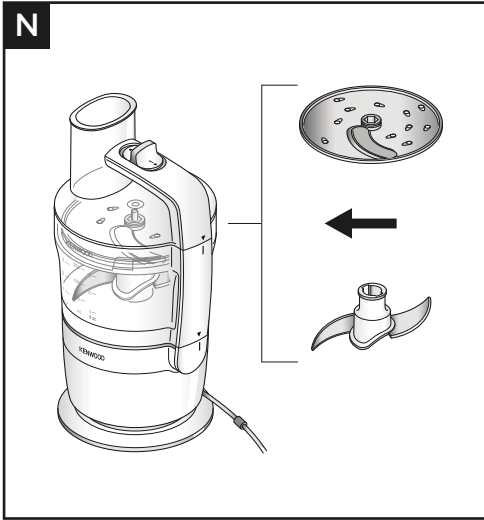

- Veitsiterä ja yksi levy voidaan säilyttää käytön jälkeen kulhossa yhdessä.
- Toinen levy (jos sellainen sisältyy toimitukseen) voidaan säilyttää Express Serve -lisälaitteen kulhossa.
- Älä käytä keittiökoneita niin, että sekä veitsiterä että levy ovat kiinnitettyinä. Käytä ainoastaan yhtä työvälinettä kerrallaan.

Huolto ja asiakaspalvelu

- Jos laitteen käyttämisen aikana ilmenee ongelmia, katso lisätietoja käyttöohjeen ongelmanratkaisuohteista tai siirry osoitteeseen www.kenwoodworld.com ennen avun pyytämistä.
- Tuotteesi takuu koostuu sen varsinaisesta takuusta ja ostomaan kuluttajansuojasta.
- Jos Kenwood-tuotteesi vikaantuu tai siihen tulee toimintahäiriö, toimita tai lähetä se valtuutettuun KENWOOD-huoltokorjaamoon. Löydät lähimmän valtuutetun KENWOOD-huoltokorjaamon tiedot osoitteesta www.kenwoodworld.com tai maakohtaisesta sivustosta.
- Kenwood on suunniteltu ja muotoiltu Isossa-Britanniassa
- Valmistettu Kiinassa.



TÄRKEITÄ TIETOJA TUOTTEEN HÄVITTÄMISEKSI OIKEIN SÄHKÖ- JA ELEKTRONIIKKALAITEROMUSTA ANNETUN ASETUKSEN (WEEE) MUKAISESTI

Tuotetta ei saa hävittää yhdessä tavallisten kotitalousjätteiden kanssa sen lopullisen käytöstä poiston yhteydessä.

Vie se paikallisten viranomaisten hyväksymään kierrätyskeskukseen tai anna se jälleenmyyjän hävitettäväksi, mikäli kyseinen palvelu kuuluu jälleenmyyjän toimialaan.

Ongelmanratkaisuhjeita

Ongelma	Syy	Ratkaisu
Yleiskone ei toimi.	Ei virtaa.	Tarkista, että yleiskoneen virtajohto on pistorasiassa.
	Kulhoa ei ole kiinnitetty moottoriyksikköön kunnolla.	Yleiskone ei toimi, jos kulhoa tai kantta ei ole lukittu oikein paikoilleen.
	Kulhon kansi ei ole kunnolla paikoillaan.	Tarkista, että kulho ja kansi on kohdistettu oikein toisiinsa ja että ne ovat lukkiutuneet oikein.
Yleiskone pysähtyy kesken kaiken.	Yleiskone on ylikuormitettu tai suurin kapasiteetti on ylitetty.	Tarkista suurimmat kapasiteetit käyttösuositustaulukosta.
	Kansi on auki.	Tarkista, että kansi on lukkiutunut oikein.
Kulhoa ei voi kiinnittää alaosaan, kun kansi on kiinnitettyinä.	Virtakytkin on "On (Päällä)"-asennossa.	Siirrä kytkin asentoon "Off" (Pois päältä).
Aineksia ei tule ulos Express Serve -toiminnon poistoaukosta.	Nestelinkolevyä ei ole kiinnitetty raastin/siivutusterän alle.	Kiinnitä nestelinkolevyä.
Viipalointiterä vahingoittaa viipaloituja tai raastettuja aineksia.	Käyttö sekä viipalointiterä että raastinterä kiinnitettyinä kuilhoon.	Poista viipalointiterä ennen raastinterän/siivutusterän käyttöä.
Yksikkö epävakaava/voimakas värinä ja liike.	Taikinaa käsitellään liian kauan. Yleiskone on ylikuormitettu tai suurin kapasiteetti on ylitetty.	Tue laitetta kannen kahvasta, jos laite alkaa liikkua työtasolla. Älä käsittele taikinaa 30 minuuttia kauemmin äläkä ylitä käyttökaaviossa suositeltua enimmäismäärää.
	Taikinan uudelleenvaivaus.	Vaivaa taikina uudelleen ainoastaan käsin. Uudelleenvaivausta kulhossa ei suositella, koska se voi tehdä yleiskoneesta epävakaan.
	Käsitellään tahmeita ainesosia kuten taateleita.	Parhaat tulokset saat, kun käytät ensin Sykäys-toimintoa hajottamaan ainekset ja käytät sen jälkeen jatkuvaa toimintoa.
Syöttöputkesta roiskuu tai syöksyy ulos paljon aineksia.	Syöttöpainin ei ole kiinnitettyinä.	Kiinnitä aina syöttöpainin, kun käsittelet taikinaa, leivonnaisia ja leivoksia, jotta ainekset eivät roisku ulos syöttöputkesta.
Viipalointiterä ja raastinterä toimivat huonosti.	Katso osiota Vinkkejä ja vihjeitä ja noudata käyttökaavion suosituksia.	

Ongelmanratkaisuohteita

Ongelma	Syy	Ratkaisu
Henkilökohtainen sekoitin/leikkuri ei toimi.	Henkilökohtaista sekoitinta/leikkuria ei ole lukittu oikein. Henkilökohtaisen sekoittimen/leikkurin pohjaosaa ei ole lukittu oikein.	Henkilökohtainen sekoitin/leikkuri ei toimi, jos se on kiinnitetty väärin lukitusosaan.
Henkilökohtainen sekoitin/leikkuri vuotaa teräkokonaisuuden pohjasta.	Tiiviste puuttuu. Tiiviste ei ole oikein paikallaan. Tiiviste on vaurioitunut. Teränpidin ei ole täysin/oikein kiristetty.	Tarkista, että teränpidin on kierretty täysin paikalleen. Tarkista, että tiiviste on asennettu oikein uraan kaavion J3 mukaisesti ja että se ei ole vaurioitunut. Varaosien hankkimisesta on lisätietoja Huolto ja asiakaspalvelu -kohdassa.
Henkilökohtainen sekoitin/leikkuri vuotaa juomakannesta.	Kansi lukitsematta.	Tarkista, että kansi on kunnolla paikoillaan.

Türkçe

- Önemli Güvenlik Bilgileri 288-290
- Fişe takmadan önce 290
- Bakım ve temizlik 291-292
- Parça Listesi 293-294
- Mutfak Robotunuzun Kullanımı - Bıçak 295-298
 - Kullanım Şemaları ve Kullanım Talimatları 295-296
 - Kullanım Tablosu 297
 - Tarif 298
- Mutfak Robotunuzun Kullanımı - Diskler 298-299
 - Kullanım Şemaları ve Kullanım Talimatları 298-299
 - Kullanım Tablosu 299
- Express Serve Aparatınızı Kullanmak İçin 300-301
 - Kullanım Şemaları ve Kullanım Talimatları 300
 - Kullanım Tablosu 301
- Kişisel Blender/ Doğrayıcınızı Kullanmak İçin 302-306
 - Kullanım Şemaları ve Kullanım Talimatları 302-304
 - Kullanım Tablosu 305
 - Tarifler 306
- Kablo Ayarlama 306
- Depolama 307
- Servis ve Müşteri Hizmetleri 308
- Sorun giderme kılavuzu 309-310

Önemli Güvenlik Bilgileri



- Bu talimatları dikkatle okuyun ve gelecekteki kullanımlar için saklayın.
- İlk kez kullanmadan önce tüm ambalajları, pazarlama literatürlerini ve plastik bıçak kapaklarını çıkarın. Parçaları yıkayın: bkz. 'Bakım ve temizlik'.
- Fiş veya kablo hasar görürse, güvenlik nedeniyle, tehlikeye yol açmaması için Kenwood ya da yetkili bir Kenwood tamircisi tarafından değiştirilmelidir.
- **Keskin bıçaklara DOKUNMAYIN.** Bıçaklar ve diskler çok keskindir, dikkatli kullanın. **Keskin bıçakları tutarken, kaseyi boşaltırken ve temizleme sırasında kesici kenardan uzak durarak tepesinden parmak uçlarınızla tutun.**
- **Mutfak robotu haznesi ve ekspres servis, buz küplerini işlemek için uygun değildir.**
- Cihazı kapaktaki tutamakla kaldırmadan veya taşımadan önce, daima kaseyi ve kapağın güvenli şekilde yerlerine kilitlemiş olduğundan emin olun.
- Kişisel blender dahil olmak üzere, sağlanan kapların hiçbirinde sıcak malzemeleri **işlemeyin.** Ani buharlaşma nedeniyle sıcak sıvılar cihazdan dışarı sıçrayabilir.
- Çalışırken cihazın başından **asla** ayrılmayın.
- Çalıştırma esnasında cihazı **hareket ettirmeyin.**
- Önerilen kullanım tablosunda belirtilen maksimum **kapasiteleri aşmayın.**
- **Hamur işlerken 5 dakikalık bir dinlenme süresi olmadan cihazınızı 30 saniyeden daha uzun süre çalıştırmayın. Daha uzun süreler boyunca sürekli işlem yapmak cihazınıza zarar verebilir.**
- İçeriği mutfak robotu kasesinden boşaltmadan önce **daima** bıçağı ve diskleri çıkarın.
- Ellerinizi ve mutfak aletlerini, güç kaynağına bağlıyken mutfak robotu kasesinden uzak tutun.
- Yiyeceklerin mutfak robotu kasesinde aşağı itilmesi gerekiyorsa, spatula gibi uygun bir alet kullanın.
- Yiyecekleri **asla** parmaklarınızla gıda girişinden aşağı itmeyin. Her zaman sağlanan iticiyi kullanın.
- Başboş bırakıldıysa ve monte, demonte edilmeden veya temizlemeden önce **daima** cihazı kapatın ve fişini prizden çekin.
- **DİKKAT:** Kaseyi kapağını açmadan önce, ekler/bıçaklar tamamen durana kadar bekleyin.
- Yiyecekleri içeri itmek için **asla** aşırı güç uygulamayın – cihaza zarar verebilirsiniz.
- Robotu çalıştırmak için kapak kilidini kullanmayın, **daima** açma/kapatma hız kontrolünü kullanın.
- Robotu hem bıçak hem de disk takılıyken **çalıştırmayın.** Her seferinde sadece bir ek kullanın.
- **Kilitleme mekanizması aşırı yüke maruz kaldığında cihaz hasar görecektir ve yaralanmaya neden olabilecektir.**
- Asla onaylanmamış parçalar kullanmayın.
- Asla hasarlı bir cihaz kullanmayın. Kontrol veya tamir ettirin: bkz. 'Servis ve müşteri hizmetleri'.

- Cihazın motor kısmı, elektrik kablosu ya da elektrik fişinin ıslanmasına **izin vermeyin**.
- Elektrik kablosunun masa/tezgah kenarlarından sarkmasını ya da sıcak yüzeylere temas etmesine **izin vermeyin**.
- Çocuklar cihazla oynamaları gerektiği konusunda bilgilendirilmelidir.
- Bu cihaz çocuklar tarafından kullanılmalıdır. Cihazı ve kordonunu çocukların erişemeyeceği yerde tutun.
- Bu cihaz, fiziki, algılama ya da zihinsel kapasiteleri yetersiz kişiler tarafından ya da yeterli deneyimi olmayan kişilerce gözetim altında olmaları ve cihazın güvenli şekilde kullanımına ilişkin talimatları almaları ve olası tehlikeleri anlamaları şartıyla kullanılabilir.
- Bu cihazı sadece iç mekanlarda kullanım alanının olduğu yerlerde kullanın. Kenwood, cihaz uygunsuz kullanımlara maruz kaldığı ya da bu talimatlara uyulmadığı takdirde hiçbir sorumluluk kabul etmez.
- Cihazınızın yanlış kullanımı yaralanmalara neden olabilir.

Express Serve

- Hareketli parçalarla temastan kaçının. Parmaklarınızı yiyecek çıkış ağzından uzak tutun.
- Tutucu plaka olmadan **çalıştırmayın. Tutucu plaka takılı değilken, yiyecekler plakanın altına sıkışacak ve çıkıştan çıkmayacaktır bunun sonucunda eklentiniz hasar görecektir.**
- Yiyecekler, yiyecek çıkışından çıkmıyorsa, aleti kapatın ve yiyeceğin diskin altında birikmediğinden ve serpm plakasının tam oturduğundan emin olun. İşlemeye devam etmeden önce birikmiş yiyecekleri temizleyin.
- **Express Servis eklentisini 2 dakikadan daha uzun süre sürekli çalıştırmayın. Her 2 dakikalık çalışmadan sonra 2 dakika soğumaya bırakın.**

Kişisel Blender/ Doğrayıcı Güvenliği

-  Sıcak malzemeleri **İŞLEMİYİN**.
-  Karbonatlı sıvıları **KARIŞTIRMAYIN**.
- **HAŞLANMA RİSKİ:** Sıcak malzemeler kaba yerleştirilmeden veya karıştırılmadan önce oda sıcaklığına kadar soğumaya bırakılmalıdır.
- Malzemeleri 24 saatten uzun süre kapta muhafaza etmeyin.
- Bıçak tertibatını tutarken **her zaman** dikkat edin ve temizlerken bıçakların keskin kenarlarına dokunmaktan kaçının.
- Blender/doğrayıcıyı **asla** boş çalıştırmayın.
- Smoothie tarifleri - dondurulma sırasında katı bir kütle oluşturan donmuş malzemeleri asla karıştırmayın, kaba eklemeyin önce parçalayın.
- Kabı sadece birlikte verilen bıçak tertibatı ile kullanın.
- **Asla** bardaktan sıcak sıvı içmeyin.
- Kapaktan içerken içeceğin acı olmasına dikkat edin. Özellikle bazı malzemelerin işlenmemiş halde kalabileceği katı ve tam olgunlaşmamış yiyecekleri işlenen istenilen sonucu elde etmek için bazı denemeler gerekebilir.
- Dondurulmuş malzemeleri sıvı olmadan karıştırmayın (buz küpleri hariç).
- **Asla** 3 cm x 3 cm küplerden büyük donmuş meyve veya sebze parçalarını karıştırmayın.

- Kuru malzemeleri (örn. baharatlar, kuruyemişler) **asla** karıştırmayın veya blender/doğrayıcıyı boş çalıştırmayın.
- **Asla** kap takılı olmadan bıçak tertibatını güç ünitesine takmayın.
- Kurutulmuş meyveleri doğramadan önce **daima** çekirdeklerini çıkarın.

Güç Tüketimi

- Cihaz çalışır durumda değilken
 - KAPALI Moduna otomatik geçiş: Uygulanamaz
 - Kapalı Mod Gücü: $\leq 0,3W$.





Fişe takmadan önce

- | |
|---|
| <ul style="list-style-type: none">● Aygıtı kullanmadan önce evinizdeki elektrik akımının aygıtta belirtilen akımla aynı olduğundan emin olunuz.● Bu cihaz gıda ile temas eden malzemeler ve maddeler ile ilgili EC 1935/2004 Yönetmeliğine uygundur. |
|---|





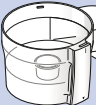





İlk kez Kullanmadan önce

- 1 Plastik bıçak kapağını bıçaktan çıkarın. Dikkat edin bıçaklar çok keskindir. Bu kapak sadece üretim ve nakliye sırasında bıçağı korumak üzere olduğundan atılmalıdır.
- 2 Parçaları yıkayın 'bakım ve temizlik' bölümüne bakın.

Bakım ve temizlik

			
	X	X	✓
	✓	✓	X
	✓	✓	X
	✓	✓	X
	✓	✓	X
	✓	✓	X
	✓	✓	X
	✓	✓	X
	✓	✓	X

Bakım ve temizlik

			
	X	X	✓
	✓	✓	X
	✓	✓	X
	✓	✓	X
	✓	✓	X
	✓	✓	X
	✓	✓	X

- Cihazı kapatın, temizlemeden önce ek parçanın/bıçakların durmasını bekleyin ve fişten çekin.
- Güç ünitesini nemli bir bezle silin, sonra kurulayın. Kilitlenme bölgesinde yiyecek artığı kalmadığından emin olun.
- Güç ünitesini suya sokmayın.
- Bıçakları ve kesme disklerini dikkatli bir şekilde kullanın - son derece keskindirler.
- Kişisel blender/doğrayıcı bıçaklar elde yıkanacaksa, fırçalanarak temizlenmeli ve akan su altında durulanmalıdır.

Parça Listesi

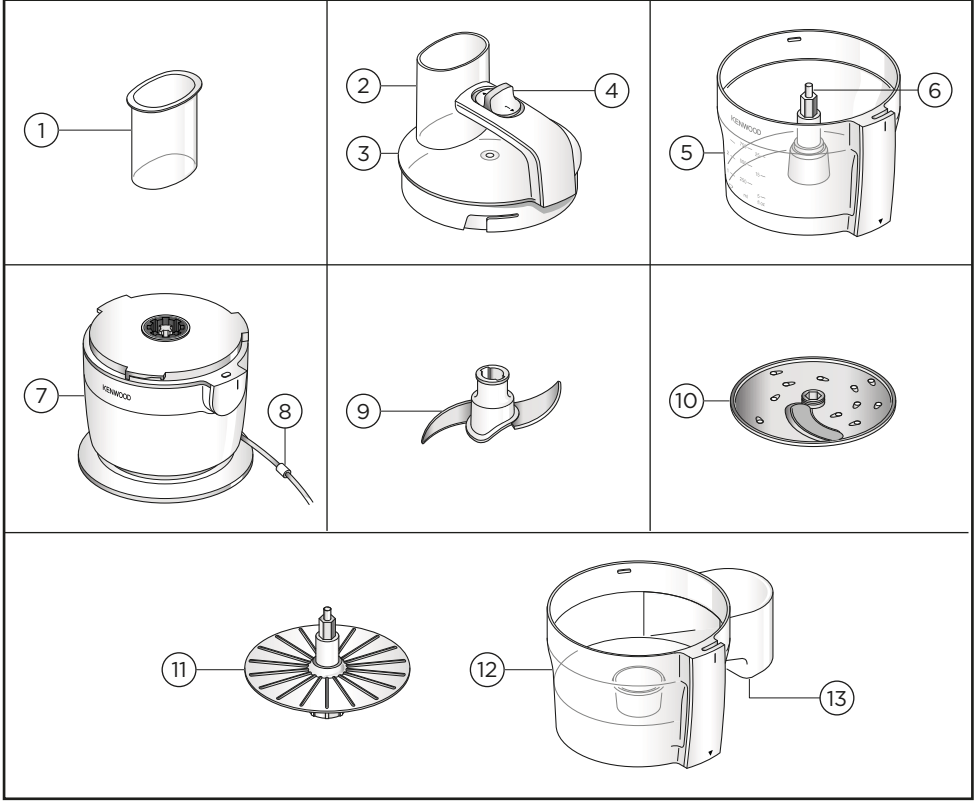

* Ürünle birlikte gelmişse

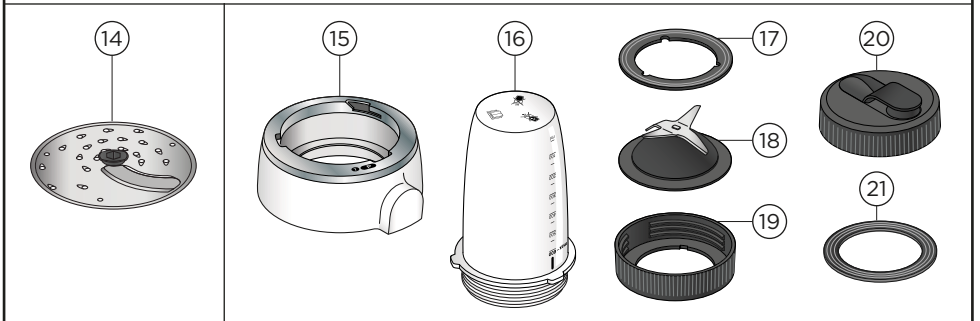

Parçalar

Mutfak robotu

- ① İtçiler
- ② Besleme borusu
- ③ Kapak
- ④ Açma/kapama düğmesi + Puls
- ⑤ Kase
- ⑥ Kase tahriği
- ⑦ Güç birimi
- ⑧ Kablo klipsi
- ⑨ Kesici bıçak
- ⑩ 4 mm Dilimleme/rendeleme diski

Express Serve

- ⑪ Tutucu p laka
- ⑫ Express Servis Kasesi
- ⑬ Yiyecek çıkışı

Diski

- ⑭ 2 mm Dilimleme/rendeleme diski (sağlanmışsa)

Kişisel Blender/Doğrayıcı

- ⑮ Kişisel Blender/ Doğrayıcı Tabanı
- ⑯ Kap
- ⑰ Conta Bileziği
- ⑱ Bıçak Ünitesi
- ⑲ Bıçak Tutucu
- ⑳ Kapak
- ㉑ Kapak Conta Bileziği

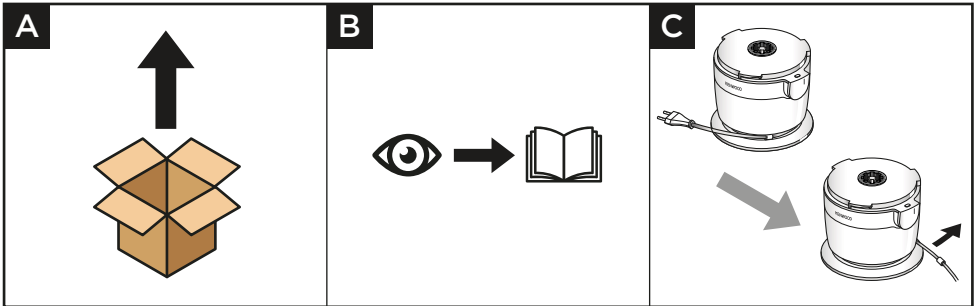

Mutfak Robotunuzun Kullanımı - Bıçak

Kullanım Şemaları ve Kullanım Talimatları

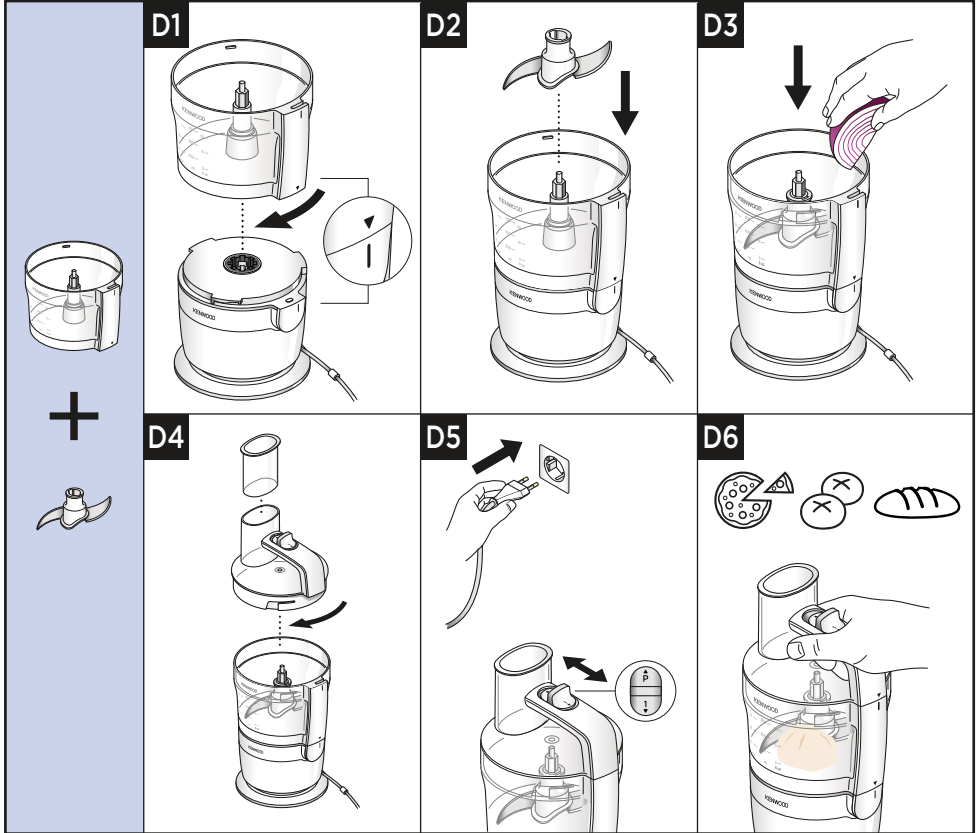

Önemli

































- Mutfak robotunuz kahve çekirdeklerini ve baharatları ezmek veya öğütmek, toz şekeri pudra şekere dönüştürmek veya buz küplerini işlemek için uygun değildir.
- Kase içindeki karışıma badem özü ya da tatlandırıcı eklerken bunların plastik parçalara değmesini önleyin. Aksi halde kalıcı lekeler oluşabilir.
- Her zaman kaseyi ve eki robota malzemeleri eklemeye başlamadan önce yerleştirin.
- Mikseri çalıştırmak için kapağı kullanmayın.
- Kase veya kapak düzgün olarak takılmadığında mutfak robotu çalışmayacaktır. Besleme tüpünün ve kase tutacağına ön sağ köşesine yerleştirilip yerleştirilmediğini kontrol edin.
- Kapağı çıkarmadan önce daima kapatın ve fişten çekin.
- Ekmek hamurunu 30 saniyeden daha uzun süre işlemeyin.
- Ekmek hamurunu yalnızca elle yeniden yoğurun. Kasede tekrar yoğurma yapılması, mutfak robotunun dengesinin bozulmasına neden olabileceği için önerilmez.
- Hamur işlerken üniteyi daima tutacağından tutun.

- 1 Kaseyi güç ünitesine takın ve kilitlemek için saat yönünde çevirin.
- 2 Bıçağı kumanda milinin üzerine yerleştirin.
- 3 Mutfak robotu kasesine malzemeleri ekleyin.
- 4 Kapağı takın.
- 5 Üniteyi şebeke elektriğine takın.
- 6 Üniteyi açın veya puls fonksiyonunu kullanın.

Öneri ve İpuçları

- Kısa aralıklarla darbe (P) kullanın. Puls, kontrol bu pozisyonda tutulduğu sürece çalışacaktır.
- Bazı yiyecekler plastiğin rengini bozabilir. Bu tamamen normaldir ve ne plastiğe ne de yemeğinin lezzetine zarar vermeyecektir. Renk bozulmasını kaldırmak için bitkisel yağa batırılmış bir bezle silin.
- **Ekmek Hamuru** - Kaseye önce kuru malzemeleri koyun sonra sıvıları ekleyin. Pürüzsüz, elastik bir hamur topu oluşana kadar işleyin.
- Cihaz çalışma tezgahı üzerinde hareket ediyorsa destek olmak için kapak üzerindeki tutamağı kullanın.
- Daha kalın doku için darbeleri kontrol kullanın.
- Fazla karıştırmamaya dikkat edin.
- Pasta yaparken buzdolabından çıkarttığınız yağları beklemeden 2cm inç küpler halinde doğrayarak kullanın.

Kullanım Tablosu

E	 Maks. (g)	 (Saniye)
	20-30	10-20
	200	30
	150	20-30
	  2 cm	10/P
	  1/4	P
	  2-3 cm	15-20
	  2 cm	20
	400	60
	x3  + 300 ml 	45-60
	250 g  + 150 g 	30
	250 g 	10-30
	 x3 +  150 g +  150 g +  18-22° C +  150 g	20

Tarif

Kuru Erik Marinatı

400 g Bal

40 g Kuru Erik

50 ml Su

- 1 Bir gece buzdolabında bekletin.
- 2 Puls ayarı ile 4 saniye işleyin

Mutfak Robotunuzun Kullanımı - Diskler

Kullanım Şemaları ve Kullanım Talimatları

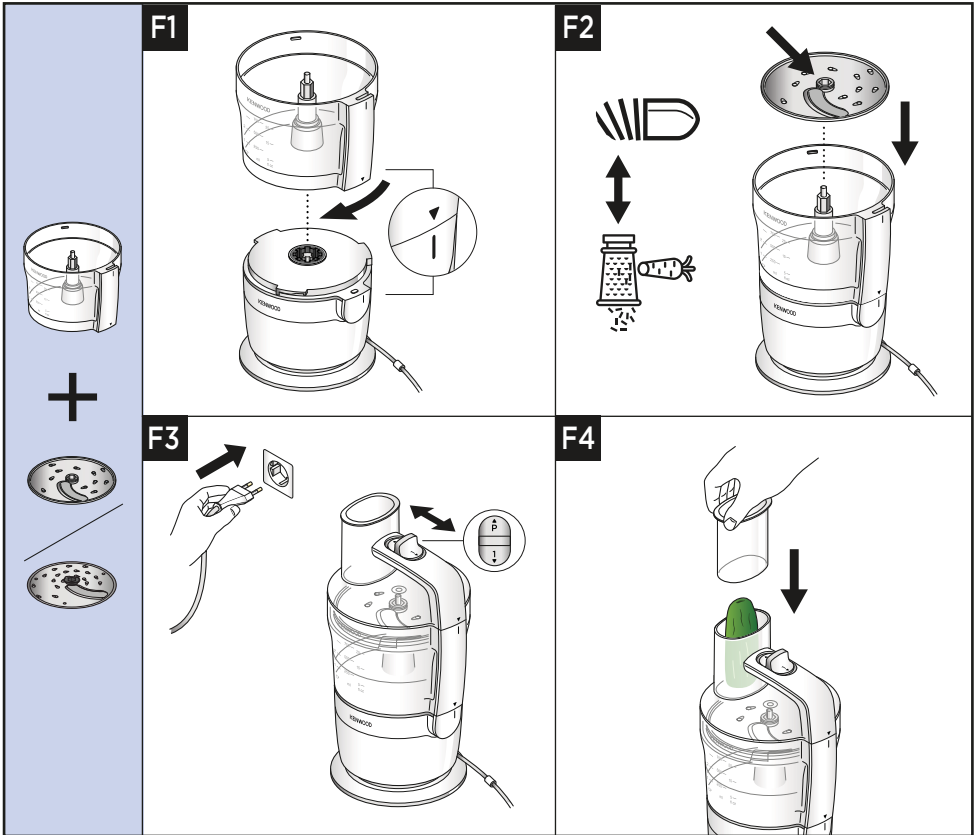

Önemli













- Parmaklarınızı asla besleme haznesinin içine sokmayın.

- 1 Kaseyi güç ünitesine takın ve kilitlemek için saat yönünde çevirin.
- 2 Orta tutamaklardan tutarak, diski uygun yan üstlerle tahrik mili üzerine yerleştirin.
- 3 Kapağı takın.
- 4 Yiyecekleri besleme tüpüne yerleştirin.
- 5 Fişi takın, hız ayarını 1 konumuna getirin ve itici ile eşit şekilde bastırın.

Öneri ve İpuçları

- Taze malzemeler kullanın.
- Yiyecekleri çok küçük kesmeyin. Besleme tüpünün genişliğini malzemelerinizle doldurun (sıkı bir şekilde oturmasından kaçının), bu, işlem sırasında yiyeceklerin yana kaymasını önler.
- Dik yerleştirilen yiyecek yatay yerleştirilen yiyecekten daha kısa çıkar.
- Çalıştırmadan sonra diskin üzerinde ya da çanağın içinde her zaman küçük miktarda artık olacaktır.

Kullanım Tablosu

G 	 Maks. (g)	 (Saniye)
	750 ml 	10-20
	750 ml 	10-20
	 Maks. (g)	 (Saniye)
	750 ml 	10-20

Express Serve Aparatınızı Kullanmak İçin

Kullanım Şemaları ve Kullanım Talimatları

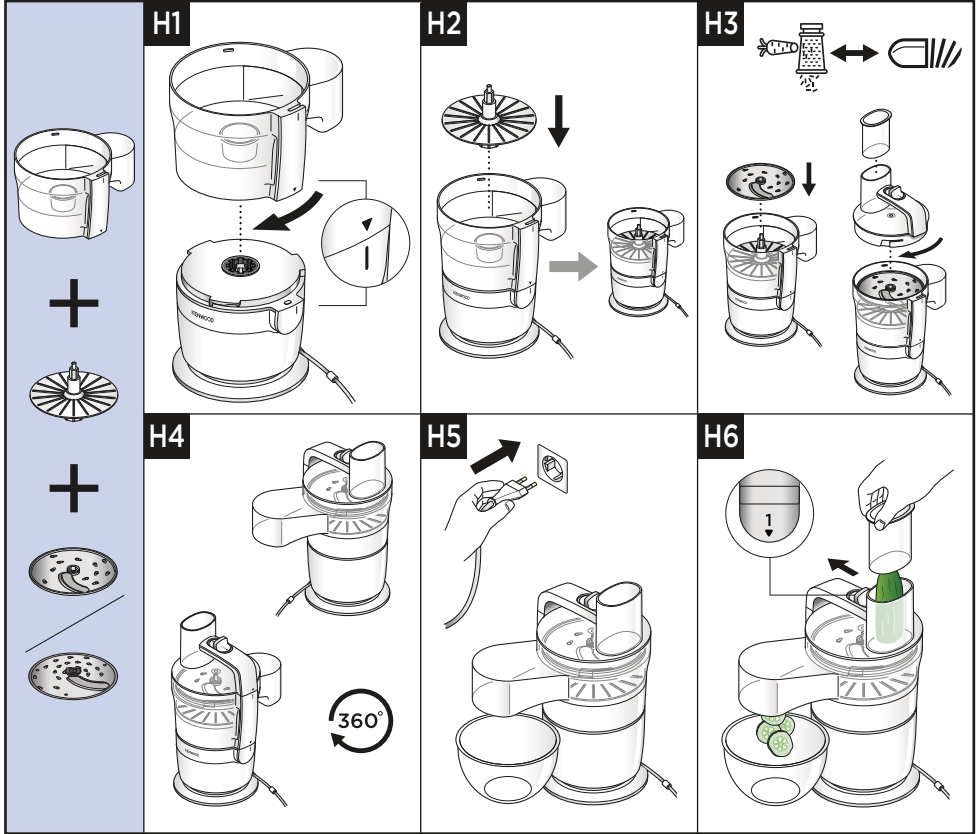











Önemli

- Eki kullanırken aşırı güç uygulamayın.
- Yemek, yemek çıkışından çıkmıyorsa aleti kapatın ve yemeğin diskin altında birikmediğinden ve serpm plakasının tam oturduğundan emin olun. İşleme devam etmeden önce sıkışmış yiyecekleri temizleyin.

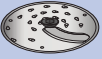
- 1 Kaseyi güç ünitesine takın ve kilitlemek için saat yönünde çevirin.
- 2 Tutucu plakayı ve gerekli diski takın.
- 3 Kapağı takın.
- 4 Yiyecekleri besleme tüpüne yerleştirin.
- 5 Fişi takın, hız ayarını 1 konumuna getirin ve itici ile eşit şekilde bastırın.

Kullanım Tablosu

I 	 Maks. (g)	 (Saniye)
		120
		120
	 Maks. (g)	 (Saniye)
		120

Kişisel Blender/ Doğrayıcınızı Kullanmak İçin

Kullanım Şemaları ve Kullanım Talimatları

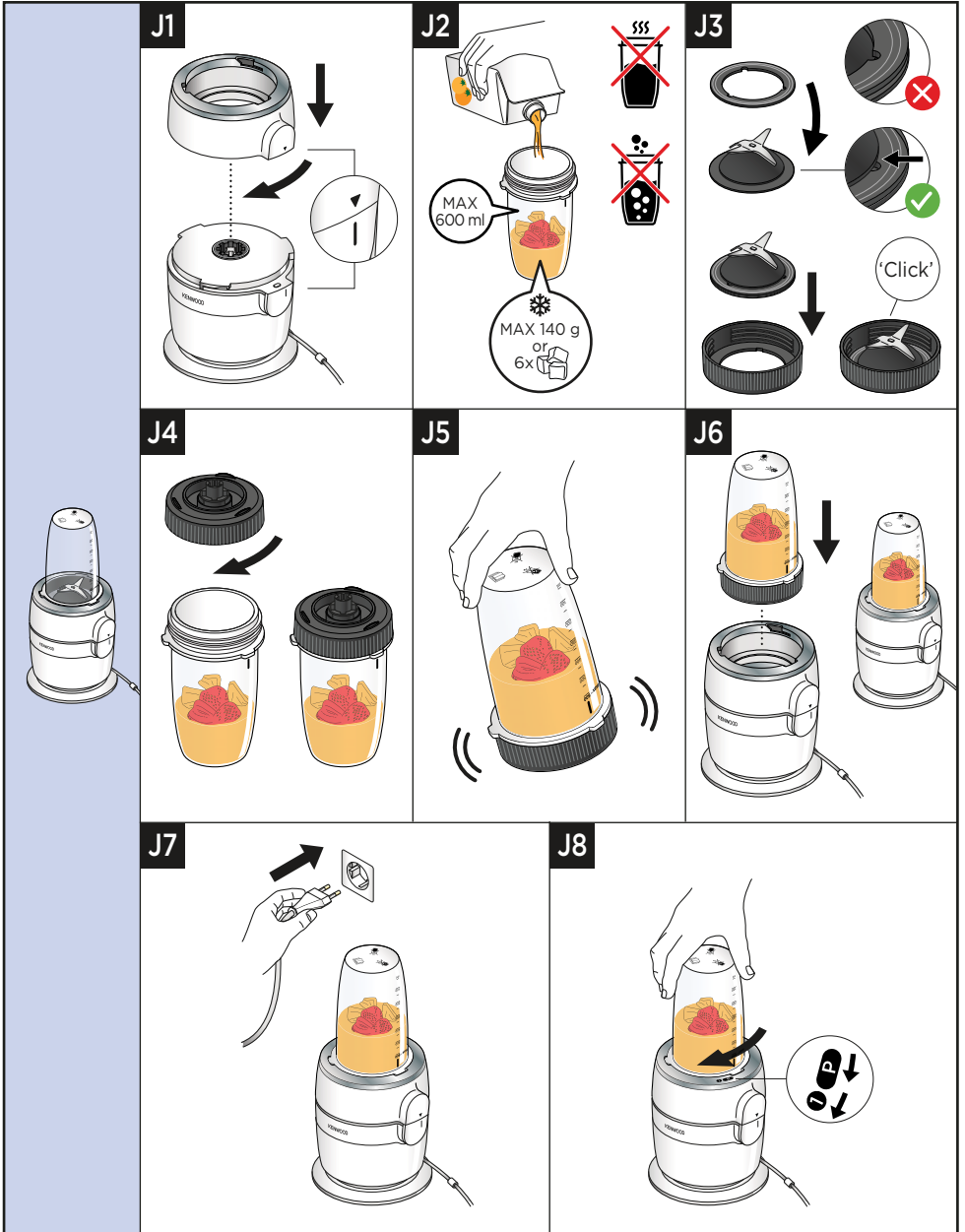

Kişisel Blender/ Doğrayıcınızı Kullanmak İçin

Kullanım Şemaları ve Kullanım Talimatları

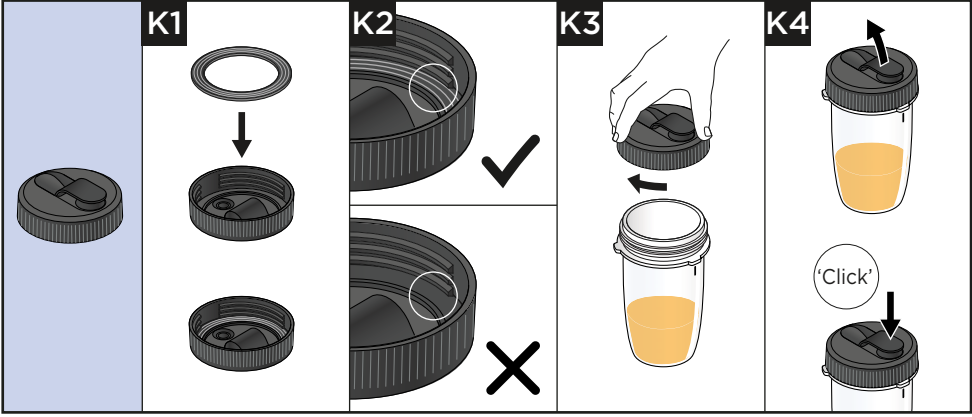

Önemli

- Kişisel blender/doğrayıcı takılmadan önce kişisel blender/doğrayıcı tabanı güç ünitesine takılmalıdır.
- Dondurulmuş malzemeleri sıvı olmadan karıştırmayın (buz küpleri hariç).
- Asla 3 cm x 3 cm küplerden büyük donmuş meyve veya sebze parçalarını karıştırmayın.
- Sızdırmazlık halkasının hasar görmesi veya yanlış takılması durumunda sızıntı meydana gelecektir.
- Katı bir kütle haline gelmiş donmuş malzemeleri asla karıştırmayın.
- En iyi karıştırma performansı için her zaman önce şişeye buz/dondurulmuş malzemeler ekleyin.
- Kurutulmuş meyveleri doğramadan önce **daima** çekirdeklerini çıkarın.

- 1 Kişisel blender/doğrayıcı tabanını güç ünitesine takın, kilitlemek için saat yönünde çevirin.
- 2 Malzemeleri 600 ml seviye işaretine kadar kaba ekleyin.
- 3 Conta bileziğini bıçak ünitesine takın ve contanın yivli alanda doğru şekilde sabitlendiğinden emin olun.
- 4 Bıçak ünitesini dikkatlice bıçak tutucusuna indirin ve sabitlemek için yerine klipsleyin.
- 5 Monte edilmiş bıçak tutucunun alt tarafından tutun ve bıçaklar aşağıda olacak şekilde kabın üzerine indirin.
- 6 Monte edilmiş bıçak tutucuyu kabın üzerine vidalayın - kilitlemek için saat yönünde çevirin.
- 7 Malzemeleri karıştırmak için sallayın.
- 8 Eki güç ünitesinin üzerine indirin.
- 9 Fişe takın. Puls hızını seçmek için, saat yönünde (P'ye doğru) çevirin ve eklentiyi serbest bırakın. Sürekli hızı seçmek için, eklentiyi yerine kilitlenene kadar saat yönünde (1'e doğru) çevirin.











Kapak

- 10 Conta bileziğini kapağa takın ve contanın yivli alanda doğru şekilde sabitlendiğinden emin olun.
- 11 İçme kapağını kullanmak için, monte edilmiş bıçak tutucuyu bardaktan sökün. İçme kapağını saat yönünde çevirerek takın.
- 12 İçmek istediğinizde kapağı çevirerek açmanız yeterlidir. İçecek doğrudan şişeden tüketilebilir.
- 13 İhtikten sonra kapağı yerine takın. Sabitlemek için sıkıca bastırın.

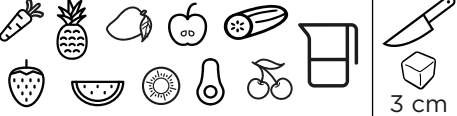
Öneri ve İpuçları

- Kap maksimum kapasiteye (600ml) kadar doldurulduğunda, bunun yaklaşık iki porsiyon ettiğini unutmayın.
- İçeceğinizi hemen tüketmeyi düşünmüyorsanız, buzdolabında muhafaza edin ve 24 saat içinde tüketin.
- İçeceğinizin dağıtım kapağından içilebilecek kadar akışkan olduğundan emin olun. Daha akışkan bir içecek yapmak için daha fazla sıvı ekleyin.
- Karıştırmadan sonra, bazı içecekler çekirdekler veya malzemelerin posası nedeniyle tamamen akışkan olmayabilir.
- Bazı içecekler duruma göre ayrılabilirler, bu nedenle en iyisi onları hemen içmektir. Ayrılan içecekler içilmeden önce karıştırılmalıdır.
- İçme kapağı takıldığında kabı her zaman dik olarak tutun.

Kullanım Tablosu

	 Maks. (g)		 (Saniye)
	600 ml	1	30-60
	100 g	10-20	P
	X 6 120-140 g	P	10-20
	50 g	P	10-20
	100 g	1	30-60
	50 g	P	10

Tarif

Pesto

- 60g Taze Fesleğen
- 1 Diş Sarımsak
- 25g Çam Fıstığı
- 25g Rendelenmiş Parmesan
- 110g Zeytinyağı
- Tuz - zevkinize göre
- Karabiber - zevkinize göre

- 1 Tüm malzemeleri blender/doğrayıcı kabına yerleştirin. Arzu edilen kıvama gelene kadar (yaklaşık 25 saniye) 5 kez karıştırın ve ardından sürekli olarak işlemeye devam edin.

Kuru Erik Turşusu

- 300g Bal
- 40g Kuru Erik
- 70ml Su

- 1 Tüm malzemeleri blender/doğrayıcı kabına yerleştirin. Bir gece boyunca buzdolabında saklayın. (Malzemeleri 24 saatten uzun süre kapta muhafaza etmeyin).
- 2 Pulse hızını kullanarak 4 saniye boyunca işleyin. Derhal kullanın.

Kablo Ayarlama

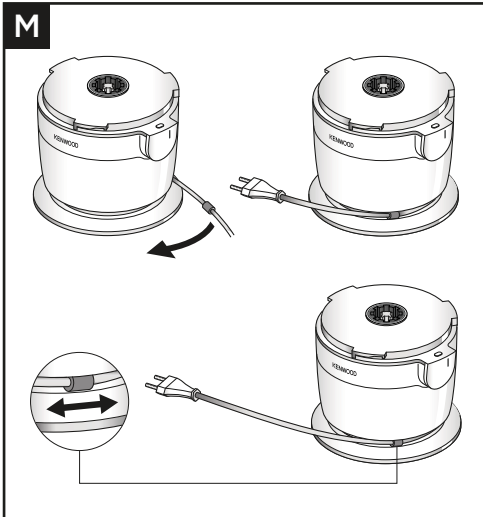

- Kordonu mutfak robotunun tabanının etrafına istediğiniz uzunlukta sarın ve kablo klipsini kullanarak kordonu klipsleyin.

Depolama

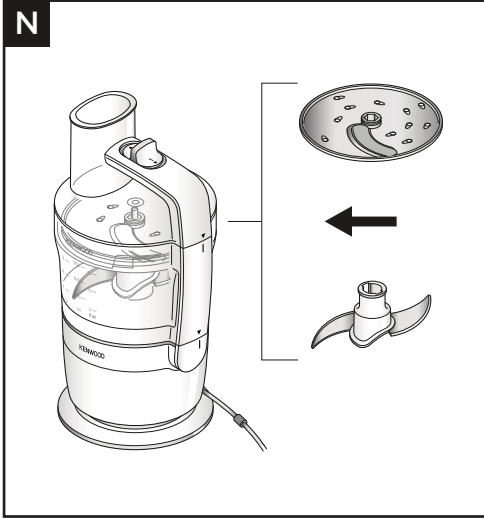

- Kullandıktan sonra, bıçak ve bir disk, birlikte kasede saklanabilir.
- İkinci disk (varsa) hızlı servis kasesinde saklanabilir.
- Robotu hem bıçak hem de bir disk takılıken çalıştırmayın. Her seferinde sadece bir ek kullanın.

Servis ve müşteri hizmetleri

- Cihazınızın çalışması ile ilgili herhangi bir sorun yaşarsanız, yardım istemeden önce bu kılavuzdaki "Sorun giderme kılavuzu" bölümüne bakın veya www.kenwoodworld.com adresini ziyaret edin.
- Lütfen unutmayın, ürün ürünün satıldığı ülkedeki mevcut tüm garanti ve tüketici hakları ile ilgili yasal mevzuata uygun bir garanti kapsamındadır.
- Kenwood ürününüz arızalanırsa veya herhangi bir kusur bulursanız yetkili KENWOOD Servis Merkezine gönderin veya götürün. Size en yakın yetkili KENWOOD Servis Merkezinin güncel bilgilerine ulaşmak için www.kenwoodworld.com adresini veya ülkenize özel web sitesini ziyaret edin.
- Kenwood tarafından İngiltere'de dizayn edilmiş ve geliştirilmiştir.
- Çin'de üretilmiştir.



ÜRÜNÜN ATIK ELEKTRİKLİ VE ELEKTRONİK EKİPMANIN BERTARAF EDİLMESİNE İLİŞKİN AVRUPA DİREKTİFİNE UYGUN ŞEKİLDE BERTARAF EDİLMESİ HAKKINDA ÖNEMLİ BİLGİ (WEEE)

Kullanım ömrünün sonunda ürün evsel atıklarla birlikte atılmamalıdır.

Ürün yerel yetkililerce belirlenmiş atık toplama merkezine veya bu hizmeti sağlayan bir satıcıya götürülmelidir.

Sorun giderme kılavuzu

Sorun	Neden	Çözüm
Mutfak robotu çalışmıyor.	Elektrik akımı yok.	Fişin prize takılı olup olmadığını kontrol ediniz.
	Kase güç ünitesine doğru yerleştirilmemiş.	Kase veya kapak düzgün olarak takılmadığında mutfak robotu çalışmayacaktır.
	Kase kapağı doğru kilitlenmemiştir.	Kase ve kapağın hizalandığından ve doğru şekilde kilitlendiğinden emin olun.
Robot çalışma sırasında duruyor.	Robot aşırı yüklenmiştir/ maksimum kapasitesini aşmıştır.	“Önerilen Kullanım Grafiği’ndeki” maksimum kapasiteleri kontrol edin.
	Kapağın kilidi açıldı.	Kapağın doğru kilitlenip kilitlenmediğini kontrol edin.
Kapak takılı iken kase tabana takılmıyor.	Açma/kapama düğmesi ‘Açık’ konumda.	Anahtarı ‘kapalı’ konuma getirin.
Ekspres servis çıkışından yiyecek çıkmıyor.	Tutucu plaka rendeleme/ dilimleme diskinin altına takılmamış.	Tutucu plakayı takın.
Bıçak, dilimlenmiş veya rendelenmiş yiyeceklere zarar veriyor.	Hem bıçak hem de disk kaseye takılı halde çalıştırma.	Rendeleme/dilimleme diskini takmadan önce bıçağı çıkartın.
Cihaz dengesiz/ağır titreşimler ve hareket.	Hamuru çok uzun süre işleme.	Cihaz çalışma tezgahı üzerinde hareket ediyorsa destek olmak için kapak üzerindeki tutamağı kullanın. Hamuru 30 saniyeden daha uzun süre işlemeyin ve kullanım tablosunda önerilen maksimum miktarı aşmayın.
	Robot aşırı yüklenmiştir/ maksimum kapasitesini aşmıştır.	Tekrar yoğurmayı sadece elle yapın. Mutfak robotunu dengesizleştirebileceğinden kasede tekrar yoğurma yapılması önerilmez.
	Hamuru tekrar yoğurma.	En iyi sonucu elde etmek için, önce malzemeleri parçalamak amacıyla ‘Puls’ modunu kullanın, sonra sürekli çalıştırmaya geçin.
Yoğun sıçrama veya malzemeler besleme tüpünden dışarı çıkıyor.	İtici takılı değil.	Besleme tüpünden dışarı sıçrama olmasını önlemek için, hamur, hamur işleri ve kekleri işlerken iticiyi daima takın.
Bıçak ve disk düzgün çalışmıyor.	Tavsiyeler ve ipuçları bölümüne bakın ve kullanım tablosundaki önerilere uyun.	

Sorun giderme kılavuzu

Sorun	Neden	Çözüm
Kişisel Blender/Doğrayıcı çalışmıyor.	Kişisel Blender/Doğrayıcı doğru şekilde kilitlenmiyor Kişisel Blender/ Doğrayıcı Tabanı doğru şekilde kilitlenmiyor	Kişisel Blender/Doğrayıcı, güvenlik kilidine yanlış takılırsa çalışmayacaktır.
Kişisel Blender/Doğrayıcı bıçak ünitesi tabanından sızıntı yapıyor.	Sızdırmaz halka yerinde değil. Sızdırmaz halka yerine doğru takılı değil. Sızdırmaz halka hasarlı. Bıçak tutucu tam olarak/ düzgün bir şekilde sıkılmamış.	Bıçak tutucusunun tamamen sıkıldığını kontrol edin. Contanın J3 şemasına göre oluğa doğru şekilde takıldığını ve hasar görmediğini kontrol edin. Hasarlı Sızdırmazlığın yedeğini elde etmek için "Servis ve müşteri hizmetleri"ne bakın.
Kişisel Blender/Doğrayıcı içme kapağından sızıntı yapıyor.	Kapak açılmış.	Kapağın doğru kilitlenip kilitlenmediğini kontrol edin.

Kenwood Ltd

New Lane
Havant
Hampshire
PO9 2NH

kenwoodworld.com

© Copyright 2025 Kenwood Limited. All rights reserved



5722077050/2