



# APPLIANCES FOR LIVING

 **ARTUSI**  
THE ART OF LIVING

**ADW7003 X/W**  
**OPERATION MANUAL**

Congratulations, you are now the proud owner of an ARTUSI cooking appliance. Thank you for purchasing ARTUSI and welcome to the ARTUSI Family.

This instruction manual has been specially created to inform you of the full range of features your ARTUSI appliance has to offer and serves as an introduction to getting the very best out of your ARTUSI appliance.

We present detailed information on each of the features your ARTUSI appliance consists of. Once you have read this section you will be able to choose the most appropriate settings for your appliance when cooking different types of food.

We ask you to read the instructions in this booklet very carefully as this will allow you to get the best results from using your appliance. KEEP THE DOCUMENTATION OF THIS PRODUCT FOR FUTURE REFERENCE.

TO REGISTER YOUR PRODUCT WITH ARTUSI, PLEASE FILL OUT THE WARRANTY CARD AT THE END OF THIS BOOKLET AND POST IT TO: **REPLY PAID 83617**  
**LEICHHARDT NSW 2040**

Dear Artusi Customer, please read this user manual carefully before using the product and, keep it permanently at your disposal.

Note: This user manual is prepared for more than one model. Some of the features specified in this Manual may not be available on your appliance.

All our appliances are only for domestic use, not for commercial use. Products marked with (\*) are optional.





“THIS APPLIANCE SHALL BE INSTALLED IN ACCORDANCE WITH THE REGULATIONS FORCE AND ONLY USED IN A WELL VENTILATED SPACE. READ THE INSTRUCTIONS BEFORE INSTALLING OR USING THIS APPLIANCE”

“Conforms with the WEEE Regulations.”

## Thank you for choosing this product.

This User Manual contains important information on safety and instructions intended to assist you in the operation and maintenance of your appliance.

Please take the time to read this User Manual before using your appliance and keep this book for future reference.

Icon	Type	Meaning
	<b>WARNING</b>	Serious injury or death risk
	<b>RISK OF ELECTRIC SHOCK</b>	Dangerous voltage risk
	<b>SYMBOL ISO 7010 W021</b>	
	<b>CAUTION</b>	Injury or property damage risk
	<b>IMPORTANT / NOTE</b>	Operating the system correctly

# CONTENTS

<b>1.SAFETY INSTRUCTIONS</b> .....	<b>1</b>
1.1. General Safety Warnings .....	1
1.2. Installation Warnings .....	1
1.3. During Use.....	2
<b>2.INSTALLATION</b> .....	<b>6</b>
2.1. Machine Positioning .....	6
2.2. Water Connection .....	6
2.3. Water Inlet Hose.....	6
2.4. Drain Hose.....	6
2.5. Electrical Connection .....	7
2.6. Fitting the Machine Undercounter .....	7
<b>3.TECHNICAL SPECIFICATIONS</b> .....	<b>8</b>
3.1. General Appearance.....	8
3.2. Technical Specifications .....	8
<b>4.BEFORE USING THE APPLIANCE</b> .....	<b>9</b>
4.1. Detergent Usege .....	9
4.2. Filling the Detergent .....	9
4.3. Using Combined Detergents .....	9
4.4. Rinse-aid Usege .....	9
4.5. Filling the Rinse-aid and Setting .....	9
<b>5.LOADING YOUR DISHWASHER</b> .....	<b>9</b>
5.1. Recommendations.....	12
5.2. Alternative Basket Loads .....	13
<b>6.PROGRAMME TABLE</b> .....	<b>14</b>
<b>7.THE CONTROL PANEL</b> .....	<b>15</b>
7.1. Changing a Programme .....	16
7.2. Cancelling a Programme .....	16
7.3. Switching the Machine Off .....	16
<b>8.CLEANING AND MAINTENANCE</b> .....	<b>17</b>
8.1. Cleaning the Machine and Filters .....	17
8.2. Spray Arms.....	17
<b>9.TROUBLESHOOTING</b> .....	<b>18</b>
<b>10.PRACTICAL INFORMATION</b> .....	<b>20</b>

# 1. SAFETY INSTRUCTIONS

## 1.1. General Safety Warnings

- Read these instructions carefully before using your appliance and keep this manual for future reference.

 Please check the packaging of your machine before installation and the outer surface of the machine once the packaging has been removed. Do not operate the machine if it appears damaged or if the packaging has been opened.

- Packaging materials protect your machine from any damage that might occur during transportation. The packaging materials are environmentally friendly as they are recyclable. Use of recycled material reduces raw material consumption and decreases waste production.

 This appliance can be used by children aged from 8 years and above, and by persons with reduced physical, sensory or mental capabilities or lack of experience and knowledge if they have been given supervision or instruction concerning the use of the appliance in a safe way and understand hazards involved. Children should not be allowed to play with the appliance.

 Remove packaging and keep it out of reach of children.

 Keep children away from detergents and rinse aids.

 There may be some residue left in the machine after washing. Keep children away from the machine when it is open.

## 1.2. Installation Warnings

- Choose a suitable and safe place to install your machine.
- Only original spare parts should be used with the machine.

 Unplug the machine before installation.

 Your machine must only be installed by an authorised service agent. Installation by anyone other than an authorised agent may cause your warranty to be void.

 Check that the indoor electrical fuse system is connected in line with safety regulations.

 All electrical connections must match the values on the plate.

 Ensure the machine does not stand on the electrical supply cable.

 Never use an extension cord or a multiple socket connection.

 The plug should be accessible after the machine is installed.

- After installation, run your machine unloaded for the first time.

 The machine must not be plugged in during positioning.

 Always use the coated plug supplied with your machine.

 If the electrical cable is damaged, it should only be replaced by a qualified electrician.

## 1.3. During Usege

- This machine is for domestic use only; do not use

- it for other purposes. Commercial use will void the guarantee.

 Do not stand, sit or place loads on the open door of the dishwasher.

 Only use detergents and rinse aids produced specifically for dishwashers. Our company is not responsible for any damage that may occur due to misuse.

 Do not drink water from the machine.

 Due to the danger of explosion, do not place any chemical dissolving agents into the machine's washing section.

- Check the heat-resistance of plastic items before washing them in the machine.

 Only put items in the machine which are suitable for dishwashing, and take care not to overfill the baskets.

 Do not open the door while the machine is in operation, hot water may spill out. Safety devices ensure the machine stops if the door is opened.

 The machine door should not be left open. It may cause accidents.

 Place knives and other sharp objects in the cutlery basket in a blade-down position.

 For models with the automatic door-opening system, when the EnergySave option is active, the door will open at the end of a program. To prevent damage to your dishwasher, do not attempt to close the door for one minute after it has opened. For effective drying, keep the door open for 30 minutes after a programme has ended. Do not stand in front of the door after the auto-open signal sounds.

 In the case of a malfunction, repair should only

be performed by an authorised service company, otherwise the warranty will be void.

 Before repair work, the machine should be disconnected from the mains. Do not pull the cable to unplug the machine. Switch off the water tap.

 Operation at a low voltage will cause a decline in performance levels.

 For safety, disconnect the plug once a program has finished.

 To avoid an electric shock, do not unplug the machine with wet hands.

 Pull the plug to disconnect the machine from the mains, never pull on the cord.

## RECYCLING

- Some machine components and packaging consist of recyclable materials.
- Plastics are marked with the international abbreviations: (>PE<, >PP<, etc. )
- The cardboard parts consist of recycled paper. They can be put into waste paper containers for recycling.
- Material unsuitable for domestic waste must be disposed of at recycling centres.
- Contact a relevant recycling centre to obtain information about disposal of different materials.

## PACKAGING AND THE ENVIRONMENT

- Packaging materials protect your machine from damage that may occur during transportation. The packaging materials are environmentally friendly as they are recyclable. The use of recycled material reduces raw material consumption and therefore decreases waste production.

## CE Declaration of Conformity

We declare that our products meet the applicable European Directives, Decisions and Regulations and the requirements listed in the standards referenced.

## Disposal of your old machine



The symbol on the product or on its packaging indicates that this product may not be treated as household waste. Instead, it shall be handed over to the applicable collection point for the recycling of electrical and electronic equipment. By ensuring this product is disposed of correctly, you will help prevent potential negative consequences for the environment and human health, which could otherwise be caused by inappropriate waste handling of this product. For more detailed information about recycling of this product,

please contact your local city office, your household waste disposal service or the shop where the product was purchased.

## 2. INSTALLATION

### 2.1. Machine positioning

When positioning the machine, place it in an area where dishes can be easily loaded and unloaded. Do not put the machine in an area where the ambient temperature falls below 0°C.

Read all warnings located on the packaging before removing the packaging and positioning the machine.

Place the machine close to a water tap and drain. Take into consideration that the connections will not be altered once the machine is in position.

Do not hold the machine by its door or panel.

Leave an adequate distance around the machine to allow ease of movement when cleaning.

 Ensure the water inlet and outlet hoses are not squeezed or trapped and that the machine does not stand on the electrical cable while positioning.

Adjust the feet so the machine is level and balanced. The machine should be placed on flat ground otherwise it will be unstable and the door of the machine will not close properly.

### 2.2. Water connection

We recommend fitting a filter to your water inlet supply in order to prevent damage to your machine due to contamination (sand, rust, etc.) from indoor plumbing. This will also help prevent yellowing and deposit formation after washing.

### 2.3. Water inlet hose





 **WARNING:** Use the new water inlet hose supplied with your machine, do not use an old machine's hose.

 **WARNING:** Run water through the new hose before connecting.

 **WARNING:** Connect the hose directly to the water inlet tap. The pressure supplied by the tap should be a minimum of 0.03 MPa and a maximum of 1 MPa. If the pressure exceeds 1 MPa, a pressure relief valve must be fitted between the connection.

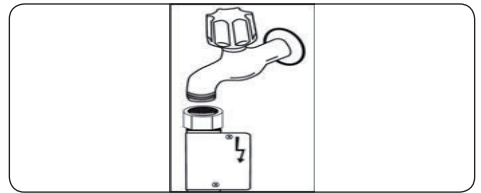
 **WARNING:** After the connections are made, turn the tap on fully and check for water leaks. Always turn off the water inlet tap after a wash program has finished.



 An Aquastop water spout is available with some models. Do not damage it or allow it to become kinked or twisted.

### 2.4. Drain Hose

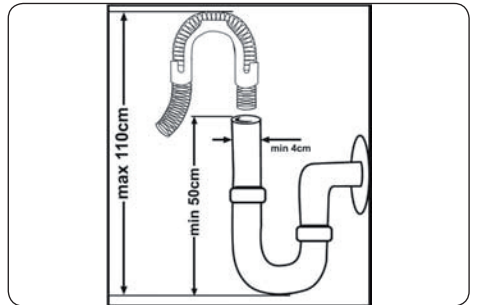

Connect the water drain hose directly to water drain hole or to the sink outlet spigot. This connection should be minimum 50 cm and maximum 110 cm from floor plane.

 **IMPORTANT:** Items will not wash properly if a drain hose longer than 4 m is used.

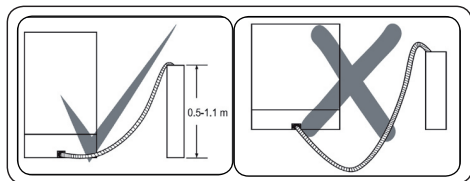

## 2.5. Electrical connection

**! WARNING:** Your machine is set to operate at 220-240 V. If the mains voltage supply to your machine is 110 V, connect a transformer of 110/220 V and 3000 W between the electrical connection.

**! !** The earthed plug of the machine must be connected to an earthed outlet supplied by suitable voltage and current.

**! !** In the absence of earthing installation, an authorised electrician should carry out an earthing installation. In the case of use without earthing installed, we will not be responsible for any loss of use that may occur.

**! The indoor fuse current value should be 10-16 A.**

## 2.6. Fitting the machine undercounter

If you wish to fit your machine undercounter, there must be sufficient space to do so and the wiring-plumbing must be suitable to do so (1). If the space under the countertop is suitable for fitting your machine, remove the worktop as shown in the illustration (2).

**! WARNING:** The countertop, of which the machine will be placed under, must be stable in order to prevent imbalance.

The top panel of the dishwasher must be removed to fit the machine under the countertop.

To remove the top panel, remove the screws that hold it on, located at the rear of the machine. Then, push the panel 1 cm from the front towards the rear and lift it. Adjust the machine feet according to the slope of the floor (3).

Fit your machine by pushing it under the counter taking care not to crush or bend the hoses (4).

**! WARNING:** After removing the top panel of your dishwasher, the machine should be placed in a space of the dimensions shown in the figure below.

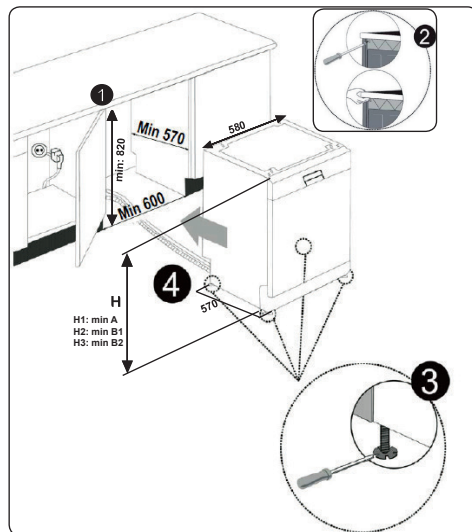

	A	B	
	All Products	B <sub>1</sub>	B <sub>2</sub>
Product's Height (±2 mm)	820 mm	830 mm	835 mm

**A:** If there is no felt on the top of the product; you should take into account this product's height.

**B1:** If there is felt on the top of the product with 2nd basket; you should take into account this product's height.

**B2:** If there is felt on the top of the product with 3rd basket; you should take into account this product's height.

### 3. TECHNICAL SPECIFICATIONS

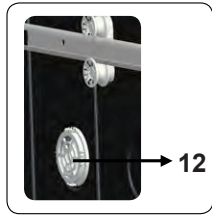
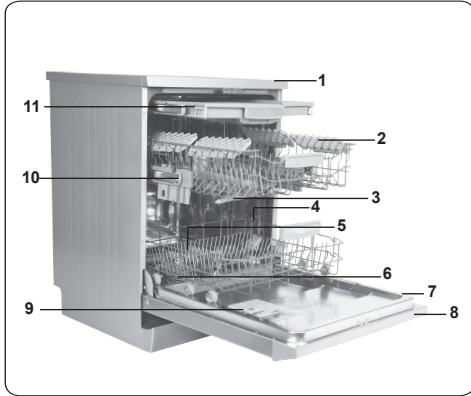

#### 3.1. General appearance

1. Worktop
2. Upper basket with racks
3. Upper spray arm
4. Lower basket
5. Lower spray arm
6. Filters
7. Rating plate
8. Control panel
9. Detergent and rinse-aid dispenser
10. Upper basket track latch
11. Upper Cutlery Basket
12. Turbo Drying Unit: This system provides better drying performance for your dishes.

#### 3.2. Technical specifications

Capacity	15 place settings
Dimensions	
Height	840(mm)
Width	598(mm)
Depth	598(mm)
Net weight	53 kg
Operating voltage / frequency	220-240V 50 Hz,
Total current	10(A)
Total power	1900(W)
Water supply pressure	Maximum: 1 (Mpa) Minimum: 0.03 (Mpa)

## 4. BEFORE USING THE APPLIANCE

### 4.1. Detergent usage

Only use detergents specifically designed for domestic dishwashers.

Add the recommended amount of detergent for the selected programme to ensure the best performance.

Keep your detergents in cool, dry places out of reach of children.

See the detergent manufacturer's instructions for a further information.

### 4.2. Filling the detergent

Push the latch to open the dispenser and pour in the detergent.

Close the lid and press it until it locks in place. The dispenser should be refilled just before the start of each programme. If the dishes are heavily soiled, place additional detergent in the pre-wash detergent chamber.

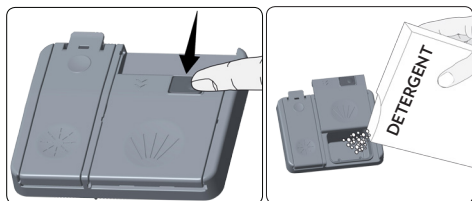

### 4.3. Using combined detergents

These products should be used according to the manufacturer's instructions.

Never put combined detergents into the interior section or the cutlery basket.

Combined detergents contain not only the detergent but also rinse-aid replacement substances and additional components depending on the combination.

We recommend you do not use combined detergents in short programmes. Please use powder detergents in such programmes.

If you encounter problems when using combined detergents, please contact the detergent manufacturer.

When you stop using combined detergents, make sure that rinse aid settings are set to correct level.

### 4.4 . Rinse-aid usage

Rinse-aid makes dishes sparkle and helps them to dry without spotting. Rinse-aid is required for stain-free utensils and clear glasses. Use only rinse-aid for domestic dishwashers.

### 4.5 . Filling the rinse-aid and setting

To fill the rinse aid compartment, open the rinse-aid compartment cap. Fill the compartment with rinse aid to the MAX level and then close the cap. Be careful not to overflow the rinse aid compartment and wipe up any spills.

In order to change the rinse aid level, follow the below steps before turning on the machine:

- Push the programme button and hold it down.
- Turn on the machine.
- Hold down the programme button until “rA” disappears from the display. Rinse aid set follows water hardness set.
- The machine will display the current setting.
- Set the level by pushing the programme (+) and delay (-) buttons.
- Switch off the machine to save the setting.

The factory setting is “4”.

If the dishes are not drying properly or are spotted, increase the level. If blue stains form on your dishes, decrease the level

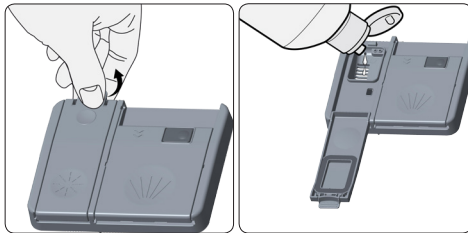

Level	Brightener Dose	Indicator
1	Rinse-aid not dispensed	r1 is shown on the display.
2	1 dose is dispensed	r2 is shown on the display.
3	2 doses are dispensed	r3 is shown on the display.
4	3 doses are dispensed	r4 is shown on the display.
5	4 doses are dispensed	r5 is shown on the display.

## 5. LOADING YOUR DISHWASHER

For best results, follow these loading guidelines.

We recommend that you place large items (pots, pans, lids, plates and bowls) which are heavily soiled in the lower basket.

The upper basket is designed for delicate and lighter dishware such as glasses, coffee and tea cups and saucers. Position the dishes so that they will not get moved by the spray of water.

Cutlery should be placed in the cutlery basket. Items should be loaded individually into the appropriate slots with their handles downwards. Long utensils should be placed horizontally on the baskets.



**WARNING:** Take care not to obstruct the rotation of spray arms.

### 5.1. Recommendations

Remove any coarse residue on dishes before placing the dishes in the machine. Start the machine with full load.



Do not overload the drawers or place dishes in the wrong basket.



**WARNING:** Always place sharp utensils with the sharp point down and open utensils with their openings down.

## Upper Basket

### Height adjustment

Turn the Rail Stop Clips, at the ends of the rails, to the sides to open them (as shown in the image below), then pull out and remove the basket. Change the position of the wheels, then reinstall the basket to the rail, making sure to close the Rail Stop Clips. When the upper basket is in the higher position, large items such as pans can be placed on the lower basket.

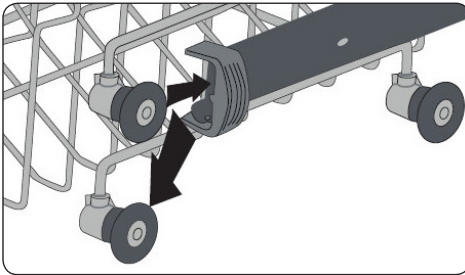
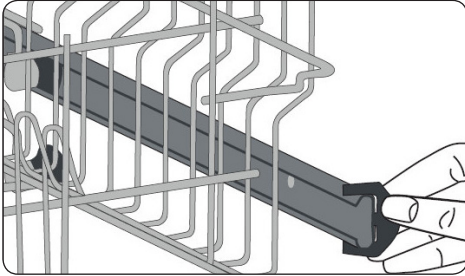

### Height Adjustable Rack (peg type)

The height adjustable racks enable glasses and cups to be placed on or under the racks. The racks can be adjusted to 2 different heights. Cutlery and utensils can also be placed on the racks horizontally.

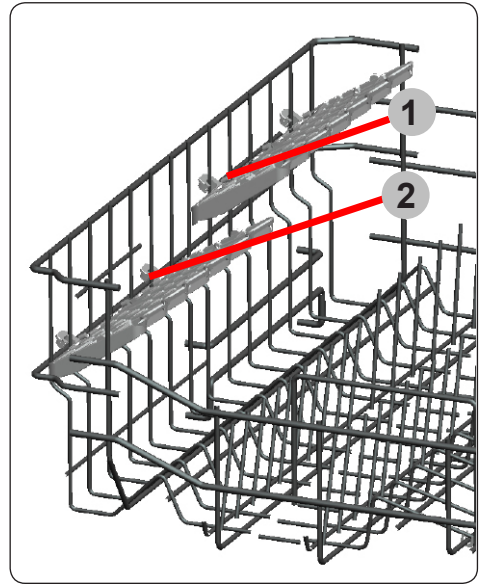

### Height Adjustable Rack (peg type)

The foldable racks in the upper basket enable the placement of large items such as pots and pans. Each section can be folded separately. The foldable racks can be either raised up or folded down.

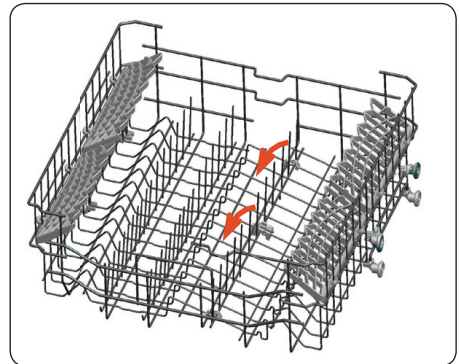

## Four Folding Racks

(15 pc)

The folding racks allow easier placement of larger items, such as pots and pans. Each section can be folded separately. The racks can be raised up, or folded down, as shown in the images.

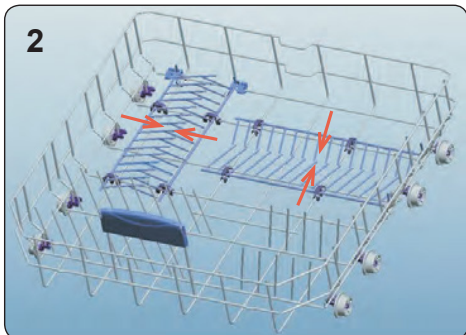
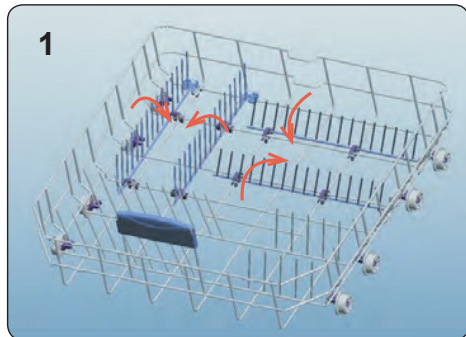

### Upper Cutlery Basket

The upper cutlery basket is designed for the placement of large and small cutlery and utensils.

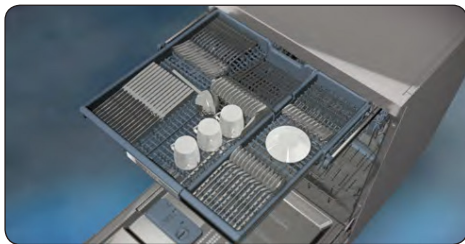

The basket is easily removed from the dishwasher, therefore allows ease of use when removing your items, along with the

basket, after washing.

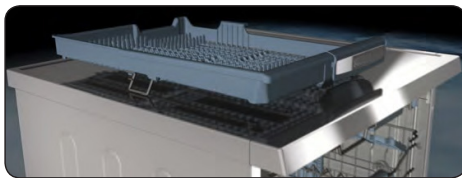

The upper cutlery basket is composed of two pieces that can be separately removed. Remove the left or right section of the cutlery basket in order to obtain more space for items in the upper basket.



**WARNING:** Knives and other sharp objects must be placed horizontally in the cutlery basket.

**5.2. Alternative Basket Loads**  
**Lower Basket**

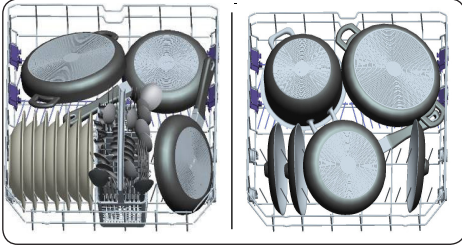

**Top basket**

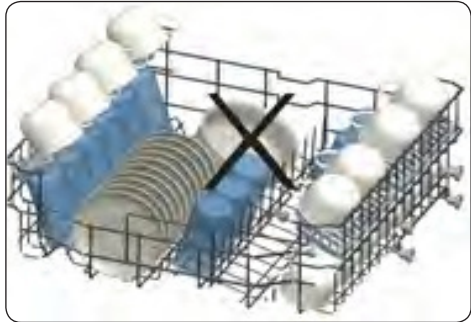
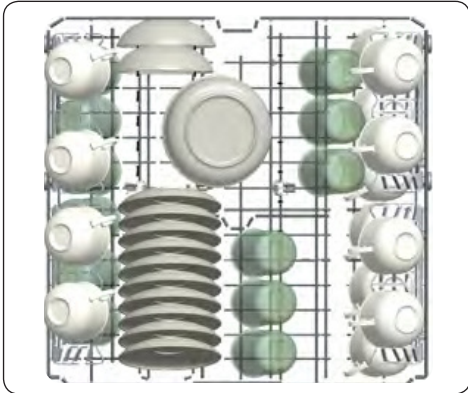
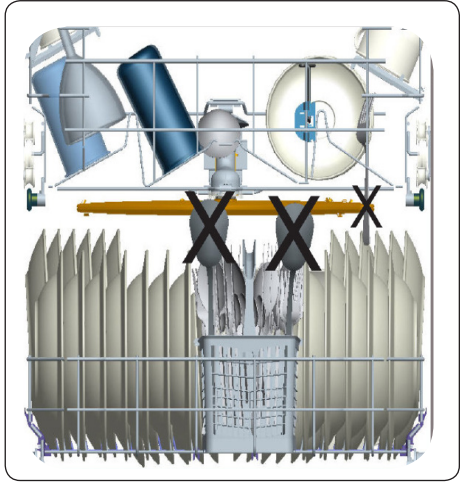

**Incorrect loads**

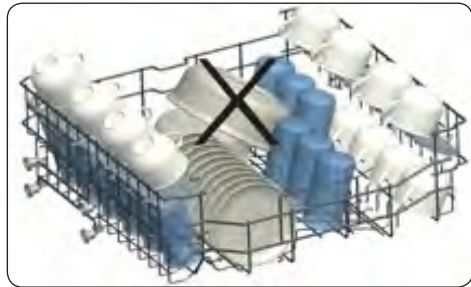
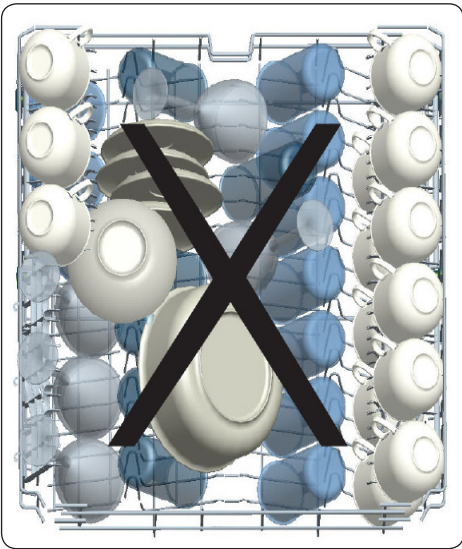

## 6. PROGRAMME TABLE

Programme	Duration (min)	Description
Mini 14'	14	Fast programme intended for recently used dishes which are lightly soiled. Suitable for 4 place settings.
Quick 30'	30	Quick wash programme for lightly soiled dishes.
Eco	138	Standard programme for dishes which are used daily but are not heavily soiled.
Dual Pro Wash	113	For both lightly soiled delicate glassware and heavily soiled crockery at the same time.
Super 50'	50	A faster programme for dishes which are used daily but are not heavily soiled.
Hygiene	123	For heavily soiled dishes which require hygienic washing.
Auto Delicate	64-92	Automatic programme for delicate dishes which are not heavily soiled.
Auto Intensive	111-179	Automatic programme for heavily soiled dishes.



**NOTE:** PROGRAMME DURATION MAY CHANGE ACCORDING TO THE AMOUNT OF DISHES, TAP WATER, AMBIENT TEMPERATURE AND SELECTED ADDITIONAL FUNCTIONS.

- Only use powder detergent in short programmes.
- Short programmes do not include a drying step.
- To assist drying, we recommend partially opening the door after the programme has finished.

## 7. THE CONTROL PANEL

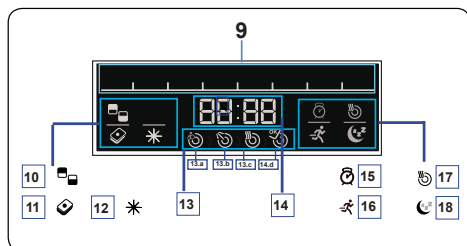
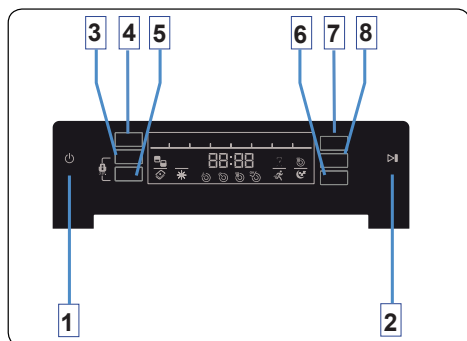

1. On/Off button
2. Start/Standby button
3. Half Load button
4. Programme button
5. Tablet Detergent button
6. Extra button
7. Delay button
8. Extra Drying button
9. Programme Display
10. Half Load symbol
11. Tablet Detergent symbol
12. Rinse Aid Lack Warning symbol
13. Program Status Display
  - a- Washing Phase symbol
  - b- Rinse Phase symbol
  - c- Drying Phase symbol
  - d- End symbol
14. Remaining Time/Delay Time/  
Programme Time Display
15. Delay symbol
16. Extra Fast symbol
17. Extra Drying symbol
18. Silent Wash symbol

### Starting the Machine and Selecting a Programme

Press the Power On/Off button (1), the display (9) will show the most recently selected programme.

Select the programme most suitable for your dishes using the Programme button (4).

Additional functions (3, 5, 6, 7, 8).

**NOTE:** Press the Half Load button (3) to select the area of the dishwasher containing dishes to be washed. You can select both baskets, the upper basket only, or the lower basket only. Press the button until the symbol corresponding to the basket containing the dishes to be washed illuminates. Dishes placed in other areas will not be washed.

**NOTE:** Press the Tablet Detergent button (5) when using a combined detergent that contains rinse aid or other extras. The Tablet Detergent Symbol (11) will remain on as long as it is selected.

**NOTE:** Press the Extra Drying button (8) to add extra drying steps to a programme in order to obtain drier dishes. The Extra Drying Indicator (17) will illuminate.

**NOTE:** Press the Delay button (7) before a programme starts to adjust the delayed programme start time. The Delay symbol (15) will illuminate.

**NOTE:** Press the Extra Fast/Silent button (6) once to activate the Extra Fast function. The Extra Fast symbol (16) will illuminate and the duration of the selected programme will decrease, providing more economical water usage. Pressing the button twice will activate the Extra Silent function. The Extra Silent symbol (18) will illuminate, providing a more sensitive and silent washing operation.

Press the Start/Standby button (2) to start the selected programme.

The display (14) will show the symbols

corresponding to the status of the programme in operation. While the Drying symbol is displayed, the machine will remain silent for 45 to 50 minutes. The Remaining Time Display shows the programme durations and the time remaining of the programme in operation.

 **NOTE:** A programme may take a different amount of time to complete than initially stated on the display. This is dependent on the ambient temperature, the temperature of the mains water, and the amount of dishes in the dishwasher.

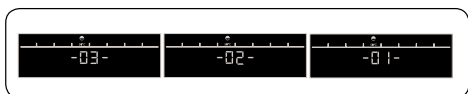

 **NOTE:** Simultaneously press the Half Load (3) and Tablet Detergent (5) buttons for 3 seconds to activate/deactivate the Child Lock. When it is first activated, "CL" will show on the Remaining Time display for 2 seconds. When it is deactivated, "CL" will flash twice.

 **NOTE:** When there is insufficient rinse aid, the Rinse Aid Lack Warning symbol (12) will illuminate to indicate the rinse aid chamber needs filling.

## 7. THE CONTROL PANEL

### 7.1. Changing a Programme

Follow the steps below to change a programme while in operation.

- Press the Start/Standby button (2).
- Select a new programme using the Programme button (4).
- Press the Start/Standby button to start the selected programme.
- The new programme will resume the course of the old programme.

### 7.2. Cancelling a Programme

Follow the steps below to cancel a programme while in operation.

- Press and hold the Start/Standby button (2) for 3 seconds.

- The display will count down from 3 to 1. When it finishes, the time remaining for cancellation will show on the display.

The water discharge process will start when the remaining time finishes and the End symbol will illuminate.

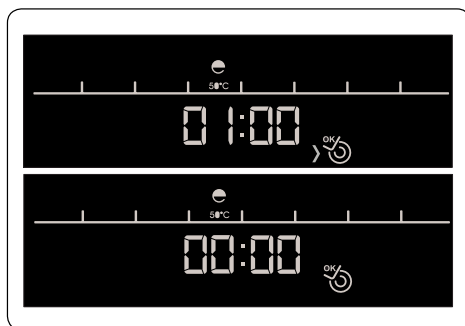

### 7.3. Switching Off the Machine

When the End symbol illuminates, switch off your machine using the On/Off button. Disconnect the plug and turn off the water tap.

 **NOTE:** Do not open the door before the End symbol illuminates.

 **NOTE:** Leave the door of your machine slightly open at the end of a wash programme to speed up drying.

 **NOTE:** If the door of your machine is opened or the power is cut during operation, the programme will continue when the door is closed or the power returns.

## 8. CLEANING AND MAINTENANCE

Cleaning your Dishwasher is important to maintain the machine's service life.

Oil and lime may build up in your Dishwasher over time. If this occurs:

- Fill the detergent compartment but do not load any dishes. Select a programme which runs at high temperature and run the Dishwasher empty. If this does not clean your Dishwasher sufficiently, use a cleaning agent designed for use with dishwashers.
- **Wipe the door seals regularly with a damp cloth to remove any accumulated residue.**

### 8.1. Cleaning machine and filters

Clean the filters and spray arms at least once a week. If any food waste remains on the coarse and fine filters, remove them and clean them thoroughly with water.

- a) Micro Filter      b) Coarse Filter  
c) Metal Filter

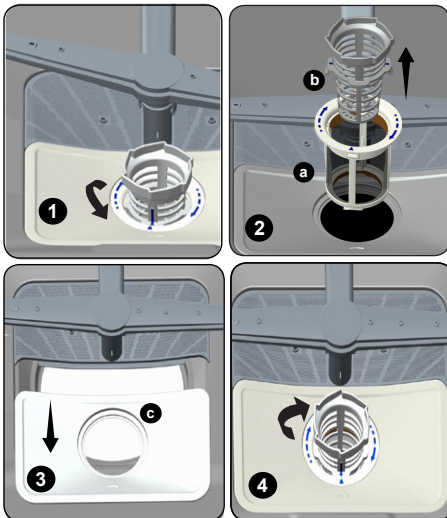

To remove and clean the filter combination, turn it counter clockwise and remove it by lifting it upwards (1). Pull the coarse filter out of the micro filter (2). Then pull and remove the metal filter (3). Rinse the filter with lots of water until it is free of residue. Reassemble

the filters. Replace the filter insert, and rotate it clockwise (4).

- Never use your Dishwasher without a filter.
- Incorrect fitting of the filter will reduce the washing effectiveness.
- Clean filters are necessary for proper running of the machine.

### 8.2. Spray arms

Make sure that the spray holes are not clogged and that no food waste is stuck to the spray arms. If there is any clogging, remove the spray arms and clean them under water. To remove the upper spray arm undo the nut holding it in position by turning it clockwise and pulling it downwards. Make sure that the nut is properly tightened when refitting the upper spray arm.

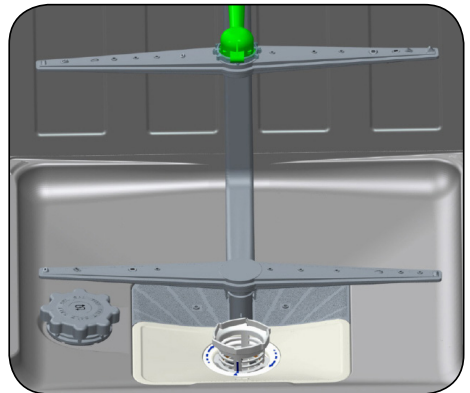

## 9. TROUBLESHOOTING

FAULT	POSSIBLE CAUSE	TROUBLESHOOTING
The programme does not start.	Your Dishwasher is not plugged in.	Plug your Dishwasher in.
	Your Dishwasher is not switched on.	Switch your Dishwasher on by pressing the On/Off button.
	Fuse blown.	Check your indoor fuses.
	Water inlet tap is closed.	Turn on the water inlet tap.
	Your Dishwasher door is open.	Close the Dishwasher door.
	Water inlet hose and machine filters are clogged.	Check the water inlet hose and machine filters and make sure they are not clogged.
Water remains inside the machine.	Water drain hose is clogged or twisted.	Check the drain hose, then either clean or untwist it.
	The filters are clogged.	Clean the filters.
	The programme is not finished yet.	Wait until the programme is finished.
Machine stops during washing.	Power failure.	Check mains power.
	Water inlet failure.	Check water tap.
Shaking and hitting noises are heard during a wash operation.	The spray arm is hitting the dishes in the lower basket.	Move or remove items blocking the spray arm.
Partial food wastes remain on the dishes.	Dishes placed incorrectly, sprayed water not reaching affected dishes.	Do not overload baskets.
	Dishes leaning each another.	Place dishes as instructed in the section on loading your dishwasher.
	Not enough detergent used.	Use the correct amount of detergent, as instructed in the programme table.
	Wrong wash programme selected.	Use the information in the programme table to select the most appropriate programme.
	Spray arms clogged with food waste.	Clean the holes in the spray arms with thin objects.
	Filters or water drain pump clogged or filter misplaced.	Check the drain hose and filters are correctly fitted.

FAULT	POSSIBLE CAUSE	TROUBLESHOOTING
Whitish stains remains on dishes.	Not enough detergent used.	Use the correct amount of detergent, as instructed in the programme table.
	Rinse aid dosage and/or water softener setting set too low.	Increase rinse aid and/or water softener level.
	High water hardness level.	Increase water softener level.
Dishes do not dry.	Drying option is not selected.	Select a programme with a drying option.
	Rinse aid dosage set too low.	Increase rinse aid dosage setting.
Rust stains form on the dishes.	Stainless-steel quality of the dishes is insufficient.	Use only dishwasher-proof sets.
	A poor mains grounding.	Consult a qualified electrician immediately.
Detergent remains in the detergent compartment.	Detergent was added when the detergent compartment was wet.	Make sure detergent compartment is dry before use.

## AUTOMATIC FAULT WARNINGS AND WHAT TO DO

TROUBLE CODE	POSSIBLE FAULT	WHAT TO DO
F5	Insufficient water	Make sure the water inlet tap is open and water is flowing
		Separate the inlet hose from the tap and clean the filter of the hose.
		Contact for service if the error continues.
F3	Continuous water input	Close the tap and contact for service.
F2	Inability to discharge water	Water discharge hose and filters may be clogged.
		Cancel the program.
		If the error continues, contact for service.
F8	Heater error	Contact for service.
F1	Overflow	Unplug the machine and close the tap.
		Contact for service.
FE	Faulty electronic card	Contact for service.
F7	Overheating	Contact for service.
F9	Divisor position error	Contact for service.
F6	Faulty heater sensor	Contact for service.

## 10. PRACTICAL INFORMATION

- When the machine isn't in operation:
  - Disconnect the plug and close the tap.
  - Leave the door slightly open to prevent odour formation.
- Select the dry option to remove water droplets.
- Place dishes in the machine properly to achieve the best energy consumption, washing and drying performance. Please see the programme and consumption table for more information.
- Rinse dirty dishes before placing them in the dishwasher.
- Do not place the machine near a refrigerator because it will reach high temperatures.
- If the machine is located in an area that is at risk of freezing, close the tap, disconnect the inlet hose from the tap and drain the water inside the hose and the machine completely.



Worldwide Appliances Pty Limited  
A.B.N. 45868077422

Office:

48-50 Moore Street, Leichhardt N.S.W 2040

Post:

Locked Bag 3000, Annandale, N.S.W 2038

P: 1300 694 583

## WARRANTY REGISTRATION

Your ongoing satisfaction with your artusi product is important to us. We ask that you complete the enclosed Warranty Registration Card and return it to us so that we have a record of the artusi product purchased by you.

## PRIVACY

Worldwide Appliances respects your privacy and is committed to handling your personal information in accordance with the National Privacy Principles and the Privacy Act 1988 (Cth). A copy of the Worldwide Appliances Privacy Policy is available at [www.artusi.com.au](http://www.artusi.com.au). Worldwide Appliances will not disclose any personal information set out in the Warranty Registration Card ("Personal Information") without your consent unless required by:

1. law;
2. any Worldwide Appliances related company;
3. any service provider which provide services to artusi or assist artusi in providing services (including repair and warranty services) to customers. Our purpose in collecting the Personal Information is

to keep a record of the artusi product purchased by you, in order to provide a better warranty service to you in the unlikely event that there is a problem with your artusi product. Worldwide Appliances may contact you at any one or more of the address, email address or telephone numbers set out in the Warranty Registration Card. Please contact artusi on 1300 694 583 should you not wish to be contacted by Worldwide Appliances.

## WARRANTY

### 1. Warranty

Worldwide Appliances warrants that each artusi product will remain, for a period of either 12 months or 24 months of warranty. All Warranties are valid from the original date of purchase, And warranty claims must be accompanied by the proof of purchase.

24 months warranty products:

All Built-in Appliances – Limited to Ovens, Gas, Induction and Electric Cooktops, and All Rangehoods

Freestanding Cookers - Gas and Electric Models (900mm Width)

Dishwashers - Freestanding, Fully Integrated, Semi Integrated and built-in

12 months warranty products:

Freestanding Cookers - Gas and Electric Models in 50cm, 54cm and 60cm Widths

Portable Appliances\* – Benchtop Models and Portable Gas Models

### 2. What is not Covered by the Warranty.

The Warranty does not apply if an artusi product is defective by a factor other than a defect arising in the manufacture of the artusi product, including but not limited to:

- (a) damage through misuse (including failure to maintain, service or use with proper care), neglect, accident or ordinary wear and tear (including deterioration of parts and accessories and glass breakage);
- (b) use for purpose for which the artusi product was not sold or designed;
- (c) use or installation which is not in accordance with any specified instructions for use or installation;
- (d) use or operation after a defect has occurred or been discovered;
- (e) damage through freight, transportation or handling in transit (other than when Worldwide Appliances is responsible);
- (f) damage through exposure to chemicals, dusts, residues, excessive voltage, heat, atmospheric conditions or other forces or environmental factors outside the control of Worldwide Appliances;
- (g) repair, modification or tampering by the purchaser or any person other than Worldwide Appliances, an employee of Worldwide Appliances or an authorised artusi service contractor\*;
- (h) use of parts, components or accessories which have not been supplied or specifically approved by artusi.
- (i) damage to surface coatings caused by cleaning or maintenance using products not recommended in the artusi product handbook provided to the purchaser upon purchase of the artusi product;
- (j) damage to the base of an electric oven due to items having been placed on the base of the oven cavity or covering the base, such as aluminium foil (this impedes the transfer of heat from the element to the oven cavity and can result in irreparable damage); or
- (k) damages, dents or other cosmetic imperfections not affecting the performance of the artusi in respect of an artusi product purchased as a "factory second" or from display

The Warranty does not extend to light globes used in artusi products.

### 3. Domestic Use

Each artusi product is made for domestic use. This Warranty may not extend to artusi products used for commercial purposes.

**Continued over...**

#### 4. Time for Claim under the Warranty

You must make any claim under this Warranty within twenty eight (28) days after the occurrence of an event which gives rise to a claim pursuant to the Warranty, by booking a service call on the telephone number below.

#### 5. Proof of Purchase

Customers must retain proof of purchase in order to be eligible to make a warranty claim in respect of an artusi product.

#### 6. Claiming under the Warranty

Customers will bear the cost of claiming under this Warranty unless Worldwide Appliances determines the expenses are reasonable, in which case the customer must claim those expenses by providing written evidence of each expense to Worldwide Appliances at the address on the Warranty Registration Card.

#### 7. Statutory Rights

(a) These terms and conditions do not affect your statutory rights.

(b) The limitations on the Warranty set out in this document do not exclude or limit the application of the consumer guarantees set out in the Act or any other equivalent or corresponding legislation in the relevant jurisdiction where to do so would:

(i) contravene the law of the relevant jurisdiction; or

(ii) cause any part of the Warranty to be void.

(c) Worldwide Appliances excludes indirect or consequential loss of any kind (including, without limitation, loss of use of the artusi product) and (other than expressly provided for in these terms and conditions) subject to all terms, conditions and warranties implied by custom, the general law, the Act or other statute.

(d) The liability of Worldwide Appliances to you

for a breach of any express or non-excludable implied term, condition or warranty is limited at the option of Worldwide Appliances to:

(i) replacing or repairing the defective part of the artusi product;

(ii) paying the cost of replacing or repairing the defective part of the artusi product;

(iii) replacing the artusi product; or

(iv) paying the cost of replacing the artusi product.

(e) Our goods come with guarantees that cannot be excluded under the Australian Consumer Law. You are entitled to a replacement or refund for a major failure and for compensation for any other reasonably foreseeable loss or damage. You are also entitled to have the goods repaired or replaced if the goods fail to be of acceptable quality and the failure does not amount to a major failure.

#### 8. Defects

Any part of an artusi product deemed to be defective and replaced by Worldwide Appliances is the property of Worldwide Appliances. Worldwide Appliances reserves the right to inspect and test artusi products in order to determine the extent of any defect and the validity of a claim under the Warranty.

\*To locate your closest artusi authorised service agent please contact us on 1300 652 100 or visit [www.artusi.com.au](http://www.artusi.com.au)

ALL SERVICE CALLS MUST BE BOOKED THROUGH AN AUTHORISED DEALER OR WARRANTY DEPARTMENT ON 1300 652 100 OR [stokesaps.com.au/artusi-service](http://stokesaps.com.au/artusi-service)

01032014



Warranty Card tear off

WARRANTY REGISTRATION CARD  
01052013

Please complete and send to ARTUSI at: REPLY PAID 83617  
LEICHHARDT NSW 2040

Last Name:		First Name:	
Address:			
State:	Postcode:	Email:	
Home Phone:		Mobile:	
Purchase Date: / /		(Please attach proof of purchase to validate warranty)	

MODEL NUMBER	SERIAL NUMBER (if you cannot locate the serial number please call ARTUSI on 1300 694 583)
1	
2	
3	
4	

01032014







#### DISCLAIMER

Worldwide Appliances PTY LTD, trading as ARTUSI, is continually seeking ways to improve the design specifications, aesthetics and production techniques of its products. As a result alterations to our products and designs take place continually. Whilst every effort is made to produce information and literature that is up to date, this brochure should not be regarded as an infallible guide to the current specifications, nor does it constitute an offer for the sale of any particular product. Product dimensions indicated in our literature is indicative only. Actual product only should be used to define dimension cutouts. Distributors, and retailers are not agents of ARTUSI and are not authorised to bind ARTUSI by any express or implied undertaking or representation.

ARTUSI OFFICES ARE OPEN DAILY FROM 9AM-5PM AND SATURDAYS 10AM-4PM

NSW & ACT (HEAD OFFICE)  
48-50 MOORE STREET  
LEICHHARDT  
F 02 8569 4699

VIC, TAS & SA  
1211 TOORAK ROAD  
CAMBERWELL  
F 03 9809 2155

QLD  
1/42 CAVENDISH ROAD  
COORPAROO  
F 07 3397 0850

WA & NT  
UNIT 10/55 HOWE STREET  
OSBORNE PARK  
F 08 9201 9188

NZ  
PO BOX 11160  
SOCKBURN CHRISTCHURCH  
F 03 344 5906

P: 1300 649 583

ARTUSI.COM.AU

