

# Owner's Manual Manual Del Propietario



## Vacuum Cleaner Aspiradora

Model , Modelo 116.36932  
116.36933

### IMPORTANT

Before returning this product-

For replacement parts, please contact:

Sears Parts and Repair Center  
**(1-800-488-1222)**

Anytime, day or night  
(U.S.A. only)

For any other issue, please contact:

Vacuum Cleaner Help Line  
**(1-877-531-7321)**

7:30am-4:00pm EST, M-F  
(U.S.A. and Canada)



ENGLISH

ESPAÑOL

### CAUTION:

Read and follow all safety and operating instructions before first use of this product.

### CUIDADO:

Lea y sigue todas las instrucciones de operación y seguridad antes del uso de este producto.

Sears, Roebuck and Co., Hoffman Estates, IL 60179 U.S.A.  
[www.sears.com](http://www.sears.com)

Part No. CØ1ZCSR3ØUØØ-KCØ1ZCSRZØUØ

Printed in Mexico  
Impreso en Mexico

## TABLE OF CONTENTS

<b>Before Using Your New Vacuum Cleaner</b> .....	2	<b>Vacuuming Tips</b> .....	13
<b>Kenmore Vacuum Cleaner Warranty</b> .....	3	<b>Performance/Safety Features</b> .....	14-15
<b>Important Safety Instructions</b> .....	4	<b>Vacuum Cleaner Care</b> .....	16
<b>Parts and Features</b> .....	5	<b>Vacuum Cleaner Storage</b> .....	16
<b>Assembly Instructions</b> .....	6-7	<b>Cleaning Exterior and Attachments</b> .....	16
<b>Operating Instructions</b> .....	7	<b>Dust Bin Cleaning</b> .....	17
<b>Cord Release</b> .....	7	<b>Primary Filter Removal and Cleaning</b> .....	18-19
<b>Releasing the Handle</b> .....	8	<b>Exhaust Filter Replacement</b> .....	19
<b>Touch Control</b> .....	8	<b>Light Bulb Replacement</b> .....	20
<b>inteliCLEAN</b> .....	9	<b>Agitator Cleaning</b> .....	21
<b>Gentle Sweep Function</b> .....	10	<b>Clog Removal</b> .....	21
<b>Pile Height Selection and Setting</b> .....	10	<b>Troubleshooting</b> .....	22
<b>Attachments</b> .....	11-12	<b>Requesting Assistance Or Service</b> .....	back page
<b>Attachment Use Table</b> .....	13		

## BEFORE USING YOUR NEW VACUUM CLEANER

Please read this guide. It will help you assemble and operate your new Kenmore vacuum cleaner in the safest and most effective way.

For more information about vacuum cleaner care and operation, call your nearest Sears store. You will need the complete model and serial numbers when requesting information. Your vacuum cleaner's model and serial numbers are located on the Model and Serial Number Plate.

Use the space below to record the model number and serial number of your new Kenmore vacuum cleaner.

Model No. \_\_\_\_\_

Serial No. \_\_\_\_\_

Date of Purchase \_\_\_\_\_

Keep this book and your sales check (receipt) in a safe place for future reference.

## KENMORE VACUUM CLEANER WARRANTY

### One Year Limited Warranty

When assembled, operated and maintained according to all instructions supplied with the product, if this vacuum cleaner fails due to a defect in material or workmanship within one year from the date of purchase, return it to any Sears store, Sears Parts & Repair Center or other Kenmore outlet for free repair.

If this vacuum cleaner is used for other than private family purposes, this warranty applies for only 90 days from the date of purchase.

**This warranty covers only defects in material and workmanship. Sears will NOT pay for:**

1. Expendable items that can wear out from normal use, including but not limited to filters, belts, light bulbs, and bags.
2. A service technician to instruct the user in correct product assembly, operation or maintenance.
3. A service technician to clean or maintain this product.
4. Damage to or failure of this product if it is not assembled, operated or maintained according to all instructions supplied with the product.
5. Damage to or failure of this product resulting from accident, abuse, misuse or use for other than its intended purpose.
6. Damage to or failure of this product caused by the use of detergents, cleaners, chemicals or utensils other than those recommended in all instructions supplied with the product.
7. Damage to or failure of parts or systems resulting from unauthorized modifications made to this product.

ENGLISH

### Disclaimer of implied warranties; limitation of remedies

Customer's sole and exclusive remedy under this limited warranty shall be product repair as provided herein. Implied warranties, including warranties of merchantability or fitness for a particular purpose, are limited to one year or the shortest period allowed by law. Sears shall not be liable for incidental or consequential damages. Some states and provinces do not allow the exclusion or limitation of incidental or consequential damages, or limitations on the duration of implied warranties of merchantability or fitness, so these exclusions or limitations may not apply to you.

This warranty applies only while this vacuum cleaner is used in the United States and Canada.

This warranty gives you specific legal rights, and you may also have other rights which vary from state to state.

Sears, Roebuck and Co., Hoffman Estates, IL 60179  
Sears Canada Inc., Toronto, Ontario, Canada M5B 2B8

## IMPORTANT SAFETY INSTRUCTIONS

**⚠ WARNING:** Your safety is important to us. To reduce the risk of fire, electrical shock, injury to persons or damage when using your vacuum cleaner, follow basic safety precautions including the following:

Read all instructions in this manual before assembling or using your vacuum cleaner.

Use your vacuum cleaner only as described in this manual. Use only with Sears recommended attachments.

Disconnect electrical supply before servicing or cleaning out the brush area. Failure to do so could result in electrical shock or the brush suddenly starting.

Do not leave vacuum cleaner when plugged in. Unplug from outlet when not in use and before performing maintenance.

To reduce the risk of electrical shock - Do not use outdoors or on wet surfaces.

Do not allow to be used as a toy. Close attention is necessary when used by or near children.

Do not use with a damaged cord or plug. If vacuum cleaner is not working as it should, has been dropped, damaged, left outdoors, or dropped in water, return it to a Sears Service Center.

Do not pull or carry by cord, use cord as a handle, close a door on cord, or pull cord around sharp edges or corners. Do not run vacuum cleaner over cord. Keep cord away from heated surfaces.

Do not unplug by pulling on cord. To unplug, grasp the plug, not the cord.

Do not handle plug or vacuum cleaner with wet hands.

Do not put any objects into openings.

Do not use with any opening blocked; keep free of dust, lint, hair, and anything that may reduce air flow.

Keep hair, loose clothing, fingers, and all parts of body away from openings and moving parts.

Turn off all controls before unplugging.

Use extra care when cleaning on stairs.

Do not put on chairs, tables, etc. Keep on floor.

Do not use vacuum cleaner to pick up flammable or combustible liquids (gasoline, cleaning fluid, perfumes, etc.), or use in areas where they may be present. The fumes from these substances can create a fire hazard or explosion.

Do not pick up anything that is burning or smoking, such as cigarettes, matches, or hot ashes.

Do not use vacuum cleaner without dust bin and/or filters in place.

Always clean the dust bin after vacuuming carpet cleaners or freshener, powders, and fine dust. These products clog the filters, reduce airflow and can cause damage to the vacuum cleaner. Failure to clean the dust bin could cause permanent damage to the vacuum cleaner.

Do not use the vacuum cleaner to pick up sharp hard objects, small toys, pins, paper clips, etc. They may damage the vacuum cleaner or dust bin.

Unplug before connecting Handi-mate Jr.®

You are responsible for making sure that your vacuum cleaner is not used by anyone unable to operate it properly.

## SAVE THESE INSTRUCTIONS

Proper assembly and safe use of your vacuum cleaner are your responsibilities. Your vacuum cleaner is intended for Household use. Read this Owner's Manual carefully for important use and safety information. This guide contains safety statements under warning and caution symbols.

# PARTS AND FEATURES

It is important to know your vacuum cleaner's parts and features to assure its proper and safe use. Review these before using your vacuum cleaner.

Object	Style No.	Part No. in USA	Part No. in Canada
Headlight Bulb	----	20-5248	----
Exhaust Filter	EF-1	20-86889	20-40324
Primary Filter	DCF-2	20-82912	20-40335

ENGLISH

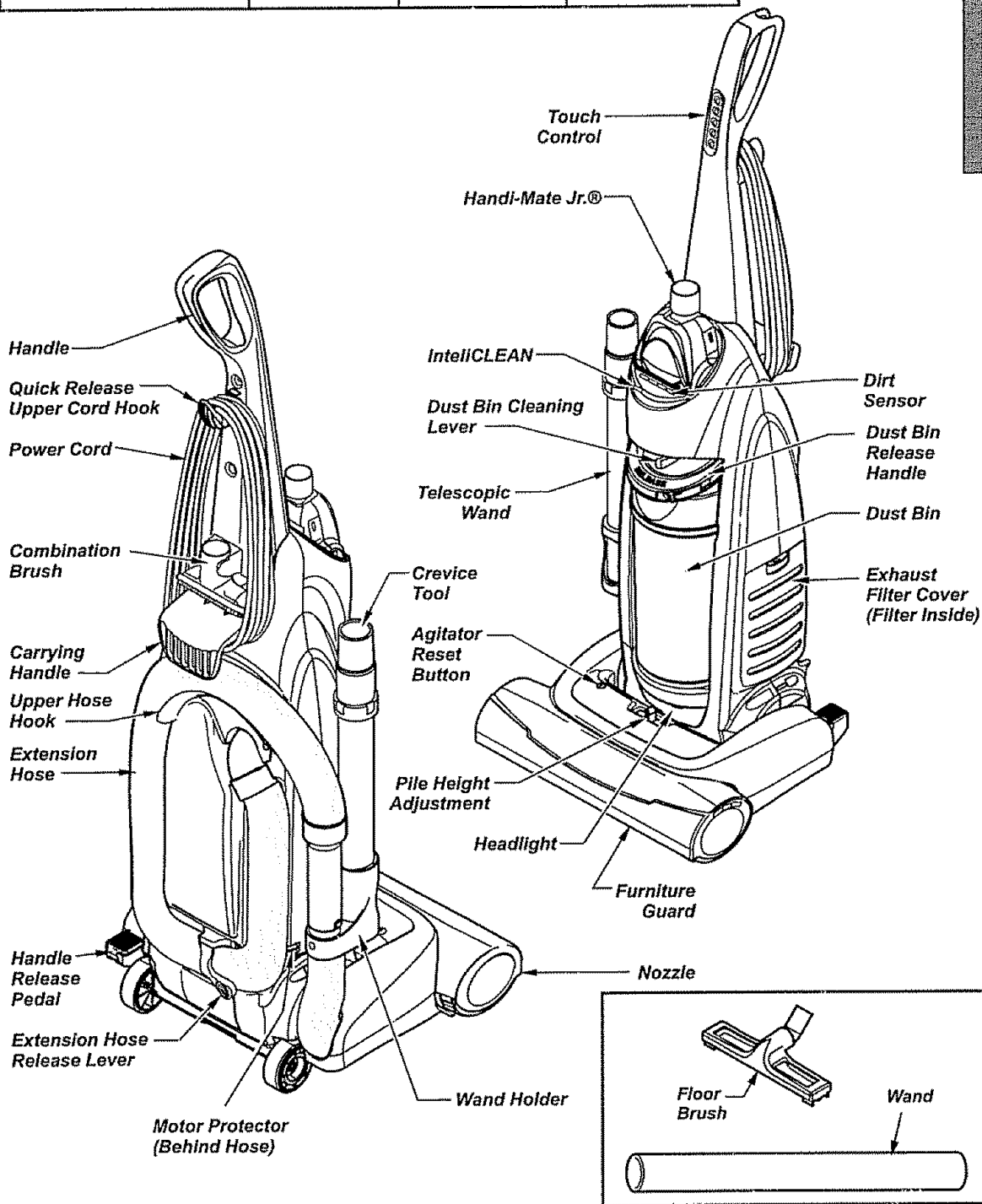



Please pay special attention to these hazard alert boxes, and follow any instructions given. **WARNING** statements alert you to such dangers as fire, electric shock, burns and personal injury. **CAUTION** statements alert you to such dangers as personal injury and/or property damage.

## ASSEMBLY INSTRUCTIONS



### WARNING

#### Electrical Shock Hazard

Do not plug into the electrical supply until the assembly is complete. Failure to do so could result in electrical shock or injury.

Before assembling the vacuum cleaner, check the **PACKING LIST** on the cover of the separate **REPAIR PARTS LIST**. Use this list to verify that you have received all the components of your new Kenmore vacuum cleaner.

### HANDLE ASSEMBLY

Remove the combination brush from the handle to expose the handle mounting hole.

Remove the handle screw from the body of the vacuum cleaner.

Position the handle assembly as shown in the illustration below.

When installing the handle, firmly press the handle onto the body. Secure with handle screw provided.

Begin to tighten the screw with your fingers. It may be necessary to adjust the handle slightly.

Using a screwdriver, tighten handle screw.

Reinstall combination brush.

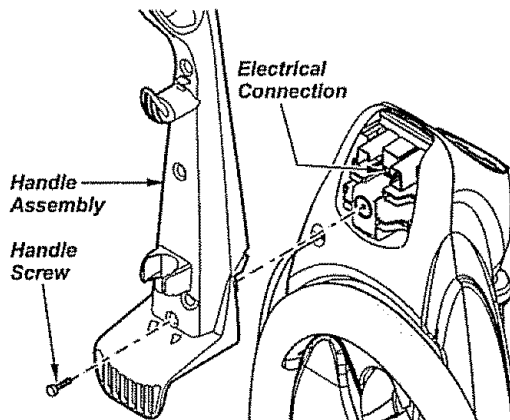

### CAUTION

Do not overtighten.

Overtightening could strip the screw holes.

Do not operate the vacuum cleaner without the screw in place.

### CORD ASSEMBLY

Make sure the quick release upper cord hook is in the upright position. Remove the wire tie from the power cord.

Make sure the power cord is placed into the locking notch on the body as shown. This helps keep the power cord out from under the vacuum cleaner agitator.

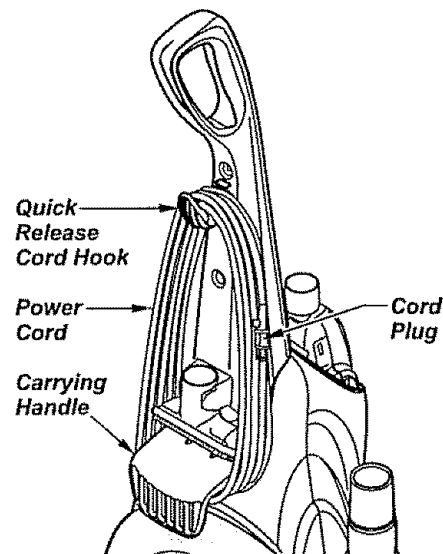
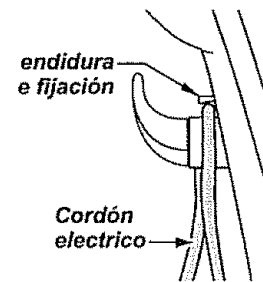

Wrap the power cord around the quick release cord hook and the carrying handle. Lock the power cord plug onto the power cord.

## HANDI-MATE JR.®

For operation of Handi-Mate Jr.® see separate Owner's Manual.

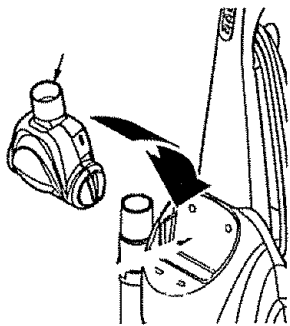

### TO INSERT HANDI-MATE JR.®

Place Handi-Mate Jr.® into the storage compartment.

Rotate the Handi-Mate Jr.® back until it snaps into place.

### TO REMOVE HANDI-MATE JR.®

Rotate Handi-Mate Jr.® out of the storage compartment.

## TELESCOPIC WAND

### PLACEMENT

Place the telescopic wand in the wand holder. Place the crevice tool in the top of the telescopic wand.

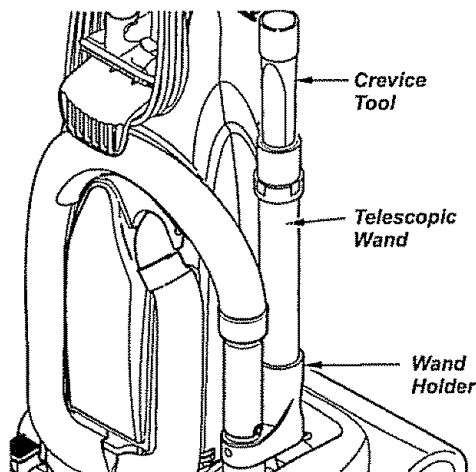

ENGLISH

## OPERATING INSTRUCTIONS

### CORD RELEASE

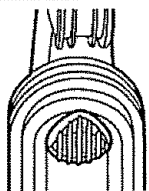

1. Turn the quick release upper cord hook to either side and down to release the power cord.

2. Detach the power cord plug from the power cord and pull the cord off the quick release upper cord hook. Be sure the power cord is still locked into the locking notch of the upper cord hook.

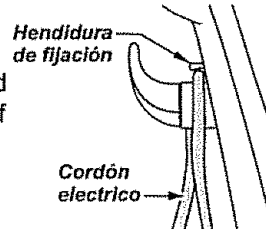

3. Plug the polarized power cord into a 120 Volt outlet located near the floor.

4. To replace cord, turn upper cord hook to the up position, then wrap cord.

### **⚠ WARNING**

- To reduce the risk of electric shock, this vacuum cleaner has a polarized plug (one blade is wider than the other).
- The plug will fit in a polarized outlet only one way. If the plug does not fit fully in the outlet, reverse the plug. If it still does not fit, contact a qualified technician to install the proper outlet. Do not change the plug in any way.

### **⚠ WARNING**

Personal Injury and Product Damage Hazard

- DO NOT place hands or feet under the vacuum cleaner at any time.
- DO NOT use outlets above counters. Damage from cord to items in surrounding area could occur.

## RELEASING THE HANDLE

Release the handle by pressing down on the handle release pedal with your foot and pulling back and down on the handle with your hand.

**Note:** The agitator does not rotate when the vacuum cleaner is in the upright position.

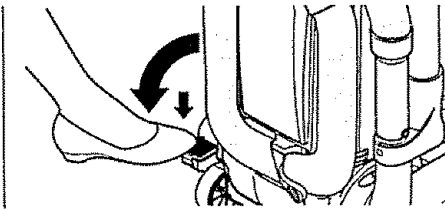

## TOUCH CONTROL

**inteliCLEAN** - Turns **ON** the vacuum cleaner in **inteliCLEAN** mode.

**SUCTION/TOOLS** - Changes the suction level of the vacuum cleaner motor. If the vacuum cleaner is **OFF** and locked in the upright position pressing the **SUCTION** button turns **ON** only the vacuum cleaner motor to **HIGH** for cleaning of most carpets, rugs and fabrics. The agitator starts (in **HIGH** speed) when the vacuum cleaner is lowered into the operating position. Pressing the **SUCTION** button cycles the vacuum cleaner motor through suction levels. **H.M.L.** = **HIGH, MEDIUM, LOW**

**GENTLE/FLOOR** - Turns **ON** the vacuum cleaner motor to **HIGH** suction level and the agitator motor to **LOW** speed level for gentle cleaning of most delicate carpets and rugs. Pressing the **GENTLE/FLOOR** button a second time turns **OFF** the agitator motor for cleaning bare floors. In order to get **MEDIUM** and **LOW** suction levels for cleaning, press the **SUCTION** button to cycle the vacuum cleaner motor through **MEDIUM, LOW, and HIGH** suction levels respectively.

**CARPET** - Turns **ON** the vacuum cleaner

motor to **HIGH** suction level and the agitator motor to **HIGH** speed level for cleaning of most carpets and rugs. In order to get **MEDIUM** and **LOW** suction levels for cleaning, press the **SUCTION** button to cycle the vacuum cleaner motor through **MEDIUM, LOW, and HIGH** suction levels respectively.

**OFF** - Turns **OFF** vacuum cleaner.



MOTOR FUNCTION		
Touch Control Button	Vacuum Cleaner (Suction) Motor	Agitator Motor
OFF	OFF	OFF
CARPET	HIGH	HIGH
GENTLE	HIGH	LOW
FLOOR	HIGH	OFF
SUCTION	HIGH/MEDIUM/LOW	
inteliCLEAN	Variable Power	HIGH/LOW/OFF

## inteliCLEAN

Your Kenmore vacuum cleaner is equipped with the latest technology in floor care. The Kenmore **inteliCLEAN** automatically chooses the right cleaning power for any cleaning need. **Medium** power for everyday pickup, **High** power for normal dirt, and **Maximum** power for deep cleaning high traffic areas.

When **inteliCLEAN** mode is activated the **inteliCLEAN** indicator is green.

To turn **OFF** or de-activate **inteliCLEAN** press the **inteliCLEAN** button or **TOOLS** button.

When there is little or no dirt present the dirt sensor is green, indicating that **inteliCLEAN** power is at **MEDIUM**. At **MEDIUM** power the vacuum cleaner operates at low energy consumption and noise levels.

With normal dirt concentration the dirt sensor is amber, indicating that **inteliCLEAN** power is at **HIGH**. Energy consumption and noise levels increase.

With heavy dirt concentration the dirt sensor is amber and red, indicating that **inteliCLEAN** power is at **MAXIMUM**. The vacuum cleaner operates at its highest energy consumption and noise levels.

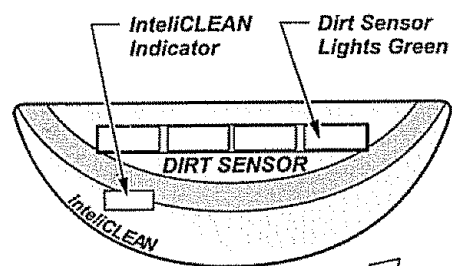

Motor/Fan Speed 

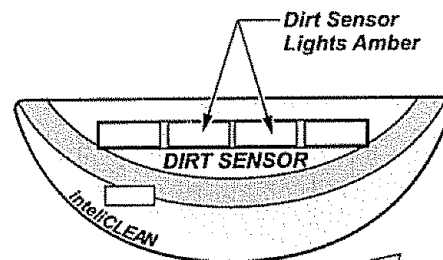

Motor/Fan Speed 

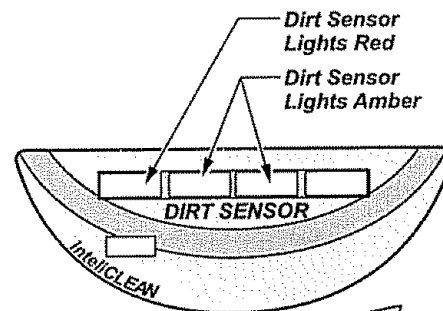

Motor/Fan Speed 

ENGLISH

## GENTLE SWEEP FUNCTION

Your Kenmore Vacuum Cleaner features a two (2) speed, direct drive agitator for cleaning a variety of floor surfaces. Please review the table below before using your vacuum cleaner.

1. Do not use the **CARPET** setting (high speed) for cleaning berber style carpet. The high agitator speed could damage the carpet or cause excessive carpet wear.
2. Use the **GENTLE** setting (low speed) **ONLY** for berber or delicate pile carpeting. The agitator may slow down or stop on thick carpeting, area rugs or throw rugs. If agitator stops and does not restart, see **AGITATOR MOTOR OVERLOAD PROTECTOR**.
3. The **FLOOR** setting may be used for all indoor bare floors including wood, tile, linoleum, slate etc.

Touch Control Setting	Agitator Speed	Bare Floor	Commercial or Low Pile	Berber or Delicate Carpet	Plush	Shag	Area Rug
Carpet (1)	High		✓		✓	✓	✓
Gentle (2)	Low			✓			
Floor (3)	Off	✓					

## PILE HEIGHT SELECTION AND SETTING

**To select a pile height setting:**

Turn off vacuum cleaner. Select a pile height setting by tilting the vacuum cleaner back until front wheels are lifted slightly off the floor.

Slide the adjustment lever to the correct setting.

There are four (4) pile height settings on the vacuum cleaner. Use the **LOW** setting for most low-pile carpets and bare floor cleaning (with agitator **OFF**), and the **HIGH** setting for high-pile carpets like shag carpet, scatter rugs, etc. Use the other settings as needed for carpet heights in between.

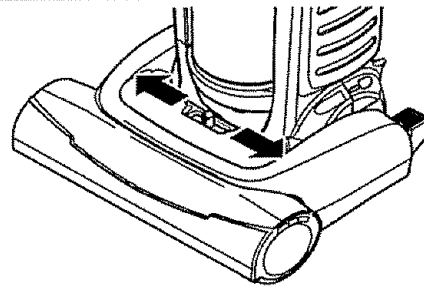

### ! CAUTION

Do not allow vacuum cleaner to remain in one spot for any length of time when the agitator is turning. Damage to carpet may occur.

## ATTACHMENTS

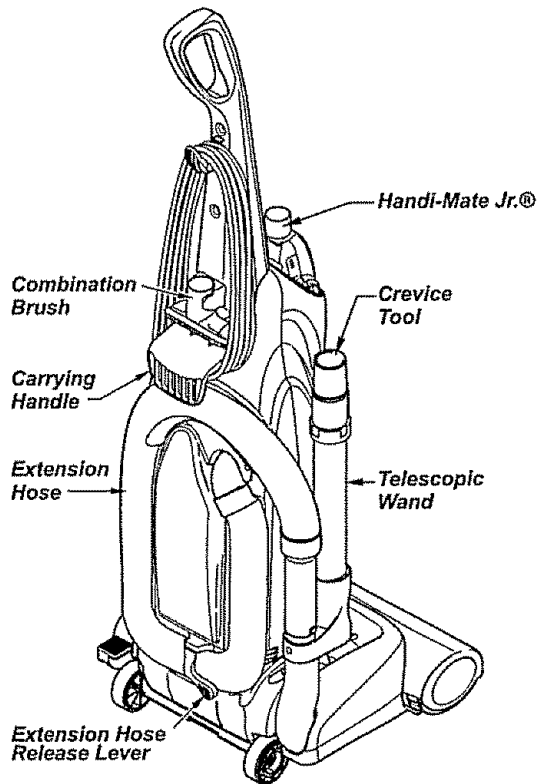

### TO USE ATTACHMENTS

Remove the lower end of the extension hose from the wand holder by grasping the hose collar, twisting, and pulling straight up.

Rotate the extension hose release lever down if maximum reach is needed.

**Note:** The motor protector may open when using attachments or when cleaning new carpet, due to reduced airflow caused by the attachments themselves or caused by new carpet lint filling the dust bin quickly. See the **TROUBLESHOOTING** section.

### **⚠** WARNING

**Electrical Shock And Personal Injury Hazard**

Disconnect electrical supply before servicing or cleaning the vacuum cleaner. Failure to do so could result in electrical shock or personal injury from vacuum cleaner suddenly starting.

### TELESCOPIC WAND WITH SUCTION CONTROL SLIDE

1. Remove the lower end of the extension hose from the wand holder by grasping the hose collar, twisting, and pulling straight up.
2. Remove the telescopic wand from the wand holder.
3. Remove the crevice tool from its storage position in the wand. Turn the locking ring to the **UNLOCK** position.

ENGLISH

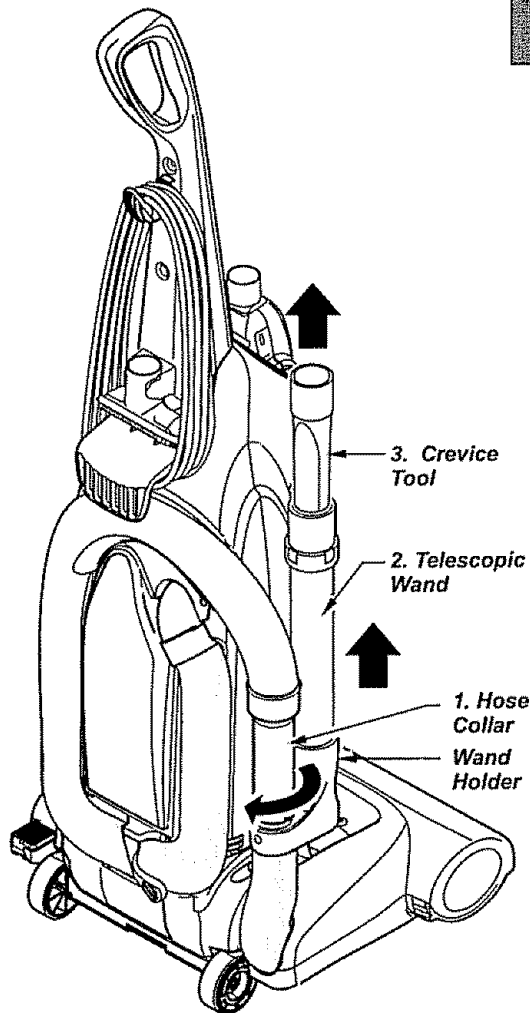

Extend the wand to its full length. Turn the locking ring to the **LOCK** position. Attach the wand onto the open end of the hose.

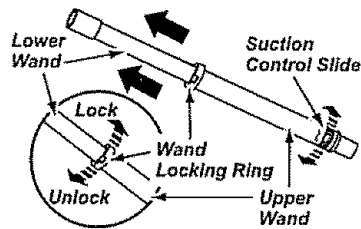

Align the tabs on the wand with the "J" slots in the hose. Push the wand into the hose and twist to the right to lock.

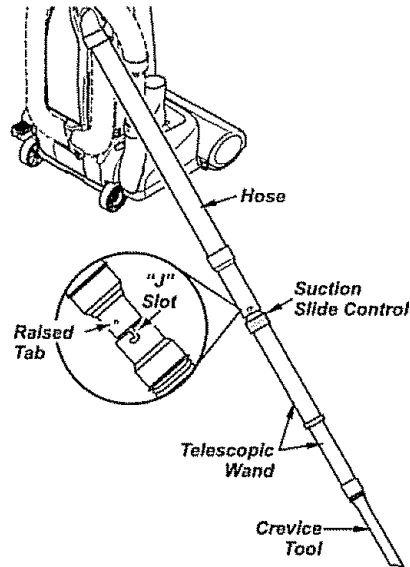

To achieve maximum reach with the attachments, add the crevice tool to the end of the wand by inserting and twisting slightly.

The combination brush can be attached directly to the wand.

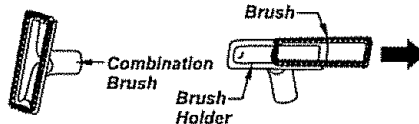

Use the brush holder without the brush for greater suction on furniture cushions or stairs. Use brush holder with brush for cleaning loose surfaces such as drapes.

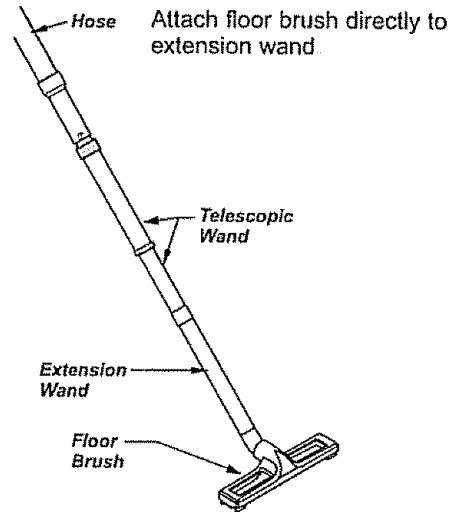

Use the floor brush for cleaning of floors or stairs.

## TO OPERATE SUCTION CONTROL SLIDE

### Telescopic Wand

When using attachments for cleaning draperies, small rugs with low pile and other delicate items, twist the suction control slide to the open position. This slide is located on the telescopic wand, close to the hose.

This will reduce suction for ease of cleaning.

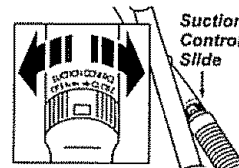

**Note:** Return suction control slide to the closed position for normal cleaning.

## CAUTION

When using attachments, be careful not to overextend the stretch hose when reaching. Trying to reach beyond the hose stretch capability could cause the vacuum cleaner to tip over.

## TO STORE ATTACHMENTS

Remove the combination brush. Snap into appropriate storage location.

Remove crevice tool from the wand by twisting. Lay aside.

Remove the telescopic wand from the hose.

Twist the wand to the left and pull from the hose end.

Unlock the wand by turning the wand locking ring to the **UNLOCK** position.

Slide the lower wand into the upper wand. Turn the wand locking ring to the **LOCK** position.

Place the crevice tool down into the compressed wand. Place the telescopic wand in the wand holder





### CAUTION

**DO NOT** pull the vacuum cleaner around the room by the hose. Property damage or personal injury could result.

ENGLISH

## ATTACHMENT USE TABLE

### CLEANING AREA

ATTACHMENT	Furniture*	Between Cushions*	Drapes*	Stairs	Floors
CREVICE TOOL 	✓	✓		✓	
COMBINATION BRUSH ** 	✓		✓	✓	
FLOOR BRUSH 				✓	✓
Handi-Mate Jr.® 	✓			✓	

\* Always clean attachments before using on fabrics. ✓ = Applicable

\*\* Use the brush holder with out the brush for greater suction on furniture cushions or stairs. Use brush holder with brush for cleaning loose surfaces such as drapes.

## VACUUMING TIPS

### Carpet edges

Guide either side or the front of the nozzle along a baseboard.

### Stairs

Set handle in full upright position. Agitator stops rotating. Use the crevice tool, combination brush or Handi-Mate Jr.®.

### Vacuum cleaner Tipping

When using the attachments keep the extension hose release lever in the locked position when possible. This helps to keep the vacuum cleaner from tipping over when stretching the hose. If additional hose is needed then unlock the release lever and pull out additional hose. Use caution not to tip over vacuum cleaner.

### WARNING

**Personal Injury Hazard**  
Use care if vacuum cleaner is placed on stairs. If it falls, personal injury or property damage could result.

For best cleaning results, keep the airflow passage clear.

Unplug the vacuum cleaner from the outlet before checking.

## PERFORMANCE/SAFETY FEATURES

### MOTOR PROTECTION SYSTEM

#### Motor Protector

This vacuum cleaner has a motor protector by-pass valve which automatically opens to provide cooling air to the vacuum cleaner motor when a clog prevents the normal flow of air to the motor. If the by-pass valve opens to prevent motor overheating and possible damage to the vacuum cleaner, you will notice a change of sound as air rushes through the valve opening.

**To correct problem empty the dust bin. If using attachments, adjust to allow for greater air flow.**

**NOTE:** The motor protector may open when using attachments or when cleaning new carpet, due to reduced airflow caused by the attachments themselves or by new carpet lint filling the dust bin quickly. **To correct problem empty the dust bin. If using attachments, adjust to allow for greater air flow.**

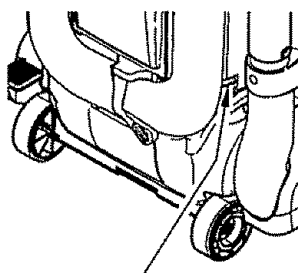

*Motor Protector  
(Behind Hose)*

**Note:** Do not block motor protector.

#### Thermal Protector

This vacuum cleaner has a thermal protector, which automatically trips to protect both the vacuum cleaner and the agitator motor from overheating. If a clog prevents the normal flow of air to the motor, the thermal protector turns the motor off automatically. This allows the motor to cool in order to prevent possible damage to the vacuum cleaner.

**To correct problem:** Turn the vacuum cleaner off and unplug the power cord from the outlet to allow the vacuum cleaner to cool and the thermal protector to reset.

**Check for and remove clogs, if necessary. See CLOG REMOVAL section. Also check and replace any clogged filters. Wait approximately thirty (30) minutes before restarting vacuum cleaner.**

### AGITATOR MOTOR OVERLOAD PROTECTOR

The agitator motor has built-in protection against motor damage should the agitator jam. If the agitator slows down or stops, the agitator overload protector shuts off the agitator motor. The vacuum cleaner motor will continue to run.

**To correct problem:** Turn off and unplug vacuum cleaner, remove obstruction, then press Agitator Motor reset button.

**If the problem persists, have the vacuum cleaner serviced by a Sears or other qualified technician.**

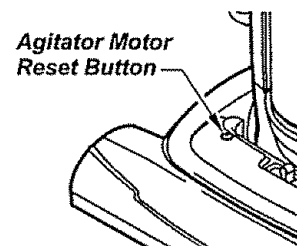

*Agitator Motor  
Reset Button*

## DIRT SENSOR

The electronic dirt sensor is a feature which will detect particles as they pass through the vacuum cleaner.

The dirt sensor indicators are located on the front of the vacuum cleaner above the dust bin.

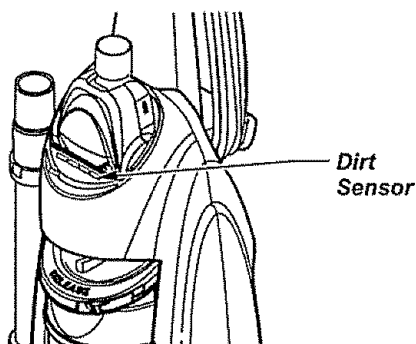

- When little or no dirt is present the dirt sensor is green.
- With medium dirt concentration the dirt sensor is amber.
- With heavy concentration the dirt sensor is red and amber.



### WARNING

**Electrical Shock And Personal Injury Hazard**

**Disconnect electrical supply before performing maintenance to the vacuum cleaner. Failure to do so could result in electrical shock or personal injury from vacuum cleaner suddenly starting.**

## OPERATION

As you vacuum, the amber and red indicator lights will come on and stay on as long as the sensor detects a high concentration of particles passing through the vacuum cleaner.

## TO CLEAN DIRT SENSOR OPTICS

The dirt sensor optics consist of two optic cells located inside the dust bin port. Occasionally, it may become necessary to clean the two optic cells to assure maximum performance.

It is recommended the optic cells be cleaned:

- When the red light stays on continuously.
- When dirt or dust adheres to the optic cells.
- Whenever the dust bin is emptied.

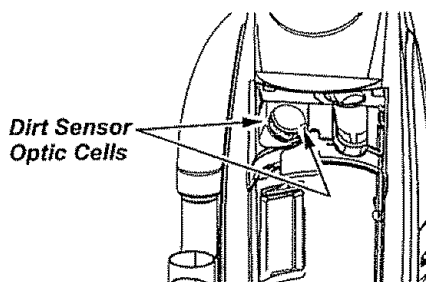

To clean the sensor, wipe the optic cells with a soft, dry cloth. Never use cleaners or liquids as they can help speed the recoating of the optic cells and make it necessary to clean them much sooner than normal. The dirt sensor area can be reached by removing the dust bin.

ENGLISH

## VACUUM CLEANER CARE

Always follow all safety precautions when performing maintenance to the vacuum cleaner.

### **WARNING**

**Electrical Shock And Personal Injury Hazard**

Disconnect electrical supply before servicing or cleaning the vacuum cleaner. Failure to do so could result in electrical shock or personal injury from vacuum cleaner suddenly starting.

## VACUUM CLEANER STORAGE

Gather the cord and wrap it loosely around the upper and lower cord hooks. Lock power cord plug onto the power cord.

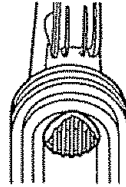

Store the vacuum cleaner in a dry, indoor area, on the floor with the handle locked in the upright position.

### **WARNING**

**Electrical Shock And Personal Injury Hazard**

Wrapping the cord too tightly puts stress on the cord and can cause cord damage. A damaged cord is an electrical shock hazard and could cause personal injury or damage.

## CLEANING EXTERIOR AND ATTACHMENTS

Unplug cord from wall outlet. **DO NOT** drip water on vacuum cleaner.

Clean exterior using a clean, soft cloth that has been dipped in a solution of mild liquid detergent and water, then wrung dry. Wipe dry after cleaning.

To reduce static electricity and dust build-up, wipe outer surface of vacuum cleaner and attachments.

Wash attachments in warm soapy water, rinse and air dry. **Do not clean in dishwasher.**

### **CAUTION**

**Do not use attachments if they are wet. Attachments used in dirty areas, such as under a refrigerator, should not be used on other surfaces until they are washed. They could leave marks.**

## DUST BIN CLEANING

### **! WARNING**

Always unplug power cord from electrical outlet before performing any service on vacuum cleaner.

#### TO REMOVE DUST BIN

Lift dust bin handle located at the top of the dust bin.

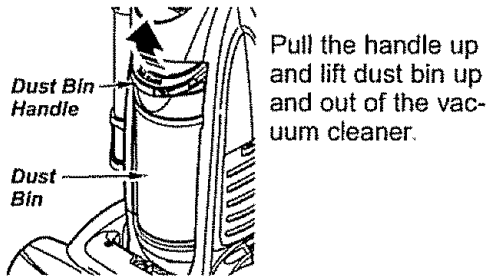

Remove any clogs that might be located in the suction port or filter port area.

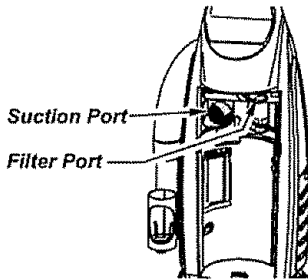

#### TO EMPTY DUST BIN

Before removing debris from dust bin it is a good idea to move the dust bin filter cleaning lever back and forth several times.

Moving the lever back and forth loosens the dust and debris that has attached itself to the filter element inside the dust bin.

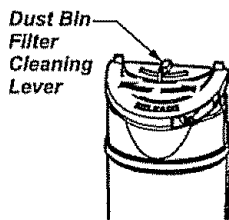

Rotate dust bin handle to the vertical position.

Hold dust bin over a trash container.

Press the dust bin door release button downward to release the door.

The door will swing open and the debris will fall into the trash container.

Shake the dust bin to release any debris that might hang in the filter element.

**Note:** See **PRIMARY FILTER REMOVAL AND CLEANING** section.

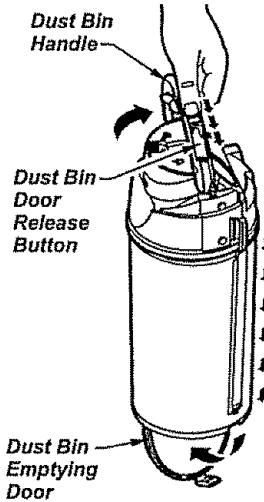

ENGLISH

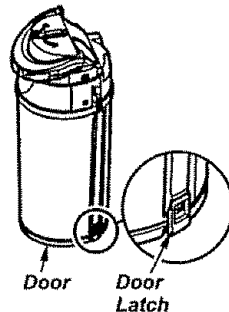

After the dust bin is empty of debris, firmly close the door. Make sure you hear a "click" sound to indicate that the door is fully latched.

#### TO REPLACE DUST BIN

Place dust bin back into vacuum cleaner by inserting the bottom first and tilting back with the dust bin handle raised.

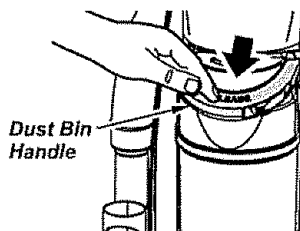
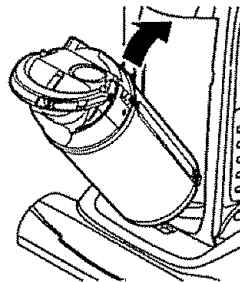

Lower the dust bin handle to lock dust bin in place.

A noticeable "click" should be heard.

## PRIMARY FILTER REMOVAL AND CLEANING

### **WARNING**

**Electrical Shock And Personal Injury Hazard**

Unplug power cord from electrical outlet. Do not operate the vacuum cleaner without the primary or exhaust filters. Be sure the filters are properly installed to prevent motor failure and or electrical shock.

### PRIMARY FILTER

Check primary filter frequently and clean when dirty.

#### TO REMOVE PRIMARY FILTER

Remove the dust bin assembly as outlined in the **DUST BIN CLEANING** section.

Make sure dust bin is free of debris before removing lid and filter. Rotate dust bin lid assembly counterclockwise as indicated on the lid and lift off.

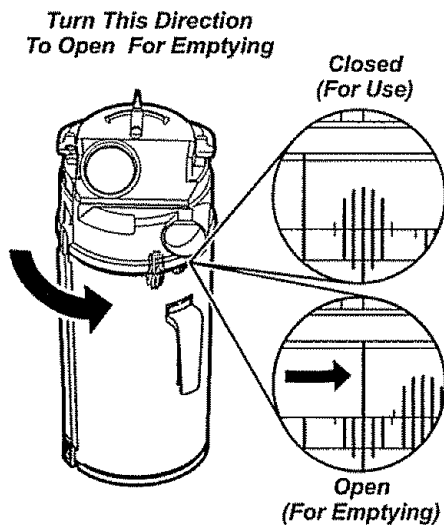

While holding dust bin lid over a trash container grasp primary filter, rotate counterclockwise and lift off.

Clean primary filter by gently tapping over a trash container. Tap on several sides to ensure best cleaning.

Remove primary filter by turning it counterclockwise and pulling out (See arrows on bottom of filter). Rinse with water only as needed, do not use any detergent or soap.

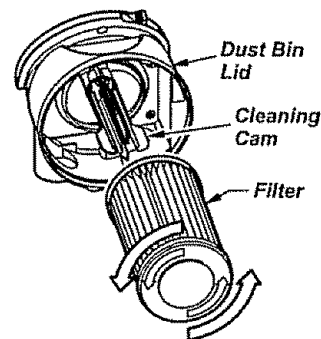

Allow the filter to dry for 24 hours before putting it back into the vacuum cleaner.

When cleaning the filter no longer restores vacuum cleaner's suction to full power you need to replace the filter.

**Note:** See **PARTS AND FEATURES** for the filter number.

#### TO REPLACE PRIMARY FILTER

To replace filter, insert it over cleaning cams as far as it will go. Make sure rubber seal at top of filter is flush against filter supporter, then turn filter clockwise to secure into place. Filter will click and snap when it is secured into place.

**Note:** Under normal use and care, your filter can be expected to last up to 5 years.

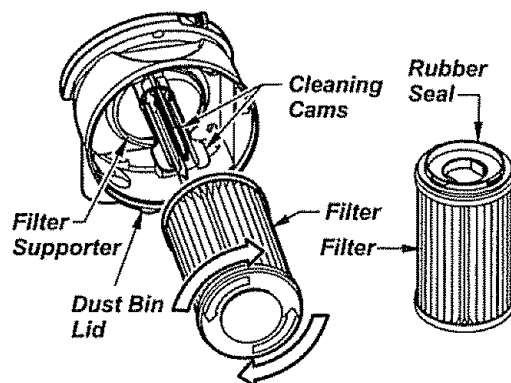

Re-assemble dust bin lid to dust bin. see **To REPLACE DUST BIN LID**.

### TO REPLACE DUST BIN LID

Replace dust bin lid assembly by placing back on dust bin with marks on the lid aligned as shown under **Open (For Emptying)** on the back of the dust bin.

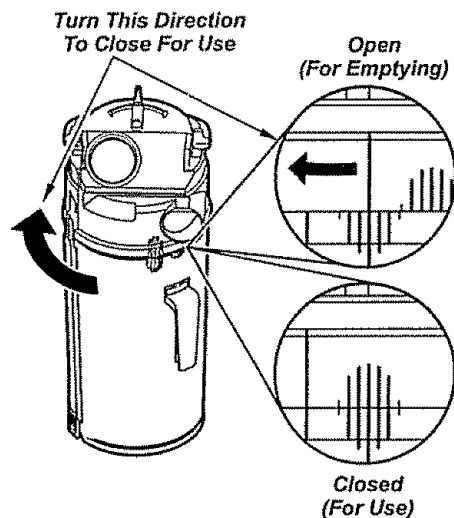

Rotate clockwise while pressing downward so marks align as shown above **Closed (For Use)**.

Insert dust bin into vacuum cleaner.

Lower the dust bin handle to lock dust bin in place.

A noticeable "click" should be heard.

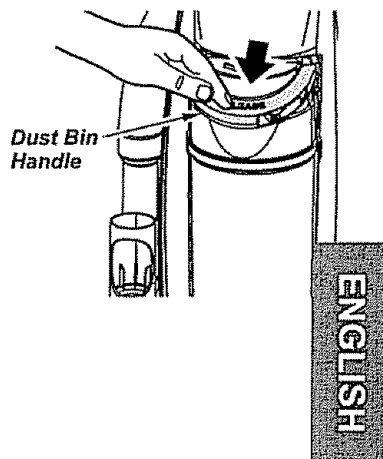

## EXHAUST FILTER REPLACEMENT

The HEPA exhaust filter must be replaced when dirty. It should be replaced regularly depending on use conditions.

The filter **CANNOT** be washed as it will lose its dust trapping ability.

**Note:** See **PARTS AND FEATURES** for the exhaust filter number.

Remove exhaust filter cover by pressing the release tab on the cover and rotating out from vacuum cleaner.

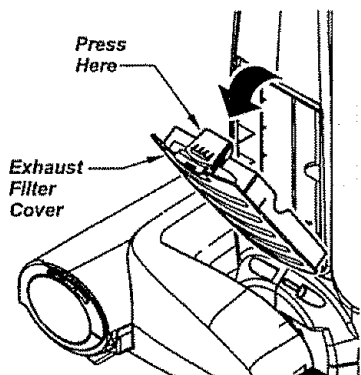

Remove the filter cartridge from cover.

Place new filter cartridge into cover making sure that airflow arrow on side of cartridge points into cover.

Place the foam seal of the filter should be placed against the vacuum cleaner body.

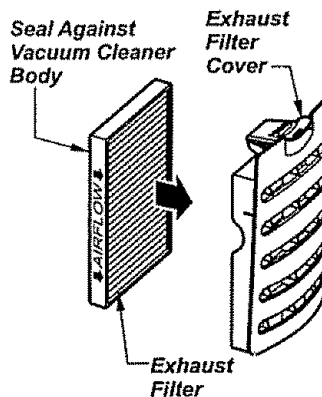

Replace the exhaust filter cover by placing bottom tabs in slots and rotating in until cover snaps into place.

## TO REPLACE LIGHT BULB

### WARNING

**Electrical Shock Or Personal Injury Hazard**

Disconnect electrical supply before performing maintenance to the vacuum cleaner. Failure to do so could result in electrical shock or personal injury from the vacuum cleaner suddenly starting.

### TO REMOVE LIGHT BULB

1. Disconnect power cord from electrical outlet.

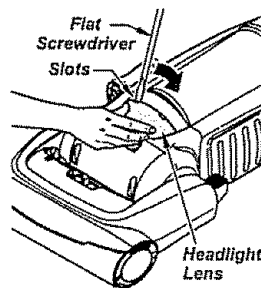

2. Press handle release pedal and lay vacuum cleaner back.

3. Pry light lens out at slots as shown on both sides. Rotate lens up and lift off.

### CAUTION

Do not use a bulb rated over 9W (13V). During extended use, heat from the bulb could overheat surrounding plastic parts.

4. Remove the light bulb by pulling straight out.

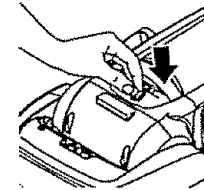
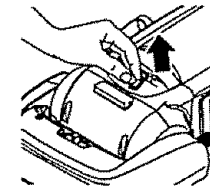

5. Carefully insert new light bulb fully into slot.

Note: See PARTS AND FEATURES for bulb number.

### CAUTION

Do not plug in or turn on until the vacuum cleaner is completely reassembled.

6. To replace light lens, place tab at front of lens into slot. Rotate lens down and firmly snap into place.

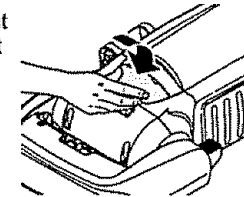



## TROUBLESHOOTING

Review this table to find do-it-yourself solutions for minor performance problems. Any service needed, other than maintenance described in this Owner's Manual, should be performed by a Sears or other qualified service agent.



### WARNING:

Disconnect electrical supply before performing maintenance to the vacuum cleaner. Failure to do so could result in electrical shock or personal injury.

PROBLEM	POSSIBLE CAUSE	POSSIBLE SOLUTION
Vacuum cleaner won't run.	<ol style="list-style-type: none"> <li>1. Unplugged at wall outlet</li> <li>2. Tripped circuit breaker/blown fuse at household service panel</li> <li>3. Thermal protector tripped</li> <li>4. Defective wall outlet</li> <li>5. Handle screw not tight</li> </ol>	<ol style="list-style-type: none"> <li>1. Plug in firmly, select the desired setting on the touch control.</li> <li>2. Reset circuit breaker or replace fuse</li> <li>3. Allow vacuum cleaner to cool, then reset thermal protector</li> <li>4. Check with a good appliance/lamp. have properly serviced</li> <li>5. Tighten screw</li> </ol>
Poor job of dirt pick-up.	<ol style="list-style-type: none"> <li>1. Full or clogged dust bin</li> <li>2. Wrong pile height setting</li> <li>3. Worn agitator</li> <li>4. Clogged nozzle</li> <li>5. Clogged hose</li> <li>6. Hole in hose</li> <li>7. Hose not inserted fully.</li> <li>8. Motor protection system activated (change of sound)</li> <li>9. Dirty filters.</li> </ol>	<ol style="list-style-type: none"> <li>1. Empty dust bin</li> <li>2. Adjust setting</li> <li>3. Take to your nearest Sears Service Center.</li> <li>4. Check for clogs</li> <li>5. Check for clogs</li> <li>6. Take to your nearest Sears Service Center.</li> <li>7. Insert hose fully.</li> <li>8. Check for clogs</li> <li>9. Change filters.</li> </ol>
Vacuum Cleaner picks up moveable rugs or pushes too hard.	<ol style="list-style-type: none"> <li>1. Wrong pile height setting</li> </ol>	<ol style="list-style-type: none"> <li>1. Adjust setting</li> </ol>
Light won't work.	<ol style="list-style-type: none"> <li>1. Burned out light bulb.</li> </ol>	<ol style="list-style-type: none"> <li>1. Change light bulb.</li> </ol>
Agitator does not turn.	<ol style="list-style-type: none"> <li>1. Handle in full upright position.</li> <li>2. Agitator Overload tripped.</li> <li>3. Thermal protector tripped</li> </ol>	<ol style="list-style-type: none"> <li>1. Move handle from upright position</li> <li>2. Reset Agitator Overload</li> <li>3. Allow vacuum cleaner to cool. then reset thermal protector.</li> </ol>
Airflow restricted with attachment use. Sound changes.	<ol style="list-style-type: none"> <li>1. Attachment use restricts air flow.</li> <li>2. New carpet fuzz clogged air path</li> </ol>	<ol style="list-style-type: none"> <li>1. Check attachments for fuzz, lint, pet hair or other debris</li> <li>2. Check for clogs and clean hose.</li> </ol>
Difficulty adjusting pile height setting	<ol style="list-style-type: none"> <li>1. Vacuum cleaner not in proper upright position.</li> </ol>	<ol style="list-style-type: none"> <li>1. Place vacuum cleaner in the locked upright position, tilt the vacuum cleaner back slightly and adjust pile height.</li> </ol>
Dirt Sensor, will not work	<ol style="list-style-type: none"> <li>1. Dirty optic cells.</li> </ol>	<ol style="list-style-type: none"> <li>1. Clean optic cells</li> </ol>

# Get it fixed, at your home or ours!

## Your Home

For repair - **in your home** - of **all** major brand appliances, lawn and garden equipment, or heating and cooling systems, **no matter who made it, no matter who sold it!**

For the replacement parts, accessories and owner's manuals that you need to do-it-yourself.

For Sears professional installation of home appliances and items like garage door openers and water heaters.

**1-800-4-MY-HOME<sup>®</sup>** Anytime, day or night  
(1-800-469-4663) (U.S.A. and Canada)

[www.sears.com](http://www.sears.com)

[www.sears.ca](http://www.sears.ca)

## Our Home

For repair of carry-in products like vacuums, lawn equipment, and electronics, call or go on-line for the nearest **Sears Parts and Repair Center.**

**1-800-488-1222** Anytime, day or night (U.S.A. only)

[www.sears.com](http://www.sears.com)

To purchase a protection agreement (U.S.A.) or maintenance agreement (Canada) on a product serviced by Sears:

**1-800-827-6655** (U.S.A. )

**1-800-361-6665** (Canada )

Para pedir servicio de reparación a domicilio, y para ordenar piezas:

**1-888-SU-HOGAR<sup>®</sup>**  
(1-888-784-6427)

Au Canada pour service en français:

**1-800-LE-FOYER<sup>MC</sup>**  
(1-800-533-6937)  
[www.sears.ca](http://www.sears.ca)



© Sears, Roebuck and Co.

® Registered Trademark / <sup>TM</sup> Trademark / <sup>SM</sup> Service Mark of Sears Brand, LLC

® Marca Registrada / <sup>TM</sup> Marca de Fábrica / <sup>SM</sup> Marca de Servicio de Sears Bra Roebuck ands, LLC

<sup>MC</sup> Marque de commerce / <sup>MD</sup> Marque déposée de Sears Brands, LLC