

Renogy

Pure Sine Wave Inverter with Transfer Switch

12V | 1000W/2000W/3000W

RIV1210PU-126/RIV1220PU-126/RIV1230PU-126

VERSION A2

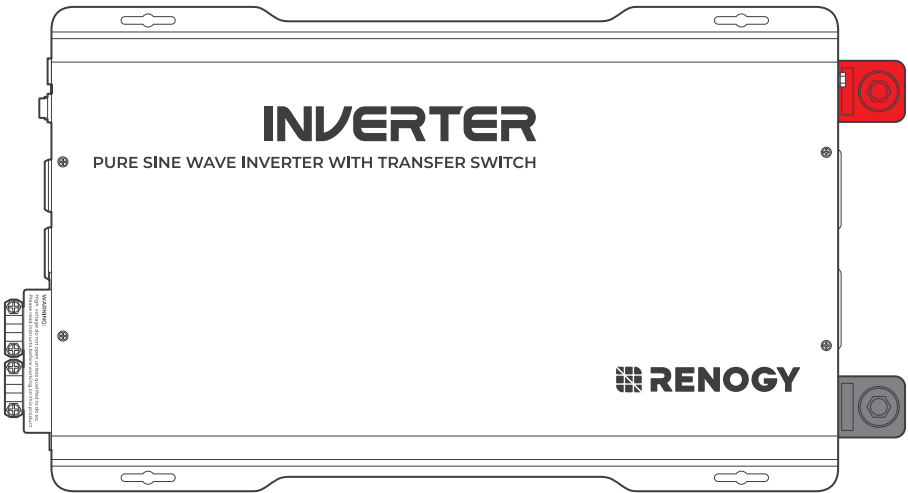

USER MANUAL

Before Getting Started

The user manual provides important operation and maintenance instructions for Renogy 12V 1000W/2000W/3000W Pure Sine Wave Inverter with Transfer Switch (hereinafter referred to as inverter).

Read the user manual carefully before operation and save it for future reference. Failure to observe the instructions or precautions in the user manual can result in electrical shock, serious injury, or death, or can damage the inverter, potentially rendering it inoperable.

- Renogy ensures the accuracy, sufficiency, and the applicability of information in the user manual at the time of printing due to continual product improvements that may occur.
- Renogy assumes no responsibility or liability for personal and property losses, whether directly and indirectly, caused by the user's failure to install and use the product in compliance with the user manual.
- Renogy is not responsible or liable for any failure, damage, or injury resulting from repair attempts by unqualified personnel, improper installation, or inappropriate operation.
- The illustrations in the user manual are for demonstration purposes only. Details may appear slightly different depending on product revision and market region.
- Renogy reserves the right to change the information in the user manual without notice. For the latest user manual, visit [renogy.com](https://www.renogy.com).

Disclaimer

Renogy 12V 1000W/2000W/3000W Pure Sine Wave Inverter with Transfer Switch User Manual © 2023 Renogy. All rights reserved.

RENOGY and **RENOGY** are registered trademarks of Renogy.

- All information in the user manual is subject to copyright and other intellectual property rights of Renogy and its licensors. The user manual may not be modified, reproduced, or copied, in whole or in part, without the prior written permissions of Renogy and its licensors.
- The registered trademarks in the user manual are the property of Renogy. The unauthorized use of the trademarks is strictly prohibited.

Online Manual

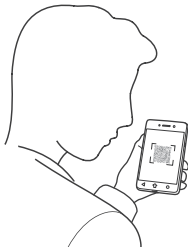

User Manual



Table of Contents

Symbols Used	1
Introduction	1
Key Features	1
SKU	1
What's In the Box?	2
Required Tools & Accessories	2
Get to Know Renogy 12V 1000W Pure Sine Wave Inverter	3
Get to Know Renogy 12V 2000W Pure Sine Wave Inverter	4
Get to Know Renogy 12V 3000W Pure Sine Wave Inverter	5
Part Description	6
How to Properly Install Cable Clamps?	7
System Setup	8
System Wiring	8
Inverter Wiring	9
Size a Battery Bank	10
Step 1. Wear Insulating Gloves	10
Step 2. Plan a Mounting Site	11
Step 3. Grounding	12
Step 4. DC Wiring	12
Step 5. AC Output Wiring	14
Recommended Ground-Fault Circuit Interrupter (GFCL)	14
AC Outlets	14
High Output AC Terminals	14
Step 6. AC Input Wiring (Optional)	15
Power On/Off	16
N-G Bonding Relay	17
Monitor the Inverter	18
Short-Range Monitoring via DC Home App	19
Wireless Long-Range Monitoring	19
LED Overview & Troubleshooting	20
Pure Sine Wave	21
Specifications	22
General Safety Information	23

Renogy Support.....	24
FCC Statement.....	25
FCC Radiation Exposure Statement.....	25

Symbols Used

The following symbols are used throughout the user manual to highlight important information.



WARNING: Indicates a potentially dangerous condition which could result in injury or death.



CAUTION: Indicates a critical procedure for safe and proper installation and operation.



NOTE: Indicates an important step or tip for optimal performance.

Introduction

Renogy 12V 1000W/2000W/3000W Pure Sine Wave Inverter with Transfer Switch is ideal for a wide range of off-grid applications, including vans, semi-trucks, fifth wheels, cabins, and remote locations that require reliable power sources. The inverter converts DC Power stored in batteries into usable AC Power for appliances. Renogy's advanced pure sine wave technology empowers you to run a wide variety of AC appliances without the risk of damaging even your most sensitive equipment.

Key Features

- **Powerful DC-AC Conversion**
Continuous rated output power with a conversion efficiency greater than 92%, and up to 2x surge for start-up loads.
- **Uninterrupted Power Supply (UPS)**
Utilizing the built-in transfer switch, this inverter seamlessly switches to grid power, bypassing the inverter when it's available, thereby directly supplying the load with grid power.
- **Safe for Use**
The inverter provides multiple protection mechanism such as overload, overtemperature, overvoltage, short-circuit, and undervoltage protections as well as an integrated Ground Fault Circuit Interrupter (GFCI).
- **Guaranteed Appliance Protection**
Our pure sine wave technology ensures appliance longevity by delivering a clean sine wave that's comparable to or even better than grid power. Say goodbye to annoying buzzing sounds and enjoy the smooth operation of all your devices.
- **Easy to Use**
Offers a built-in 5V/2.1A USB port, AC Outlets, Hardwired AC Output Terminal Block, and a Wired Remote Port.
- **Dependable Quality**
The inverter is UL certified to 458, CSA 22.2 No. 107.1-01, and FCC Part 15 Class B standards, ensuring reliability and safety for all users.

SKU

Renogy 12V 1000W Pure Sine Wave Inverter with Transfer Switch	RIV1210PU-126
Renogy 12V 2000W Pure Sine Wave Inverter with Transfer Switch	RIV1220PU-126
Renogy 12V 3000W Pure Sine Wave Inverter with Transfer Switch	RIV1230PU-126

What's In the Box?

Renogy 12V 1000W/2000W/3000W
Pure Sine Wave Inverter
with Transfer Switch × 1

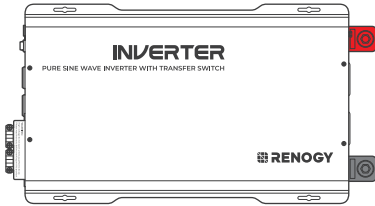

User Manual × 1



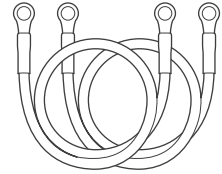

Wired Remote
Control × 1



Cables (3ft) × 2
(only 1000W/2000W inverter)



RJ12 Ethernet Cable (5m) × 1

-  Make sure that all accessories are complete and free of any signs of damage.
-  The accessories and product manual listed are crucial for the installation, excluding warranty information and any additional items. Please note that the package contents may vary depending on the specific product model.
-  The 1000W inverter comes with 4 AWG Cables. The 2000W inverter comes with 1/0 AWG Cables. The 3000W inverter does not include cables, so you will need to prepare them yourself. We recommend using 3/8in Lugs (M12 Ring Terminals) and 2/0 AWG Cables.

Required Tools & Accessories

Choose proper mounting screws specific to your installation site. This manual takes self-tapping screws for wooden walls as an example.



Phillips Screwdriver (#1)

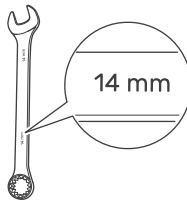

Wrench (9/16 in)

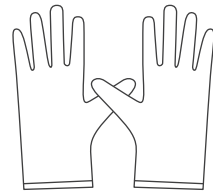

Insulating Gloves



Slotted Screwdriver (1 mm)



Wire stripper

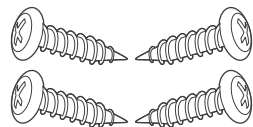

Self-tapping Screws (ST4 or ST6) × 4

-  Prior to installing and configuring the inverter, prepare the recommended tools, components, and accessories.

Get to Know Renogy 12V 1000W Pure Sine Wave Inverter

AC Side View

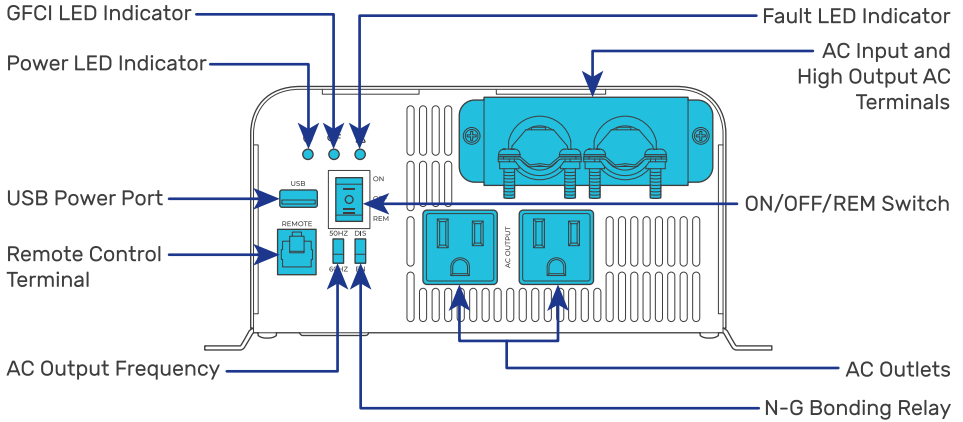

DC Side View

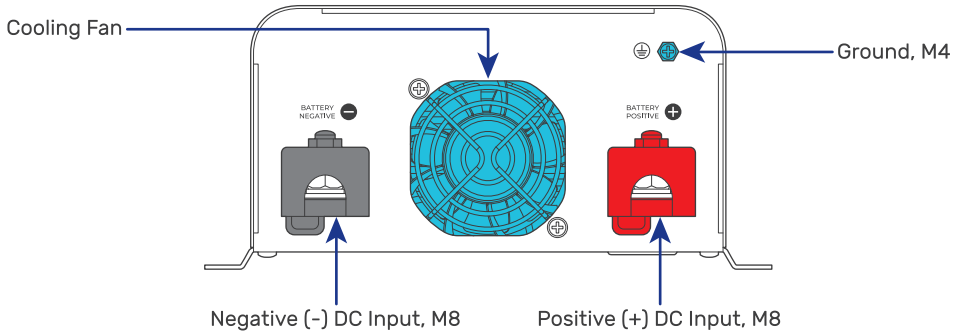

Dimensions

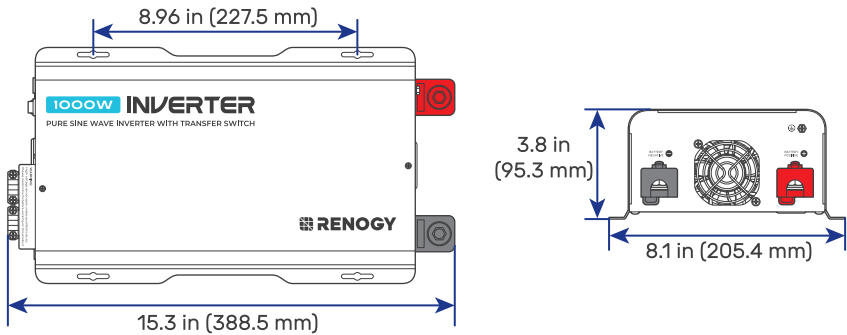

i Dimension tolerance: ± 0.2 in (0.5 mm)

Get to Know Renogy 12V 2000W Pure Sine Wave Inverter

AC Side View

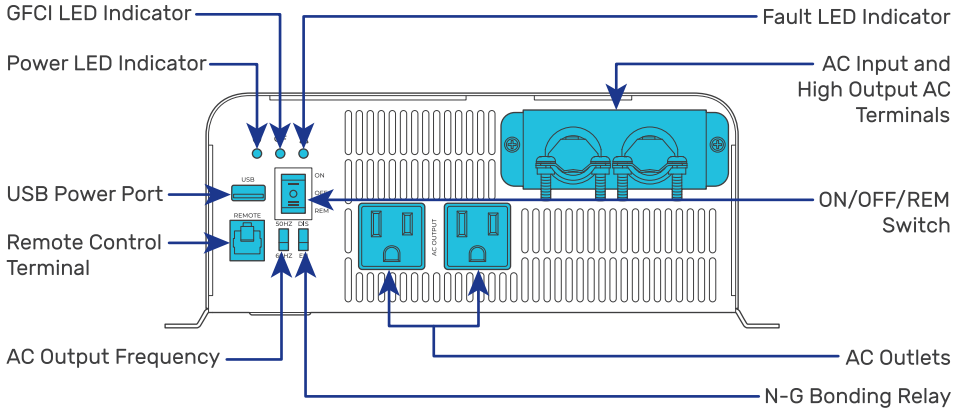

DC Side View

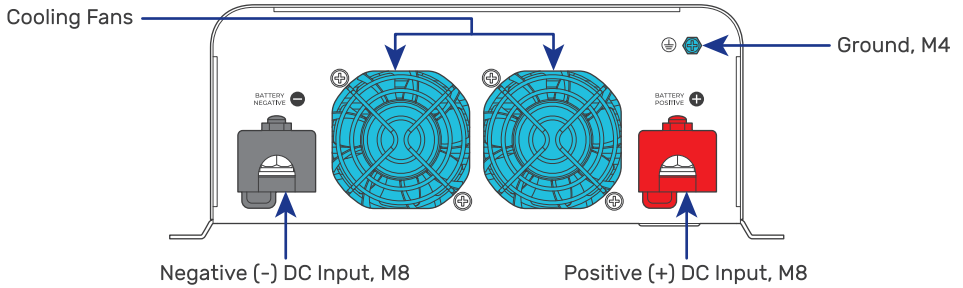

Dimensions

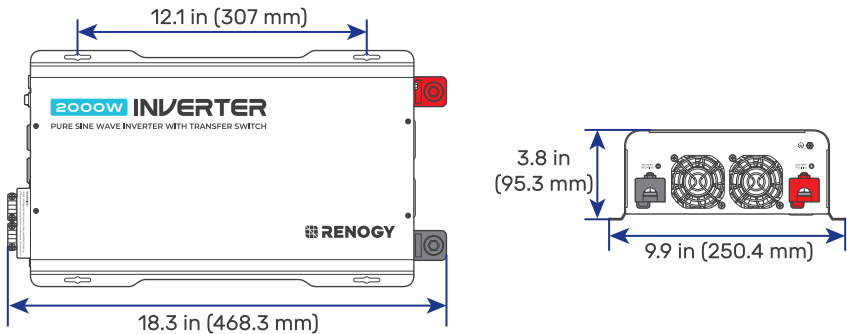

i Dimension tolerance: ± 0.2 in (0.5 mm)

Get to Know Renogy 12V 3000W Pure Sine Wave Inverter

AC Side View

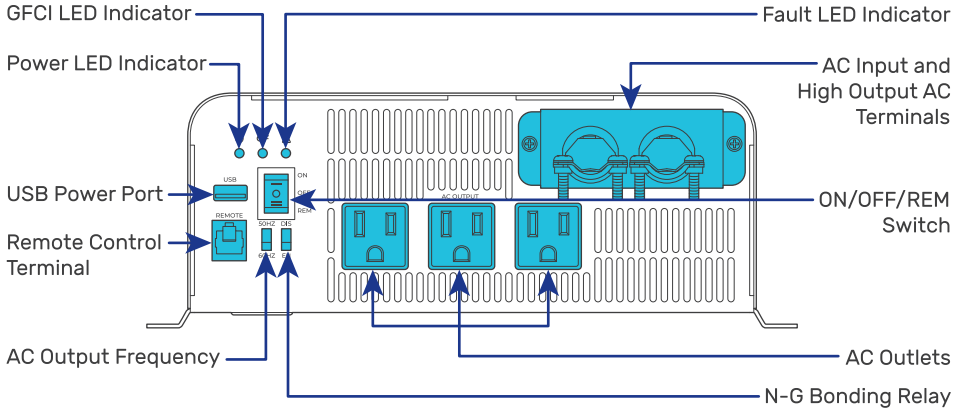

DC Side View

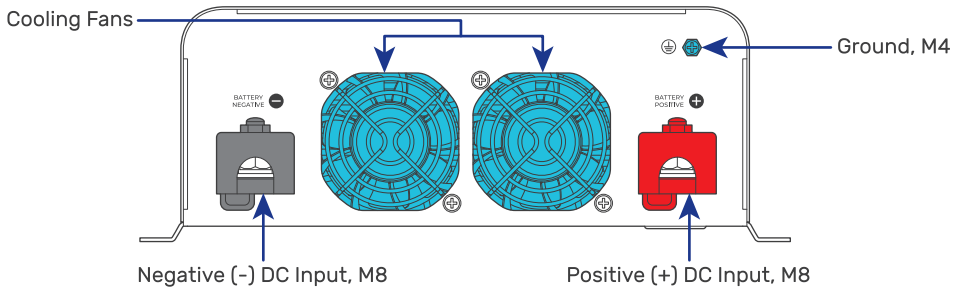



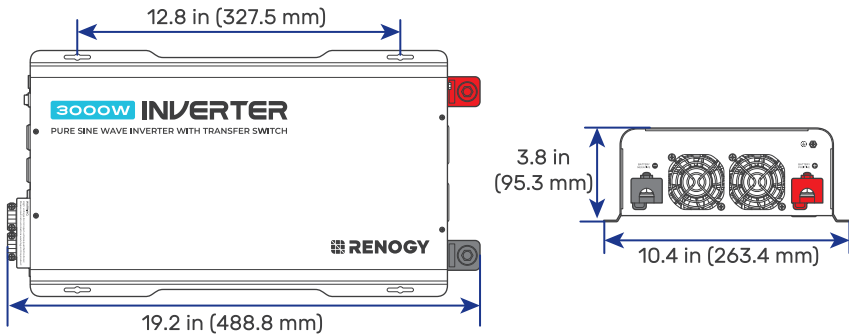





Dimensions

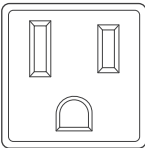

i Dimension tolerance: ± 0.2 in (0.5 mm)

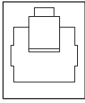
Part Description

Part	Description
 <p>ON OFF REM</p>	<p>ON/OFF/REM Switch Turns the inverter ON, OFF, or REMOTE.</p>
	<p>Power LED Indicator Indicates the operational status of the inverter.</p>
<p>GF</p> 	<p>GFCI LED Indicator Indicates that the ground fault circuit has been interrupted. In such case, restart the inverter.</p>
	<p>Fault LED Indicator Indicates that the inverter shuts down due to overheating, overload, undervoltage, or overvoltage. Solution: Immediately turn off all AC appliances. Allow the inverter to cool before continuing. Make sure that the ventilation vents are not blocked. Ensure all cables are of proper sizes and lengths.</p>
	<p>AC Outlets 120V AC, 50/60 Hz.</p> <ul style="list-style-type: none"> ● Up to 10A x 2 for Renogy 12V 1000W Pure Sine Wave Inverter ● Up to 16A x 2 for Renogy 12V 2000W Pure Sine Wave Inverter ● Up to 16A x 3 for Renogy 12V 3000W Pure Sine Wave Inverter
<p>USB</p> 	<p>USB Power Port Supplies 5V/2.1A for charging tablets, smartphones, and other small appliances.</p>
<p>REMOTE</p> 	<p>Remote Control Terminal Connects to the Wired Remote Control.</p>
<p>50HZ</p>  <p>60HZ</p>	<p>AC Output Frequency Configure the AC output frequency of the inverter in accordance with the frequency of the connected AC loads.</p>
<p>DIS</p>  <p>EN</p>	<p>N-G Bonding Relay The inverter is equipped with a Neutral to Ground (N-G) bonding relay that ensures that either the neutral in or out contact of the RV is always grounded. You can manually enable or disable the N-G Bonding Relay as needed.</p>

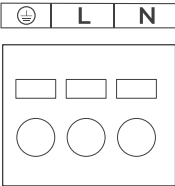
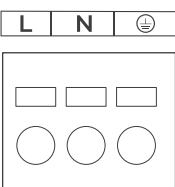
 <p style="text-align: center;">AC OUTPUT</p>	<p>High Output AC Terminals</p> <p>Distributed wiring with multiple AC outlets. Remove the two screws on the protective cover to access the terminals. Terminal layout (facing the front panel):</p> <ul style="list-style-type: none"> ● Left: Ground (G) ● Middle: Live (L) ● Right: Neutral (N)
 <p style="text-align: center;">AC INPUT</p>	<p>AC Input Terminals</p> <p>When the inverter is connected to single-phase 120V power systems through the AC Input Terminals, the grid power can directly supply power to the load through bypass. Remove the two screws on the protective cover to access the terminals. Terminal layout (facing the front panel):</p> <ul style="list-style-type: none"> ● Left: Live (L) ● Middle: Neutral (N) ● Right: Ground (G)

How to Properly Install Cable Clamps?

The AC Input Terminals and AC Output Terminals are equipped with cable clamps to ensure that the wiring connections remain secure and do not come loose due to vibrations.

Step 1: Remove the two screws on the protective cover to access the terminals.

Step 2: Loosen the screws on a cable clamp with a Phillips Screwdriver.

Step 3: Lift the clamp, and run the cables through the clamp.

Step 4: Secure the clamp by fastening the screws.

Step 5: Install the protective cover and secure it using two screws.

System Setup

System Wiring

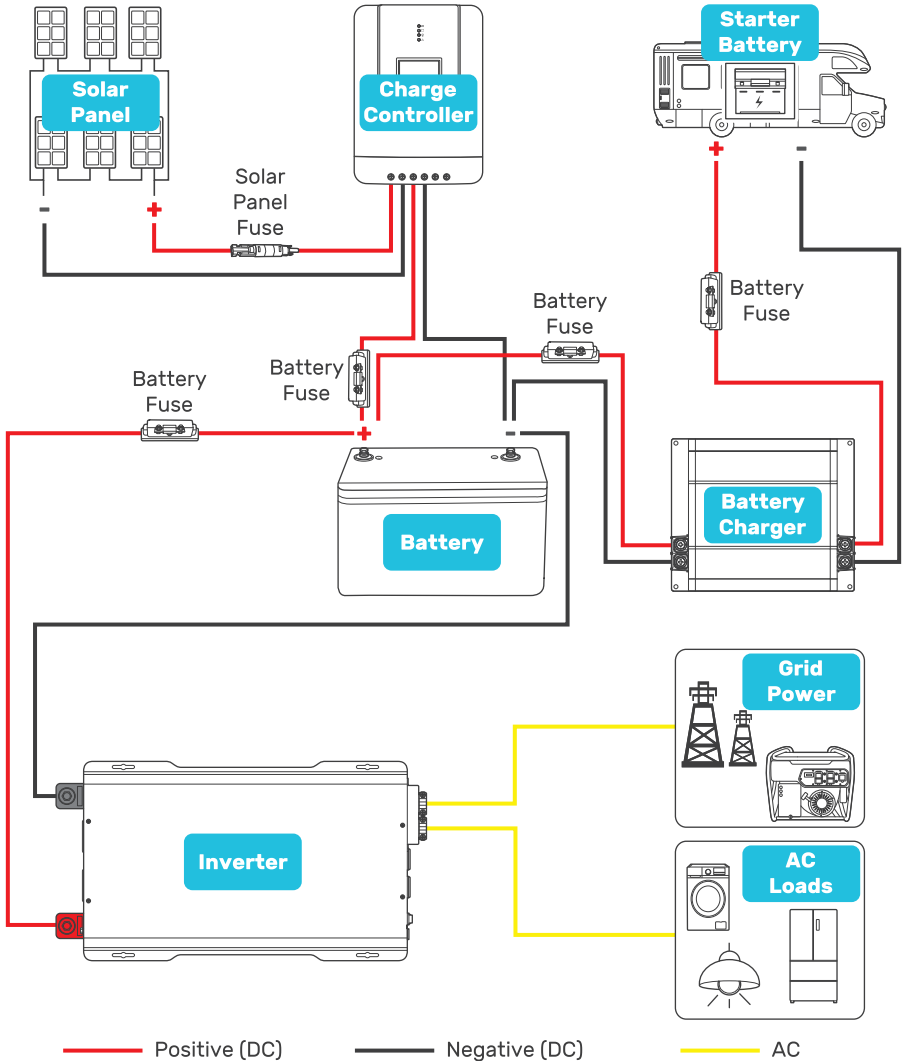

i The wiring diagram only shows the key components in a typical DC-coupled off-grid energy storage system for the illustrative purpose. The wiring might be different depending on the system configuration. Additional safety devices, including disconnect switches, emergency stops, and rapid shutdown devices, might be required. Wire the system in accordance with the regulations at the installation site.

i The grid supplies the connected loads only. It does not charge the battery.

Inverter Wiring

The wiring diagram provided in this section is tailored for a 1000W inverter model. Similar wiring rules apply to other models.

AC Side View

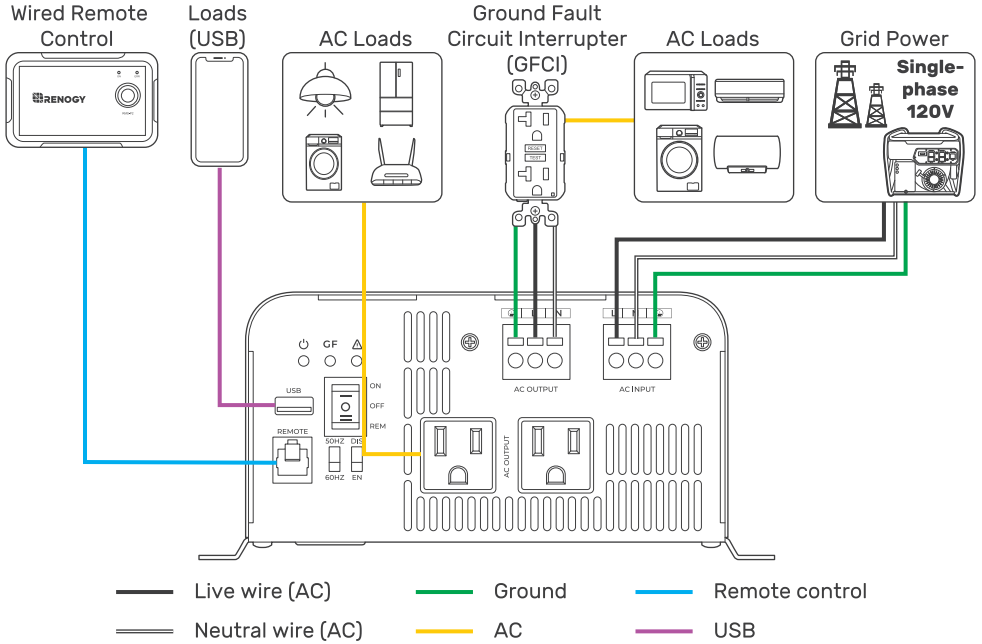

DC Side View

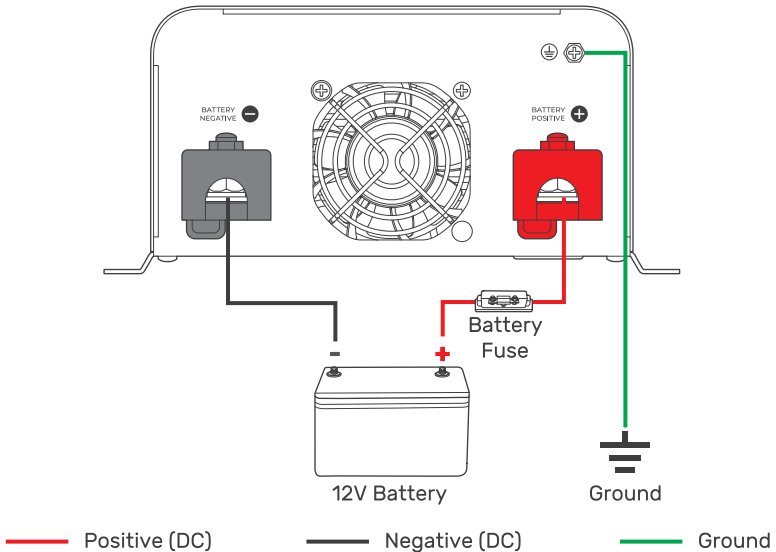

Size a Battery Bank

Battery types and capacity relate to the overall inverter performance. To size a proper battery bank, you need to identify the loads that you will be utilizing, as well as an estimate duration (hours/day) you will be using the load. The inverter is only compatible with 12V battery banks, and oversizing should be considered due to efficiency losses.

1. Determine Your Watts (Amps x Volts)
Every electronic device will have a sticker or plate identifying the watts directly (W) or will show you the voltage value (V) as well as amperage (A) which need to be multiplied to get Watts. The formula is below:
Watts (W) = Volts (V) x Amps (A)
Example: Fan Watts = 120V * 0.4A = 48Watts
2. Estimate Load Run-Time in Watt-Hours (Wh)
Estimate how many hours per day you will be using the load and multiply this by your Watts per load.
Example: Fan Watts x 12 hours = Watt-Hour (Wh)
48W x 12h = 576Wh
3. Determine Battery Capacity in Amp-Hour (Ah)
Divide your Load Run Watt-Hour result by the battery voltage.
Load Run-Time (Wh)/Battery Voltage (V) = Amp-Hour (Ah)
Use 12V, supported voltage of the inverter as a reference.
576Wh/12V = 48 Ah
4. Oversize the Battery
The calculated Amp-Hour value represents the minimum size battery capacity to run your load for your intended time. Note that this assumes 100% use of a battery, which is not recommended. Assuming 50% depth of discharge, you want to multiply this value by 2 and you also want to multiply by 1.25 to account for some efficiency losses.
Formula:
48Ah x Oversize x Efficiency Losses = Recommended Amp-Hour
48 x 2 x 1.25 ≈ 115Ah
Therefore, a 115Ah battery bank, or close, will be able to support a 12-hour run time while also prolonging battery life for the best system size possible.

i Actual battery quantities vary by battery capacity and rates of discharge.

Step 1. Wear Insulating Gloves

This manual utilizes the 1000W Inverter as a reference for its illustrations. The wiring techniques remain consistent across all inverter models, though there may be variations in terminal positions.

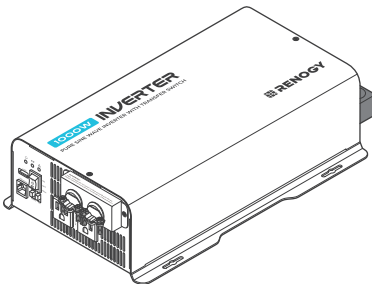

Insulating
Gloves

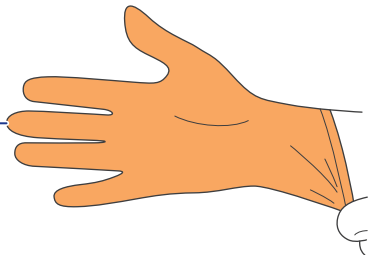

Step 2. Plan a Mounting Site

Follow the guidelines below:

- **Cool, dry, and well-ventilated area**

The inverter must be installed in a site where the fans are not blocked or where they are not hit directly by the sun. The site should be free of any kind of moisture with a clearance of at least 10 inches around the inverter for adequate ventilation.

- **Protection against fire hazard**

The inverter should be away from any flammable material, liquids, or any other combustible material.

- **Close proximity to battery bank**

Put the inverter close to batteries banks to prevent excessive voltage drop. Choose a proper sized wire going from the battery bank to the inverter.

- **Limiting electromagnetic interference (EMI)**

Ensure the inverter is firmly grounded to a building or vehicle. Alternatively, it can be earth grounded. Keep the inverter away from EMI receptors such as TVs, radios, and other audio/visual electronics to prevent damage/interference.

- **Secure mounting**

The inverter should be stand-alone or mounted by using the outlying terminals with ST4 and ST6 screws on the inverter.

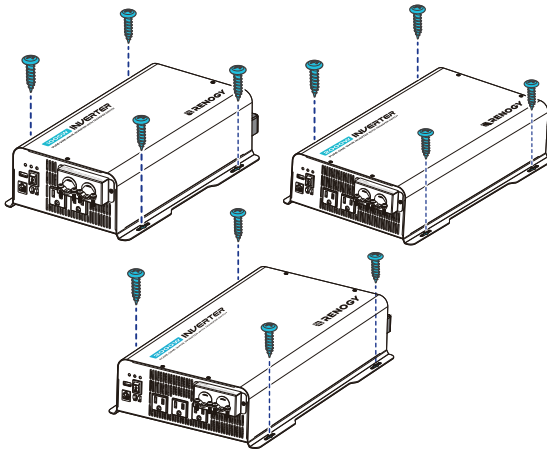

-4°F to 113°F / -20°C to 45°C

- ⚠ Do not over-torque or overtighten the terminals. This could potentially damage the unit.
- ⚠ Refer to the technical specifications for maximum wire sizes on the controller and for the maximum amperage going through wires.
- ⚠ Ensure the inverter is in the OFF position before connecting to anything.
- ⚠ Do not install the inverter in the same compartment as the battery bank because it could serve as a potential fire hazard.
- ⚠ Never mount the inverter vertically on a vertical surface since it would present a hazard for the fan opening, undermining cooling the inverter.

■ How to Properly Install Cable Clamps?

The AC Output Port with cable clamps to ensure that the wiring connections remain secure and do not come loose due to vibrations.

Step 1: Loosen the screws on a cable clamp with a Phillips Screwdriver.

Step 2: Lift the clamp, and run the cables through the clamp.

(You will need 1 x 3 prong (10 AWG recommended Black, White, Green) ac cables not provided with this product. Measure the required length for your particular application. for ac output of the inverter.SJT0 and SJT,SJ0 are recommended wire)

Step 3: Secure the clamp by fastening the screws.

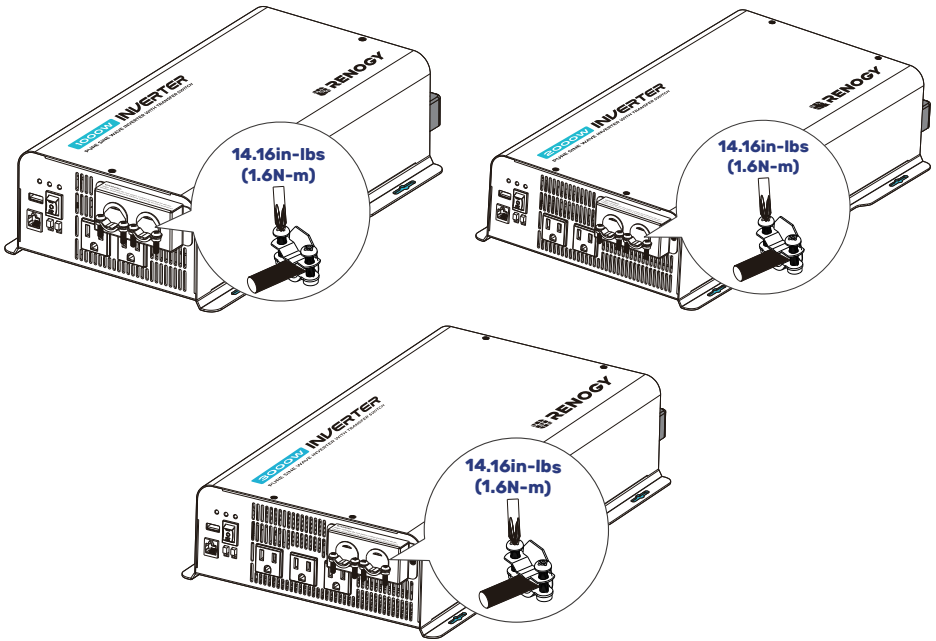

⚠ Do not use the bare wires if there is any visible damage.

⚠ Do not use SP-3, SPT-3 type wire

i The screw torque of a cable clamp is 14.16 in·lbs (1.6 N·m).
Do not over tighten the screws to prevent damage

Step 3. Grounding

Grounding is highly recommended for both when using the inverter in a mobile application, such as an RV, or in a building. If available, the chassis ground lug should be connected to a ground point such as a vehicle chassis or boat grounding system. In fixed locations, connect the ground lug to earth ground. The connections to ground must be tight and against bare metal.

Recommended Components



3/16 in (M4)

Grounding Cable

Model	Recommended Size
1000W Pure Sine Wave Inverter	14 AWG
2000W Pure Sine Wave Inverter	12 AWG
3000W Pure Sine Wave Inverter	10 AWG

i When the GFCI fails to operate normally after grounding the inverter, please refer to "[N-G Bonding Relay](#)" for details.

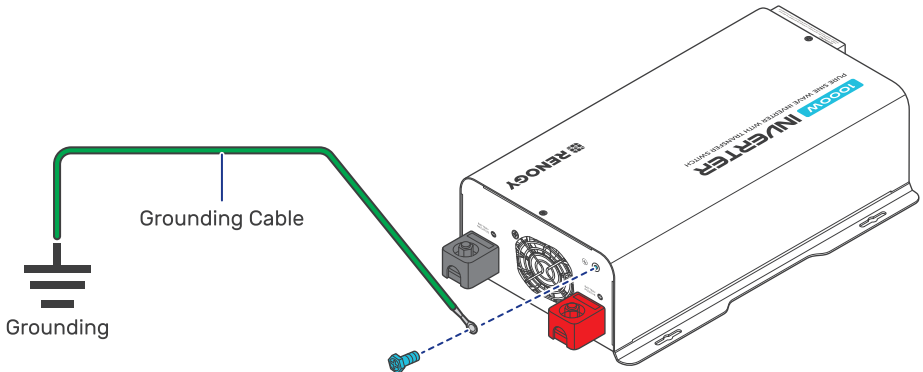

Step 4. DC Wiring

The inverter is suitable for 12V battery bank systems ONLY. Not following the minimum DC requirement will cause irreversible damage to the device.

The input terminals of the inverters are embedded with large capacitors. The input circuit is completed once the terminals are connected to both positive and negative wires. This commences drawing a heavy current momentarily. As a result, there may be a sparking occurring even if the inverter is in the off position. To minimize sparking, it is recommended that you should choose an appropriate sized wire feeding into the inverters and/or install an external fuse leading into the inverter.

⚠ Be careful of the positive and negative poles. Reversing the poles might cause permanent damage to the inverter and will void the warranty.

For your safety, it is recommended that you should use a battery fuse on the positive end.

Model	RIV1210PU-126	RIV1220PU-126	RIV1230PU-126
Continuous Output Power	1000W	2000W	3000W
Battery Fuse	150A	250A	400A

Step 1: On the AC side, set the ON/OFF Switch to the OFF position.

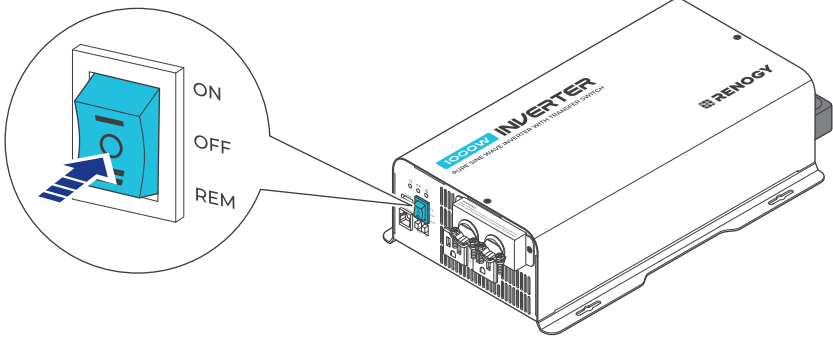

Step 2: On the DC side, remove the protection caps.

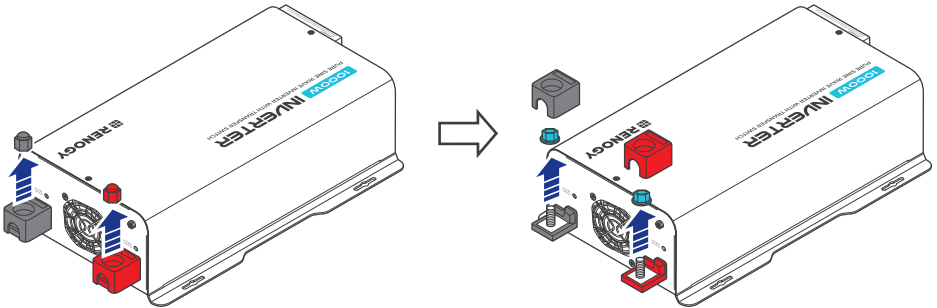

Step 3: Unscrew Positive and Negative DC Input Terminals, connect a battery bank to the terminals, and tight the terminal screws. Torque: 14(\pm 0.5) N·m

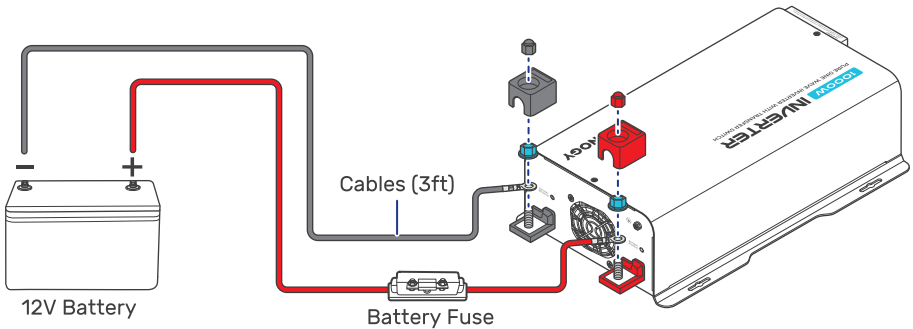

Step 5. AC Output Wiring

Recommended Ground-Fault Circuit Interrupter (GFCI)

A ground-fault circuit interrupter, or GFCI, is a device that helps protect people from electric shocks by de-energizing a circuit or portion of a circuit within an established period of time when a current to ground exceeds some predetermined value that is less than that required to operate the overcurrent device (circuit breaker or fuse) of the supply circuit. GFCIs are usually required in wet or damp locations.

While the inverter is equipped with a GFCI, an external GFCI is strongly recommended to elevate system safety.

The following table lists GFCIs that meet the specifications and will function properly when they are connected to the AC Outlets of the inverter.

Tested GFCI Models	
Manufacturer	Model Number
Leviton	GFNT2
Hubbell	GFP1305
Hubbell	GF15WLA

⚠ Risk of electrical shock. Use only ground-fault circuit interrupters [receptacle(s) or circuit breaker(s)] compatible with your inverter.

⚠ GFCIs shall be installed in a recreational vehicle's wiring system to protect all branch circuits.

AC Outlets

You can plug your AC loads directly into the AC Outlets on the inverter's AC side.

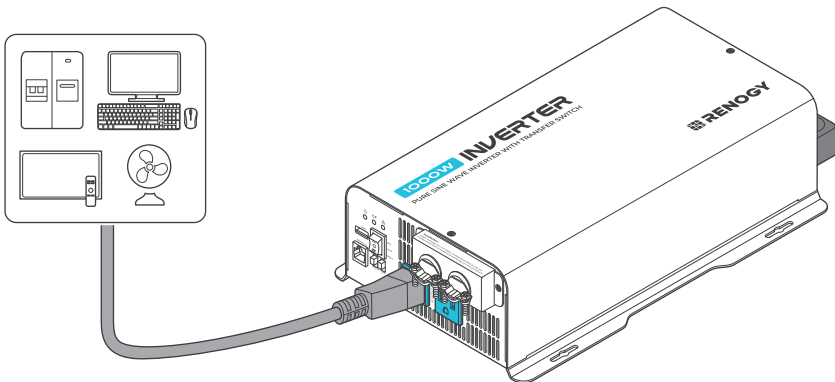

High Output AC Terminals

Additionally, you have the option to establish a permanent connection from the AC output by linking it through the High Output AC Terminals to a GFCI, a load sub-panel, or supplementary AC outlets that receive power from the inverter.

From left to right, the terminal block indicates: Ground (G), Live/Hot (L), and Neutral (N).

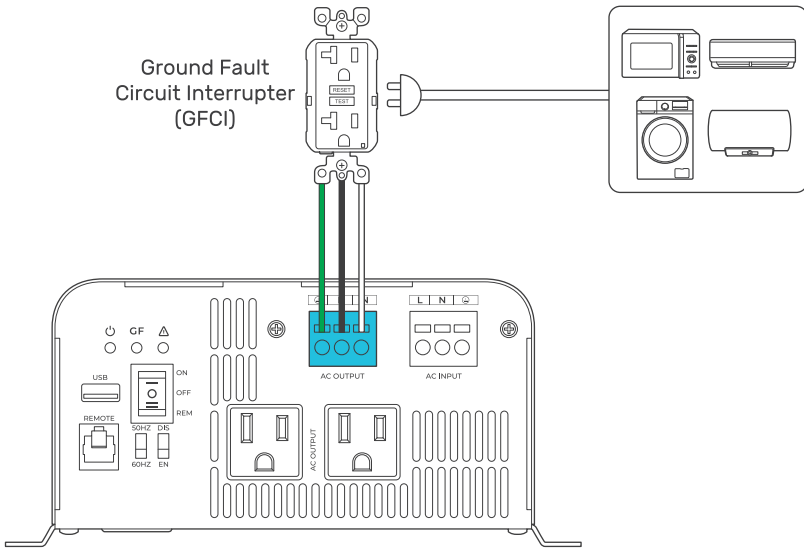

i For details on how to connect loads and the inverter to the GFCI, read the user manual of the specific GFCI.

Step 6. AC Input Wiring (Optional)

Utilizing the built-in transfer switch, this inverter seamlessly switches to grid power, bypassing the inverter when it's available, thereby directly supplying the load with grid power.

From left to right, the terminal block indicates: Live/Hot (L), Neutral (N), and Ground (G).

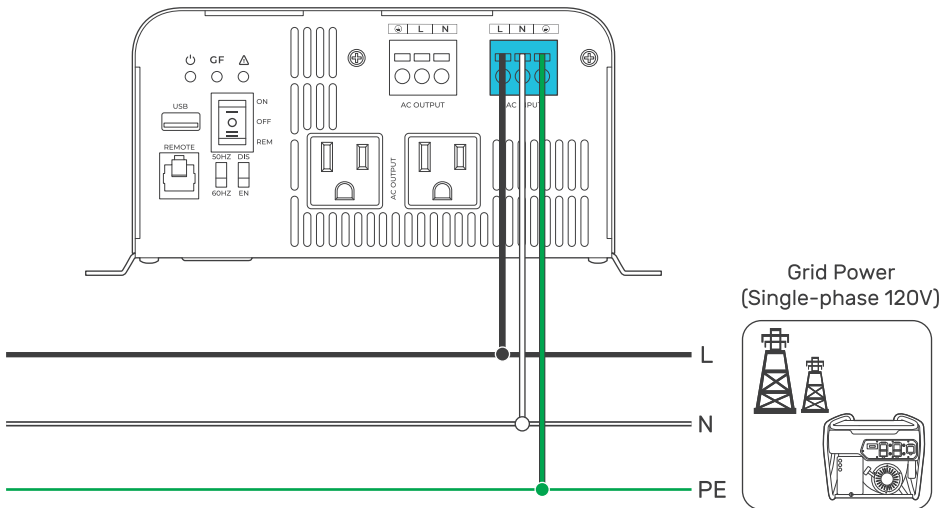

! Risk of electric shock! Ensure the grid or the AC generator is turned off before connecting them to the inverter.

Power On/Off

Operations on Inverter

After proper battery and AC load connections, you can operate the inverter.

1. On the AC side, rock the ON/OFF Switch to the ON position.
2. The inverter is operating normally.

When finishing using the inverter, power off the AC loads first, and then rock the ON/OFF Switch to the OFF position.

- ⚠ When the inverter turns on, it is normal to see the fans run for a second and hear a beep.
- ⚠ Avoid powering on the inverter with the load (electronic devices) already switched on. This may trigger an overload since some electronic devices have an initial high power surge to start.
- ⚠ When switching off the inverter, turn off the electronic devices first. Although the inverter is off, the terminal capacitors will still have a charge, so the DC and AC terminals must be disconnected if altering the circuitry.

Wired Remote Control

The Wired Remote Control gives you the opportunity to power on/off the inverter from a distance (approximately 16.4 ft / 5 m).

Note that the inverter ON/OFF switch should be in the REM position.

Step 1: Connect the Wired Remote Control to the inverter via the Remote Control Connector.

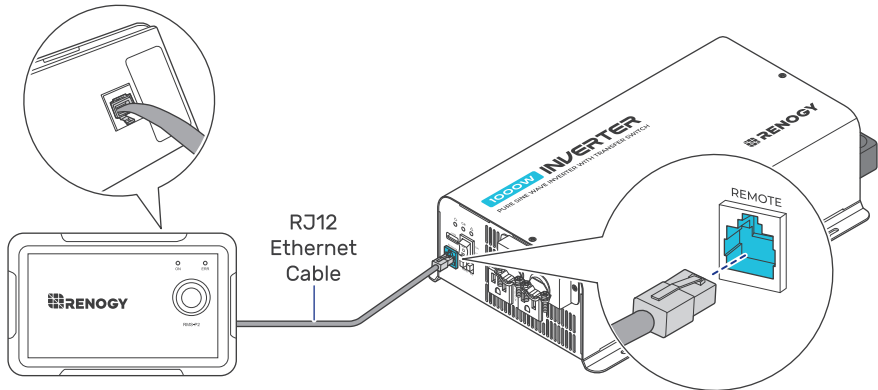

Step 2: Rock the ON/OFF Switch to the REM position, and you can power on/off the inverter via the Wired Remote Control.

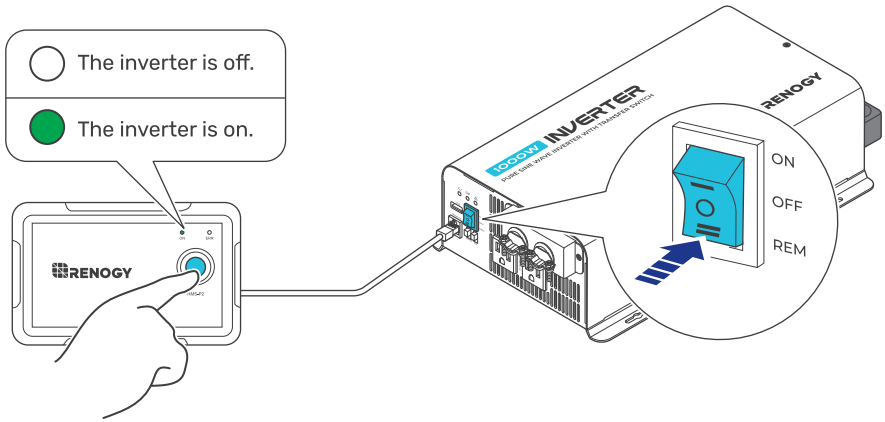

N-G Bonding Relay

The inverter is equipped with a Neutral to Ground (N-G) bonding relay that ensures that either the neutral in or out contact of the RV is always grounded.

This helps prevent electrical shock caused by contact between the neutral contacts of the RV and external AC power sources.

By default, the Neutral to Ground bonding relay is enabled when the inverter is shipped from the factory.

- When there is AC input current, the N-G bonding relay automatically opens the neutral-to-ground connection as shown in the figure below, and the system connects to the grid ground contact.

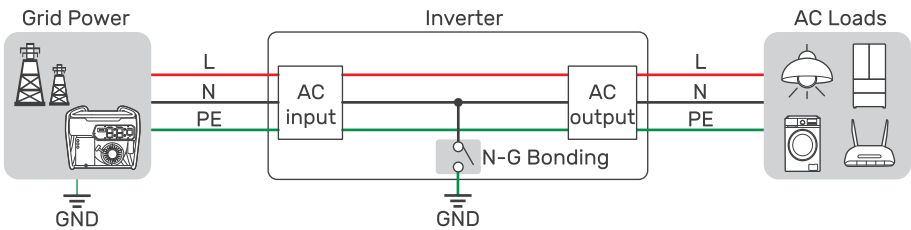

- When there is no AC input current, the N-G bonding relay automatically closes and connects to the ground contact of the inverter. In this case, the inverter supplies loads with the connected battery.

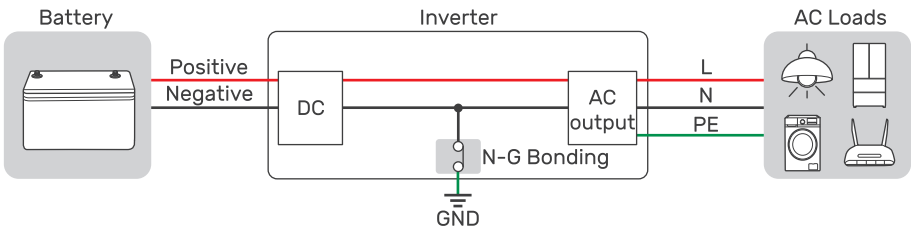

i In scenarios where the N-G bonding relay is disabled, the N-G bonding relay connects to the ground contact of the inverter only.

You have the option to manually enable or disable the N-G Bonding Relay.

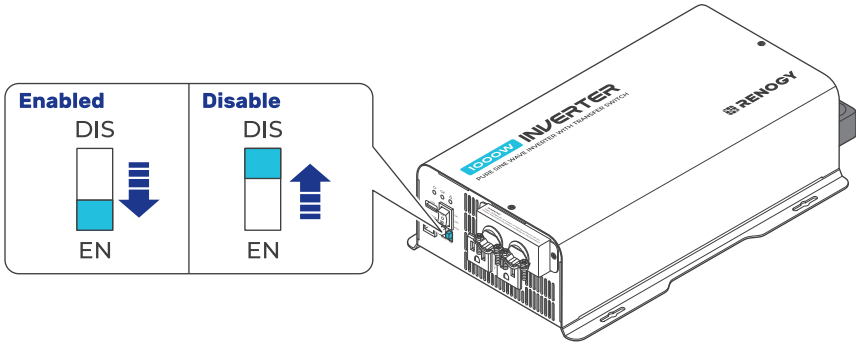

i The N-G bonding relay must be enabled when the battery supplies the connected loads because the GFCI will be unavailable if the N-G bonding relay is disabled.

! In scenarios when N-G bonding relay is disabled, the inverter must be grounded.

Monitor the Inverter

Depending on the specific application, the inverter can establish either short-range or long-range communication connections with monitoring devices. These monitoring devices facilitate real-time monitoring, programming, and complete system management, offering comprehensive control and enhanced flexibility.

i The version of the DC Home app might have been updated. Illustrations in the user manual are for reference only. Follow the instructions based on the current app version.

i Make sure that the inverter is properly installed and powered on before it is paired with the DC Home app.

i To ensure optimal system performance, keep the phone within 10 feet (3 m) of the inverter.

Download the DC Home app. Login to the app with your account.



DC Home App

GET IT ON
Google Play

Download on the
App Store

Short-Range Monitoring via DC Home App

If only short-range monitoring is required, connect the inverter to the DC Home app directly through the Bluetooth of your phone.

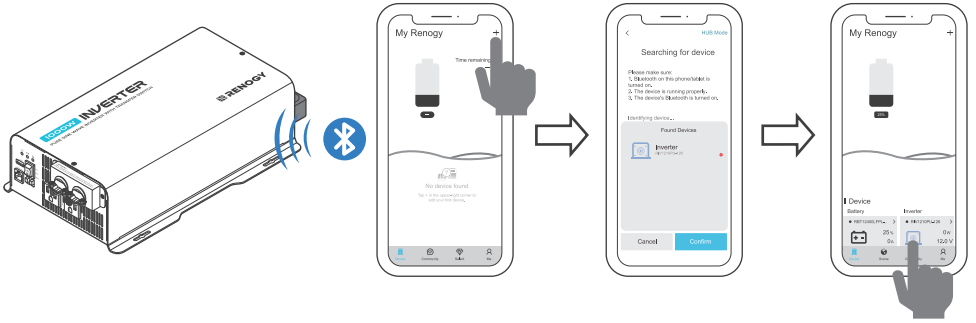

Wireless Long-Range Monitoring

If long-range communication and programming are required, connect the inverter to Renogy ONE (sold separately) through Bluetooth, and the Renogy ONE to the DC Home app through Wi-Fi.

Recommended Components

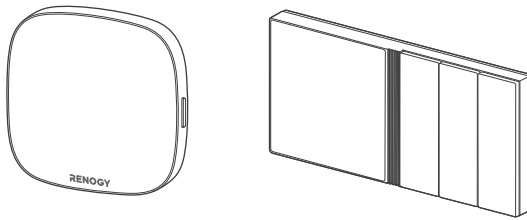





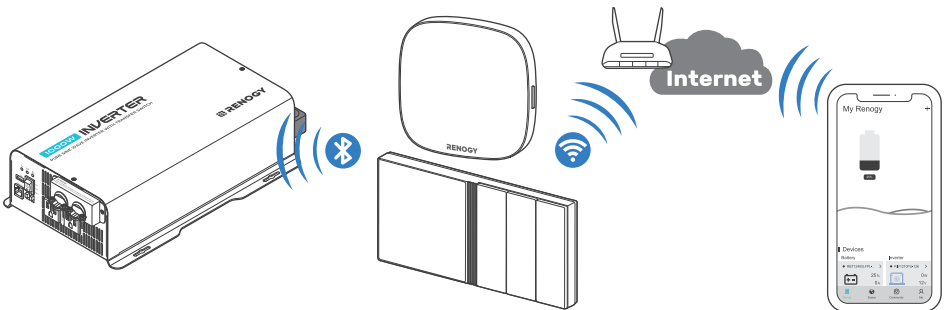



*RENOGY ONE Core or Renogy ONE M1

- Components marked with "*" are available on [renogy.com](https://www.renogy.com).
- For instructions on Renogy ONE, see [Renogy ONE Core User Manual](#) and [Renogy ONE M1 User Manual](#).



LED Overview & Troubleshooting

LED Status	Alarm	Protection & Alarm	Inverter Status
LED in flicker red  	Alarm beeps	Input voltage is below 11V.	Keep input voltage above 11V.
		Input voltage is above 15.5V.	Keep input voltage below 15.5V.
Power LED in solid green  	No sound	Recovery from undervoltage	Normal output from the inverter.
GFCI LED in solid yellow GF 	Long steady beeping sound	GFCI protection	1. No output from the inverter. 2. Disconnect all appliances, and use the ON/OFF/Remote switch to reset the inverter. Attempt to connect various appliances one at a time, observing if the yellow LED on the inverter remains illuminated. If it stays off, this suggests a current leakage issue with one of the appliances. If the LED remains on, kindly reach out to Renogy via renogy.com/contact-us for further assistance.
	No sound and the inverter is off	GFCI tripped	Disconnect appliances, and use the ON/OFF/Remote switch to reset the inverter.
Fault LED in solid red  	Long steady beeping sound	Overtemperature protection	1. No output from the inverter. 2. Allow the inverter to cool down. 3. Check for adequate ventilation. 4. Reduce the load on the inverter.
		Undervoltage shutdown	No output from the inverter. Keep input voltage above 10.5V.
		Short circuit protection	No output from the inverter. After 5s, the inverter automatically restarts. After five times of failed restart, the inverter needs to be restored by manually turning it on.
		Overvoltage protection	No output from the inverter. Keep input voltage below 16V.

LED Status	Alarm	Protection & Alarm	Inverter Status
Fault LED in solid red 	Long steady beeping sound	Overload protection	Automated recovery after 20 seconds (manual restart required if automated recovery fails).

 For further assistance, contact Renogy technical support service at <https://www.renogy.com/contact-us>.

Pure Sine Wave

The inverter outputs a pure sine wave similar to the waveform of the grid power. In a pure sine wave, the voltage rises and falls in a smooth fashion with very low harmonic distortion and cleaner utility-like power.

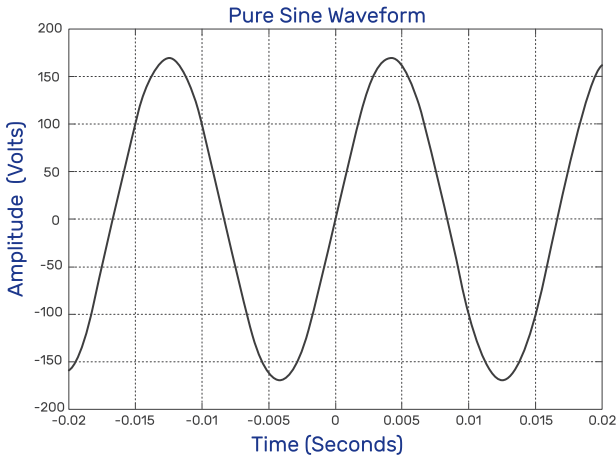

This technology allows the inverter to supply electronic devices that require a high quality waveform with little harmonic distortion. In addition, the technology enables the inverter to be more efficient than traditional ones, allowing you to use less energy to supply more devices. The inverter can provide sufficient, stable power for tools, fans, lights, computers, and other electronics without any interference.

Specifications

General Data			
Model	RIV1210PU-126	RIV1220PU-126	RIV1230PU-126
Output Waveform	Pure Sine Wave		
AC Terminals	2 x AC sockets 1 x AC high-output terminal block	2 x AC sockets 1 x AC high-output terminal block	3 x AC sockets 1 x AC high-output terminal block
DC Terminals	M8 x 25 mm		
Operating Temperature	-4°F to 113°F / -20°C to 45°C		
Storage Temperature	-40°F to 158°F / -40°C to 70°C		
Humidity	Max 95%, non-condensing		
Cooling	Fans		
Dimensions (L x W x H)	15.3 x 8.1 x 3.8 in / 388.5 x 205.4 x 95.3 mm	18.3 x 9.9 x 3.8 in / 468.3 x 250.4 x 95.3 mm	19.2 x 10.4 x 3.8 in / 488.8 x 263.4 x 95.3 mm
Weight	8.2 lb / 3.7 Kg	12.8 lb / 5.8 Kg	14.8lb / 6.7 Kg
Regulatory and Safety Specifications	UL certified to 458 and to CSA 22.2 No. 107.1-01, FCC Prt15 Class B		
Electrical Data			
Continuous Output Power	1000W	2000W	3000W
Continuous Output Current	8.3A AC	16.6A AC	25.0A AC
Total Harmonic Distortion (THD)	< 3%		
Power Factor	1		
Surge Rating (after 2S the overload protection)	2000W (@2s)	4000W (@2s)	6000W (@2s)
Output Voltage	120V AC (±3%)		
Output Frequency	50Hz / 60Hz		
Rated Battery Input Voltage	12V DC		
Battery Input Voltage Range	11.0V to 15.5V DC		
Rated AC Input Voltage Range	90V to 140V AC		
Transfer Switch Rating	10A	20A	30A
Transfer From AC Mains Supply to Battery	20 ms		
Transfer From Battery Supply to AC Mains	20 ms		

Maximum Continuous Battery Output Current	105A	210A	310A
Inverter Efficiency	92%, MAX		
Full Load Efficiency	87%		
Power Consumption	< 12W	< 18W	< 18W
Battery Overvoltage Shutdown	16.0V ($\pm 0.3V$) DC		
Battery Low Voltage Alarm	11.0V ($\pm 0.3V$) DC		
Battery Low Voltage Shutdown	10.5V ($\pm 0.3V$) DC		
Wired Remote Data			
Front Plate Dimensions	2.8 x 4.3 x 1.3 in / 70 x 110 x 31.8 mm		
Wired Length	16.4 ft / 5 m		

General Safety Information

■ WARNING

- Have the inverter installed by a qualified technician in accordance with the local and national electric codes (NEC).
- There are no serviceable parts for this inverter. Do not disassemble or attempt to repair the inverter.
- Ensure all connections going into and from the inverter are tight. There may be sparks when making connections; therefore, there should not be flammable materials or gases near the installation site.
- The inverters are suitable for 12V battery banks ONLY.
- Always ensure the inverter is in OFF position and disconnect all AC and DC devices associated with the inverter.
- Never connect the AC output of the inverter directly to an Electrical Breaker Panel or Load Center which is also fed from the utility power or generator.
- Please confirm the polarity of the devices before connection. A reverse polarity contact can cause injury and damage the device.
- Be careful when touching bare terminals of capacitors as they may retain high lethal voltages even after power is removed.
- Do not let the positive (+) and negative (-) terminals of the battery touch each other. Use only deep-cycle sealed lead-acid, flooded, gel, or lithium batteries.
- Risk of explosion! Never install the inverter in a sealed enclosure with flooded batteries! Do not install in a confined area where battery gases can accumulate.
- Be careful when working with large lead acid batteries. Wear eye protection and have fresh water available in case there is contact with the battery acid.
- Overcharging and excessive gas precipitation may damage the battery plates and activate material shedding on them. Too high of an equalizing charge or too long of one may cause damage. Carefully review the requirements of the specific battery in use.

■ CAUTION

- Install the inverter in a well-ventilated, cool, and dry environment. Make sure the fans of the inverter and the ventilation holes are not blocked.
- Do not expose the unit to rain, moisture, snow, or liquids of any type.

Renogy Support

To discuss inaccuracies or omissions in this quick guide or user manual, visit or contact us at:

[G | renogy.com/support/downloads](https://renogy.com/support/downloads)

 contentservice@renogy.com

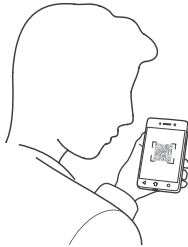

Questionnaire Investigation



To explore more possibilities of solar systems, visit Renogy Learning Center at:

[G | renogy.com/learning-center](https://renogy.com/learning-center)

For technical questions about your product in the U.S., contact the Renogy technical support team through:

[G | renogy.com/contact-us](https://renogy.com/contact-us)

 1(909)2877111

For technical support outside the U.S., visit the local website below:

Canada |  | ca.renogy.com

China |  | www.renogy.cn

Australia |  | au.renogy.com

Japan |  | renogy.jp

South Korea |  | kr.renogy.com

Germany |  | de.renogy.com

United Kingdom |  | uk.renogy.com

Other Europe |  | eu.renogy.com

FCC Statement

This device complies with Part 15 of the FCC Rules. Operation is subject to the following two conditions:

- (1) This device may not cause harmful interference.
- (2) This device must accept any interference received, including interference that may cause undesired operation.

Any Changes or modifications not expressly approved by the party responsible for compliance could void the user's authority to operate the equipment.

This equipment has been tested and found to comply with the limits for a Class B digital device, pursuant to Part 15 of the FCC Rules. These limits are designed to provide reasonable protection against harmful interference in a residential installation. This equipment generates, uses and can radiate radio frequency energy and, if not installed and used in accordance with the instructions, may cause harmful interference to radio communications. However, there is no guarantee that interference will not occur in a particular installation. If this equipment does cause harmful interference to radio or television reception, which can be determined by turning the equipment off and on, the user is encouraged to try to correct the interference by one or more of the following measures:

- (1) Reorient or relocate the receiving antenna.
- (2) Increase the separation between the equipment and receiver.
- (3) Connect the equipment into an outlet on a circuit different from that to which the receiver is connected.
- (4) Consult the dealer or an experienced radio / TV technician for help.

FCC Radiation Exposure Statement

This equipment complies with FCC radiation exposure limits set forth for an uncontrolled environment. This equipment should be installed and operated with minimum distance 20 cm between the radiator & your body.



Renogy Empowered

Renogy aims to empower people around the world through education and distribution of DIY-friendly renewable energy solutions.

We intend to be a driving force for sustainable living and energy independence.

In support of this effort, our range of solar products makes it possible for you to minimize your carbon footprint by reducing the need for grid power.



Live Sustainably with Renogy

Did you know? In a given month, a 1 kW solar energy system will...



Save 170 pounds of coal from being burned



Save 300 pounds of CO₂ from being released into the atmosphere



Save 105 gallons of water from being consumed



Renogy Power PLUS

Renogy Power Plus allows you to stay in the loop with upcoming solar energy innovations, share your experiences with your solar energy journey, and connect with like-minded people who are changing the world in the Renogy Power Plus community.



@Renogy Solar



@renogyofficial



@Renogy

Renogy reserves the right to change the contents of this manual without notice.



FCC ID : 3ANPB-RV1250PU