



DW60H6050FW
DW60H6050FS

Dishwasher user manual

imagine the possibilities

Thank you for purchasing this Samsung product.

SAMSUNG

Safety information

Please read this User Information carefully and keep it to refer to at a later date. Pass it on to any subsequent owner of the appliance.

This manual contains sections of Safety Instructions, Part and Features, Installation your dishwasher and Troubleshooting etc.

Carefully reading it before using the dishwasher will help you to use and maintain the dishwasher properly.



The manufacturer, following a policy of constant development and up-dating of the product, may make modifications without giving prior notice.



WARNING: When using your dishwasher, follow the below basic precautions including the following:

PROPER USE

- Do not abuse, sit on, or stand on the door or dish rack of the dishwasher.
- Do not operate your dishwasher unless all enclosure panels are properly in place. Open the door very carefully if the dishwasher is operating. There is a risk of water squirting out.
- Do not place any heavy objects of stand on the door when it is open. The appliance could tip forward.
- When loading items to be washed:
 - Locate sharp items so that they are not likely to damage the door seal;
 - Load sharp knives with the handles up to reduce the risk of cut-type injuries;
- Warning : knives and other utensils with sharp points must be loaded in the basket with their points down or placed in a horizontal position.
- Check that the detergent receptacle is empty after completion of the wash cycle.
- Do not wash plastic items unless they are marked dishwasher safe or the equivalent. For plastic items not so marked, check the manufacturer's recommendations.
- Use only detergent and rinse additives designed for an automatic dishwasher. Never use soap, laundry detergent, or hand washing detergent in your dishwasher.
- Other means for disconnection from the supply must be incorporated in the fixed wiring with at least 3 mm contact separation in all poles.
- Keep children away from detergent and rinse aid, keep children away from the open door of the dishwasher, there could still be some detergent left inside.
- Young children should be supervised to ensure that they do not play with the appliance.
- The appliance is not intended for use by young children or infirm persons without supervision.
- Dishwasher detergents are strongly alkaline. They can be extremely dangerous if swallowed. Avoid contact with skin and eyes and keep children away from the dishwasher when the door is open.
- The door should not be left in the open position since this could present a tripping hazard.
- If the supply cord is damaged, it must be replaced by the manufacturer or its service agent or a similarly qualified person in order to avoid a hazard.
- Please dispose of packing materials properly.
- Use the dishwasher only for its intended function.
- During installation, the power supply must not be excessively or dangerously bent or flattened.
- Do not tamper with controls.
- The appliance is to be connected to the water mains using new hose sets and the old hose-sets should not be reused.

**READ AND FOLLOW THIS SAFETY INFORMATION
CAREFULLY SAVE THESE INSTRUCTIONS**

DISPOSAL

Dispose of the dishwasher packaging material correctly.

All packaging materials can be recycled.

Plastic parts are marked with the standard international abbreviations:

PE for polyethylene, e.g. sheet wrapping material

PS for polystyrene, e.g. padding material

POM polyoxymethylene, e.g. plastic clips

ABS Acrylonitrile Butadiene Styrene, e.g. Control Panel.



WARNING: Packaging material could be dangerous for children!

For disposing of package and the appliance please go to a recycling centre. Therefore cut off the power supply cable and make the door closing device unusable.

Cardboard packaging is manufactured from recycled paper and should be disposed in the waste paper collection for recycling.

By ensuring this product is disposed of correctly, you will help prevent potential negative consequences for the environment and human health, which could otherwise be caused by inappropriate waste handling of this product.

For more detailed information about recycling of this product, please contact your local city office and your household waste disposal service.

**READ AND FOLLOW THIS SAFETY INFORMATION
CAREFULLY SAVE THESE INSTRUCTIONS**

Contents

PART AND FEATURES	5	Dishwasher features
	5	Control panel
	7	Displays
INSTALLING YOUR DISHWASHER	8	Water supply and drain
	10	Connection of drain hoses
	10	Position the appliance
	10	Start of dishwasher
USING THE DETERGENT	11	Fill the rinse aid dispenser
	13	Function of detergent
	15	How to use the Multi in 1 option
LOADING THE DISHWASHER RACKS	16	Loading the upper basket
	17	Loading the lower basket
	18	Folding back the cup shelves
	18	Folding spikes of lower basket
	19	Cutlery(silverware) basket
	20	For washing in the dishwasher the following cutlery/dishes
WASHING PROGRAMMES	21	Turning on the appliance
	21	Change the program...
	22	At the end of the wash cycle
	22	Wash cycle table
CLEANING AND CARE	24	Cleaning the filters
	25	Cleaning the spray arms
	25	Cleaning the door
	25	Caring for the dishwasher
	25	Protect against freezing
	26	How to keep your dishwasher in shape
TROUBLESHOOTING	27	Before calling for service
	30	Error codes
APPENDIX	31	Specifications
	31	Product dimension

Part and features

DISHWASHER FEATURES

Front & Rear view

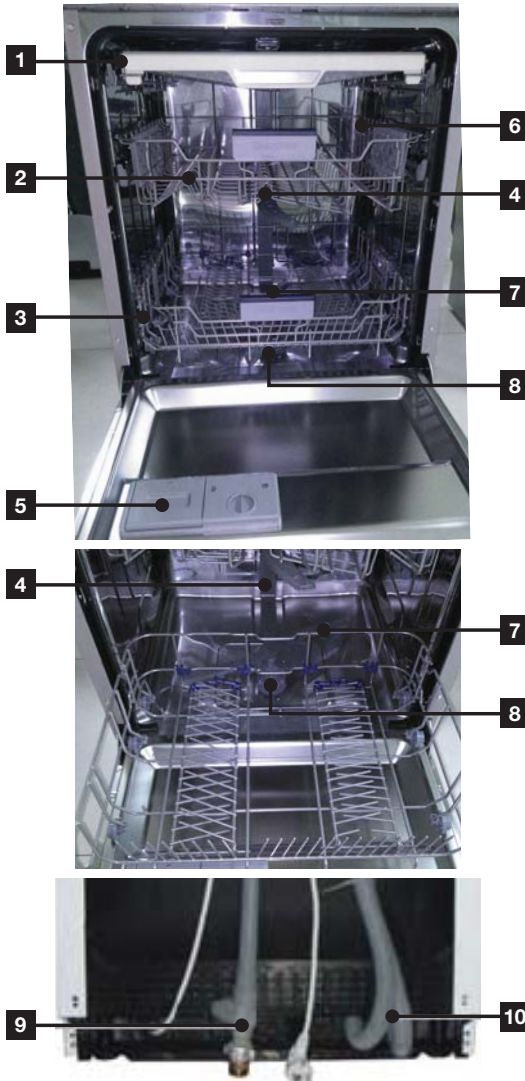

1	3rd Rack
2	Upper Basket
3	Lower Basket
4	Duct Nozzle
5	Dispenser
6	Cup Shelf
7	Spray arms
8	Filter assembly
9	Inlet hose
10	Drain hose

 Accessory parts - User manual, cutlery basket.

Part and features

CONTROL PANEL









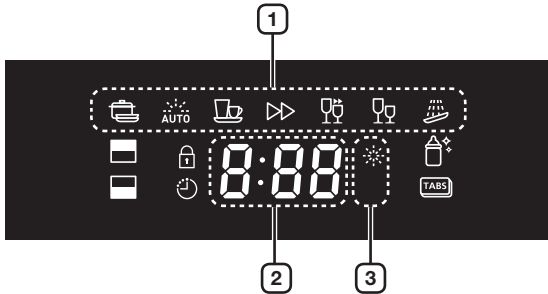

1 POWER BUTTON	Press this button to turn on your dishwasher: the screen lights up.
2 PROGRAM BUTTON	To select washing program press this button.
3 HALF LOAD BUTTON	For small amount of loading items, use either the upper or lower basket only to save energy. Press the Half load button to select the upper or lower basket.
4 CHILD LOCK BUTTON	This option allows you to lock the buttons on the control panel so children cannot accidentally start the dishwasher by pressing the buttons on the panel. To lock and unlock the buttons on the control panel, hold down both the Child lock buttons for three (3) seconds.
5 DISPLAY WINDOW	Running indicator, delay time, error codes and etc.
6 START BUTTON	In Power on condition, close the dishwasher door and select the cycle and desired options. Press the START button to begin the cycle. When you want to pause the dishwasher while running, press the START button and make sure to open the door slowly and carefully. You can reset the machine by pressing the START button for 3 seconds during washing. After reset, the dishwasher goes to the initial state.
7 DELAY START BUTTON	Press this button to set the delayed hours for washing. You can delay the start of washing up to 24 hours. One press on this button delays the start of washing by one hour.
8 HYGIENE BUTTON	Push the Hygiene button for the best possible hygiene in your dishwasher. At the final rinse it heat up to 67 °C and hold this temperature for a several minutes. This function is available with all program except Pre Wash, Delicate and Quick Wash.
9 MULTI IN 1 BUTTON	To select Multi in 1 option which needs rinse aid but a Multi in 1 tablet. This option can be selected on Intensive, Auto or Normal program only.

- When the door is open only the **POWER** button will operate.
- You can select options (**Multi in 1**, **Delay start** and/or **Half load**) before starting a cycle.

IMPORTANT: To get the best performance from your dishwasher, read all the operating instructions before using it for the first time.

DISPLAYS



1	PROGRAM ICONS	When press the Program button, each program is selected.
	INTENSIVE	Heavily soiled items include pots and pans
	AUTO WASH	Lightly to heavily soiled daily using items, automatic detection of the amount of soils.
	NORMAL	Normally soiled daily using items, with reduced energy and water consumptions.
	EXPRESS	Common soiled daily using items, with short cycle time.
	DELICATE	Lightly soiled delicate items.
	QUICK WASH	Lightly soiled with very short cycle time.
	PRE WASH	Cold rinse for remove only dirt on dishes stored for a long time or soaking dishes which are dried up before other programme running.
2	3*8 SEGMENT	Display the remaining time, error code, or delay time.
3	REFILL INDICATORS	If Rinse indicator is lit, it means rinse is needed to refill.
	RINSE REFILL INDICATOR	If the “Rinse Refill” indicator is lit, it means the dishwasher is low on dishwasher rinse aid and requires a refill. To refill the rinse reservoir, refer to the “When to refill the rinse aid dispenser” section on page 11.

Installing your dishwasher



WARNING : Electrical shock hazard

Disconnect electrical power before installing dishwasher.
Failure to do so could result in death or electrical shock.



ATTENTION: The installation of the pipes and electrical equipments should be done by professionals.

About electricity connecting



CAUTION, for personal safety:

DO NOT USE AN EXTENSION CORD OR AN ADAPTER PLUG WITH THIS APPLIANCE.
DO NOT, UNDER ANY CIRCUMSTANCES, CUT OR REMOVE THE THIRD GROUNDING PRONG FROM THE POWER CORD.

Electrical requirements

- An AC 220-240 V / 50 Hz fuse or a circuit breaker.
- An individual branch circuit serving your dishwasher.

Grounding instructions



Insure proper ground exists before use



This appliance must be grounded. In the event of a malfunction or breakdown, grounding will reduce the risk of electric shock by providing a path of least resistance of electric current. This appliance is equipped with a cord having an equipment-grounding conductor and a grounding plug. The plug must be plugged into an appropriate outlet that is installed and grounded in accordance with all local codes and ordinances.



WARNING: Improper connection of the equipment grounding conductor can result in the risk of an electric shock. Check with a qualified electrician or service representative if you are in doubt whether the appliance is properly grounded. Do not modify the plug provided with the appliance.

WATER SUPPLY AND DRAIN

Cold water connection

Connect the cold water supply hose to a threaded 3/4 (inch) connector and make sure that it is fastened tightly in place.

If the water pipes are new or have not been used for an extended period of time, let the water run to make sure that the water is clear. This precaution is needed to avoid the risk of the water inlet to be blocked and damage the appliance.



Provided water supply hose has the aqua-safe system. Ensure that water supply hose's aqua-safe pipe is connected to the faucet.



Hot water connection

The water supply to the appliance can also be connected to the house hot water line (centralized system, heating system), as long as it does not exceed a temperature of 60 °C. In this case, the wash cycle time will be shortened by about 15 minutes and the wash efficiency slightly reduced. The connection must be made to the hot water line following the same procedures as those for the connection to the cold water line.



Positioning the appliance

Position the appliance in the desired location. The back should rest against the wall behind it, and the sides, along the adjacent cabinets or wall. The dishwasher is equipped with water supply and drain hoses that can be positioned to the right or the left to facilitate proper installation.

How to drain excess water from hoses

If the sink is 1000 mm higher from the floor, the excess water in hoses cannot be drained directly into the sink. It will be necessary to drain excess water from hoses into a bowl or suitable container that is held outside and lower than the sink.

Water outlet

Connect the water drain hose. The drain hose must be correctly fitted to avoid water leaks. Ensure that the water inlet hose is not kinked or squashed.

Extension hose

If you need a drain hose extension, Use a similar size and quality drain hose.

It must be no longer than 4 metres; otherwise the cleaning effect of the dishwasher could be reduced.

Syphon connection

The waste connection must be at a height of between 40 cm (minimum) and 100 cm (maximum) from the bottom of the dishwasher. The water drain hose should be fixed by a hose clip.

Aqua-safe

The Aqua-safe System is a safety valve system, preventing water leaks. If the water inlet hose starts to leak anytime, the safety valve cuts off the running water. If the water inlet hose or the safety valve is damaged, remove and replace it.

Do not enlarge or shorten the inlet hose.

Installing your dishwasher

CONNECTION OF DRAIN HOSES

Insert the drain hose into a drain pipe with a minimum diameter of 4 cm, or let it run into the sink, making sure to avoid bending or crimping it. The top of the hose must be at a height between 40 and 100 cm. The free end of the hose must not be immersed in water to avoid the back flow of it.

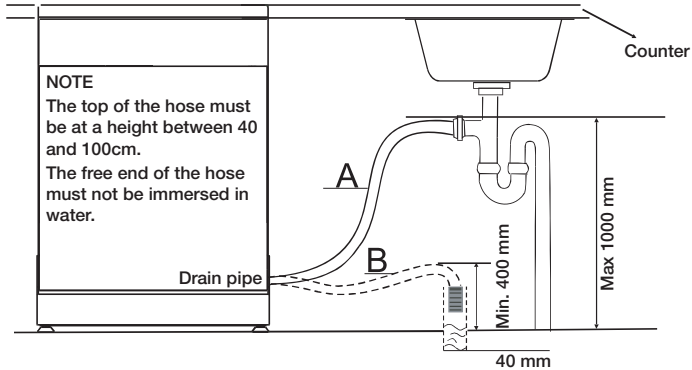

POSITION THE APPLIANCE

Position the appliance in the desired location. The back should rest against the wall behind it, and the sides, along the adjacent cabinets or walls. The dishwasher is equipped with water supply and drain hoses that can be positioned either to the right or the left sides to facilitate proper installation.

Levelling the Appliance

Once the appliance is positioned for levelling, the height of the dishwasher may be altered via adjustment of the screwing level of the feet. In any case, the appliance should not be inclined more than 2°.

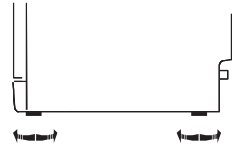

START OF DISHWASHER

The followings should be checked before starting the dishwasher.

1. the dishwasher is level and fixed.
2. the inlet valve is opened.
3. there leakage at the connections of the conducts.
4. the wires are tightly connected.
5. the power is switched on.
6. the inlet and drain hoses are not knotted.
7. All packing materials and printings should be taken out from the dishwasher.

⚠ ATTENTION: After installation please put this manual in a safe place. The contents of this manual can be useful to users.

Using the detergent

FILL THE RINSE AID DISPENSER

Function of rinse aid

Rinse aid is automatically added during the last rinse, ensuring thorough rinsing, and spot and streak free drying.

⚠ ATTENTION: Only use branded rinse aid for dishwasher. Never fill the rinse aid dispenser with any other substances (e.g. dishwasher cleaning agent, liquid detergent). This would damage the appliance.

When to refill the rinse aid dispenser

If there is no rinse-aid warning light in the control panel, you can judge the amount of rinse-aid by the Colour of the optical level indicator "D" located next to the cap. When the rinse-aid container is full, the whole indicator will be dark. As the rinse-aid diminishes, the size of the dark dot decreases. You should never let the rinse aid get below 1/4 full.

As the rinse aid diminishes, the size of the black dot on the rinse aid level indicator changes, as illustrated below.

- Full
- ◐ 3/4 full
- ◑ 1/2 full
- ◒ 1/4 full : Should refill to eliminate spotting
- Empty

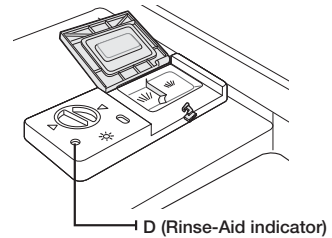

Using the detergent

Rinse Aid dispenser

1. To open the dispenser, turn the cap to the "open" (left) arrow and lift it out.



2. Pour the rinse aid into the dispenser, being careful not to overfill.



3. Replace the cap by inserting it aligned with "open" arrow and turning it to the closed (right) arrow.



The rinse aid is released during the final rinse to prevent water from forming droplets on your dishes that can leave spots and streaks. It also improves drying by allowing water to run off the dishes.

Your dishwasher is designed to use liquid rinse aids. The rinse aid dispenser is located inside the door next to the detergent dispenser. To fill the dispenser, open the cap and pour the rinse aid into the dispenser until the level indicator turns completely black. The volume of the rinse aid container is about 130 ml.

Be careful not to overfill the dispenser, because this could cause over sudsing. Wipe away any spills with a damp cloth. Don't forget to replace the cap before you close dishwasher door.

 **ATTENTION:** Clean up any rinse aid spilt during filling with an absorbent cloth to avoid excess foaming during the next wash.

Adjusting rinse aid dispenser

The rinse aid dispenser has four settings. Always start with the dispenser set on "3". If spots and poor drying are problems, increase the amount of rinse aid dispensed by removing the dispenser lid and rotating the dial to "4". We suggest you to set on "3" (Factory value is "3").



 Increase the dose if there are drops of water or lime spots on the dishes after washing. Reduce it if there are sticky whitish streaks on the dishes or a bluish film on glassware or knife blades.

FUNCTION OF DETERGENT

Detergents with its chemical ingredients are necessary to remove dirt, crush dirt and transport it out of the dishwasher. Most of commercial quality detergents are suitable for this purpose.

⚠ WARNING: Dishwasher detergent is corrosive! Take care to keep it out of reach of children.



Proper Use of Detergent

Use only detergent specifically made for use in dishwashers. Keep your detergent fresh and dry. Don't put powder detergent into the dispenser until you're ready to wash dishes.

Concentrated detergent

Based on their chemical composition, dishwasher detergent can be split in two basic types:

- conventional, alkaline detergents with caustic components
- low alkaline concentrated detergents with natural enzymes

The use of "normal" washing programmes in conjunction with concentrated detergents reduces pollution and is good for your dishes; these wash programmes are specially matched to the dirt-dissolving properties of the enzymes of the concentrated detergent. For this reason "normal" wash programmes in which concentrated detergents are used can achieve the same results that can otherwise only be achieved using "intensive" programmes.

Detergent tablets

Detergent tablets of different brands dissolve at different speeds. For this reason some detergent tablets cannot dissolve and develop their full cleaning power during short programmes. Therefore please use long programmes when using detergent tablets, to ensure the complete removal of detergent residuals.

Detergent dispenser

The dispenser must be refilled before the start of each wash cycle following the instructions provided in the Wash Cycle Table. Your dishwasher uses less detergent and rinse aid than conventional dishwashers. Generally, only one tablespoon of detergent is needed for a normal wash load. Also, more heavily soiled items need more detergent. Always add the detergent just before starting the dishwasher, otherwise it could get damp and will not dissolve properly.

Fill the detergent in dispenser

1. If the lid is closed: press release button. The lid springs open.

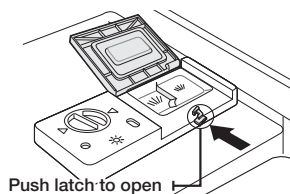

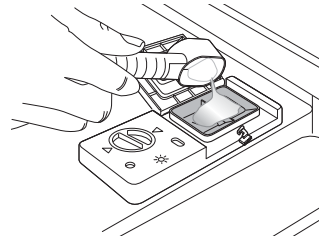

2. Always add the detergent just before starting each wash cycle. Only use branded detergent aid for dishwasher.



Using the detergent

Amount of detergent to use

1. Fill the detergent dispenser with detergent.
The marking indicates the dosing levels, as illustrated on right:
 - A. This section is for main wash detergent, approximately 27.5 g
 - B. This section is for the pre wash detergent, approximately 5 g

-  If the dishes are heavily soiled, place an additional detergent dose in the pre-wash detergent chamber. This detergent will take effect during the pre-wash phase.
-  You can find information about the amount of detergent for the single programmes on the "Wash cycle table". (See page 22)
Please be aware, that according to the soiling level and the specific hardness of water differences are possible.

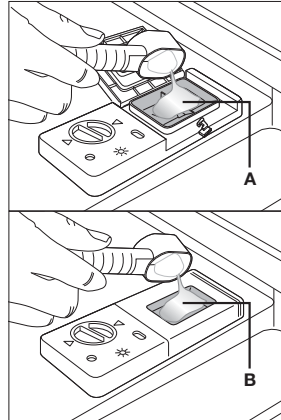

2. Close the lid and press until it locks in place.

-  Please observe the manufacturers dosing and storage recommendations as stated on the detergent packaging.

Detergents

There are 3 sorts of detergents.

1. With phosphate and with chlorine.
2. With phosphate and without chlorine.
3. Without phosphate and without chloride.

Normally new pulverised detergent is without phosphate. If detergents without phosphate were used in case of hard water often white spots appear at dishes and glasses. In this case please add more detergent to reach better results. Detergents without chlorine do only bleach a little. Strong and coloured spots will not removed completely. In this case please choose a programme with higher temperature.

HOW TO USE THE MULTI IN 1 OPTION

Your dishwasher has a Multi in 1 option which does not need rinse aid but a 3 In1 tablet. This option can select on Intensive, Normal program only.

 The Multi in 1 setting is only for use with Multi in 1 tablets. If using Multi in 1 tablet without this option, the appliance will not get it's best performance.

1. Put the Multi in 1 tablet into the container then start the Multi in 1 option.
2. Close the lid and press until it locks in place.

 When using Multi in 1 compact combination detergents ensure that the lid can be closed correctly.

 **ATTENTION:** Keep all detergents in a safe place out of children's reach. Always add the detergent in the dispenser just before starting the dishwasher.



Loading the dishwasher racks

For best performance of the dishwasher, follow these loading guidelines. Features and appearance of racks and silverware baskets may vary from your model.

⚠ Attention before or after loading the dishwasher racks

Scrape off any large amounts of leftover food. It is not necessary to rinse the dishes under running water. Place objects in the dishwasher in the following order:

1. Items such as cups, glasses, pots/pans, etc. are stood upside down.
2. Curved items, or those with recesses, should be at a slant so that water can run off.
3. They are stacked securely and can not tip over.
4. They do not prevent the spray arms from rotating while washing takes place.

Very small items should not be washed in the dishwasher as they could easily fall out of the racks.

🗑 Removing the dishes

To prevent water dripping from the upper basket into the lower basket, we recommend that you empty the lower basket first and then the upper basket.

LOADING THE UPPER BASKET

The upper basket is designed to hold more delicate and lighter dishware such as glasses, coffee and tea cups and saucers, as well as plates, small bowls and shallow pans (as long as they are not too dirty).

Position the dishes and cookware so that they will not get moved by the spray of water. Always place glasses, cups & bowls upside down.

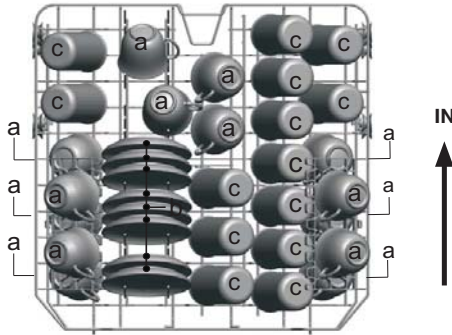

14 place setting

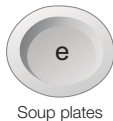
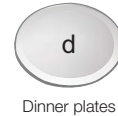

Adjusting the Upper Basket

The height of the upper basket can be adjusted in order to create more space for large utensils both for the upper/lower basket.

1. To lower the upper rack, press the "A" levers located at the left and right sides of the upper basket and push the upper basket downwards slightly at the same time.
2. To raise the upper rack, just pull the upper basket upwards without operating any levers.

⚠ Caution: We recommend adjusting the height of the upper basket before loading dishes into the basket. If you adjust the the basket after loading the dishes, you may damage the dishes.

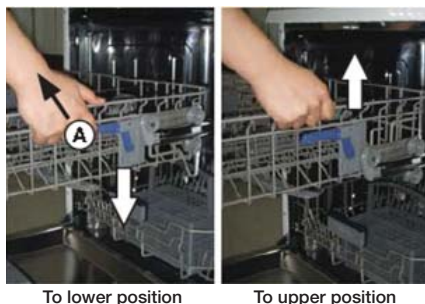

LOADING THE LOWER BASKET

We recommend that you place large items which are most difficult to clean in to the lower rack: pots, pans, lids, serving dishes and bowls, as shown in the figure to the right. It is preferable to place serving dishes and lids on the side of the racks in order to avoid blocking the rotation of the top spray arm. Pots, serving bowls, etc. must always be placed top down. Deep pots should be slanted to allow water to flow out.

The bottom rack feature fold down tine rows so that larger or more pots and pans can be loaded.

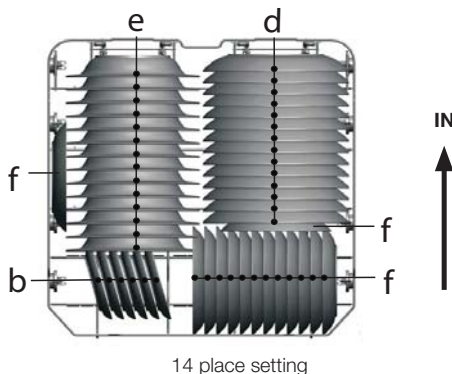

Saucers



Dinner plates



Soup plates



Dessert dishes

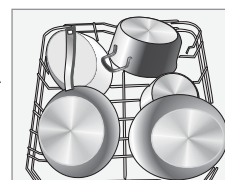

⚠ Long items, serving cutlery, salad servers and big knives should be placed on the shelf so that they do not obstruct the rotation of the spray arms.

Loading the dishwasher racks

FOLDING BACK THE CUP SHELVES

For better stacking of pots and pans, the shelves can be folded down as shown in the picture below.



FOLDING SPIKES OF LOWER BASKET





For better stacking of pots and pans, the spikes can be folded down as shown in the picture right.

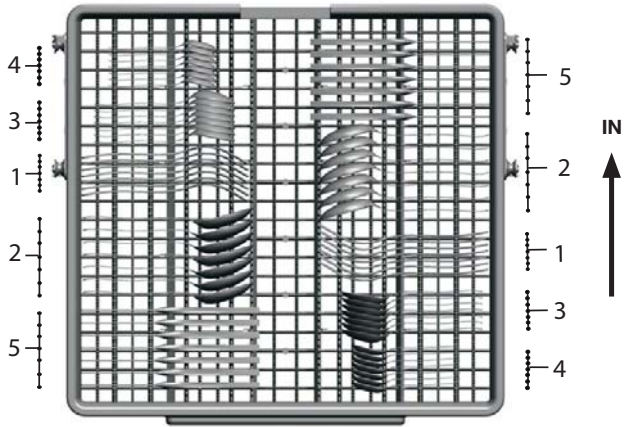

CUTLERY(SILVERWARE) BASKET

Silverware should be placed in the cutlery basket with handles at the bottom: The spoon should be loaded individually into the appropriate slots, especially long utensils should be placed in the horizontal position at the front of the upper basket.



1	Forks		4	Teaspoons	
2	Soup spoons		5	Knives	
3	Dessert spoons				





WARNING

- Do not let any item extend through the bottom.
- Always load sharp utensils with the sharp point down!

Loading the dishwasher racks

FOR WASHING IN THE DISHWASHER THE FOLLOWING CUTLERY/ DISHES

Are not suitable	Are of limited suitability
<p>Cutlery with wooden, horn china or mother-of-pearl handles.</p> <p>Plastic items that are not heat resistant Older cutlery with glued parts that is not temperature resistant Bonded cutlery items or dishes Pewter or cooper items Lead crystal glass Steel items subject to rusting Wooden platters Items made from synthetic fibres.</p>	<p>Some types of glasses can become dull after a large number of washes.</p> <p>Silver and aluminium parts have a tendency to discolour during washing.</p> <p>Glazed patterns may fade if machine washed frequently.</p>

-  Do not try and wash items soiled with cigarette ash, candle wax, lacquer or paint. If you buy new dishes please make sure that they are suitable for dishwashers.
-  Please do not overload your dishwasher. There is only space for 12 standard dishes. Do not use dish that are not suitable for dishwashers. This is important for good results and for reasonable energy consumption.

When loading the dishes and cutlery

Dishes and cutlery must not impede the rotation of the spray arms.
 Load hollow items such as cups, glasses, pans etc. with the opening downwards so that water cannot collect in the container or a deep base.

-  Dishes and items of cutlery must not lie inside one another, or cover each other
 - To avoid damage to glasses, they must not touch.
 - Load large items which are most difficult to clean into the lower rack.
 - The upper rack is designed to hold more delicate and lighter dishware such as glasses, coffee and tea cups.

 **ATTENTION**
 Long bladed knives stored in an upright position are a potential hazard!
 Long and/or sharp items of cutlery such as carving knives must be positioned horizontally in the upper basket.

Damage to glassware and other dishes.

Possible causes	Suggested remedy
<ul style="list-style-type: none"> • Type of glass or manufacturing process. • Chemical composition of detergent. • Water temperature and duration of dishwasher programme. 	<ul style="list-style-type: none"> • Use glassware or porcelain dishes that have been marked dishwasher-proof by the manufacturer • Use a mild detergent that is described as kind of dishes If necessary, seek further information from detergent manufacturers. • Select a programme with as low a temperature. • To prevent damage, take glass and cutlery out of the dishwasher as soon as possible after the programme has ended.

Washing programmes

TURNING ON THE APPLIANCE

Starting a cycle wash

1. Draw out the lower and upper basket, load the dishes and push them back..
It is recommended to load the lower basket first, then the upper one (see the section entitled "Loading the dishwasher racks").
2. Pour in the detergent (see the section entitled "Using the detergent").
3. Insert the plug into the socket. The power supply is 220-240 VAC / 50 HZ, the specification of the socket is 15A 250 VAC. Make sure that the water supply is turned on to proper pressure.
4. Close the door, press the **POWER** button, to switch on the machine.
5. Press the **Program** button, the wash program will be changed as follows direction:

Program **Normal** → **Express** → **Quick Wash** → **Delicate** → **Pre Wash** → **Intensive** → **Auto**

If a wash program is selected, the response light will light. Then press the **START** button, the dishwasher begins to start.

-  When you press the **START** button to pause during washing, the running indicator will stop blinking and the dishwasher will beep every minute unless you press the **START** button to start.

CHANGE THE PROGRAM...

Premise:

1. A cycle that is underway can only be modified if it has only been running for a short time. Otherwise, the detergent may have already been released, and the appliance may have already drained the wash water. If this is the case, the detergent dispenser must be refilled (see the section entitled "Fill the detergent in dispenser").
2. Press the **START** button, the machine will be in standby state, press the **Program** button more than 3 seconds then you can change the program to the desired cycle setting.

-  If you open the door during a wash cycle, the machine will pause. The program light will stop blinking and the buzzer will beep every minute unless you close the door. After you close the door, the machine will keep on working after 3 seconds automatically.
If your model has broken memory function, the machine will go on to finish the selected program after the power cut.

Add a dish

A forgotten dish can be added at any time before the detergent dispenser opens.

1. Press the **START** button and make sure to open the door slowly and carefully as there is a possibility of injury from the hot steam inside the dishwasher.
2. After the spray arms stop working, you can open the door completely.
3. Add forgotten dishes.
4. Close the door. The dishwasher will work after 3 seconds.

-  **WARNING:** It is dangerous to open the door when washing, because the hot water may scald you. If the door is opened while the dishwasher is running, a safety mechanism is activated and stops the cycle.

Washing programmes

AT THE END OF THE WASH CYCLE

When the working cycle has finished, the buzzer of dishwasher will beep shortly, then stop. In the digital display appears "End", only in this case the programme has ended.

1. Switch off the dishwasher by pressing the **POWER** button.
2. Turn off the water tap!

 **Open the door carefully. Hot steam may escape when the door is opened!**

- Hot dishes are sensitive to knocks. The dishes should be allowed to cool down around 15 minutes before removing from the appliance.
- Open the dishwasher's door, leave it and wait a few minutes before removing the dishes. In this way they will be cooler and the drying will be improved.
- Unloading the dishwasher.

 It is normal that the dishwasher is wet inside.
Empty the lower basket first and then the upper one. This will avoid water dripping from the upper basket onto the dishes in the lower one.

WASH CYCLE TABLE

DW60H6050

Program	Description of cycle	Detergent (Prewash/Main wash) (g)	Running time (min)	Energy (kWh)	Water (ℓ)
Intensive	Pre Wash (50 °C)	5/27.5	175	1.65	18
	Wash (60 °C)				
	Rinse				
	Rinse				
	Rinse (65°C)				
	Drying				
Intensive + Hygiene	Pre Wash (50 °C)	5/27.5	195	1.75	18
	Wash (60 °C)				
	Rinse				
	Rinse				
	Rinse (70 °C)				
	Drying				
Normal	Pre Wash	5/27.5	165	0.74	12.5
	Wash (45°C)				
	Rinse				
	Rinse (50 °C)				
	Drying				
Normal + Hygiene	Pre Wash	5/27.5	180	1.05	12.5
	Wash (45°C)				
	Rinse				
	Rinse (70 °C)				
	Drying				

Program	Description of cycle	Detergent (Prewash/Main wash) (g)	Running time (min)	Energy (kWh)	Water (ℓ)
Delicate	Pre Wash	5/27.5	115	0.9	14
	Wash (40 °C)				
	Rinse				
	Rinse (60 °C)				
	Drying				
Express	Pre Wash	5/27.5	60	1	10.5
	Wash (60 °C)				
	Rinse (60 °C)				
	Drying				
Express + Hygiene	Pre Wash	5/27.5	80	1.25	10.5
	Wash (60 °C)				
	Rinse (70 °C)				
	Drying				
Quick Wash	Wash (40 °C)	20	35	0.6	11.5
	Rinse				
	Rinse (45°C)				
Quick Wash + Hygiene	Wash (40 °C)	20	50	1.15	11.5
	Rinse				
	Rinse (70 °C)				
Auto	Pre Wash (45 °C)	5/27.5	120 ~ 180	0.9 ~ 1.3	8.5 ~ 12.5
	Auto (45 ~ 55 °C)				
	Rinse				
	Rinse (60 °C)				
	Drying				
Auto + Hygiene	Pre Wash (45 °C)	5/27.5	120 ~ 180	0.9 ~ 1.3	8.5 ~ 12.5
	Wash (45 ~ 55 °C)				
	Rinse				
	Rinse (70 °C)				
	Drying				

 * AS/NZS 2007.1: This program is the test cycle. The information for comparability test in accordance with AS/NZS 2007.1, as follows.;

- Capacity: 14 place setting
- Position of Upper Basket: to lower position
- Rinse aid setting: 4

 The wash time varies depending on the pressure and temperature of the supplied water.

 Open the door slightly 50mm to assist in drying of the dishes after every wash.

Cleaning and care

CLEANING THE FILTERS

Filtering system

For your convenience, we have placed the drain pump and filtering system within easy reach inside the tub. There are three components of the filtering system: the main filter, the coarse filter, and the fine filter.

1. **Main filter:** Food and soil particles trapped by this filter are pulverized by a special jet on the lower spray arm and washed down the drain.
2. **Coarse filter:** Larger items, such as pieces of bone or glass, that could clog the drain are trapped in the coarse filter. To remove an item caught in this filter, gently squeeze the tabs on top of this filter and lift it out.
3. **Fine filter:** This filter holds soil and food residue in the sump area and prevents it from being redeposited on the dishes during a cycle.

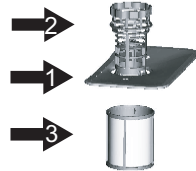

⚠ ATTENTION: Do not put the fine filter upside down.

Filter assembly

For best performance and results, the filter assembly must be cleaned. The filter efficiently removes food particles from the wash water, allowing it to be recirculated during the cycle. For this reason, it is a good idea to remove the larger food particles trapped in the filter after each wash cycle by rinsing the semicircular filter and cup under running water. To remove the filter assembly, turn it in anti-clockwise direction and lift the filter assembly up. The entire filter assembly should be cleaned regularly.

To clean the coarse filter and the fine filter, use a cleaning brush. Then, reinsert the entire assembly in the dishwasher, positioning in its seat, pressing downward, turning it clockwise direction.



The dishwasher must never be used without the filters. Improper replacement of the filter may reduce the performance level of the appliance and damage dishes and utensils.

⚠ WARNING: Never run the dishwasher without the filters in place. When cleaning the filters, do not damage them. Otherwise the filters may not perform as intended and poor wash results or damage to the internal parts may be encountered.

CLEANING THE SPRAY ARMS

It is necessary to clean the spray arms regularly as hard water chemicals may clog the spray arm jets and bearings. To remove the middle spray arm, hold the nut, rotate the arm clockwise to remove it. To remove the lower spray arm, pull out the spray arm upward. Wash the arms in soapy and warm water and use a soft brush to clean the jets. Replace them after rinsing them thoroughly.

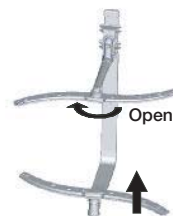

CLEANING THE DOOR

To clean the edge around the door, you should use only a soft warm, damp rag. To prevent penetration of water into the door lock and electrical components, do not use a spray cleaner of any kind.

Also, never use abrasive cleaners or scouring pads on the outer surfaces because they will scratch the finish. Some papers towels can also scratch or leave marks on the surface.

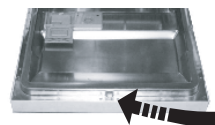

⚠ WARNING: Never use a spray cleaner to clean the door panel for it could damage the door lock and electrical components. It is not advised to use the abrasive agent or some paper towel because of the risk of scratching or leaving spots on the stainless steel surface.

CARING FOR THE DISHWASHER

To clean the control panel use a lightly damp cloth then dry thoroughly. To clean the exterior use a good appliance polish wax.

Never use sharp objects, scouring pads or harsh cleaners on any part of the dishwasher.

PROTECT AGAINST FREEZING

If your dishwasher is left in an unheated place during the winter:

1. Cut off electrical power to the dishwasher.
2. Turn off the water supply and disconnect the water inlet pipe from the water valve.
3. Drain water from the inlet pipe and water valve. (Use a pan to catch the water)
4. Reconnect the water inlet pipe to the water valve.
5. Remove the filter in the tub the bottom and use a sponge to use up water in sump.

Cleaning and care

HOW TO KEEP YOUR DISHWASHER IN SHAPE

- **After Every Wash**

After every wash, turn off the water supply to the appliance and leave the door slightly ajar so that moisture and odours not trapped inside.

- **Remove the Plug**

Before cleaning or performing maintenance, always remove the plug from the socket.

- **No Solvents or Abrasive cleaning**

To clean the exterior and rubber parts of the dishwasher, do not use solvents or abrasive cleaning products. Use only a cloth and warm soapy water. To remove spots or stains from the surface of the interior, use a cloth dampened with water and a little white vinegar, or a cleaning product made specifically for dishwashers.

- **When You Go on Holiday**

When you go on holiday, it is recommended that you run a wash cycle with the dishwasher empty and then remove the plug from the socket, turn off the water supply and leave the door of the appliance slightly ajar. This will help the seals last longer and prevent odours from forming within the appliance.

- **Moving the Appliance**

If the appliance must be moved, try to keep it in the vertical position. If absolutely necessary, it can be positioned on its back.

- **Seals**

One of the factors that cause odours to form in the dishwasher is food that remains trapped in the seals. Periodic cleaning with a damp sponge will prevent this from occurring.

Troubleshooting

The manufacturer, following a policy of constant development and up-dating of the product, may make modifications without giving prior notice.

BEFORE CALLING FOR SERVICE

PROBLEM	POSSIBLE CAUSE	WHAT TO DO
Dishwasher doesn't run	<ul style="list-style-type: none"> Fuse blown or the circuit breaker acted. 	<ul style="list-style-type: none"> Replace fuse or reset circuit breaker. Remove any other appliances sharing the same circuit with the dishwasher.
	<ul style="list-style-type: none"> Power supply is not turned on. 	<ul style="list-style-type: none"> Make sure the dishwasher is turned on and the door is closed securely. Make sure the power cord is properly plugged into the wall socket.
	<ul style="list-style-type: none"> Water pressure is low. 	<ul style="list-style-type: none"> Check that the water supply is connected properly and the water is turned on.
Drain pump doesn't stop	<ul style="list-style-type: none"> Overflow. 	<ul style="list-style-type: none"> The system is designed to detect an overflow. When it does, it shuts off the circulation pump and turns on the drain pump.
Noise	<ul style="list-style-type: none"> Some audible sounds are normal. 	<ul style="list-style-type: none"> Sound from soft food shredding action and detergent cup opening.
	<ul style="list-style-type: none"> Utensils are not secure in the baskets or something small has dropped into the basket. 	<ul style="list-style-type: none"> To ensure everything is secured in the dishwasher.
	<ul style="list-style-type: none"> Motor hums. 	<ul style="list-style-type: none"> Dishwasher has not been used regularly. If you do not use it often, remember to set it to fill and pump out every week, which will help keep the seal moist.
Suds in the tub	<ul style="list-style-type: none"> Improper detergent. 	<ul style="list-style-type: none"> Use only the special dishwasher detergent to avoid suds. If this occurs, open the dishwasher and let suds evaporate. Add 1 gallon of cold water to the tub. Close and latch the dishwasher, then start the "soak" wash cycle to drain out the water. Repeat if necessary.
	<ul style="list-style-type: none"> Spilled rinse agent. 	<ul style="list-style-type: none"> Always wipe up rinse agent spills immediately.
Stained tub interior	<ul style="list-style-type: none"> Detergent with colorant was used. 	<ul style="list-style-type: none"> Make sure that the detergent is the one without colorant.
Dishes are not dried	<ul style="list-style-type: none"> Rinse agent dispenser is empty. 	<ul style="list-style-type: none"> Make sure that the rinse agent dispense is filled.
Dishes and flatware not clean	<ul style="list-style-type: none"> Improper program. 	<ul style="list-style-type: none"> Select a more intensive wash program.
	<ul style="list-style-type: none"> Improper rack loading. 	<ul style="list-style-type: none"> Make sure that the action of the detergent dispenser and spray arms are not blocked by large dishware.

Troubleshooting

PROBLEM	POSSIBLE CAUSE	WHAT TO DO
Spots and filming on glasses and flatware	<ol style="list-style-type: none"> 1. Extremely hard water. 2. Low inlet temperature. 3. Overloading the dishwasher. 4. Improper loading. 5. Old or damp powder detergent. 6. Empty rinse agent dispenser. 7. Incorrect dosage of detergent. 	<p>To remove spots from glassware:</p> <ol style="list-style-type: none"> 1. Take out all metal utensils out of the dishwasher. 2. Do not add detergent. 3. Choose the longest cycle. 4. Start the dishwasher and allow it to run for about 18 to 22 minutes, then it will be in the main wash. 5. Open the door to pour 2 cups of white vinegar into the bottom of the dishwasher. 6. Close the door and let the dishwasher complete the cycle. If the vinegar does not work: Repeat as above, except use 1/4 cup (60 ml) of citric acid crystals instead of vinegar.
Cloudiness on glassware	<ul style="list-style-type: none"> • Combination of soft water and too much detergent. 	<ul style="list-style-type: none"> • Use less detergent if you have soft water and select a shortest cycle to wash the glassware and to get them clean.
Yellow or brown film on inside surfaces	<ul style="list-style-type: none"> • Tea or coffee stains. 	<ul style="list-style-type: none"> • Using a solution of 1/2 cup of bleach and 3 cups warm water to remove the stains by hand. <p>⚠ WARNING: You have to wait for 20 minutes after a cycle to let the heating elements cool down before cleaning interior; Failing to follow this instruct may result in the risk of burns.</p>
White film on inside surface	<ul style="list-style-type: none"> • Hard water minerals. 	<ul style="list-style-type: none"> • To clean the interior, use a damp sponge with dishwasher detergent and wear rubber gloves. Never use any other cleaner than dishwasher detergent for the risk of foaming or suds.
Detergent cup lid won't latch	<ul style="list-style-type: none"> • Dial is not in the OFF position. 	<ul style="list-style-type: none"> • Turn the Dial to OFF position and slide the door latch to the left.
Detergent left in dispenser cups	<ul style="list-style-type: none"> • Dishes block detergent cups. 	<ul style="list-style-type: none"> • Re-loading the dishes properly.
Steam	<ul style="list-style-type: none"> • Normal phenomenon. 	<ul style="list-style-type: none"> • There is some steam coming through the vent by the door latch during drying and water draining.
Black or gray marks on dishes	<ul style="list-style-type: none"> • Aluminum utensils have rubbed against dishes. 	<ul style="list-style-type: none"> • Use a mild abrasive cleaner to eliminate those marks.
Water standing in the bottom of the tub	<ul style="list-style-type: none"> • This is normal. 	<ul style="list-style-type: none"> • A small amount of clean water around the outlet on the tub bottom keeps the water seal lubricated.

PROBLEM	POSSIBLE CAUSE	WHAT TO DO
Dishwasher leaks	<ul style="list-style-type: none"> • Overfill dispenser or rinse aid spills. 	<ul style="list-style-type: none"> • Be careful not to overfill the rinse aid dispenser. Spilled rinse aid could cause overusing and lead to overflowing. Wipe away any spills with a damp cloth.
	<ul style="list-style-type: none"> • Dishwasher isn't level. 	<ul style="list-style-type: none"> • Make sure the dishwasher is level.
Buttons are not working on power on state	<ul style="list-style-type: none"> • Door is open. 	<ul style="list-style-type: none"> • When door is opened, buttons are not working except POWER button. Close the door and press the button.
	<ul style="list-style-type: none"> • Child lock function is selected. 	<ul style="list-style-type: none"> • When selected Child lock function, buttons are not responded. To unlock this function, hold down both the Multi in 1 and Delay start buttons for three (3) seconds. Also, Child lock function is released when power cord is reconnected.



The result of washing performance may be caused by a power supply issue. Try another program before contacting for service.

Troubleshooting

ERROR CODES

If an error occurs an error code may be displayed to inform you:

CODES	MEANING	POSSIBLE CAUSES
4E	Water supply error	Inlet water continually for 4 minutes in any case or no water in normal water inlet step. Over 2 L inletting except water inlet step. <ul style="list-style-type: none">• If water inletting below low level quantity at step when heater work, heater is not work by safety device.• If water inletting over low level quantity at any step, heater is controlled by thermister.
HE	Heater error	Heating continually for 60 minutes, yet still not arrive the anticipated temperature. The water level is low in the tub
LE	Leakage error	If the leakage switch is on for 2 seconds. When power S/W is off, LE error is not occurred when happen the leakage on off-state, but if the door is closed, the washer can drain away the water automatically when happen the leakage on off-state.
tE	Failure of temperature sensor	Abnormal of the thermistor (short circuit/open circuit)

 **WARNING:** If overflow occurs, turn off the main water supply before calling a service. If there is water in the base pan because of an over fill or small leak, the water should be removed before restarting the dishwasher.

Appendix

SPECIFICATIONS

Model	DW60H6050FW / DW60H6050FS
Type	Freestanding Dishwasher
Power	220 - 240 V / 50 Hz AC only
Water pressure	0.04 ~ 1.0 MPa
Rated power usage	1760 - 2100 W
Hot water connection	Max 60 °C
Dry type	Condensed dry system
Wash type	Rotating nozzle spray
Dimensions	598 x 600 x 845 mm (Width x Depth x Height)
Weight	Unpacked 51 kg

PRODUCT DIMENSION

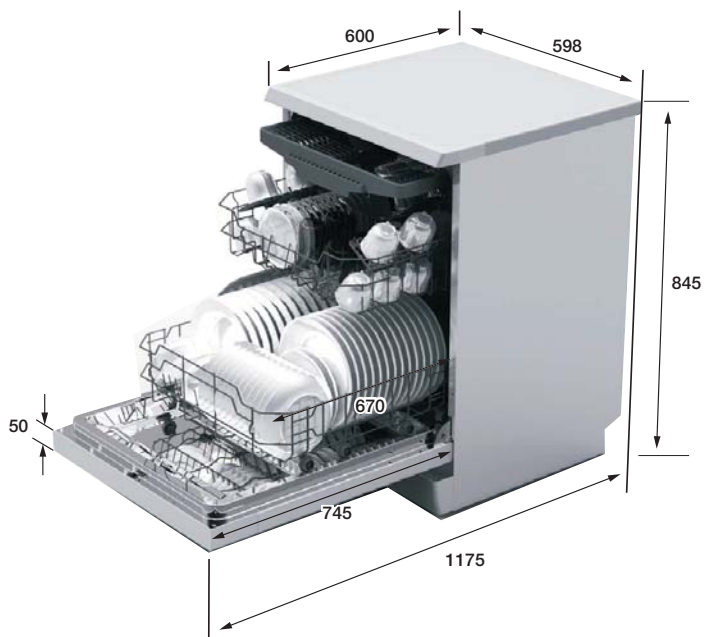

For standard test

 The information for comparability test in accordance with AS/NZS 2007.1 AS follows:
The diagrams below show the proper way to load the baskets based on the Australia Standard (AS/NZS 2007.1)

- Washing capacity: 14 place setting
- Test standard: AS/NZS 2007.1
- Position of upper basket: to lower position
- Wash cycle: Normal
- Additional options: None
- Rinse aid setting: 3
- Dosage of the standard detergent: pre/wash 5 g + main/wash 27.5 g
- For the arrangement of the items, refer below figures

<Upper basket>

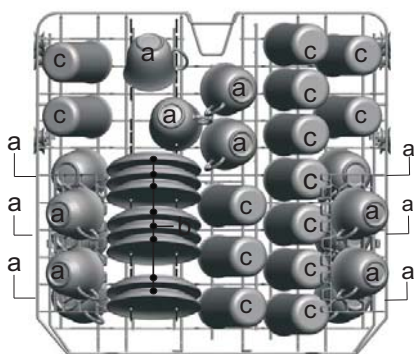



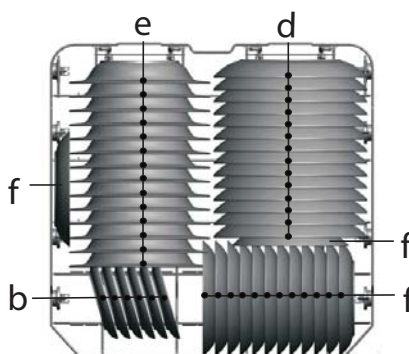

<Lower basket>



<Silverware basket>



1	Forks	
2	Soup spoons	
3	Dessert spoons	
4	Teaspoons	
5	Knives	

Terminology for dishwasher

1. Circulation Motor	A motor that sucks the water remaining on the floor of the dishwasher and injects water using high pressure through the internal water passages to the top Middle and lower nozzles.
2. Drain Pump	The pump that drains the polluted water from the dishwasher generated while the dishwasher is running.
3. Heater	The heater is located on the water passages inside the dishwasher. It heats the flowing water to increase wash efficiency.
4. Flow Meter	Measure the amount of supplied water by counting the pulses of the hall IC located at the next of the inlet valve.
5. Distributor	Located at the output end of the sump inside the dishwasher. It turns the flow of the water that goes to the bottom part of the dishwasher on or off. (This model does not have this part)
6. Dispenser	The location where the detergent and rinse aids are stored so they can be used by the dishwasher. The dispenser automatically supplies detergent and rinse aids to the inside of the dishwasher when they are needed.
7. Tub Assy	An internal case made of stainless steel that makes up the basic framework of the dishwasher.
8. Sump Assy	The place inside the dishwasher where water is collected. The injected water gathers here after circulation. The sump Assy is connected to the circulation motor and drain pump.
9. Tub Front Assy	An internal case made of stainless steel that makes up internal part of the front door.
10. Base Assy	A plastic part that makes up the basic bottom framework.
11. Basket Assy	The upper and lower racks where dishes can be loaded.
12. Middle/Lower Nozzles	Washes dishes by rotating and injecting the supplied water through the water passage at high pressure.
13. Case Brake	A passage that adjusts the air pressure by connecting the pressure of the inside air which is expanded at high temperature during wash and rinse cycles and the outside air pressure.
14. Door Lock Switch	Detects whether the door of the dishwasher is open or closed if the door is open while the dishwasher is running the cycle is temporary stopped.

Note

Note



QUESTIONS OR COMMENTS

COUNTRY	CALL	OR VISIT US ONLINE AT
AUSTRALIA	1300 362 603	www.samsung.com/au/support