

# MaxiCOM MK900



## Trademarks

Autel®, MaxiSys®, MaxiDAS®, MaxiPRO®, MaxiRecorder®, MaxiCOM®, MaxiTPMS®, and MaxiCheck® are trademarks of Autel Intelligent Technology Corp., Ltd., registered in China, the United States, and other countries. All other marks are trademarks or registered trademarks of their respective holders.

## Copyright Information

No part of this manual may be reproduced, stored in a retrieval system or transmitted in any form or by any means electronic, mechanical, photocopying, recording, or otherwise without the prior written permission of Autel.

## Disclaimer of Warranties and Limitation of Liabilities

All information, specifications and illustrations in this manual are based on the latest information available at the time of printing.

Autel reserves the right to make changes at any time without notice. While information of this manual has been carefully checked for accuracy, no guarantee is given for the completeness and correctness of the contents, including but not limited to the product specifications, functions, and illustrations.

Autel will not be liable for any direct, special, incidental, or indirect damages, or for any economic consequential damages (including the loss of profits) as a result of using this product.

---

### **IMPORTANT**

Before operating or maintaining this unit, please read this manual carefully, paying extra attention to the safety warnings and precautions.

---

## For Services and Support



[pro.autel.com](http://pro.autel.com)

[www.autel.com](http://www.autel.com)



+86 (0755) 8614-7779

## Safety Information

For your own safety and the safety of others, and to prevent damage to the device and vehicles upon which it is used, it is important that the safety instructions presented throughout this manual be read and understood by all persons operating or coming into contact with the device.

There are various procedures, techniques, tools, and parts required for servicing vehicles, as well as the skills of the person doing the work. Because of the vast number of test applications and variations in the products that can be tested with this equipment, we cannot possibly anticipate or provide advice or safety messages to cover every circumstance. It is the automotive technician's responsibility to be knowledgeable of the system being tested. It is crucial to use proper service methods and test procedures. It is essential to perform tests in an appropriate and acceptable manner that does not endanger your safety, the safety of others in the work area, the device being used, or the vehicle being tested.

Before using the device, always refer to and follow the safety messages and applicable test procedures provided by the manufacturer of the vehicle or equipment being tested. Use the device only as described in this manual. Be sure to read, understand, and follow all safety messages and instructions in this manual.

## Safety Messages

Safety messages are provided to help prevent personal injury and equipment damage. All safety messages are introduced by a signal word indicating the hazard level.

---

### **DANGER**

Indicates an imminently hazardous situation which, if not avoided, will result in death or serious injury to the operator or to bystanders.

---

### **WARNING**

Indicates a potentially hazardous situation which, if not avoided, could result in death or serious injury to the operator or to bystanders.

---

## Safety Instructions

The safety messages herein cover situations Autel is aware of at the time of publication. Autel cannot know, evaluate or advise you as to all of the possible hazards. You must be certain that any condition or service procedure encountered does not jeopardize your personal safety.

---

 **DANGER**

When an engine is operating, keep the service area WELL VENTILATED or attach a building exhaust removal system to the engine exhaust system. Engines produce carbon monoxide, an odorless, poisonous gas that causes slower reaction time and can lead to serious personal injury or loss of life.

---

 **SAFETY WARNINGS**

- Always perform automotive testing in a safe environment.
- Wear safety eye protection that meets ANSI standards.
- Keep clothing, hair, hands, tools, test equipment, etc. away from all moving or hot engine parts.
- Operate the vehicle in a well-ventilated work area, for exhaust gases are poisonous.
- Put the transmission in PARK (for automatic transmission) or NEUTRAL (for manual transmission) and make sure the parking brake is engaged.
- Put blocks in front of the drive wheels and never leave the vehicle unattended while testing.
- Be extra cautious when working around the ignition coil, distributor cap, ignition wires and spark plugs. These components create hazardous voltages when the engine is running.
- Keep a fire extinguisher suitable for gasoline, chemical, and electrical fires nearby.
- Do not connect or disconnect any test equipment while the ignition is on or the engine is running.
- Keep the test equipment dry, clean, free from oil, water or grease. Use a mild detergent on a clean cloth to clean the outside of the equipment as necessary.
- Do not drive the vehicle and operate the test equipment at the same time. Any distraction may cause an accident.
- Refer to the service manual for the vehicle being serviced and adhere to all diagnostic procedures and precautions. Failure to do so may result in personal injury or damage to the test equipment.
- To avoid damaging the test equipment or generating false data, make sure the vehicle battery is fully charged and the connection to the vehicle DLC is clean and secure.
- Do not place the test equipment on the distributor of the vehicle. Strong electro-magnetic interference can damage the equipment.

# CONTENTS

<b>1 USING THIS MANUAL</b> .....	<b>1</b>
1.1 CONVENTIONS .....	1
1.1.1 Bold Text.....	1
1.1.2 Notes and Important Messages .....	1
1.1.3 Hyperlinks .....	1
1.1.4 Illustrations.....	2
1.1.5 Procedures.....	2
<b>2 GENERAL INTRODUCTION</b> .....	<b>3</b>
2.1 MAXICOM MK900 TABLET .....	3
2.1.1 Product Overview.....	3
2.1.2 Power Sources.....	5
2.1.3 Technical Specifications.....	5
2.2 OTHER ACCESSORIES .....	6
<b>3 GETTING STARTED</b> .....	<b>8</b>
3.1 POWER UP.....	8
3.1.1 Application Buttons .....	9
3.1.2 Locator and Navigation Buttons .....	10
3.1.3 System Status Icons .....	11
3.2 POWER DOWN.....	11
3.2.1 Reboot System .....	11
<b>4 DIAGNOSTICS</b> .....	<b>12</b>
4.1 GETTING STARTED.....	12
4.1.1 Vehicle Menu Layout .....	12
4.2 VEHICLE IDENTIFICATION.....	14

4.2.1	Auto Detect .....	14
4.2.2	Manual Input .....	15
4.2.3	Scan VIN/License .....	15
4.2.4	Manual Vehicle Section.....	16
4.2.5	OBDII Direct Entry .....	16
4.3	NAVIGATION .....	17
4.3.1	Diagnostics Screen Layout .....	17
4.3.2	Screen Messages .....	19
4.3.3	Making Selections.....	20
4.4	DIAGNOSTIC FUNCTIONS.....	20
4.4.1	ECU Information .....	23
4.4.2	Trouble Codes .....	24
4.4.3	Live Data.....	25
4.4.4	Active Test .....	32
4.4.5	Special Functions.....	33
4.5	GENERIC OBDII OPERATIONS.....	33
4.5.1	General Procedure.....	33
4.5.2	Function Descriptions.....	34
4.6	DIAGNOSTIC REPORTS .....	36
4.6.1	Pre-Scan and Post-Scan Functions .....	36
4.6.2	Diagnostics Report Saving, Viewing, and Sharing .....	37
4.7	EXITING DIAGNOSTICS .....	41
<b>5</b>	<b>SERVICE .....</b>	<b>43</b>
5.1	OIL RESET SERVICE.....	43
5.2	ELECTRONIC PARKING BRAKE (EPB) SERVICE .....	43
5.2.1	EPB Safety.....	44

5.3	BATTERY MANAGEMENT SYSTEM (BMS) SERVICE .....	44
5.4	STEERING ANGLE SENSOR (SAS) SERVICE.....	45
5.5	DIESEL PARTICLE FILTER (DPF) SERVICE .....	45
5.6	TIRE PRESSURE MONITOR SYSTEM (TPMS) SERVICE.....	46
<b>6</b>	<b>DATA MANAGER .....</b>	<b>47</b>
6.1	VEHICLE HISTORY .....	48
6.1.1	Historical Test Record.....	49
6.2	WORKSHOP INFORMATION .....	50
6.3	CUSTOMER.....	51
6.4	IMAGE.....	52
6.5	CLOUD REPORT.....	53
6.6	PDF FILES.....	53
6.7	REVIEW DATA.....	54
6.8	DATA LOGGING.....	54
6.9	UNINSTALL APPS .....	54
<b>7</b>	<b>SETTINGS.....</b>	<b>55</b>
7.1	UNIT.....	55
7.2	LANGUAGE .....	56
7.3	PRINTING SETTINGS .....	56
7.3.1	Printing Operations .....	56
7.4	REPORT SETTINGS.....	57
7.5	PUSH NOTIFICATIONS .....	58
7.6	FIRMWARE UPGRADE .....	58
7.7	AUTO UPDATE .....	59
7.8	VEHICLE LIST.....	60
7.9	SYSTEM SETTINGS.....	60

7.10	ABOUT .....	60
<b>8</b>	<b>UPDATE .....</b>	<b>61</b>
<b>9</b>	<b>REMOTE DESKTOP .....</b>	<b>62</b>
<b>10</b>	<b>SUPPORT .....</b>	<b>64</b>
10.1	SUPPORT SCREEN LAYOUT .....	64
10.2	MY ACCOUNT.....	64
10.3	DATA LOGGING .....	65
10.4	TRAINING.....	65
10.5	FAQ .....	65
<b>11</b>	<b>QUICK LINK.....</b>	<b>66</b>
<b>12</b>	<b>MAXVIEWER.....</b>	<b>67</b>
<b>13</b>	<b>MAXIVIDEO.....</b>	<b>70</b>
<b>14</b>	<b>AUTEL USER CENTER .....</b>	<b>71</b>
<b>15</b>	<b>MAINTENANCE AND SERVICE .....</b>	<b>73</b>
15.1	MAINTENANCE INSTRUCTIONS.....	73
15.2	TROUBLESHOOTING CHECKLIST .....	73
15.3	ABOUT BATTERY USAGE .....	74
15.4	SERVICE PROCEDURES.....	75
15.4.1	Technical Support .....	75
15.4.2	Repair Service.....	75
15.4.3	Other Services.....	76
<b>16</b>	<b>COMPLIANCE INFORMATION.....</b>	<b>77</b>
<b>17</b>	<b>WARRANTY .....</b>	<b>79</b>
17.1	LIMITED ONE YEAR WARRANTY .....	79

# 1 Using this Manual

This manual contains device usage instructions.

Some illustrations shown in this manual may make reference to modules and optional equipment that are not included in your system. Contact your sales representative for availability of other modules and optional tools or accessories.

## 1.1 Conventions

---

The following conventions are used:

### 1.1.1 Bold Text

Bold text is used to highlight selectable items such as buttons and menu options.

Example:

- Tap **OK**.

### 1.1.2 Notes and Important Messages

#### 1.1.2.1 *Notes*

A **NOTE** provides helpful information such as additional explanations, tips, and comments.

#### 1.1.2.2 *Important*

**IMPORTANT** indicates a situation which, if not avoided, may result in damage to the test equipment or vehicle.

### 1.1.3 Hyperlinks

Hyperlinks are available in electronic documents. Blue italic text indicates a selectable hyperlink; blue underlined text indicates a website link or an email address link.

## 1.1.4 Illustrations

Illustrations used in this manual are samples; the actual testing screen may vary for each vehicle being tested. Observe the menu titles and on-screen instructions to make correct option selection.

## 1.1.5 Procedures

An arrow icon indicates a procedure.

Example:

➤ **To power down the tablet**

1. Long press the **Power/Lock** button.
2. Tap **Power off**. The tablet will turn off in a few seconds.

# 2 General Introduction

This manual describes the construction and operation of the device and how it works to deliver diagnostic solutions.

## 2.1 MaxiCOM MK900 Tablet

---

### 2.1.1 Product Overview

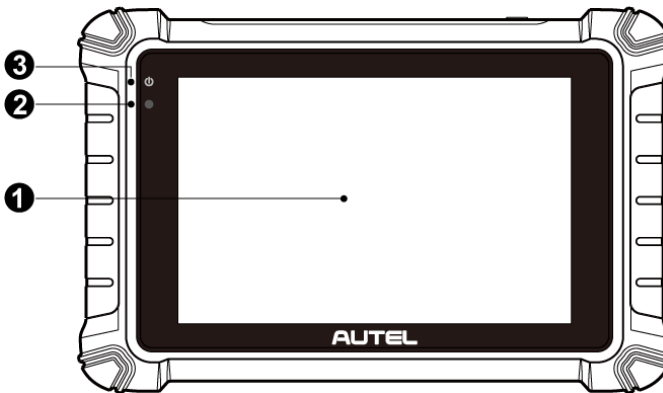

**Figure 2-1 Tablet Front View**

1. 8.0" LCD Capacitive Touchscreen
2. Ambient Light Sensor — detects ambient brightness.
3. Power LED — indicates battery level & charging or system status.

The power LED displays green, yellow or red depending on power level and operating status.

A. Green

- Illuminates green when the tablet is charging and the battery level is above 90%.
- Illuminates green when the tablet is powered on and the battery level is above 15%.

B. Yellow

- Illuminates yellow when the tablet is charging and the battery level is below 90%.

C. Red

- Illuminates red when the tablet is powered on and the battery level is below 15% or an error has occurred.

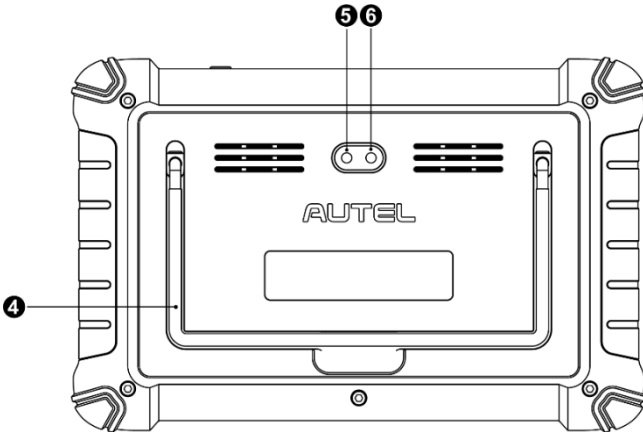

**Figure 2-2 Tablet Back View**

4. Collapsible Stand — extends from the back to allow hands-free viewing of the tablet.
5. Rear Camera
6. Camera Flash

**Camera**

**Function Description:** Used for vehicle information identification, such as VIN scanning and vehicle photography.

**Privacy Impact:** Collects vehicle VIN data and uploads it to the cloud platform to identify the vehicle model, year, engine type, etc.

**Permission Control:** Camera access permissions can be disabled in system settings (Path: Settings > System Settings > Privacy > Permission Manager > Camera).

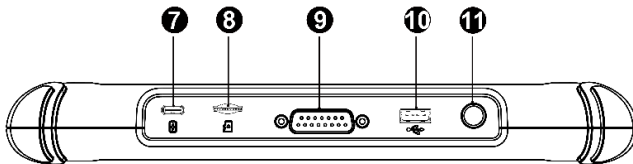

**Figure 2-3 Tablet Top View**

7. USB Type-C Charging Port
8. Mini SD Card Slot
9. DB15-Pin Port — connects the main cable.
10. USB Port
11. Power/Lock Button — press and hold to turn the device on/off, or tap to lock the screen.

## 2.1.2 Power Sources

The tablet can receive power from any of the following sources:

- Internal battery pack
- Vehicle power
- External power supply

### 2.1.2.1 Internal Battery Pack

The tablet can be powered via the internal rechargeable battery, which if fully charged can provide sufficient power for about 7 hours of continuous use.

### 2.1.2.2 Vehicle Power

When the tablet is connected to the vehicle via the main cable, the tablet automatically receives power from the vehicle.

### 2.1.2.3 External Power Supply

The tablet can be powered from a wall socket using the included USB type-C cable and power adapter. The external power supply also charges the internal battery pack.

## 2.1.3 Technical Specifications

**Table 2-1 Specifications**

Item	Description
<b>Recommended Use</b>	Indoor
<b>Operating System</b>	Android 11
<b>Processor</b>	Quad-core processor
<b>Memory</b>	64 GB
<b>Display</b>	8-inch LCD touchscreen with 1280 x 800 resolution

Item	Description
<b>Connectivity</b>	<ul style="list-style-type: none"> <li>● Type-C USB</li> <li>● USB 2.0</li> <li>● Wi-Fi</li> <li>● Micro SD card (supports up to 64 GB)</li> </ul>
<b>Sensor</b>	Ambient light sensor
<b>Audio Input/Output</b>	<ul style="list-style-type: none"> <li>● Input: N/A</li> <li>● Output: buzzer</li> </ul>
<b>Power and Battery</b>	<ul style="list-style-type: none"> <li>● 3.7 V/7700 mAh lithium-polymer battery</li> <li>● Charges via 5 V DC power supply</li> </ul>
<b>Tested Battery Life</b>	Around 7 hours of continuous use
<b>Battery Charging Input</b>	5 V/3 A
<b>Power Consumption</b>	Approx. 600 mA (LCD on with default brightness, Wi-Fi on) @ 3.7 V
<b>Operating Temp.</b>	0 to 50 °C (32 to 122 °F)
<b>Storage Temp.</b>	-10 to 60 °C (14 to 140 °F)
<b>Operating Humidity</b>	5 % to 95 % non-condensing
<b>Dimensions (W x H x D)</b>	168.9 mm (6.6") x 259.8 mm (10.2") x 33.6 mm (1.3")
<b>Net Weight</b>	925 g (2.04 lbs.)
<b>Supported Automotive Protocols</b>	ISO9141-2, ISO14230-2, ISO15765, K/L-Line, Flashing Code, SAE-J1850 VPW, SAE-J1850 PWM, ISO11898 (High-speed, Middle-speed, Low-speed and Single-wire CAN, fault-tolerant CAN), SAE J2610, GM UART, UART Echo Byte Protocol, Honda Diag-H Protocol, TP2.0, TP1.6, ISO13400, CAN FD

## 2.2 Other Accessories

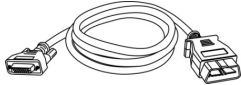
	<p><b>Main Cable</b> Connects the tablet to the vehicle's OBDII port (DLC).</p>
---	---

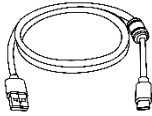

**USB Type-C Cable**

Use with the power adapter to provide power supply to the tablet.

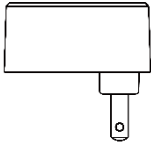

**Power Adapter**

Together with the USB type-C cable, connects the tablet to the external DC power port for power supply.

# 3 Getting Started

Ensure the tablet is sufficiently charged or is connected to an external power supply (see [Power Sources](#)).

## 3.1 Power Up

Press and hold the **Power/Lock** button on the top-right of the tablet to power on the unit. The power LED will illuminate green. The system boots up and displays the lock screen. Slide the Lock icon up to unlock.

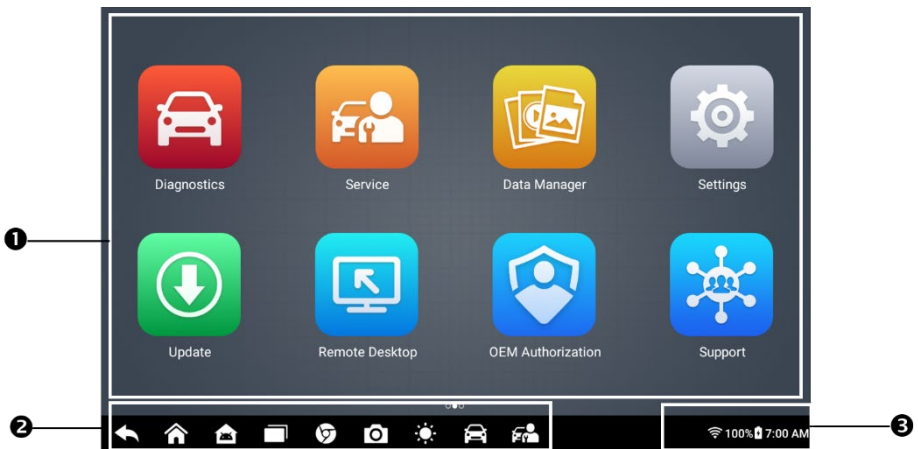

**Figure 3-1 MaxiCOM Job Menu**

1. Application Buttons
2. Locator and Navigation Buttons
3. Status Icons

### NOTE









The tablet screen is locked by default when first powered on. We recommend you lock the screen to protect the information in the system and conserve the power.





The touchscreen navigation is menu-driven, which allows you to quickly locate the test procedure or data that you need through a series of questions and options. Detailed descriptions of the menu items can be found in the application chapters.

### 3.1.1 Application Buttons

Descriptions of the tool applications are displayed in the table below.

**Table 3-1 Applications**





Button	Name	Description
	<b>Diagnostics</b>	Accesses the unit's diagnostic functions. See <a href="#">Diagnostics</a> .
	<b>Service</b>	Accesses special functions menu. See <a href="#">Service</a> .
	<b>Data Manager</b>	Accesses the saved repair shop, customer and vehicle data including detailed vehicle diagnostics and test records. See <a href="#">Data Manager</a> .
	<b>Settings</b>	Accesses the system settings menu and general tablet menu. See <a href="#">Settings</a> .
	<b>Update</b>	Accesses system software update menu. See <a href="#">Update</a> .
	<b>Remote Desktop</b>	Configures your unit to receive remote support using the TeamViewer application. See <a href="#">Remote Desktop</a> .
	<b>OEM Authorization</b>	Manages the permissions for unlocking the OE gateway.
	<b>Support</b>	Synchronizes Autel's online service database with the MaxiCOM tablet. See <a href="#">Support</a> .





Button	Name	Description
	<b>Quick Link</b>	Provides associated website bookmarks to allow quick access to product update, service, support, and other information. See <a href="#">Quick Link</a> .
	<b>MaxiViewer</b>	Provides a quick search for supported functions and/or vehicles. See <a href="#">MaxiViewer</a> .
	<b>MaxiVideo</b>	Configures the tablet to operate as a video scope by connecting to an imager head cable for close vehicle inspections. See <a href="#">MaxiVideo</a> .
	<b>Autel User Center</b>	Allows you to register an account, view and edit your personal profile and link your device. See <a href="#">Autel User Center</a> .

### 3.1.2 Locator and Navigation Buttons

Operations of the Navigation buttons at the bottom of the screen are described in the table below:

**Table 3-2 Locator and Navigation Buttons**

Button	Name	Description
	<b>Locator</b>	Indicates the location of the current screen. Swipe left or right to view the previous or next screen.
	<b>Back</b>	Returns to the previous screen.
	<b>MaxiCOM Home</b>	Returns to the MaxiCOM Job Menu.
	<b>Android Home</b>	Returns to the Android system Home screen.
	<b>Recent Apps</b>	Displays a list of applications that are currently running. Tap an app icon to launch. Close an app by swiping it to the top.

Button	Name	Description
	<b>Chrome</b>	Launches the Google Chrome browser.
	<b>Camera</b>	Tap the Camera icon to open camera viewfinder. Press and hold the icon to take a screenshot of the current screen. The saved files are saved in the Data Manager application for later review. See <a href="#">Data Manager</a> for details.
	<b>Display Brightness</b>	Automatically adjusts the display brightness.
	<b>Diagnostic Shortcut</b>	Returns to the Diagnostics screen.
	<b>Service Shortcut</b>	Returns to the Service screen.

### 3.1.3 System Status Icons

As the tablet is working with the Android operating system, you may refer to Android documents for more information.

## 3.2 Power Down

---

All vehicle communications should be terminated before shutting down the tablet. A warning message displays if a shutdown is attempted while the tablet is communicating with the vehicle. Forcing a shutdown while the tablet is communicating with the vehicle may lead to ECU problems on some vehicles. Please exit the Diagnostics application before powering down.

#### ➤ To power down the tablet

1. Long press the **Power/Lock** button.
2. Tap **Power Off**. The tablet will turn off in a few seconds.

### 3.2.1 Reboot System

In case of a system crash, press and hold the **Power/Lock** button and tap **Restart** to restart the system.

# 4 Diagnostics

The Diagnostics application can access the electronic control unit (ECU) for various vehicle control systems, including engine, transmission, antilock brake system (ABS), and airbag system (SRS).

## 4.1 Getting Started

Prior to first using of the Diagnostics application, ensure a communication link is established between the tablet and the test vehicle via the main cable.

### 4.1.1 Vehicle Menu Layout

When the tablet is properly connected to the vehicle, the platform is ready to start vehicle diagnosis. Tap the **Diagnostics** application button on the MaxiCOM Job Menu to access the Vehicle Menu.





**Figure 4-1 Vehicle Menu Screen**

1. Top Toolbar Buttons
2. Manufacturer Buttons

#### 4.1.1.1 Top Toolbar Buttons

The operations of the toolbar buttons at the top of the screen are listed and described in the table below:

**Table 4-1 Top Toolbar Buttons**

Button	Name	Description
	<b>Home</b>	Returns to the MaxiCOM Job Menu.
	<b>VID</b>	Tap to display a dropdown list: <ul style="list-style-type: none"> <li>● Tap <b>Auto Detect</b> for auto VIN detection.</li> <li>● Tap <b>Manual Input</b> to enter VIN manually.</li> <li>● Tap <b>Scan VIN/License</b> to scan the vehicle's VIN or license number.</li> </ul>
	<b>All</b>	Displays all the vehicle makes in the vehicle menu.
	<b>Favorites</b>	Adds your preferred vehicle manufacturers into favorites.
	<b>History</b>	Displays stored test vehicle records. See <a href="#">Vehicle History</a> .
	<b>America</b>	Displays vehicles from U.S. automakers.
	<b>Europe</b>	Displays vehicles from European automakers.
	<b>Asia</b>	Displays vehicles from Asian automakers.
	<b>China</b>	Displays vehicles from Chinese automakers.
	<b>Search</b>	Tap the search field to show a virtual keyboard and enter a vehicle manufacturer name.
	<b>Cancel</b>	Tap to exit the search screen or cancel an operation.

#### 4.1.1.2 Vehicle Manufacturer Buttons

The Manufacturer Buttons list available vehicle brands for testing. Select the manufacturer button after the tablet is properly connected to the test vehicle to start a diagnostics session.

## 4.2 Vehicle Identification

The MaxiCOM diagnostics system supports five methods of Vehicle Identification.

1. Auto Detect
2. Manual Input
3. Scan VIN/License
4. Manual Vehicle Selection
5. OBDII Direct Entry

### 4.2.1 Auto Detect

The MaxiCOM diagnostics system features the latest VIN-based Auto Detect function to identify vehicles with just one tap, enabling you to quickly identify the exact vehicle and scan its available systems for fault codes.

#### ➤ To perform Auto Detect

1. Tap the **Diagnostics** button from the MaxiCOM Job Menu. The Vehicle Menu should display.
2. Tap the **VID** button on the top toolbar.



Figure 4-2 Auto VIN Screen

3. Select **Auto Detect**. The tablet starts VIN scanning on the vehicle's ECU. Once the test vehicle is successfully identified, the system will guide you to the vehicle Diagnostics Menu screen. See [Figure 4-4 Diagnostic Menu Screen](#).

## 4.2.2 Manual Input

For vehicles that do not support the Auto Detect function, you may manually enter the vehicle VIN.

### ➤ To perform Manual Input

1. Tap the **Diagnostics** application button from the MaxiCOM Job Menu. The Vehicle Menu displays.
2. Tap the **VID** button on the top toolbar.
3. Select **Manual Input**.
4. Tap the input box and enter the correct VIN code or license number.
5. Tap **OK**. The vehicle will be identified and matched to the vehicle database, and the system will guide you to the vehicle Diagnostics Menu screen.

## 4.2.3 Scan VIN/License

MaxiCOM diagnostic tablet also supports Scan VIN/License function. Enabling this function will automatically turn on the camera. With the help of the camera system, the vehicle's VIN or license number can be easily recognized.

---

### NOTE

The method of scan license is supported in some countries and areas. Please manual input the license number if it is not available.

---

### ➤ To perform Scan VIN/License

1. Tap the **Diagnostics** application button from the MaxiCOM Job Menu. The Vehicle Menu displays.
2. Tap the **VID** button on the top toolbar to open the dropdown list.
3. Select **Scan VIN/License**.
4. The camera will be launched. On the right side of the screen, from top to bottom, three options are available: **Scan QR Code/Barcode**, **Scan VIN**, and **Scan License Number**.
5. Select one of the three options and position the tablet to align the VIN, license number or the barcode within the scanning frame. The scan result will display on the Recognition Result screen. Tap **OK** to confirm the result, and then the vehicle information confirmation screen will display on the tablet.

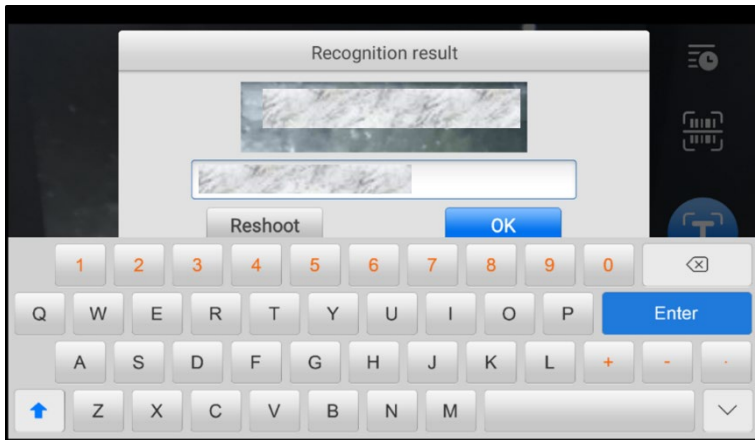

**Figure 4-3 Scan VIN/License**

6. If the VIN or license number cannot be scanned, you can input manually. Tap the  button on the bottom-right corner of the screen to display the screen for manually input. After entering the correct VIN, tap **OK** to continue.
7. Follow the on-screen instructions to complete the operation and advance to the vehicle Diagnostics Menu screen.

## 4.2.4 Manual Vehicle Section

When the vehicle's VIN is not automatically retrievable through the vehicle's ECU, or the specific VIN is unknown, you can select the vehicle manually.

### Step-by-step Vehicle Selection

This mode of vehicle selection is menu-driven. Select a vehicle manufacturer on the Vehicle Menu screen and the Select Diagnostic Type screen displays, then tap the **Manual Selection** button. Select the vehicle information like the Brand, Model, Capacity, Engine type, and Model year on the same screen. The **ESC** button at the lower-right corner of the screen will bring you back to the previous screen. Tap the **Reset** button to reselect the vehicle information if needed.

## 4.2.5 OBDII Direct Entry

Occasionally, the tablet may not be able to identify a vehicle. For these vehicles, the user may perform a generic OBDII or EOBD diagnostic. See [Generic OBDII Operations](#) for additional information.

## 4.3 Navigation

After the test vehicle is identified, the diagnostic menu will appear. This section consists of various commonly used functions, including Auto Scan and Control Unit. The available functions displayed vary depending on the test vehicle.

### 4.3.1 Diagnostics Screen Layout

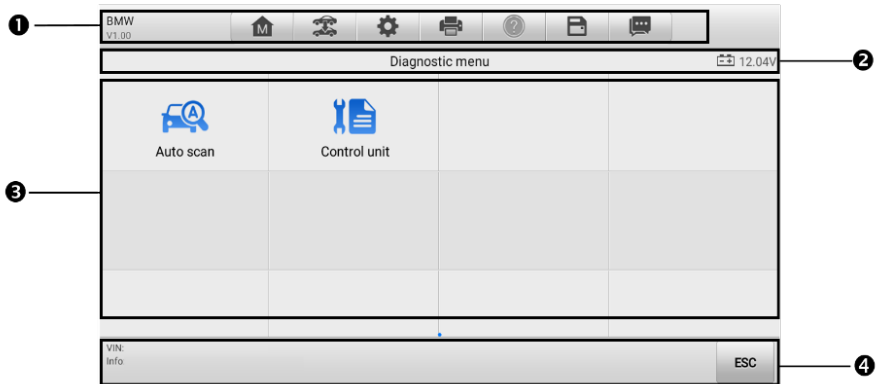

**Figure 4-4 Diagnostic Menu Screen**







The diagnostics screen typically includes four sections.

1. Diagnostics Toolbar
2. Status Information Bar
3. Main Section
4. Function Buttons

#### 4.3.1.1 Diagnostics Toolbar

The Diagnostics Toolbar contains buttons that allow you to print and save the displayed data along with other operations. The table below provides a brief description for the operations of these buttons.

**Table 4-2 Diagnostics Toolbar Buttons**

Button	Name	Description
	<b>Home</b>	Returns to the MaxiCOM Job Menu.
	<b>Vehicle Swap</b>	Exits the diagnostics session of the currently identified test vehicle and returns to the vehicle menu screen.
	<b>Settings</b>	Opens the Settings screen. See <a href="#">Settings</a> .
	<b>Print</b>	Saves and prints a copy of the displayed data. See <a href="#">Printing Settings</a> for additional information.
	<b>Help</b>	Provides instructions or tips for operations of various diagnostics functions.
	<b>Save</b>	Opens a submenu which provides options for data storage.
	<b>Data Logging</b>	Tap to display the error options. Select a specific error type and a submission form will appear to let you enter the report information.

➤ **To print data in Diagnostics**

1. Tap the **Diagnostics** application button from the MaxiCOM Job Menu.
2. Tap **Print** and a drop-down menu displays. The **Print** button on the diagnostics toolbar is available throughout the Diagnostics operations.
  - **Print This Page** — prints a screenshot of the current screen.
  - **Print All Data** — prints a PDF file of all displayed data.
3. A temporary file will be created and sent via the computer to the printer.
4. When the file is transferred successfully, a confirmation message will appear.

➤ **To submit Data Logging reports in Diagnostics**

1. Tap the **Diagnostics** application button from the MaxiCOM Job Menu.
2. Tap the **Data Logging** button to display the error options. The **Data Logging** button on the diagnostics toolbar is available throughout the Diagnostics operations.

3. Select a specific error, and a submission form will appear to let you enter the report information.
4. Tap **Send** to submit the report via the Internet, and a confirmation message will appear when sent successfully.

#### 4.3.1.2 *Status Information Bar*

The Status Information Bar at the top of the Main Section displays the following items:

1. Menu Title — displays the menu heading of the Main Section.
2. Battery Icon — indicates the battery status of the vehicle.

#### 4.3.1.3 *Main Section*

The Main Section varies depending on the stage of operations, which displays vehicle identification selections, the main menu, test data, messages, instructions, and other diagnostics information.

#### 4.3.1.4 *Function Buttons*

The displayed Function Buttons at the bottom of the screen vary by operation. These buttons can be used to navigate menus, save or clear diagnostics data, exit scanning, and perform a number of other control functions. The use of these buttons will be discussed in detail in the following sections of the corresponding test operations.

### 4.3.2 **Screen Messages**

Messages appear when additional input is needed before proceeding. There are three main types of on-screen messages: Confirmation, Warning, and Error.

#### 4.3.2.1 *Confirmation Messages*

Confirmation messages inform you when you are about to perform an action that cannot be reversed or when an action has been initiated and your confirmation is needed to continue.

When a user-response is not required, the message only appears briefly before disappearing.

#### 4.3.2.2 *Warning Messages*

This type of message appears when completing the selected action may result in an irreversible change or loss of data. An example of this message is the “Erase Codes” message.

### 4.3.2.3 Error Messages

Error messages display when a system or procedural error has occurred. Possible errors include cable disconnection and communication interruption.

## 4.3.3 Making Selections

The Diagnostics application is a menu-driven program that presents a series of options one at a time. As you select from a menu, the next menu in the series appears. Each selection narrows the focus and leads to the desired test. Use your fingertip to make menu selections.

## 4.4 Diagnostic Functions

---

The Diagnostics application enables a data link to the electronic control system of the test vehicle for vehicle diagnosis. The application performs functional tests and retrieves vehicle diagnostics information such as trouble and event codes and live data for various vehicle control systems, such as engine, transmission, and ABS.

There are two options available when accessing the Diagnosis section:

1. Auto Scan — starts auto scanning for all the available systems on the vehicle.
2. Control Unit — displays a selection menu of all the available control units of the test vehicle.

After a selection is made and the tablet establishes communication with the vehicle, the corresponding function menu or selection menu displays.

### **Auto Scan**

The Auto Scan function performs a comprehensive scanning over all the ECUs in the vehicle to locate faults and retrieve DTCs.

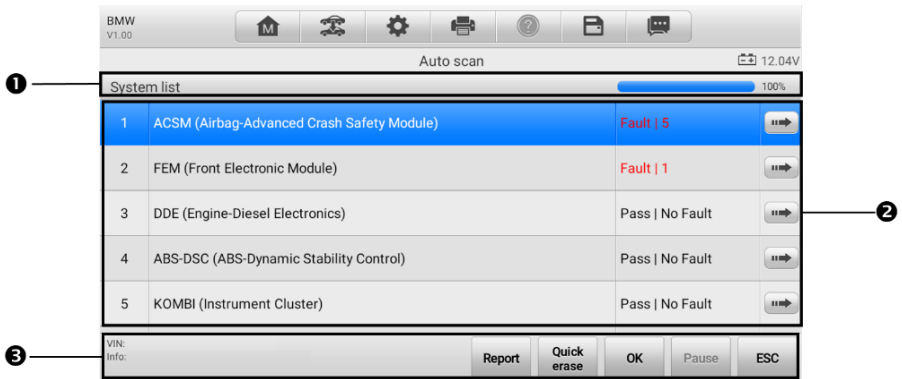

**Figure 4-5 Auto Scan Screen**

1. Navigation Bar
2. Main Section
3. Function Buttons

**Navigation Bar**

List Tab — displays the scanned data in list format.

Progress Bar — indicates the test progress.

**Main Section**

Column 1 — displays the system numbers.

Column 2 — displays the scanned systems.

Column 3 — displays the scan results.

- ❖ **Fault(s) | #:** Fault(s) indicate(s) there is/are detected fault code(s) present; “#” indicates the number of the detected faults.
- ❖ **Pass | No Fault:** Indicates the system has passed the scanning process and no fault has been detected.
- ❖ **Not Scanned:** Indicates the system has not been scanned or the tablet is unable to access this system.

Column 4 — tap to enter the related system and view the detailed information.

**Function Buttons**

The table below provides a brief description of how the function buttons operate:



**Table 4-3 Function Buttons in Auto Scan**

Name	Description
<b>Report</b>	Displays the diagnostics data in a report.
<b>Quick Erase</b>	Erases all fault information after scanning. A warning message will display to inform you of possible data loss when this function is selected.
<b>OK</b>	Confirms the test result. Continues the system diagnosis after the required system is selected by tapping the item in the Main Section.
<b>Pause</b>	Pauses the scanning process, and it will change to <b>Continue</b> button after tapping.
<b>ESC</b>	Returns to the previous screen or exits Auto Scan.

## Control Unit

The Control Unit allows you to manually locate a required control system for testing through a series of choices. Follow the menu-driven procedures and make proper selection, and the program guides you to the proper diagnostic function menu.



**Figure 4-6 Function Menu Screen**

Available functions may vary by vehicle. The function menu may include:

- **ECU Information** — displays detailed ECU information. Select to view the information screen.
- **Trouble Codes** — contains Read Codes and Erase Codes. The former displays detailed DTC information retrieved from the vehicle control module, the latter allows you to erase DTCs and other data from the ECU.
- **Live Data** — retrieves and displays live data and parameters from the vehicle's ECU.
- **Active Test** — accesses vehicle-specific subsystem and components tests.
- **Special Function** — performs various component adaptations.

➤ **To perform a diagnostic function**

1. Establish communication with the test vehicle.
2. Identify the test vehicle by selecting from the menu options.
3. Locate the required system for testing by **Auto Scan** or through menu-driven selections in **Control Unit**.
4. Select the desired diagnostic function from the Function Menu.

## 4.4.1 ECU Information

This function retrieves and displays the specific information for the tested control unit, including unit type, version numbers, and other specifications.

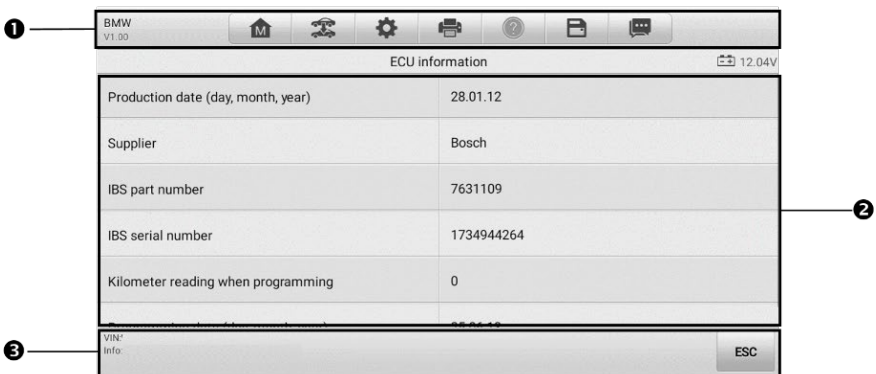

**Figure 4-7 ECU Information Screen**

1. Diagnostics Toolbar Buttons — see [Table 4-2 Diagnostics Toolbar Buttons](#) for detailed descriptions for the operations for each button.
2. Main Section — the left column displays the item names, and the right column shows the specifications or descriptions.
3. Function Button — in this case, only the **ESC** button is available. Tap it to exit after viewing.

## 4.4.2 Trouble Codes

### A. Read Codes

This function retrieves and displays DTCs from the vehicle's control system. The Read Codes screen varies for each vehicle being tested. On some vehicles, freeze frame data can also be retrieved for viewing. A sample Read Codes screen displays as below:

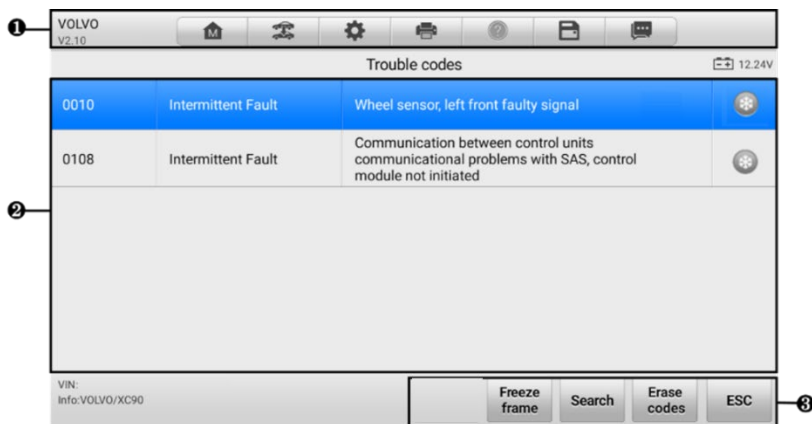

**Figure 4-8 Read Codes Screen**

1. Diagnostics Toolbar — see [Table 4-2 Diagnostics Toolbar Buttons](#) for details.
2. Main Section
  - Column 1 — displays the retrieved codes from the vehicle.
  - Column 2 — indicates the status of the retrieved codes.
  - Column 3 — detailed descriptions for the retrieved codes.
  - Snowflake Icon — only displays when freeze frame data is available for viewing. Tap the icon to display the data screen, which is similar to that of the Read Codes interface and shares similar operations.

### 3. Function Button

- **Freeze Frame** — tap to view the freeze frame data.
- **Search** — tap to search related fault code information on the Internet.
- **Erase Codes** — tap to erase the fault codes.
- **ESC** — tap to return to the previous screen or exit the function.

### B. Erase Codes

After reading the retrieved codes and making repairs, you can erase the codes from the vehicle using this function. Before performing this function, make sure the vehicle's ignition key is in the ON (RUN) position with the engine off.

#### ➤ To erase codes

1. Tap **Erase Codes** from the Trouble Codes screen.
2. A warning message displays to inform you of data loss when this function is applied.
  - a) Tap **Yes** to continue. A confirmation screen displays when the operation is successfully done.
  - b) Tap **No** to exit.
3. Tap **ESC** on the confirmation screen to exit Erase Codes.
4. Perform the Read Codes function again to ensure the operation is successful.

## 4.4.3 Live Data

When this function is selected, the screen displays the data list for the selected module. The parameters display in the order that they are transmitted by the ECU, so expect variation among vehicles.

Gesture scrolling allows you to quickly move through the data list. Drag your finger(s) up or down to reposition the parameters being displayed if the data occupies more than one screen. The figure below shows a typical Live Data screen:

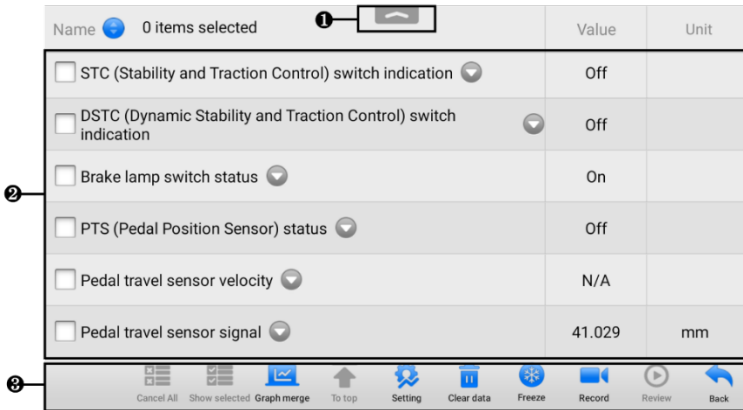

**Figure 4-9 Live Data Screen**

1. Diagnostics Toolbar Buttons — tap the drop-down button at the top center of the screen and the toolbar buttons will display. See [Table 4-2 Diagnostics Toolbar Buttons](#) for details.
2. Main Section
  - Name Column — displays the parameter names.
    - a) Check Box — tap the check box on the left side of the parameter name to make item selection. Tap the check box again to deselect the item.
    - b) Drop-down Button — tap the drop-down button on the right side of the parameter name to open a sub menu, providing data display mode options.
  - Value Column — displays the values of the parameter items.
  - Unit Column — displays the unit for the parameters. (Tap the **Settings** button on the diagnostic toolbar and select a required mode. See [Unit](#) for more information.)
3. Function Buttons — There are many function buttons on the Live Data screen. Detailed descriptions of these buttons are described in the following subsections.

#### A. Display Mode

There are four types of display modes available for data viewing, allowing you to view various types of parameters in the mode best suited to represent the data.

Tap the drop-down button on the right of a parameter to open a submenu. A total of 7 buttons will be displayed: The 4 buttons to the left represent different data display modes, plus an **Information** button (active when additional information is available), a **Unit Change** button (for switching the unit of displayed data), and a **Trigger** button (tap to open the Trigger Settings screen).

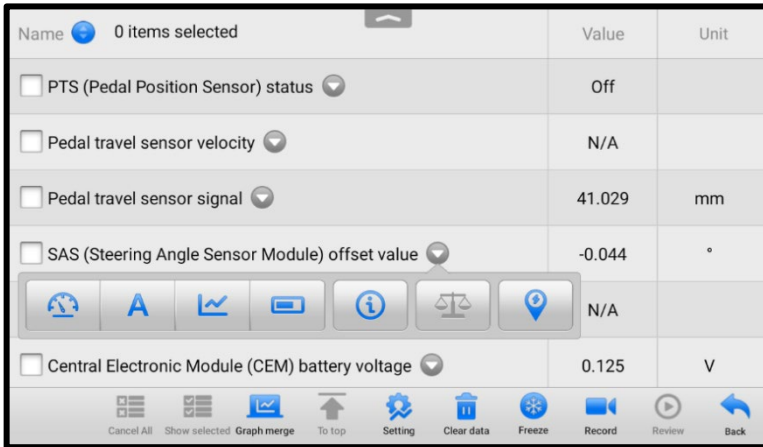

**Figure 4-10 Display Mode Screen**

Each parameter item displays its selected mode independently.

- ◆ **Analog Gauge Mode** — displays the parameters in gauge charts.
- ◆ **Text Mode** — the default mode that displays the parameters as a text list.

**NOTE**

Status parameters, such as a switch reading like ON, OFF, ACTIVE, and ABORT, can only be displayed in Text Mode. Value parameters, such as a sensor reading, can be displayed in both text and graph modes.

- ◆ **Waveform Graph Mode** — displays the parameters in waveform graphs.

In this mode, five control buttons will display on the right side of the parameter item, allowing you to manipulate the display status.

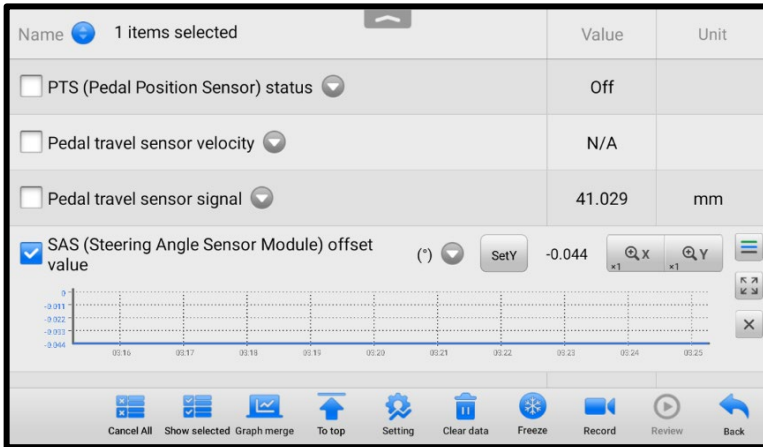

**Figure 4-11 Waveform Graph Mode Screen**

- **Settings Button (SetY)** — sets the minimum and maximum values of the Y axis.
- **Scale Button** — changes the scale values.

There are two scale buttons, displayed above the waveform graph to the right side, which can be used to change the scale values of the X axis and Y axis of the graph. There are four scales available for the X axis: x1, x2, x4 and x8. There are three scales available for the Y axis: x1, x2, and x4.

- **Edit Button** — edit the waveform color and the line thickness.
- **Zoom-in Button** — tap once to display the selected data graph in full screen.
- **Exit Button** — tap to exit the waveform graph mode.

**Full Screen Display** — this option is only available in the waveform graph mode, and primarily used in Graph Merge status for data comparison. There are four control buttons available on the top right side of the screen under this mode.

- **Scale Button** — tap to change the scale values below the waveform graph. There are four scales available for the X axis: x1, x2, x4 and x8, and three scales available for the Y axis: x1, x2, and x4.
- **Edit Button** — tap to open an edit window, in which you can set the waveform color and the line thickness displayed for the selected parameter item.
- **Zoom-out Button** — tap to exit full screen mode.
- **Exit Button** — tap to exit the waveform graph mode.

➤ **To edit the waveform color and line thickness in a data graph**

1. Select parameters to display in Waveform Graph mode.
2. Tap the **Edit** Button, and an edit window will appear.
3. The parameter is selected automatically in the left column.
4. Select a color from the second column.
5. Select a line thickness from the right column.
6. Tap **Done** to save the settings and exit, or tap **Cancel** to exit without saving.

🔗 **NOTE**

In full screen mode, you can edit the waveform color and line thickness by tapping the **Edit** button on the top-right side of the screen.

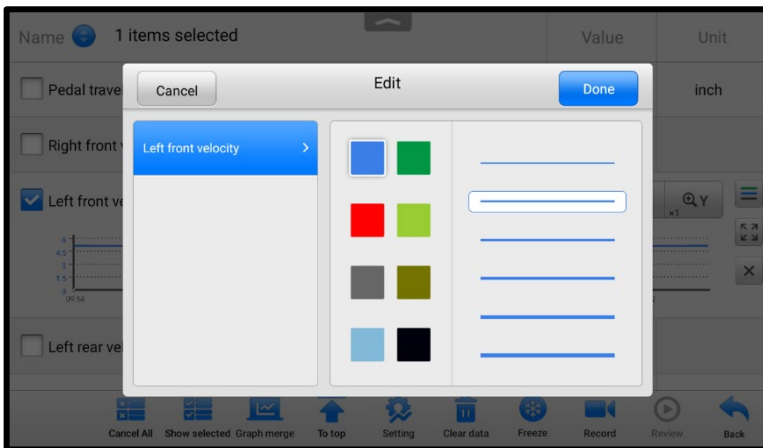

**Figure 4-12 Waveform Edit Screen**

- ◆ **Digital Gauge Mode** — displays the parameters in the form of a digital gauge graph.

**B. Trigger Settings**

On the Trigger Settings screen, you can set a standard range by filling in a minimum value and a maximum value. When exceeding this range, the trigger function will be executed and the tablet will automatically record and save the generated data. You can review the saved live data by tapping the **Review** button at the bottom of the screen.

Tap the drop-down button on the right side of a parameter to open a submenu. The **Trigger** button is the last one in the submenu. Tap to display the Trigger Settings screen.

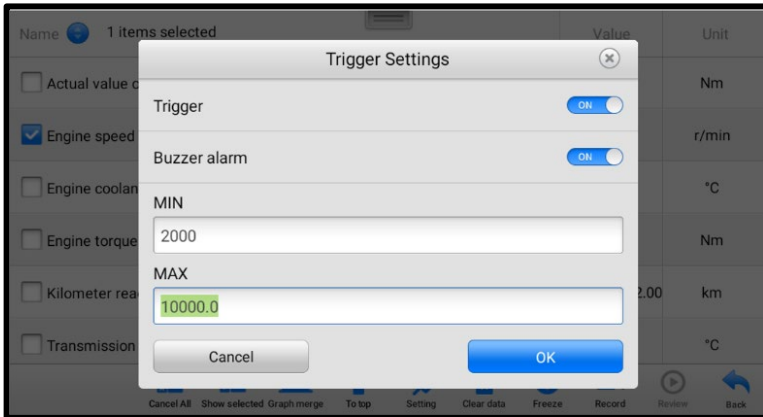

**Figure 4-13 Trigger Setting Screen**

Two buttons and two input boxes are available in the Trigger Settings screen.

- a) **Trigger On** — switches the trigger on and off. The trigger is ON by default.
- b) **Buzzer Alarm** — switches the alarm on and off. The alarm function makes a beeping sound to alert you when the data reading reaches the preset minimum or maximum values. The buzzer alarm will only sound at the first trigger.
- c) **MIN** — tap this input box to enter the required lower threshold value.
- d) **MAX** — tap this input box to enter the required upper threshold value.

➤ **To set a trigger**

1. Tap the drop-down button on the right of a parameter to open a submenu.
2. Tap the **Trigger** button on the right side of the submenu to open the Trigger Settings screen.
3. Tap the **MIN** input box and enter the required minimum value.
4. Tap the **MAX** input box and enter the required maximum value.
5. Tap **OK** to save the settings and return to the Live Data screen, or tap **Cancel** to exit without saving.

When the trigger is set, a trigger mark will appear in front of the parameter. The mark is gray when it is not triggered, and displays orange when triggered. Moreover, two horizontal lines display on each of the data graphs (when Waveform Graph Mode is applied) to indicate the alarm point. The threshold lines are shown in different colors to differentiate them from the parameter waveforms.

**C. Function Buttons**

The operations of available function buttons on the Live Data screen are described

below:

**Cancel All** — tap to cancel all selected parameters. Up to 50 parameters can be selected at one time.

**Show Selected/Show All** — tap to switch between the two options. One displays the selected parameters, the other displays all available items.

**Graph Merge** — tap to merge selected data graphs (for Waveform Graph Mode only). This function is very useful when comparing different parameters.

---

## NOTE

This mode supports the merging of 2 to 5 parameters from different graphs. Only quantitative parameters are supported.

---

### ➤ **To merge selected data graphs**

1. Select parameters to be merged.
2. Tap the **Graph Merge** button at the bottom of the Live Data screen.
  - This mode only supports quantitative parameters that can be represented digitally. If non-digital parameters are selected, a message will display advising the user that the selected parameters are not supported in this mode and to select 2 to 5 digital parameters. Tap **Got It** to return to the previous screen and select supported parameters.
  - When unsupported parameters are selected, a message will appear advising the user to select only supported parameters. A message will also appear if more than 5 parameters have been selected. Please select 2 to 5 supported parameters and tap the **OK** button to merge.
3. Tap the **Cancel Merging** button at the bottom of the Live Data screen to cancel merging.

**To Top** — moves a selected data to the top of the list.

**Setting** — tap to set recording duration: From 5 seconds to 60 minutes.

### ➤ **To set live data recording duration**

1. Tap the **Setting** button at the bottom of the Live Data screen.
2. Tap the “>” button to the right of **Recording Time After Trigger** bar and select a time length.
3. Tap **OK** to save the setting and return to the Live Data Setting screen, or tap the “x” button at the upper-right corner to exit without saving.
4. Tap **Done** at the upper-right corner of the Live Data Setting screen to confirm and save the setting, and return to the Live Data screen, or tap **Cancel** to exit without saving.

**Clear Data** — tap to clear all cached live data.

**Freeze** — displays a still capture of retrieved data.

- Previous Frame — moves to the previous frame of frozen data.
- Next Frame — moves to the next frame of frozen data.
- Play/Pause — tap to play/pause the frozen data.
- Resume — tap to exit the freeze data mode and return to live data display.

**Record** — starts recording the live data of the selected data items. Tap the **Record** button at the bottom of the Live Data screen. A message will display prompting user to select parameters to record. Tap **Got It** to confirm. Scroll down and select data to record. Tap the **Record** button to start recording. Tap the **Resume** button to stop recording. The recorded live data can be viewed in the **Review** section at the bottom of the Live Data screen. The recorded data can also be reviewed in the Data Manager application.

- Resume — tap to stop data recording and return to normal data display.
- Flag — displays when the Record function is applied. Tap to set flags to mark points of interest when recording data. Notes can be added during playback in Review or Data Manager. Select the preset flag to open a popup window and display a virtual keyboard to enter notes.

**Review** — reviews the recorded data. Tap the **Review** button to display a list of recordings. Select an item to review.

---

 **NOTE**

Only data recorded during the current operation can be reviewed on the Live Data screen. All historical recorded data can be reviewed in Review Data in the Data Manager application.

---

- Previous Frame — moves to the previous frame of recorded data.
- Next Frame — moves to the next frame of recorded data.
- Play/Pause — tap to play/pause the recorded data.
- Show Selected — displays the selected parameters.
- Graph Merge — merges selected data graphs.
- Back — exits the review and returns to the Live Data screen.

**Back** — returns to the previous screen or exits the function.

#### 4.4.4 Active Test

The Active Test function is used to access vehicle-specific subsystem and component tests. Available tests vary by vehicle.

During an active test, the tablet sends commands to the ECU to activate the actuators. This test determines the integrity of the system or part by reading ECU data, or by

monitoring the operation of the actuators. Such tests may include switching a solenoid, relay or switch, between two operating states.

Selecting Active Test displays a menu of test options. Available tests vary by vehicle. Select a test from the menu options. Follow the instructions displayed on the screen to complete the test. Procedures and instructions vary by vehicle.

The function buttons in the lower-right corner of the Active Test screen manipulate the test signals. Operational instructions are displayed in the main section of the test screen. Follow the on-screen instructions and make appropriate selections to complete the tests. Tap the **ESC** button to exit the test when finished.

## 4.4.5 Special Functions

These functions perform various component adaptations, including the recalibration or configuration of certain components after repairs or replacements have been completed.

Select a function to display detailed information and the execution screen.

Tap a function button to perform the selected function or exit the function.

## 4.5 Generic OBDII Operations

---

OBDII/EOBD vehicle diagnosis option offers a quick way to check for DTCs, isolate the cause of an illuminated malfunction indicator lamp (MIL), check monitor status prior to emissions certification testing, and perform other emissions-related services. The OBDII direct access option is also used for testing OBDII/EOBD-compliant vehicles that are not included in the database. Diagnostics toolbar buttons at the top of the screen are available for specific vehicle diagnostics. See [Table 4-2 Diagnostics Toolbar Buttons](#) for details.

### 4.5.1 General Procedure

#### ➤ To access the OBDII/EOBD diagnostics functions

1. Tap the **Diagnostics** application button from the MaxiCOM Job Menu. The Vehicle Menu will appear.
2. Tap the **EOBD** button. There are two options for establishing communication with the vehicle.
  - **Auto Scan** — select to establish communication using each protocol in order to determine which one the vehicle is using.
  - **Protocol** — select to open a submenu of available protocols. A communications protocol is a standardized way of data communication

between an ECM and a diagnostic tool. Global OBD may use several different communications protocols.

3. Select a specific protocol under the **Protocol** option. Wait for the OBDII Diagnostics Menu to appear.
4. Select a function to continue. Supported functions may vary by vehicle.
  - DTC & FFD
  - I/M Readiness
  - Live Data
  - On-Board Monitor
  - Component Test
  - Vehicle Information
  - Vehicle Status

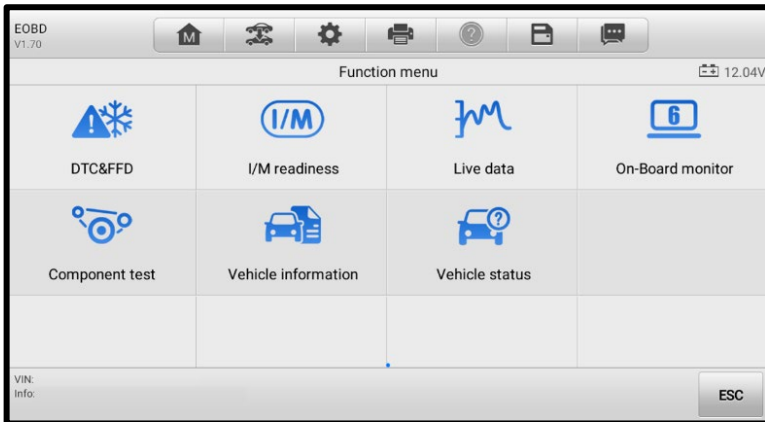

**Figure 4-14 OBDII Diagnostics Menu Screen**

## 4.5.2 Function Descriptions

This section describes the various functions of each diagnostic option:

### 4.5.2.1 DTC & FFD

When this function is selected, the screen displays a list of stored codes and pending codes. When the Freeze frame data of certain DTCs are available for viewing, a snowflake button will display on the right side of the DTC item. The Erase Codes and Read codes functions can be applied by tapping the function buttons at the bottom of the screen.

- **Stored Codes**

Stored codes are emissions-related DTCs from the ECU of the vehicle. OBDII/EOBD codes are prioritized according to their emissions severity, with higher-priority codes overwriting lower-priority ones. The priority of the code determines the illumination of the Malfunction Indicator Lamp (MIL) and the codes erase procedure. Manufacturers rank codes differently, so DTCs may vary by vehicle.

- **Pending Codes**

These are codes whose storing conditions have been met during the last drive cycle, but need to be met on two or more consecutive drive cycles before the DTC is stored. The purpose of displaying pending codes is to assist the service technician after a vehicle repair when diagnostic information is cleared, by reporting test results after a single drive cycle.

- a) If a test fails during the drive cycle, the DTC associated will be reported. If the pending fault does not occur again within 40 to 80 warm-up cycles, the fault is automatically cleared from memory.
- b) Test results reported do not necessarily indicate a faulty component or system. If test results indicate another failure after additional driving, a DTC is stored to indicate a faulty component or system.

- **Freeze Frame**

In most cases, the stored frame is the last DTC reported. Certain DTCs, those that have a greater impact on vehicle emission, have a higher priority. In these cases, DTCs of the highest priority will be retained. Freeze frame data includes a "snapshot" of critical parameter values at the time the DTC is stored.

- **Erase Codes**

This option is used to clear all emissions-related diagnostics data including DTCs, freeze frame data, and specific manufacturer-enhanced data from the vehicle ECU. This option resets the I/M Readiness Monitor Status for all vehicle monitors to "Not Ready" or "Not Complete".

A confirmation screen will appear when the Clear Codes option is selected to prevent accidental loss of data. Select **Yes** on the confirmation screen to continue or **No** to exit.

#### 4.5.2.2 I/M Readiness

This function is used to check the readiness of the monitoring system. It is an excellent function to use prior to having a vehicle inspected for local emissions compliance. Selecting I/M Readiness opens a submenu with two choices:

- **Since DTCs Cleared** — displays the status of monitors since the last time the DTCs were erased.

- This Drive Cycle — displays the status of monitors since the beginning of the current drive cycle.

#### 4.5.2.3 *Live Data*

This function displays the real time PID data from the ECU. Displayed data includes analog and digital input and output, and system status information broadcast in the vehicle data stream.

Live data can be displayed in various modes. See [Live Data](#) for detailed information.

#### 4.5.2.4 *On-Board Monitor*

This option allows you to view the results of On-Board Monitor tests. The tests are useful after the service when a vehicle's control module memory is already erased.

#### 4.5.2.5 *Component Test*

This function enables dual-directional control of the ECM so that the tablet can transmit control commands to operate the vehicle systems. This function is useful in determining how well the ECU responds to a command.

#### 4.5.2.6 *Vehicle Information*

This function enables the display of the vehicle identification number (VIN), calibration identification number, calibration verification number (CVN), and other information of the test vehicle.

#### 4.5.2.7 *Vehicle Status*

This function checks the current condition of the vehicle, such as the communications protocols of OBDII modules, quantity of fault codes, and the status of the Malfunction Indicator Light (MIL).

## 4.6 Diagnostic Reports

---

### 4.6.1 Pre-Scan and Post-Scan Functions

After performing pre-scan and post-scan functions by entering the same maintenance order number, tap **Data Manager > Vehicle History** to select the historical test record named with the maintenance order number. Both the pre-scan and post-scan results will be displayed in the same historical test record, which can be generated as a PDF report for easy data comparison.

- **Pre-Scan Function**

Select a vehicle button from the Vehicle Menu screen. Enter the maintenance order number in the pop-up box to scan and detect the whole vehicle. You can also add pictures to record the current condition of the vehicle. Once the pre-scan is completed, you are not allowed to perform pre-scan again, and the scan result cannot be modified.

- **Post-Scan Function**

After the pre-scan is complete, exit this diagnostic session. Then select the vehicle brand from the Vehicle Menu screen again. Enter the same maintenance order number in the pop-up box. The post-scan will proceed and the record will be generated after scanning.

---

 **NOTE**

The post-scan function can be performed repeatedly. After exiting the vehicle, you only need to tap the vehicle button from the Vehicle Menu screen to reconnect again, then enter the same maintenance order number in the pop-up box and follow the steps to rescan. The last post-scan result is the final one.

---

## 4.6.2 Diagnostics Report Saving, Viewing, and Sharing

The diagnostic report can be reviewed, saved, and shared with others through many ways.

### 4.6.2.1 *Diagnostics Report Saving*

- Via the **History** function

1. Enter the main screen of the Diagnostics application, and tap **History** on the top toolbar.

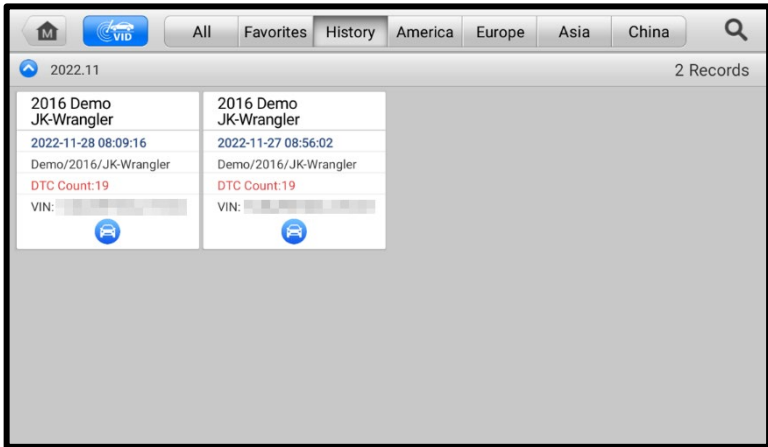

**Figure 4-15 History Screen**

2. Select a record and tap the **...** button on the upper-right corner.

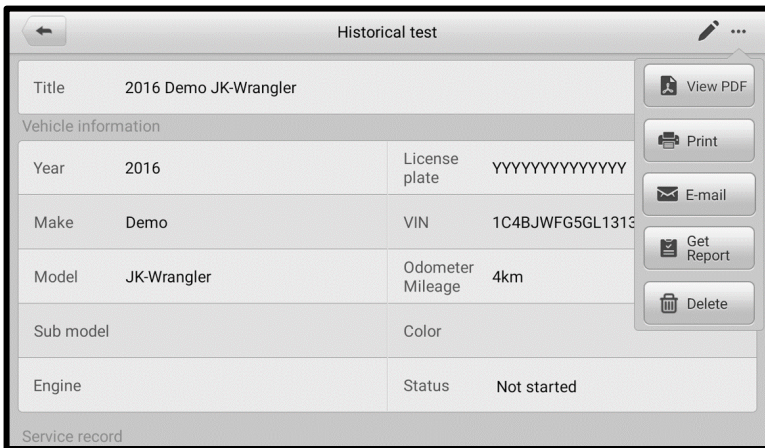



**Figure 4-16 Historical Test Screen**

3. Tap **Get Report**. Enter the license plate and current mileage. Tap **Save**.



- Via the functions on the Diagnostics Toolbar

The diagnostic report can also be viewed from such diagnostic function screens as Auto scan and Trouble codes. There are two ways to view the saved reports:

- ✧ Tap the  button in the diagnostics toolbar and select **Save All Data**. Enter the license number and tap **Save**. Tap the  button on the upper-right of the screen to view the report.
- ✧ Tap the  button in the diagnostics toolbar and select **Save Report**. Enter the license number and current mileage. Tap **Save > View Report** and then select a report to view.

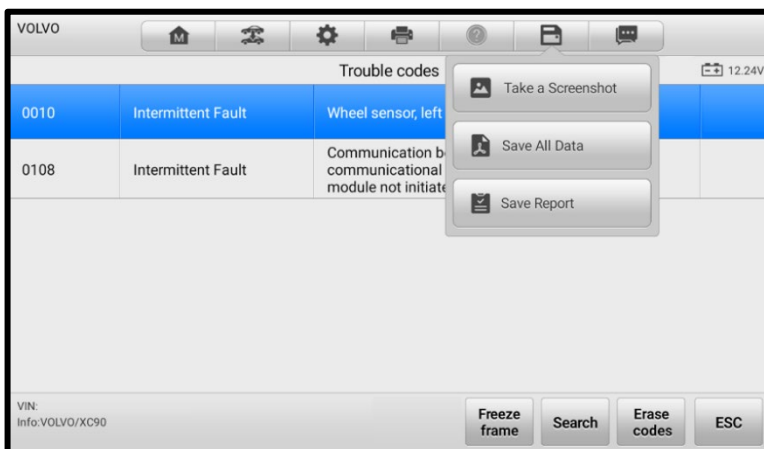

**Figure 4-19 Trouble Codes Screen**

#### 4.6.2.2 Diagnostics Report Viewing

All the saved reports can be viewed in the Data Manger application.

- ✧ Tap **Data Manager > Vehicle History**. Select a vehicle history record and then tap **View PDF** in the upper-right corner to view the report.
- ✧ Once you saved the reports by tapping the **Save All Data** button, tap **Data Manager > PDF** to view these reports.
- ✧ Once you saved the reports by tapping the **Get Report** or **Save Report** button, tap **Data Manager > Cloud Report** to view these reports saved to the Autel cloud platform.

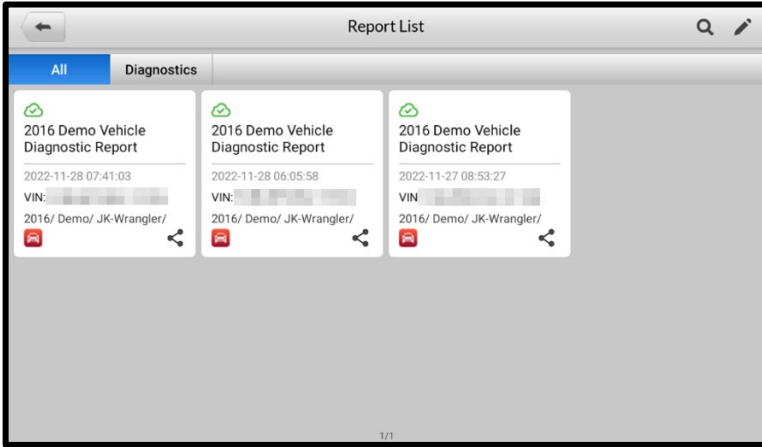

### 4.6.2.3 Diagnostics Report Cloud Sharing

1. Tap **Data Manager > Cloud Report** to enter the Report List screen.



**Figure 4-20 Report List Screen**

#### **NOTE**

Note that if the report displays , it means the report has been uploaded to the cloud successfully, and you can share the report with others; if the report displays , it means the report has failed to upload to the cloud, but will try to automatically upload to the cloud when entering the Report again.

2. Tap the  on the lower-right corner of the report.
3. There are three ways for report cloud sharing: scan the QR code, send by email, send by SMS (via phone number).

## 4.7 Exiting Diagnostics

The Diagnostics application remains open as long as there is an active communication with the vehicle. You must exit the diagnostics operation to stop all communications with the vehicle before closing the Diagnostics application.

#### **NOTE**

Damage to the vehicle electronic control module (ECM) may occur if communication is disrupted. Ensure all forms of communication link such as data cable, USB cable, and wireless or wired network, are properly connected throughout the test. Exit all interfaces before disconnecting the test cable and power supply.

➤ **To exit the Diagnostics application**

1. On an active diagnostic screen, tap the **Back** or **ESC** function button to exit a diagnostic session; Or
2. Tap the **Vehicle Swap** button in the diagnostics toolbar to return to the Vehicle Menu screen.
3. On the Vehicle Menu screen, tap the **Home** button on the top toolbar; or tap the **Back** button on the navigation bar at the bottom of the screen. Or
4. Tap the **Home** button on the diagnostics toolbar to exit the application directly and return to the MaxiCOM Job Menu.

Now, the Diagnostics application is no longer communicating with the vehicle and it is safe to open other MaxiCOM applications or exit the MaxiCOM Diagnostics System and return to the Android Home screen.

# 5 Service

The Service application is specially designed to provide quick access to the vehicle systems for various scheduled service and maintenance tasks. The typical service operation screen is a series of menu-driven commands. Follow the on-screen instructions to select appropriate options, enter values or data, and perform necessary actions. The application will display detailed instructions to complete selected service operations.

After entering a special function, the screen will display two options: **Diagnosis** and **Hot Functions**. **Diagnosis** enables the reading and clearing of codes, which is sometimes necessary after completing certain special functions. **Hot Functions** consists of sub functions of the selected special function.

The most commonly used services are described in this chapter.

## 5.1 Oil Reset Service

---

Perform reset for the Engine Oil Life system, which calculates an optimal oil life change interval depending on the vehicle driving conditions and climate. The Oil Life Reminder must be reset each time the oil is changed so that the system can calculate when the next oil change is required.

### IMPORTANT

- Always reset the engine oil life to 100% after every oil change.
  - All required work must be carried out before the service indicators are reset. Failure to do so may result in incorrect service values and cause DTCs to be stored by the relevant control module.
  - For some vehicles, the tool can reset additional service lights such as maintenance cycle and service interval. On BMW vehicles for example, service resets include engine oil, spark plugs, front/rear brakes, coolant, particle filter, brake fluid, micro filter, vehicle inspection, exhaust emissions inspection and vehicle checks.
- 

## 5.2 Electronic Parking Brake (EPB) Service

---

This function has a multitude of usages to maintain the electronic braking system including deactivating and activating the brake control system, assisting with brake fluid

control, opening and closing brake pads, and calibrating brakes after disc or pad replacement.

## 5.2.1 EPB Safety

It can be dangerous to perform Electronic Parking Brake (EPB) system maintenance, so before you begin the service work, please keep the following rules in mind:

- Ensure that you are fully familiar with the braking system and its operation before commencing any work.
- The EPB control system may require deactivation before carrying out any maintenance/diagnostic work on the brake system. This can be done from the tool menu.
- Only carry out maintenance work when the vehicle is stationary and on level ground.
- Ensure that the EPB control system is reactivated after the maintenance work has been completed.

---

### NOTE

Autel accepts no responsibility for any accident or injury arising from the maintenance of the EPB system.

---

## 5.3 Battery Management System (BMS) Service

---

The BMS (Battery Management System) allows the tool to evaluate the battery charge state, monitor the closed-circuit current, register the battery replacement, and activate the rest state of the vehicle.

---

### NOTE

- This function is not supported by all vehicles.
- The sub functions and actual test screens of the BMS may vary by vehicle. Follow the on-screen instructions to make correct selections.

---

The vehicle may use either a sealed lead-acid battery or an AGM (Absorbed Glass Mat) battery. Lead acid batteries contain liquid sulphuric acid and can spill when overturned. AGM batteries (valve regulated lead acid, VRLA batteries) also contain sulphuric acid, but the acid is contained in glass mats between terminal plates.

It is recommended that the replacement aftermarket battery has the same specifications, such as capacity and type, as the original battery. If the original battery is replaced with a different type of battery (e.g., a lead-acid battery is replaced with an AGM battery) or a battery with a different capacity (mAh), the vehicle may require reprogramming the new battery type in addition to performing the battery reset. Consult the vehicle manual for additional vehicle-specific information.

## 5.4 Steering Angle Sensor (SAS) Service

---

Steering Angle Sensor Calibration permanently stores the current steering wheel position as the straight-ahead position in the steering angle sensor EEPROM. Therefore, the front wheels and the steering wheel must be set exactly to the straight-ahead position before calibration. In addition, the vehicle identification number is also read from the instrument cluster and stored permanently in the steering angle sensor EEPROM. On successful completion of calibration, the steering angle sensor fault memory is automatically cleared.

Calibration must always be carried out after the following operations:

- Steering wheel replacement
- Steering angle sensor replacement
- Any maintenance that involves opening the connector hub from the steering angle sensor to the column
- Any maintenance or repair work on the steering linkage, steering gear or other related mechanism
- Wheel alignment or wheel track adjustment
- Accident repairs where damage to the steering angle sensor or assembly, or any part of the steering system may have occurred

---

### NOTE

- AUTEL accepts no responsibility for any accident or injury arising from servicing the SAS system. When interpreting DTCs retrieved from the vehicle, always follow the manufacturer's recommendation for repair.
  - All software screens shown in this manual are examples, actual test screens may vary for each vehicle being tested. Observe the menu titles and on-screen instructions to make correct option selections.
  - Before starting the procedure, make sure the vehicle has ESC. Look for the button on dash.
- 

## 5.5 Diesel Particle Filter (DPF) Service

---

The Diesel Particle Filter (DPF) function manages DPF regeneration, DPF component replacement teach-in, and DPF teach-in after replacing the engine control unit.

The ECM monitors driving style and selects a suitable time to employ regeneration. Cars driven a lot at idling speed and low load will attempt to regenerate earlier than cars driven with higher load and speed. In order for regeneration to take place, a prolonged high exhaust temperature must be obtained.

In the event of the car being driven in such a way that regeneration is not possible, i.e., frequent short journeys, a diagnostic trouble code will eventually be registered in addition

to the DPF light and "Check Engine" indicators. A service regeneration can be requested in the workshop using the diagnostic tool.

Before performing a forced DPF regeneration using the tool, check the following items:

- The fuel light is not on.
- No DPF-relevant faults stored in system.
- The vehicle has the specified engine oil.
- The oil for diesel is not contaminated.

---

**! IMPORTANT**

Before diagnosing a problematic vehicle and attempting to perform an emergency regeneration, it is important to obtain a full diagnostic log and read out relevant measured value blocks.

---

**🔧 NOTE**

- The DPF will not regenerate when the engine management light is on or when there is a faulty EGR valve.
  - The ECU must be re-adapted when replacing the DPF and when topping up the fuel additive Eolys.
  - If the vehicle needs to be driven in order to perform a DPF service, a second person is required for the function: One person should drive the vehicle while the other person observes the screen on the tool. Do not attempt to drive and observe the tablet at the same time. This is dangerous and puts your life and the lives of other motorists and pedestrians at risk.
- 

## 5.6 Tire Pressure Monitor System (TPMS) Service

---

This function allows you to quickly look up the tire sensor IDs from the vehicle's ECU and to perform TPMS replacement and reset procedures after tire sensors are replaced.

# 6 Data Manager



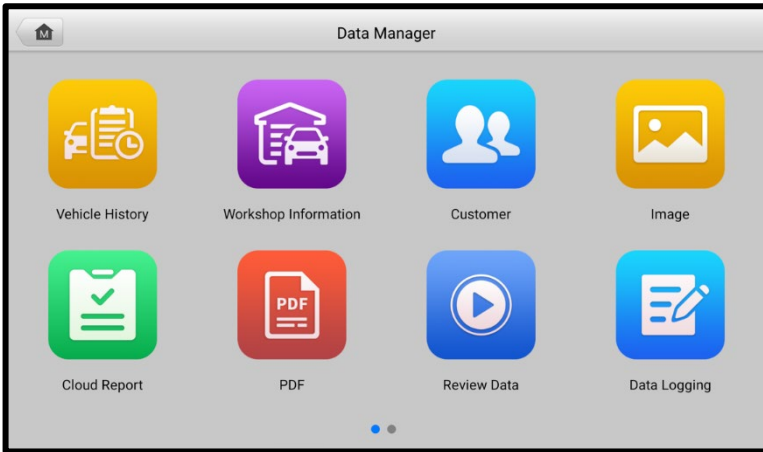

The Data Manager application allows you to store, print, and review the saved files, manage the workshop information, customer information records and keep test vehicle history records.





Selecting the Data Manager application opens the file system menu. There are nine main functions available.



**Figure 6-1 Data Manager Main Screen**

**Table 6-1 Buttons in Data Manager**

Button	Name	Description
	<b>Vehicle History</b>	Tap to review the diagnostic history record.
	<b>Workshop Information</b>	Tap to edit the information of workshops.
	<b>Customer</b>	Tap to create a new customer account file.
	<b>Image</b>	Tap to review the screenshots.

Button	Name	Description
	<b>Cloud Report</b>	Tap to review the saved reports and share cloud reports.
	<b>PDF</b>	Tap to review the reports stored as PDF format.
	<b>Review Data</b>	Tap to review the recorded data.
	<b>Data Logging</b>	Tap to review the communication data and ECU information of the test vehicle. The saved data can be reported and sent to the technical center via the Internet.
	<b>Uninstalled Apps</b>	Tap to uninstall applications.

## 6.1 Vehicle History

This function stores vehicle test records, including vehicle information and the retrieved DTCs from previous diagnostics sessions. Test information is summarized and displayed in an easy-to-read table listing. The Vehicle History also provides direct access to the previously tested vehicle and allows you to directly restart a diagnostic session without needing to perform auto or manual vehicle selection.

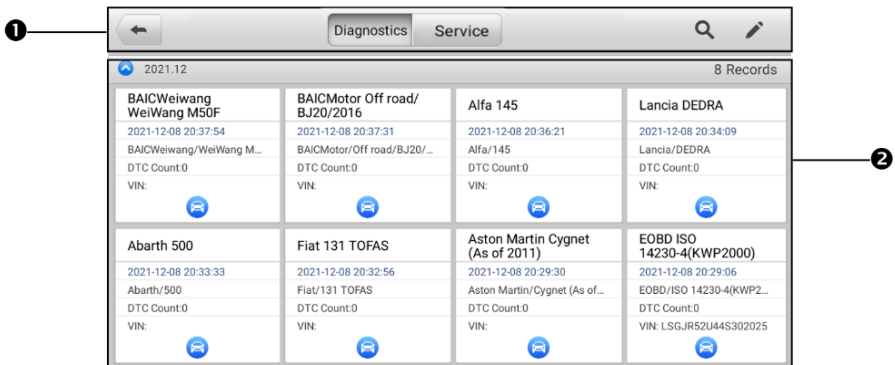

**Figure 6-2 Vehicle History Screen**

1. Top Toolbar Buttons — navigation and application controls.
2. Main Section — displays all vehicle test records.

- **To activate a test session for the recorded vehicle**
  1. Tap **Data Manager** on the MaxiCOM Job Menu.
  2. Select **Vehicle History** to open the screen. Tap **Diagnostics** or **Service** to select diagnostic test records or service test records.
  3. Tap the **Diagnostics** icon at the bottom of the thumbnail of a vehicle record. The Diagnostics screen of the vehicle will appear and a new diagnostic session will be activated. See [Diagnostics](#) for detailed instructions on vehicle diagnostic operations. Or,
  4. Select a vehicle thumbnail and choose a record. A Test History record sheet will appear. Review the recorded information for the test vehicle, and tap the **Diagnostics** button on the upper-right corner to continue diagnostics.

**NOTE**

The tablet must establish a communication link with the vehicle to restart test sessions on previously tested vehicles.

### 6.1.1 Historical Test Record

The Test History is a detailed data form for the tested vehicle, which includes general vehicle information, service records, customer information, and the diagnostic trouble codes retrieved from previous test sessions. Technician Notes will also be displayed, if present.

Vehicle information	
Title	2016 Demo JK-Wrangler
Year	2016
Make	Demo
Model	JK-Wrangler
Sub model	
Engine	
License plate	
VIN	1C4BJWFG5GL131334
Odometer Mileage	
Status	Not started

**Figure 6-3 Test History Sheet**

➤ **To edit the Test History**

1. Tap **Data Manager** on the MaxiCOM Job Menu.
2. Select **Vehicle History**.
3. Select the specific vehicle record thumbnail from the main section. The vehicle test record sheet will appear.
4. Tap **Edit** (a pen icon) to edit the record.
5. Tap each item to enter information or attach data files or images.

🔗 **NOTE**

The vehicle VIN number, license number, and the customer account information are correlated by default. Vehicle records will automatically be correlated using this vehicle and customer identification.

6. Tap **Add to Customer** to correlate the Test History with an existing customer account, or add a new associated account to be correlated with the test vehicle record. See [Customer](#) for more information.
7. Tap **Done** to save the updated record, or tap **Cancel** to exit without saving.

## 6.2 Workshop Information

The Workshop Information form allows you to enter, edit, and save detailed workshop information, such as shop name, business address, phone number, and other remarks, which, when printing vehicle diagnostic reports and other associated test file, will display as the header of the printed documents.

Workshop information	
Basic information	
Set shop logo	Logo
<input type="text"/>	<input type="text"/>
Shop name	Tel
<input type="text"/>	<input type="text"/>
State	Fax
<input type="text"/>	<input type="text"/>
City	E-mail
<input type="text"/>	<input type="text"/>
Zip code	<input type="text"/>
Address	<input type="text"/>
More information	
Manager name	Manager title
<input type="text"/>	<input type="text"/>
Website	<input type="text"/>

**Figure 6-4 Workshop Information Sheet**

➤ **To edit your Workshop Information**

1. Tap the **Data Manager** application on the MaxiCOM Job Menu.
2. Select **Workshop Information**.
3. Tap on each field to enter information.
4. Tap **Done** to save the updated workshop information record, or tap **Cancel** to exit without saving.

## 6.3 Customer

---

The Customer function allows you to create and edit customer accounts. It helps you to save and organize your customer information accounts, which can then be correlated with the associated test vehicle records.

➤ **To create a customer account**

1. Tap the **Data Manager** application on the MaxiCOM Job Menu.
2. Select **Customer**.
3. Tap the **Add a Customer** button. A blank information form will appear. Tap each field to enter the appropriate information.

---

 **NOTE**

The items that must be filled are indicated as required fields.

---

4. Some customers may have more than one vehicle for service; you can always add new vehicle information to a customer account. Tap **Add New Vehicle Information**, and then fill in the vehicle information.
5. Tap **Complete** to save the account, or tap **Cancel** to exit without saving.

➤ **To edit a customer account**

1. Tap **Data Manager** on the MaxiCOM Job Menu.
2. Select **Customer**.
3. Select a customer account by tapping the corresponding name card. A Customer Information record will appear.
4. Tap **Edit** on the top toolbar to edit the record.
5. Tap on the input field to edit the information, and enter updated information.
6. Tap **Complete** to save the updated information, or tap **Cancel** to exit without saving.

➤ **To delete a customer account**

1. Tap **Data Manager** on the MaxiCOM Job Menu.
2. Select **Customer**.
3. Tap the **Delete** icon on the right of a customer account. A message displays.
4. Tap **OK** to confirm the command, and the account is deleted, or tap **Cancel** to cancel the request.

## 6.4 Image

---

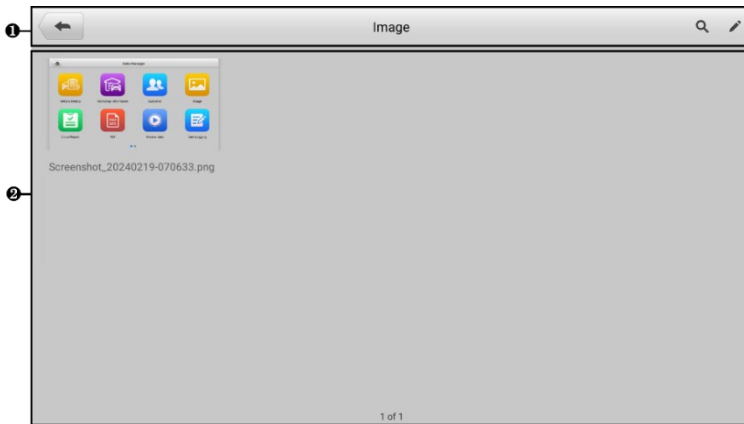

The Image section is a database containing all captured screenshots.

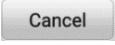





**Figure 6-5 Image Screen**

1. **Toolbar Buttons** — used to edit, print or delete image files. See the following table for detailed information.
2. **Main Section** — displays stored images.

**Table 6-2 Toolbar Buttons in Image**

Button	Name	Description
	<b>Back</b>	Returns to the previous screen.
	<b>Search</b>	Tap to search the database.

Button	Name	Description
	<b>Edit</b>	Tap to display the editing toolbar to delete, print or email images.
	<b>Cancel</b>	Tap to close the editing toolbar or cancel file search.
	<b>Print</b>	Tap to print the selected image.
	<b>Delete</b>	Tap to delete the selected image.
	<b>Email</b>	Tap to send the selected image to an email address.

➤ **To edit/delete images**

1. Select **Data Manager** from the MaxiCOM Job Menu.
2. Select **Image** to access the image database.
3. Tap **Edit** on the top-right corner of the screen. The editing screen will appear.
4. Select the image(s) you want to edit.
5. Tap **Delete** to delete the selected images or delete all images. Tap **Print** to select to print the selected image(s), or tap **Email** to send the selected images to an email address.

## 6.5 Cloud Report

---

This section displays the saved reports, which can be transferred to the Autel cloud platform once a stable network connection is established. These reports can then be viewed or shared with others. See [Report Settings](#) and [Diagnostics Report Saving, Viewing, and Sharing](#) for further details.

## 6.6 PDF Files

---

The PDF files designated for local viewing are displayed in this section. Enter the PDF database and select a file to access the saved information.

This section uses the standard Adobe Reader application for file viewing and editing. Refer to the Adobe Reader manual for more detailed instructions.

## 6.7 Review Data

---

The Review Data section allows you to play back recorded data frames of live data streams.

On the Review Data main screen, select a record file to play back.

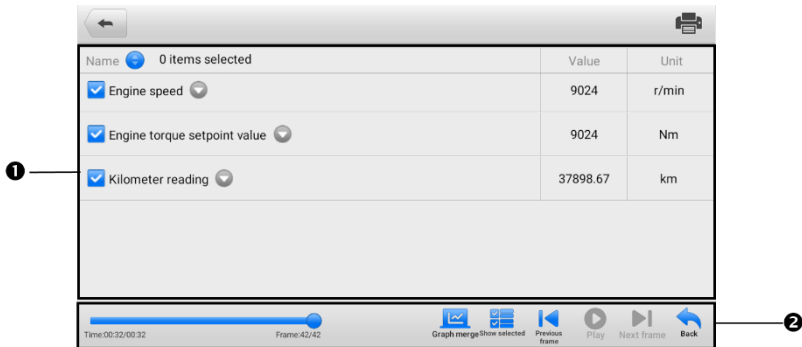

**Figure 6-6 Data Playback Screen**

1. Main Section — displays the recorded data frames.
2. Navigation Toolbar — allows you to manipulate data playback.

Use the Navigation Toolbar buttons to play back the recorded data from frame to frame. Tap **Back** to exit data playback.

## 6.8 Data Logging

---

The Data Logging section allows you to launch the Support platform to view records of all feedback or no feedback data logs on the diagnostics system. For more details, refer to [Data Logging](#).

## 6.9 Uninstall Apps

---

This section allows you to manage the software applications installed on the MaxiCOM diagnostics system. Selecting this section opens a management screen, on which you can check all available vehicle diagnostic applications.

Select the vehicle software you want to delete by tapping on the vehicle brand icon, after which the selected item will display a blue mark at the upper-right corner. Tap the **Delete** button on the top bar to delete the software from the system database.

# 7 Settings

Selecting Settings application opens a setup screen, on which you can adjust default settings and view information about the MaxiCOM system. The following options are available for the MaxiCOM system settings:

- Unit
- Language
- Printing Settings
- Report Settings
- Push Notifications
- Firmware Upgrade
- Auto Update
- Vehicle List
- System Settings
- About

This section describes the operation procedures for the settings.

## 7.1 Unit

---

This option allows you to adjust the measurement unit for the diagnostics system.

### ➤ To adjust the unit setting

1. Tap **Settings** on the MaxiCOM Job Menu.
2. Tap **Unit** on the left column.
3. Select the appropriate measurement unit. A check mark will display to the right of the selected unit.
4. Tap the **Home** button on the top-left corner to return to the MaxiCOM Job Menu, or select another setting option for system setup.

## 7.2 Language

---

This option allows you to adjust the display language for the MaxiCOM system.

➤ **To adjust the language setting**

1. Tap **Settings** on the MaxiCOM Job Menu.
2. Tap **Language** on the left column.
3. Select the appropriate language. A check mark will display to the right of the selected language.
4. Tap the **Home** button on the top-left corner to return to the MaxiCOM Job Menu, or select another setting option for system setup.

## 7.3 Printing Settings

---

Configure this option to enable the tablet to print via network.

➤ **To setup the printer connection**

1. Tap the **Settings** application on the MaxiCOM Job Menu.
2. Tap the **Printing Settings** option on the left column.
3. Tap **Print via PC-link** or **Print via Wi-Fi** to activate the printing function, which enables the device to send files to the printer through the PC via Wi-Fi or Ethernet connection.
4. Tap the **Home** button on the top-left corner to return to the MaxiCOM Job Menu, or tap another setting to adjust.

### 7.3.1 Printing Operations

If the Wi-Fi printer is not available, you can use your PC to print the data on the tablet. Follow the instructions below to operate.

➤ **To install the PC Link driver program**

1. Download the **Maxi PC Suite** software from [www.autel.com](http://www.autel.com) > **Support** > **Downloads** > **Autel Update Tools**, and install it to your windows-based PC.
2. Double click on **Setup.exe**.
3. Select the installation language and the wizard will load momentarily.
4. Follow the instructions on the screen and click **Next** to continue.
5. Click on **Install** and the printer driver program will be installed onto the PC.
6. Click on **Finish** to complete the installation.

---

 **NOTE**

The MaxiSys Printer runs automatically after the installation. The PC, printer, and the tablet must be connected to the same network.

---

This section describes how to receive files from the tablet and perform printing through the PC.

---

 **NOTE**

- Make sure the tablet is connected to the same network with your PC, either via Wi-Fi or LAN, before printing.
  - Make sure the PC installed with the Printing Services program is connected to a printer.
- 

 **To perform printing through the PC**

1. Run the **PC Link** program on the PC.
  2. Select the **MaxiSys Printer** tab.
  3. Tap the **Print** button on the top toolbar of the tablet. A test document will be sent to the PC.
    - ◇ If the **Auto Print** option in the MaxiSys Printer is selected, the MaxiSys Printer will print the received document automatically.
    - ◇ If the **Auto Print** option is not selected, click the **Open PDF File** to view all the temporary files. Select the file(s) needed for printing, then tap **Print**.
- 

 **NOTE**

To confirm that the printer is functioning normally, you can click **Test Print** in the PC Link program to test.

---

## 7.4 Report Settings

---

Two options are available in this section: Scan Report and Report Upload to Cloud.

- Scan Report

Toggle the **ON/OFF** button to enable/disable Pre-Scan and Post-Scan functions, which enable the user to compare the changes between pre-scan and post-scan. For more information about the pre-scan and post-scan functions, see [Pre-Scan and Post-Scan Functions](#) for details.

- Report Upload to Cloud

This option automatically synchronizes the diagnostics information of the vehicle to the vehicle history and forms a diagnostic report for the user to upload. Tap the **ON/OFF** button to enable/disable the Report Upload to Cloud function. The button

appears blue if the function is enabled and displays gray if the function is disabled.

---

 **NOTE**

Make sure the tablet is connected to network while uploading reports.

---

## 7.5 Push Notifications

---

This option allows you to manage notifications. The Notification Preferences option is turned on by default and cannot be turned off by users so that certain system notifications such as system security warnings will not be blocked.

➤ **To manage other notifications**

1. Tap the **Settings** application on the MaxiCOM Job Menu.
2. Tap the **Push Notifications** option on the left column.
3. Tap the ▼ button on the right of the Other Notifications option to open a drop-down list.
4. There are four options: Enable All Notifications, Limit to 3 Notifications or Less per Week, Limit to 1 Notification per Week, and Disable All Notifications. Select whichever you prefer.

 **NOTE**

- Notifications will display on the screen. Slide the screen from top to check the received messages. If the message list covers more than one screen, slide the list up or down to view them.
  - Tapping a specific message launches the corresponding application. For example, if you tap on an Update notification, the Update application will be launched.
- 

## 7.6 Firmware Upgrade

---

This option allows you to upgrade the firmware of the tool. Connect the tablet to the vehicle through DLC and use the USB type-C cable for power supply. Follow the on-screen instructions to complete the operation. Internet connection is necessary for this operation.

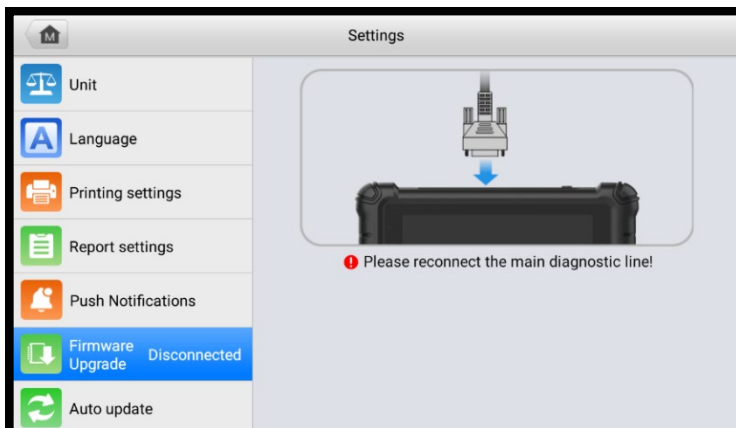

**Figure 7-1 Firmware Upgrade Screen**

➤ **To upgrade the firmware**

1. Connect the tablet to the vehicle using the main cable.
2. Tap **Settings** on the MaxiCOM Job Menu.
3. Tap **Firmware Upgrade** on the left column.
4. Tap the **Update Now** button to upgrade the latest firmware version.
5. Tap the **Home** button on the top-left corner to return to the MaxiCOM Job Menu, or select another setting option for system setup.

## 7.7 Auto Update

---

This option allows you to set the specific time for updating software automatically. There are three update options: **OS Update**, **MaxiCOM Update**, and **Vehicle Update**.

Tap the **ON/OFF** button to enable/disable the Auto Update function. The button will display blue if Auto Update is enabled and gray if disabled. Set the time of the day for updating. If a specific time is set, the selected software will be automatically updated at the exact time.

 **NOTE**

Internet connection is necessary for auto update, otherwise, it would not work even if you have already switched it on. Make sure the tool is connected to the Internet for the time you have set.

---

## 7.8 Vehicle List

---

This option allows you to sort the vehicles either by alphabetic order or by using frequency.

➤ **To adjust the vehicle list setting**

1. Tap **Settings** on the MaxiCOM Job Menu.
2. Tap **Vehicle List** on the left column.
3. Select the desired sort order. A check mark will appear to the right of the selected item.
4. Tap the **Home** icon on the top-left corner to return to the MaxiCOM Job Menu, or select another setting option for the system setup.

## 7.9 System Settings

---

This function provides you with direct access to the Android system settings interface, where you can adjust various system settings for the Android operating system, regarding wireless and network settings, various device settings such as sound and display, as well as system security settings, and check related information about the Android system. Refer to your Android documentation for additional information.

## 7.10 About

---

The About option provides information of the MaxiCOM diagnostics device including the product name, version, hardware, and serial number.

➤ **To check the MaxiCOM product information in About**

1. Tap **Settings** on the MaxiCOM Job Menu.
2. Tap **About** on the left column. The product information screen will appear on the right.
3. Tap the **Home** button on the top-left corner to return to the MaxiCOM Job Menu, or select another setting option for the system setup.

# 8 Update

The Update application allows you to download the latest released software. The updates can improve the MaxiCOM applications' capabilities, typically by adding new tests, new models, or enhanced applications to the database.

The tablet automatically searches for available updates for all of the MaxiCOM software when it is connected to the Internet. Any updates that are found can be downloaded and installed on the device. This section describes installing an update to the MaxiCOM system.



---

## NOTE

Ensure the tablet is registered before utilizing the Update application. See [Autel User Center](#) for a comprehensive registration guide.

---

### To update the software

1. Power up the tablet, and ensure that it is connected to a power source and has a steady Internet connection.
  2. Tap the **Update** application button from the MaxiCOM Job Menu. The Update application screen displays.
  3. On the Update screen, tap the **Get** button to update the specific item(s) or tap the **Update All** button to update all available items.
  4. Tap **More** to view the details of all the available updates. You can also tap the **Get** or **Update All** button for update.
  5. During the update, tap the  icon to suspend the updating process. Tap the  icon to resume the update and the process will continue from the pause point.
  6. When the updating process is completed, the software will be installed automatically. The new version will replace the older version.
- 

## NOTE

For the account management, proceed to the Member Center tab.

---

# 9 Remote Desktop

The Remote Desktop application launches the TeamViewer QuickSupport program, which is a simple, fast, and secure remote control interface. You can use the application to receive remote support from Autel's support center, colleagues or friends, by allowing them to control your MaxiCOM tablet on their PC via the TeamViewer software.

If you think of a TeamViewer connection as a phone call, the TeamViewer ID would be the phone number under which all TeamViewer Clients can be reached separately. Computers and mobile devices that run TeamViewer are identified by a unique global ID. The first time the Remote Desktop application is launched, this ID is generated automatically based on the hardware characteristics and will not change later on.

Make sure the tablet is connected to the Internet before launching the Remote Desktop application, so that the tablet is able to receive remote support from a third party.

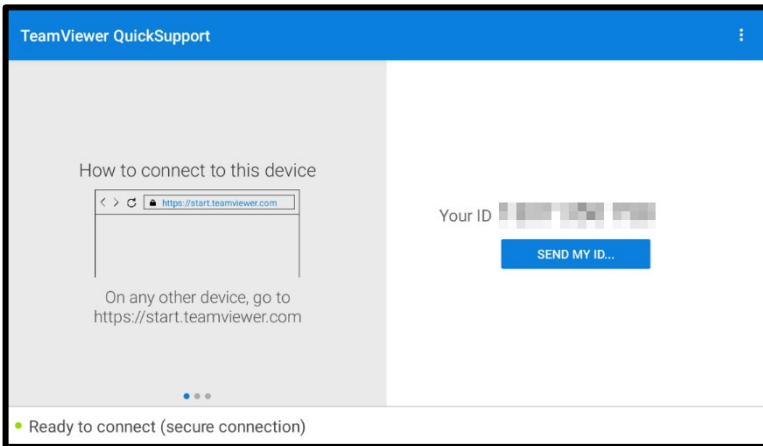

**Figure 9-1 Remote Desktop Screen**

➤ **To receive remote support from a partner**

1. Power on the tablet.
2. Tap the **Remote Desktop** application on the MaxiCOM Job Menu. The TeamViewer QuickSupport screen appears and the device ID is generated and shown.

3. Your partner must install the Remote Control software to their PC by downloading the TeamViewer program (full version) online (see <http://www.teamviewer.com>), and then launch the software.
4. Provide your ID to the partner and wait for them to send you a remote control request.
5. A prompt will appear asking you to allow remote control on your device.
6. Tap **Allow** to accept or **Deny** to reject.

Refer to the associated TeamViewer documents for additional information.

# 10 Support

This application launches the Support platform which synchronizes Autel's online service base station with the MaxiCOM tablet. Connected to Autel's service channel and online communities, the Support application provides the quickest way for problem solutions, allowing you to send help requests to obtain direct service and support.

## 10.1 Support Screen Layout

The main section of the Support screen is comprised of two sections. The left column is the main menu; select one subject from the main menu to display the corresponding function interface on the right.

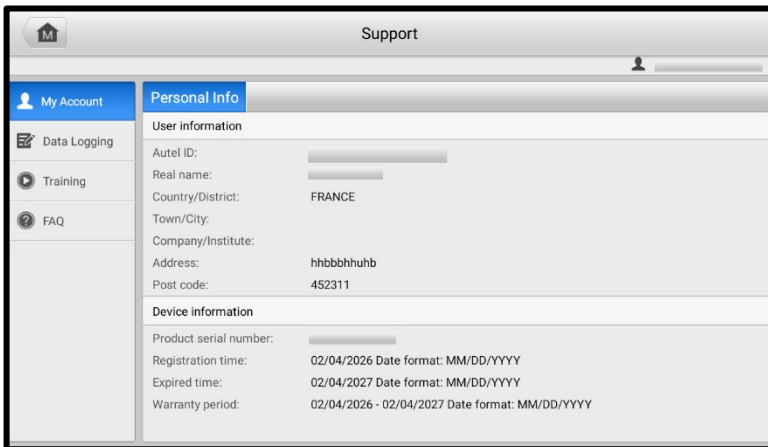

Figure 10-1 Support Screen

## 10.2 My Account

The My Account screen displays the comprehensive information of the user and the product, which is synchronized with the online registered account, including user and device information.

- **User Information** — displays detailed information of your registered online Autel account, such as your Autel ID, Name, Address, and other contact information.

- **Device Information** — displays the registered product information, including the serial number, registration date, expire date, and warranty period.

## 10.3 Data Logging

---

The Data Logging screen keeps records of all **Feedback** (submitted), **No Feedback** (not submitted but saved) or **History** (up to the latest 20 test records) data loggings on the diagnostic system. You can edit and send test records by using the Data Logging function. Autel support personnel will receive and process submitted reports through the Support platform.

### ➤ To make a reply in a Data Logging session

1. Tap **Feedback** to view a list of submitted data logs.
2. Select a specific item to view the latest update of the processing progress.
3. Tap on the input field at the bottom of the screen and enter your reply. Additionally, you can add the attachment if needed.
4. Tap **Send** to deliver your message to Autel support.

## 10.4 Training

---

The Training section provides quick links to Autel's online video library. Select a video channel by language to see all available online tutorial videos on topics such as product usage techniques and vehicle diagnostics practice.

## 10.5 FAQ

---

The FAQ section provides comprehensive references for all questions frequently asked and answered about the use of Autel's online member account, and shopping and payment procedures.

- **Account** — displays questions and answers about the use of Autel's online user account.
- **Shopping** — displays questions and answers about online product purchase methods or procedures.
- **Payment** — displays questions and answers about online product payment methods or procedures.

# 11 Quick Link

The Quick Link application provides you with convenient access to Autel's official website and many other well-known sites in automotive service industry to provide technical help, knowledge bases, forums, and training and expertise consultations.

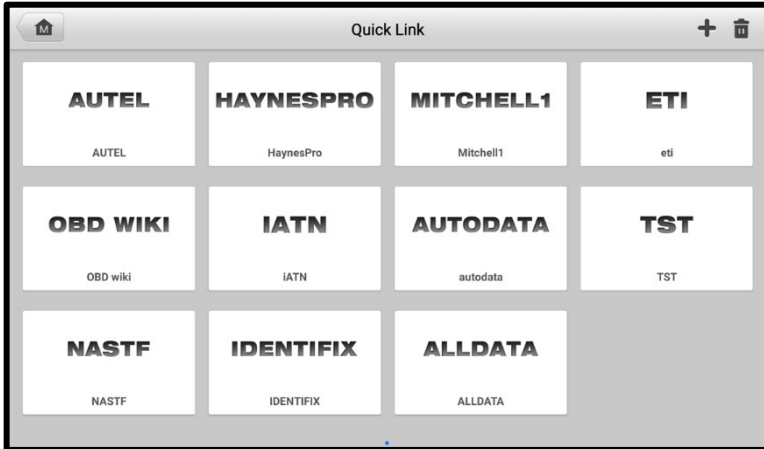

**Figure 11-1 Quick Link Screen**

➤ **To access a quick link**

1. Tap **Quick Link** on the MaxiCOM Job Menu. The Quick Link screen will appear.
2. Select a website thumbnail from the main section. The Chrome browser will be launched and the selected website will be opened.
3. Now you can start exploring the website.

➤ **To manage the quick links**

1. Tap **Quick Link** on the MaxiCOM Job Menu. The Quick Link application screen displays.
2. Tap the **+** icon on the upper-right corner to add websites. Tap the **🗑️** icon to delete websites.

# 12 MaxiViewer

The MaxiViewer application allows you to search the functions supported by our tools and the version information. There are two ways of searching, either by searching the product and the vehicle or searching the functions.

## ➤ To Search by the vehicle

1. Tap the **MaxiViewer** application on the MaxiCOM Job Menu. The Function Viewer screen displays.
2. Tap the tool name on the top-left corner to open the drop-down list. Tap the one you want to search.
3. Tap the vehicle brand, model, and year you want to search.

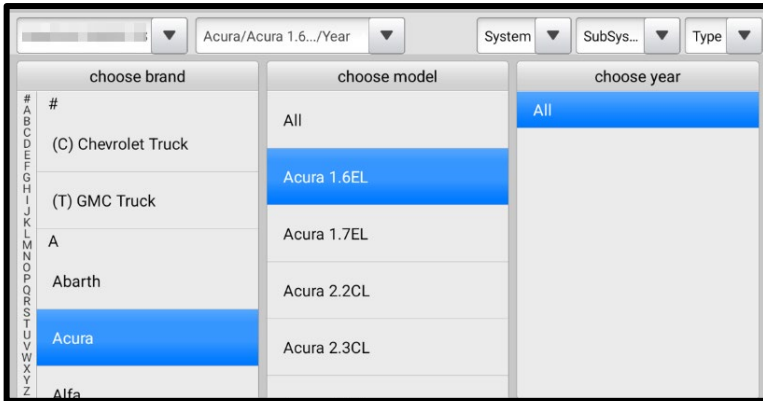

**Figure 12-1 Function Viewer Screen 1**

4. All the functions supported by the selected tool for the selected vehicle will display as several columns.

Year Range	Feature	Feature	Type	Function	Sub function	Version
/	SRS	/	Passenger car	ECU information	/	Above Acura_V2.10
/	SRS	/	Passenger car	Erase codes	/	Above Acura_V2.10
/	SRS	/	Passenger car	Freeze frame data	/	Above Acura_V2.10
/	SRS	/	Passenger car	Live data	/	Above Acura_V2.10
/	SRS	/	Passenger car	Read codes	/	Above Acura_V2.10

**Figure 12-2 Function Viewer Screen 2**

➤ **To search by the functions**

1. Tap the **MaxiViewer** application on the MaxiCOM Job Menu. The Function Viewer screen displays.
2. Tap the tool name on the top-left to open the drop-down list. Tap the one you want to search.
3. Type the function you want to search in the top-right search column. All the vehicles with this function will be listed with several columns, including system, function, sub function, and version.

Machinemodel	Model	Year Range	Feature	Feature	Function	Sub function	Version
Jaguar	F-Type	2014-2015	Passenger's door module	/	ECU information	/	Above Jaguar...
Jaguar	F-Type	2014-2015	Passenger's door module	/	ECU information	/	Above Jaguar...
Jaguar	F-Type	2014-2015	Transmission control module	/	ECU information	/	Above Jaguar...
Jaguar	F-Type	2014-2015	Transmission control module	/	ECU information	/	Above Jaguar...
Jaguar	F-Type	2014-2015	Body control module	/	ECU information	/	Above Jaguar...

**Figure 12-3 Function Viewer Screen 3**

---

 **NOTE**

Fuzzy search is supported, so type in part of the function you want to search can also find out all the related information.

---

# 13 MaxiVideo

The MaxiVideo application configures the MaxiCOM tablet to operate as a digital video scope by simply connecting the tablet to a MaxiVideo Digital Inspection Camera. This function allows you to examine difficult-to-reach areas normally hidden from sight, with the ability to record digital still images and videos, which offers you an economical solution to inspect machinery, facilities, and infrastructure in a safe and quick way.

---

## NOTE

1. The MaxiVideo Digital Inspection Camera and its fittings are additional accessories, and need to be purchased separately. Both sizes (8.5 mm and 5.5 mm) of the imager head are optional and available for purchase.
  2. This function is compatible with the MaxiVideo Digital Inspection Camera in models MV105S, MV108S, MV105, and MV108.
  3. Connect the tablet with MaxiVideo Digital Inspection Camera using the USB cable. For detailed operation instructions, please refer to the Quick Reference Guide for the MaxiVideo Digital Inspection Camera.
-

# 14 Autel User Center

Software updates are available for free for the first year from the date of purchase. The Autel User Center application allows you to register your tool to download the latest released software, thereby enhancing the functionality of the MaxiCOM application by adding new vehicle models or enhanced applications to the database.

There are two ways for product registration:

## A. Via the MaxiCOM tablet

### ➤ To log in with your account and register your tool

1. Tap **Autel User Center** from the MaxiCOM Job Menu. The following screen displays.

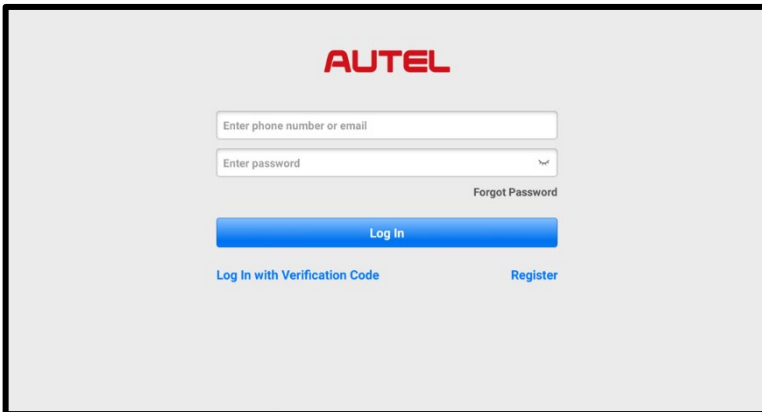

**Figure 14-1 Autel User Center Screen**

2. If you already have an Autel ID, you can log in with your phone number and verification code, or tap **Log In with Password** to log in with your Autel ID and password. If you don't have an Autel ID yet, tap **Register** to create an Autel ID.
3. Once your account is successfully registered, you will enter the main menu of the Autel User Center.
4. Select **Device Management** on the main menu.

5. Tap the **Link Device** button on the upper-right corner of the Device Management screen. The serial number and password of the device will automatically appear on the Link Device screen.
6. Tap the **Link** button to complete the product registration.

## **B. Via the Autel website**

### ➤ **To register your Autel tool**

1. Visit the website: [pro.autel.com](http://pro.autel.com).
2. If you have an Autel account, sign in with your account ID and password and skip to step 7.
3. If you are a new member to Autel, click the **Register** button to create your Autel ID.
4. Enter the required personal information in the input fields.
5. Enter your email address, then click **Request**. You will receive an email from Autel with your verification code. Open the email and copy the code into the proper input box.
6. Set a password for your account, and enter the password again to confirm. Read the **Autel User Service Agreement** and **Autel Privacy Policy**, then check the box to accept the terms. After all the information is entered, click **Register**. A Product Registration screen will appear.
7. Your product serial number and password are required to complete your registration. To find your serial number and password on the tool: go to **Settings > About**.
8. Enter your tool's serial number and password on the Product Registration screen. Enter the CAPTCHA code and click **Submit** to complete your registration procedure.

# 15 Maintenance and Service

To ensure that the MaxiCOM diagnostic tablet performs at its optimum level, we advise that the product maintenance instructions covered in this section is read and followed.

## 15.1 Maintenance Instructions

---

The following shows how to maintain your devices, together with precautions to take.

- Use a soft cloth and alcohol or a mild window cleaner to clean the touchscreen of the tablet.
- Do not use any abrasive cleansers, detergent, or automotive chemicals to the tablet.
- Maintain the devices in dry conditions and keep them within normal operating temperatures.
- Dry your hands before using the tablet. The touchscreen of the tablet may not work if the touchscreen is moist or if you tap the touchscreen with wet hands.
- Do not store the devices in humid, dusty or dirty areas.
- Check the housing, wiring, and connectors for dirt and damage before and after each use.
- After using the device, wipe the device housing, wiring, and connectors clean with a damp cloth.
- Do not attempt to disassemble your tablet.
- Do not drop or cause severe impact to the devices.
- Only use authorized battery chargers and accessories. Any malfunction or damage caused by the use of unauthorized battery charger and accessories will void the limited product warranty.
- Ensure that the battery charger does not come in contact with conductive objects.
- Do not use the tablet beside microwave ovens, cordless phones and some medical or scientific instruments to prevent signal interference.

## 15.2 Troubleshooting Checklist

---

### A. When the tablet does not work properly:

- Make sure the tablet has been registered online.

- Make sure the system software and diagnostic application software are properly updated.
- Make sure the tablet is connected to the Internet.
- Check all cables, connections, and indicators to see if the signal is being received.

**B. When battery life is shorter than usual:**

This may happen when you are in an area with low signal strength. Turn off your device if it is not in use.

**C. When you cannot turn on the tablet:**

Make sure the tablet is connected to a power source or the battery is charged.

**D. When you are unable to charge the tablet:**

- Your charger may be out of order. Contact the seller.
- You may be attempting to use the device in an overly hot/cold temperature. Try changing the charging environment.
- Your device may have not been connected to the charger properly. Check the connector.

---

 **NOTE**

If your problems persist, please contact Autel's technical support personnel.

---

## 15.3 About Battery Usage

---

Your tablet is powered by a built-in Lithium-ion Polymer battery. This means that, unlike other forms of battery technology, you can recharge your battery while some charge remains without reducing your tablet's autonomy due to the "battery memory effect" inherent in those technologies.

---

 **DANGER**

The built-in Lithium-ion Polymer battery is factory replaceable only; incorrect replacement or tampering with the battery pack may cause an explosion.

Do not use a damaged battery charger.

---

- Do not disassemble or open crush, bend or deform, puncture or shred.
- Do not modify or remanufacture, attempt to insert foreign objects into the battery, expose to fire, explosion or other hazards.
- Make sure to use the charger and USB cables only that come together in the package. If you use the other charger and USB cables, you might incur malfunction or failure of the device.

- Only use the charging device that has been qualified with device per the standard. Use of an unqualified battery or charger may present a risk of fire, explosion, leakage, or other hazards.
- Avoid dropping the tablet. If the tablet is dropped, especially on a hard surface, and the user suspects damage, take it to a service center for inspection.
- The closer you are to your network's base station, the longer your tablet usage time because less battery power is consumed for the connection.
- The battery recharging time varies depending on the remaining battery capacity.
- Battery life inevitably shortens over time.
- Since over charging may shorten battery life, remove the tablet from its charger once it is fully charged. Unplug the charger, once charging is complete.
- Leaving the tablet in hot or cold places, especially inside a car in summer or winter, may reduce the capacity and life of the battery. Always keep the battery within normal temperatures.

## 15.4 Service Procedures

---

This section introduces information for technical support, repair service, and application for replacement or optional parts.

### 15.4.1 Technical Support

If you have any question or problem on the operation of the product, please contact us (see the following contact info).

- **Phone:** +86 (0755) 8614-7779 (Monday-Friday, 9AM-6PM Beijing Time)
- **Email:** [support@autel.com](mailto:support@autel.com)
- **Address:** Floor 2, Caihong Keji Building, 36 Hi-tech North Six Road, Songpingshan Community, Xili Sub-district, Nanshan District, Shenzhen City, China
- **Web:** [www.autel.com](http://www.autel.com)

### 15.4.2 Repair Service

If it becomes necessary to return your device for repair, please download the repair service form from [www.autel.com](http://www.autel.com), and fill it in. The following information must be included:

- Contact name
- Return address

- Telephone number
  - Product name
  - Complete description of the problem
  - Proof-of-purchase for warranty repairs
  - Preferred method of payment for non-warranty repairs
- 

 **NOTE**

For non-warranty repairs, payment can be made with Visa, Master Card, or with approved credit terms.

---

Send the device to the below address:

Floor 2, Caihong Keji Building, 36 Hi-tech North Six Road, Songpingshan Community, Xili Sub-district, Nanshan District, Shenzhen City, China

### **15.4.3 Other Services**

You can purchase the optional accessories directly from Autel's authorized tool suppliers.

Your purchase order should include the following information:

- Contact information
- Product or part name
- Item description
- Purchase quantity

# 16 Compliance Information

## FCC Compliance

FCC ID: WQ8-DS900DV2231

This device complies with Part 15 of the FCC rules and Industry Canada's license-exempt RSSs. Operation is subject to the following two conditions:

1. This device may not cause harmful interference.
2. This device must accept any interference received, including interference that may cause undesired operation.

Cet appareil est conforme aux CNR exempts de licence d'Industrie Canada. Son fonctionnement est soumis aux deux conditions suivantes:

1. Ce dispositif ne peut causer des interférences; et
2. Ce dispositif doit accepter toute interférence, y compris les interférences qui peuvent causer un mauvais fonctionnement de l'appareil.

---

### WARNING

Changes or modifications not expressly approved by the party responsible for compliance could void the user's authority to operate the equipment.

---

### NOTE

This equipment has been tested and found to comply with the limits for a Class B digital device, pursuant to Part 15 of the FCC Rules. These limits are designed to provide reasonable protection against harmful interference in a residential installation.

---

This equipment generates, uses and can radiate radio frequency energy and, if not installed and used in accordance with the instructions, may cause harmful interference to radio communications. However, there is no guarantee that interference will not occur in a particular installation. If this equipment does cause harmful interference to radio or television reception, which can be determined by turning the equipment off and on, the user is encouraged to try to correct the interference by one or more of the following measures:

- Reorient or relocate the receiving antenna.
- Increase the separation between the equipment and receiver.
- Connect the equipment into an outlet on a circuit different from that to which the receiver is connected.
- Consult the dealer or an experienced radio/TV technician for help.

Changes or modifications not expressly approved by the party responsible for compliance could void the user's authority to operate the equipment.

## **SAR**

The radiated output power of this device is below the FCC radio frequency exposure limits. Nevertheless, the device should be used in such a manner that the potential for human contact is minimized during normal operation.

The exposure standard for wireless devices employs a unit of measurement known as the Specific Absorption Rate, or SAR. The SAR limit set by the FCC is 1.6 W/Kg. Tests for SAR are conducted using standard operating positions accepted by the FCC with the device transmitting at its highest certified power level in all tested frequency bands.

Although the SAR is determined at the highest certified power level, the actual SAR level of the device while operating can be well below the maximum value. This is because the device is designed to operate at multiple power levels so as to use only the power required to reach the network. To avoid the possibility of exceeding the FCC radio frequency exposure limits, human proximity to antenna should be minimized.

## **RF WARNING STATEMENT**

The device has been evaluated to meet general RF exposure requirement. The device can be used in portable exposure condition without restriction.

The term "IC" before the radio certification number only signifies that IC technical specifications were met.

## **RoHS COMPLIANCE**

This device is declared to be in compliance with the European RoHS Directive 2011/65/EU.

## **CE COMPLIANCE**

This product is declared to conform to the essential requirements of the following Directives and carries the CE mark accordingly:

RED Directive 2014/53/EU

# 17 Warranty

## 17.1 Limited One Year Warranty

---

Autel Intelligent Technology Corp., Ltd. (the Company) warrants to the original retail purchaser of this MaxiCOM Diagnostic Device, that should this product or any part thereof during normal consumer usage and conditions, be proven defective in material or workmanship that results in product failure within one (1) year period from the date of purchase, such defect(s) will be repaired, or replaced (with new or rebuilt parts) with Proof of Purchase, at the Company's option, without charge for parts or labor directly related to the defect(s).

---

### NOTE

If the warranty period is inconsistent with local laws and regulations, please comply with the relevant local laws and regulations.

---

The Company shall not be liable for any incidental or consequential damages arising from the use, misuse, or mounting of the device. Some states do not allow limitation on how long an implied warranty lasts, so the above limitations may not apply to you.

#### **This warranty does not apply to:**

- a) Products subjected to abnormal use or conditions, accident, mishandling, neglect, unauthorized alteration, misuse, improper installation or repair or improper storage;
- b) Products whose mechanical serial number or electronic serial number has been removed, altered or defaced;
- c) Damage from exposure to excessive temperatures or extreme environmental conditions;
- d) Damage resulting from connection to, or use of any accessory or other product not approved or authorized by the Company;
- e) Defects in appearance, cosmetic, decorative or structural items such as framing and non-operative parts;
- f) Products damaged from external causes such as fire, dirt, sand, battery leakage, blown fuse, theft or improper usage of any electrical source.

---

**! IMPORTANT**

All contents of the product may be deleted during the process of repair. You should create a back-up copy of any contents of your product before delivering the product for warranty service.

---

**AUTEL<sup>®</sup>**

V2.3 | 2026.04.17