

**HYUNDAI**  
POWER PRODUCTS

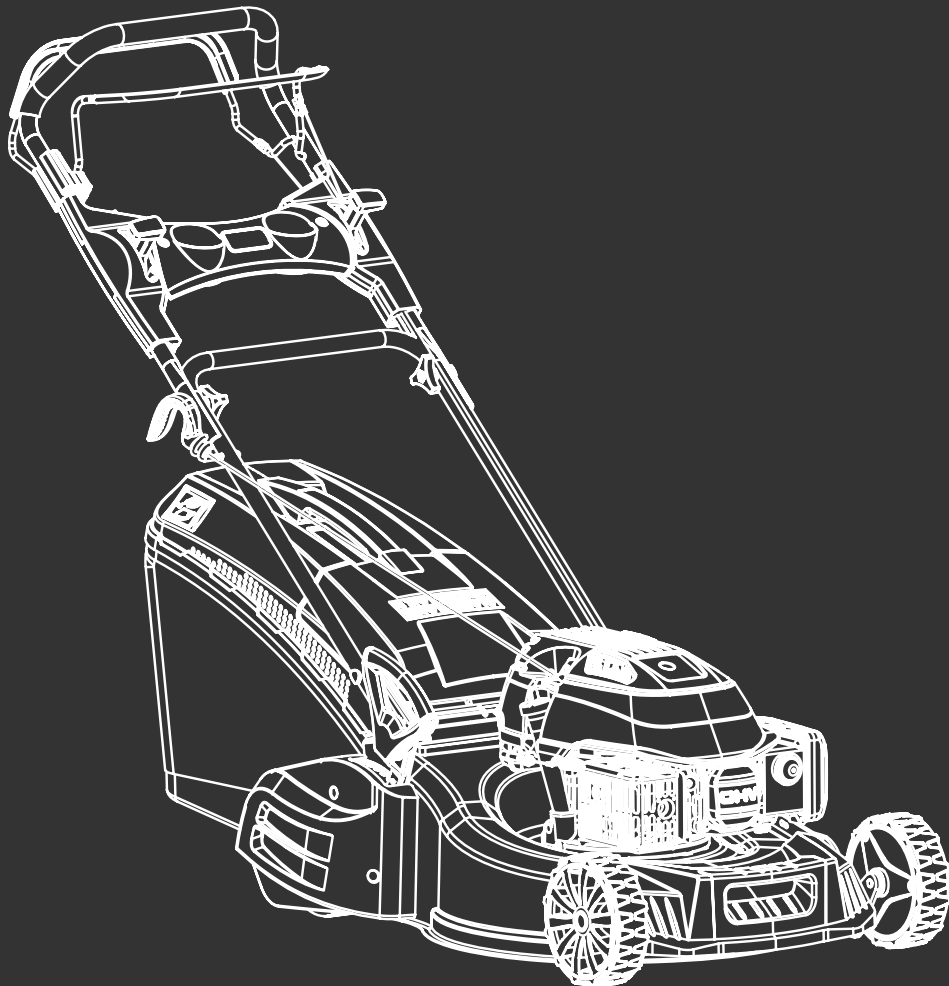

# PETROL ROLLER LAWNMOWER HYM530SPR

Instruction Manual



# Introduction

## Thank You For Purchasing Your HYUNDAI Product

We work very hard to give all of our customers the best possible service. If you have any problems, before leaving negative feedback, please contact us to give us a chance to resolve the issue. We would be delighted if you left us positive feedback! Thank you for purchasing this product.

## Important!



**⚠ WARNING : READ THE INSTRUCTION BOOKLET THOROUGHLY BEFORE USING THE MACHINE.** Keep for future reference and pass it on if the machine is loaned or sold to another user.

This manual has been produced by Hyundai Power Products and should be kept with the product. Please read and understand these instructions before you use your product. Failure to do this may result in personal injury or damage to the product.

The safety precautions and warnings are to ensure your safety and protect you from harm or damage to the product.

The information contained in this manual was accurate at the time of production, however HYUNDAI Power Products may make modifications to the product without notification.



# Contents

<b>Safety Information.....</b>	<b>4-19</b>	<b>Maintenance.....</b>	<b>39-49</b>
Understand Your Machine.....	4	Maintenance Safety.....	39
Personal Safety.....	5	Checking Your Machine.....	39
Inspect Your Machine.....	6	Cleaning.....	40-41
Work Area.....	7	Transportation.....	41
During Use.....	8-9	Storage.....	42-43
Engine Safety.....	10	Blade Maintenance.....	44
Carbon Monoxide.....	11	Air Filter.....	45
Fuel Safety.....	12-13	Spark Plug.....	46
Batteries.....	14	Cleaning / Draining Oil.....	47
Electrical Safety.....	15	Fuel And Carburetor.....	47
Vibrations.....	16	OPC Cable Adjustment.....	48
Noise.....	16	Drive Cable Adjustment.....	49
Personal Protective Equipment.....	17	<b>Troubleshooting.....</b>	<b>50</b>
Intended Use.....	18	<b>Technical Data.....</b>	<b>51</b>
Symbols On The Machine.....	19	<b>Spare Parts.....</b>	<b>52-59</b>
<b>Features.....</b>	<b>20-21</b>	<b>Notes.....</b>	<b>60-61</b>
<b>Unboxing.....</b>	<b>22</b>	<b>Recycling And Disposal.....</b>	<b>62</b>
<b>Assembly.....</b>	<b>23-29</b>	<b>Declaration Of Conformity.....</b>	<b>63</b>
Assembly Safety.....	23	<b>Useful Information.....</b>	<b>64</b>
Assemble Handlebars.....	24-25	Our YouTube Channel.....	64
Grass Collector Assembly.....	26	Warranty.....	64
Attaching Grass Collector.....	27	Manual Updates.....	64
Cable Attachment.....	28	Returning Your Product.....	64
Cable Clips.....	29	Leaving A Review.....	64
Attach Central Panel.....	29	Ordering Spare Parts.....	64
<b>Preparation.....</b>	<b>30-31</b>	<b>Our Product Range.....</b>	<b>65</b>
Before Each Use.....	30	<b>Product Information.....</b>	<b>66</b>
Adding Oil.....	30	Service Record.....	66
Checking Oil Level.....	30	<b>Contact Us.....</b>	<b>67</b>
Adding Fuel.....	31		
<b>Operation.....</b>	<b>32-35</b>		
Cutting Height Adjustment.....	32		
Rear Discharge.....	33		
Creating Stripes.....	34		
General Mowing Tips.....	35		
Recommended Mowing Schedule.....	35		
<b>Starting / Stopping.....</b>	<b>36-38</b>		



# Safety Information

## Safety

No list of safety guidelines can be complete. Every environment is different. Always consider safety first, as it applies to your individual working conditions. Use this and other machinery with caution and respect. Failure to do so could result in serious injury, damage to equipment, or poor work results.

Some or all of the following - warning signs and symbols may appear throughout this manual. You **MUST** adhere to their warnings. Failure to do so may result in personal injury to yourself or those around you.

### **DANGER**

Indicates a hazard, which, if not avoided, could result in serious injury or death.

### **WARNING**

Indicates a hazard, which, if not avoided, could result in serious injury.

### **CAUTION**

Indicates a hazard which, if not avoided, might result in minor or moderate injury.

## Understand Your Machine

- **WARNING!** You must read these instructions carefully before operating the machine. Make sure that you are familiar with the controls and properly operate the machine. You must learn how to stop the machine quickly. If you do not follow the warnings and instructions, it may result in fire and/or serious injury. Make sure to save all warnings and instructions for future reference.
- Read this manual and labels affixed to the machine to understand its limitations and potential hazards.
- Be thoroughly familiar with the controls and their proper operation. Know how to stop the machine and disengage the controls quickly.
- If the unit is to be used by someone other than original purchaser, or is to be loaned, rented, or sold, always provide this manual and any needed safety training before operation. The user can prevent and is responsible for accidents or injuries that may occur to themselves, to other people, or to property.
- Do not force the machine beyond its limits. Use the correct machine for your application.
- Know how to stop the machine quickly in case of emergency. Understand the use of all controls.
- **ALL MAINTENANCE** other than that listed in this manual, should be carried out by professionally trained and certified personnel.
- When using this machine for the first time and before actual work, you **MUST** learn how to handle the machine from an experienced or skilled person.



# Safety Information

## ⚠ Personal Safety

- **WARNING!** Never allow children or people unfamiliar with these instructions to use the product. Local regulations can restrict the minimum age of the operator.
- Keep children, pets, and other people not using the unit away from the work area (at least 15m). Be alert and shut off the unit if anyone enters work area. Keep children under the watchful care of a responsible adult.
- Stay alert, watch what you are doing and use common sense when operating the machine. Never operate the machine when unwell or tired, or if you have taken alcohol, medicine, drugs or any substances which may slow your reflexes and compromise judgment. A moment of inattention while operating the machine may result in serious personal injury.
- Appropriate Personal Protective Equipment (PPE), **MUST** be worn at all times when operating or repairing the machine. Always wear anti-slip and resistant work footwear and long trousers while using the machine. Do not use the machine when barefoot, wearing sandals or similar lightweight footwear. Do not wear chains, bracelets or clothing that is loose fitting or hanging ties or cords. Tie long hair back. Always wear protective earplugs. Loose clothes, jewellery, or long hair can be caught in moving parts. Protect eyes, face, and head from objects that may be thrown from the unit. Always wear safety goggles or safety glasses with side shields when operating.
- Always keep hands and feet away from all moving parts during operation. Moving parts can cut or crush body parts. Always keep hands and feet away from all pinch points.
- Do not touch parts that might be hot from operation. Allow parts to cool before attempting to maintain, adjust, or service.
- Do not overreach. Keep proper footing and balance at all times. This enables better control of the machine in unexpected situations. Extending your body too far can result in a loss of balance and you may fall which will result in injury.
- Never place any part of your body where it would be in danger if movement should occur during assembly, installation, and operation, maintenance, repairing or moving.
- Start the machine carefully according to instructions and with feet away from the moving parts.
- Do not place your hands or feet near or under rotating parts. Keep away from any discharge openings.
- Keep in mind that the operator or user is responsible for accidents, hazards or unexpected events involving the machine that occur to other people or their property. It is the responsibility of the user to assess the potential risk of the area where work is being carried out. The operator or user must take all necessary precautions to ensure their own safety and that of others, especially on slopes or rough, slippery and unstable ground.



# Safety Information

## **▲ Inspect Your Machine**

- Check your machine before starting it. Keep guards in place and in working order. Make sure all nuts, bolts, etc., are securely tightened.
- You must check the general condition of the machine before use.
- Never operate the machine when it is in need of repair or is in poor mechanical condition. Replace damaged, missing, or failed parts before using it. Check for fuel leaks. Keep the machine in safe working condition.
- Do not use the machine if the engine's switch does not turn off the engine when running. Any petrol powered machine that can't be controlled with the engine switch is dangerous and must be replaced.
- Regularly check to see that keys and adjusting wrenches are removed from the machine area before starting it. A wrench or a key that is left attached to a rotating part of the machine may result in personal injury.
- If the machine should start to vibrate abnormally, stop the engine and check immediately for the cause. Vibration is generally a warning sign of trouble.
- Avoid accidental starting. Be sure the engine's switch is off before transporting the machine or performing any maintenance or service on the unit. Transporting or performing maintenance or service on a machine with its switch on invites accidents.
- Do not tamper with or disable safety systems.
- Only use manufacturer-recommended attachments.
- Before using, always visually inspect to see that the tools are not worn out or damaged. Replace worn out or damaged elements and bolts in set to preserve balance.
- Keep the machine in good operating condition. Operating the machine in poor or questionable condition could result in serious injury.
- Be sure all safety devices are in working order and warning labels are in place. These items are installed for your safety.



# Safety Information

## ▲ Work Area

- Make sure you thoroughly inspect the entire work area and remove all objects and anything that could be thrown by the machine or could damage the engine or machine (branches, stones, wire, toys, etc). Attempting to clear the work area whilst using the machine will reduce your concentration and creates a trip hazard. Any liquid spilled on the floor may result in you slipping.
- You must only work in daylight or with good artificial light in good visibility conditions. Do not work at night, at times of heavy fog, or at any other times when your field of vision might be limited and it would be difficult to gain a clear view of the area.
- Keep people, children and animals away from the working area.
- Operate on flat, level ground.
- DO NOT work on wet ground. If there has been heavy rain on the working site, wait until the ground has dried up.
- You must pay special attention when approaching obstacles that could compromise visibility.
- Exercise extreme caution when changing direction on slopes. When changing direction, you need to be careful that the wheels do not hit any obstacles (such as roots, branches, stones, etc) that can cause the machine to slide sideways or make you lose control of it. Avoid driving on slopes steeper than 15%. Make sure on slopes you have a steady foothold.
- Find and locate all fixed objects in the ground, such as sprinkler systems, poles, water valves, bases for washing lines etc. Make sure that you check for hidden electrical cables or similar on the surface of the lawn. ALWAYS run the machine around these objects. NEVER intentionally run the machine over foreign objects.
- Never park the machine in a place with unstable ground which could give way.
- You must be careful near ravines, ditches or embankments.
- Exercise extreme caution when operating on or crossing gravel drives, walks, or roads. Stay alert for hidden hazards or traffic.
- Pay the utmost attention when working on frozen ground as the machine may tend to skid.
- Do not work in the rain, when there is a thunderstorm or lightning risk, at times of strong or gale force winds, or at any other times when the weather conditions might make it unsafe to use this product. If there is bad weather conditions, do not use the machine.

# Safety Information

## During Use

- Always hold the unit with both hands when operating. Keep a firm grip on the handlebars. Be aware that the machine may unexpectedly bounce upward or jump forward if the machine should strike buried obstacles such as large rocks or roots.
- Do not operate the machine in confined areas where there may be a risk of crushing the operator between the machine and another object.
- Walk, never run with the machine. Be very careful when pulling the machine toward you. You must look behind you to make sure there are no obstacles before and during operations in reverse gear (if applicable). Do not allow the machine to pull you along.
- **WARNING!** If something breaks or an accident happens whilst working, you must turn off the engine immediately and move the machine away to prevent further damage. If an accident happens with injuries or third parties are injured, carry out the first aid measures most suitable for the situation immediately and contact the medical authorities for any necessary health care. Carefully remove any debris that might cause damage or harm persons or animals should it not be seen.
- Disengage clutch lever before starting the engine.
- Use extreme caution when reversing or pulling the machine backwards.
- Do not carry passengers.
- Never operate the machine at a fast pace.
- The excessive speed of movement or the absence of maintenance have a significant influence on noise emissions and vibrations. It is necessary to take preventive steps to eliminate possible damage due to high levels of noise and stress from vibration. You must maintain the machine well, wear ear protection and take breaks from working.
- After striking a foreign object, stop the engine immediately, remove the spark plug cap and inspect the machine thoroughly for damage. Repair the damage before continuing.
- Never attempt to make any adjustments, while the engine is running.
- Never attempt to move the machine in any way other than intended for normal use while the engine is running.
- Factory-fitted control devices, such as the handle-mounted clutch cable, must not be removed or exposed.



# Safety Information

## **⚠ During Use (Continued)**

- You must disengage the blade, switch off the engine and unplug the spark plug cable (making sure that all moving parts are stationary):
  - Before refuelling.
  - Before adjusting the cutting height.
  - After striking a foreign object, you must inspect the machine for damage and make repairs before using it again.
  - Before checking or working on the machine.
  - Before clearing blockages.
  - When transporting the machine.
  - Whenever you leave the machine unattended.
  - When crossing surfaces other than grass.
  - Before emptying the grass collector.
  - Before changing the cutting height.



# Safety Information

## ⚠ Engine Safety

- This machine is equipped with an internal combustion engine. Do not use on, or near, forest-covered or brush-covered land unless the exhaust system is equipped with a spark arrester meeting applicable local, state, or federal laws.
- A spark arrester, if used, must be maintained in effective working order by the operator.
- Never start or run the engine inside a closed area. The exhaust fumes are dangerous, containing carbon monoxide, an odorless and deadly gas. Operate this unit only in a well-ventilated outdoor area. (See carbon monoxide safety).
- Do not tamper with the engine in an effort to get it to run at higher speeds. The maximum engine speed is preset by the manufacturer and is within safety limits.
- Keep a fire extinguisher on hand when operating this machine in dry areas as a precautionary measure.
- Never leave the operating position when the engine is running.
- The engine parts get very hot when running, do not touch. Danger of burns.
- Follow the instructions to ignite the engine carefully whilst keeping feet away from moving parts.
- Never incline the machine during ignition. Ignite the machine on a flat surface without obstacles or high grass.
- Do not over-rev the engine or change the engine settings.
- Never pick up or carry the machine while the engine is running.
- Stop the engine whenever you leave the machine, or before refuelling, when cleaning or while maintaining.
- Reduce the throttle setting during engine shut down and, if the engine is provided with a shut-off valve, turn the fuel off at the conclusion of working.
- Do not tilt the lawnmower when starting the engine.



# Safety Information

## ⚠ Carbon Monoxide

### ⚠ DANGER!

Engine exhaust fumes contain Carbon Monoxide. This is a poisonous gas and can kill in minutes. **NEVER** use inside a building or in an area with poor ventilation. **NEVER** use inside a confined space, such as but not limited to a house, garage, vehicle, boat or tent. **ONLY** use outside and far away from windows, doors and vents.

**CARBON MONOXIDE IS A COLOURLESS, ODOURLESS GAS. INHALING THIS GAS CAN CAUSE DEATH OR SERIOUS LONG-TERM HEALTH PROBLEMS SUCH AS BRAIN DAMAGE.**

Never operate the engine in a confined space where dangerous carbon monoxide fumes can develop. All ignition operations have to be effected in an open or well-ventilated area. Always remember that exhaust fumes are toxic.

The symptoms of carbon monoxide poisoning can include but are not limited to the following; Headaches, dizziness, nausea, breathlessness, collapsing or loss of consciousness.

Carbon monoxide poisoning symptoms are similar to flu, food poisoning, viral infections and simply tiredness. It is quite common for people to mistake this very dangerous poisoning for something else.

To avoid carbon monoxide poisoning **DO NOT** use Petrol/Diesel powered equipment inside any of the following; Home, garage, tent, camper van, mobile home, caravan or boat. **DO NOT** use in an enclosed area or moving vehicle. This is not exhaustive and if you are in any doubt contact your dealer.

If you think you have or someone around you has been affected by carbon monoxide poisoning; Get them fresh air immediately, by leaving the affected area or by opening doors and windows. If safe and practical to do so make sure that the machine is turned off. **DO NOT** enter a room you suspect of having carbon monoxide present – instead call the emergency services.

Contact a Doctor immediately or go to Hospital – let them know that you suspect carbon monoxide poisoning.



# Safety Information

## ⚠ Fuel Safety



**CAUTION! ALL FUELS ARE HIGHLY FLAMMABLE AND PETROL VAPOUR IS EXPLOSIVE. TAKE EXTREME CARE WHEN HANDLING FUEL. KEEP FUEL OUT OF REACH OF CHILDREN.**

## General Safety

- Do not smoke each time fuel is handled.
- ALWAYS avoid inhaling fumes.
- ALWAYS carry fuel in the correct and clearly marked container.
- ALWAYS wear correct, suitable and fit for purpose Personal Protective Equipment (PPE), suggested items are but not limited to safety gloves and overalls.
- To avoid sparking or arcing, keep grounded conductive objects – such as tools – away from exposed, live electrical parts and connections. These events could ignite fumes or vapors.
- Do not operate the machine with known leaks in the fuel system.
- Fire hazard - keep fuel away from all sources of ignition for example heaters, lamps, sparks from grinding or welding.
- DO NOT carry out hot work on tanks that have contained fuel.
- ALWAYS keep the work area tidy.
- ALWAYS dispose of waste fuels correctly.
- Serious personal injury can occur when petrol is spilled on yourself or your clothes. Rinse your skin and change your clothes immediately.

## Spilled Fuel

- If you have spilled fuel, make sure you do not attempt to ignite the engine but move the machine away from the area of spilled fuel and avoid creating any source of ignition until the fuel has evaporated and fuel vapours have dissipated.
- When fuel is spilled on yourself or your clothes, wash your skin and change clothes immediately.
- ALWAYS clean up spills promptly using absorbent granules and a lidded bin.



# Safety Information

## Fueling / De-Fueling

- ALWAYS fuel and de-fuel in a well ventilated area outside of buildings. Use a funnel to add fuel, only outdoors. Do not smoke during this and each time fuel is handled.
- Add fuel before igniting the engine, never remove the fuel tank cap or add fuel whilst the engine is running or when it is hot.
- When de-fueling ALWAYS use a proper fuel retriever.
- Never overfill the fuel tank. Engine heat can cause fuel to expand, never fill the tank to more than 1/2" below the bottom of the filler neck. This will provide space for fuel expansion.
- When refilling or draining the fuel tank, use an approved fuel storage container while in a clean, well-ventilated outdoor area. While adding fuel or operating the unit, do not smoke, and stay away from sparks, open flames, or other sources of ignition near the area of operation.
- Always stop the engine and allow it to cool before filling the fuel tank. Never remove the cap of the fuel tank or add fuel while the engine is running or when the engine is hot.
- Loosen the fuel tank cap slowly to relieve any pressure in the tank.
- ALWAYS keep the handles dry, clean and free of oil and fuel.
- After fueling, ensure to tighten the cap securely.
- Never use the lock-function when filling with fuel.

## Storage

- Store fuel in containers specifically designed and approved for fuel storage.
- Store fuel in a cool, well-ventilated area, safely away from sparks, open flames, or other sources of ignition.
- Never store fuel – or a machine with fuel in the tank – inside a building where fumes may reach a spark, open flame, or any other source of ignition (such as a water heater, furnace, or clothes dryer). Allow the engine to cool before storing in any enclosure.
- Replace all fuel tank and container caps securely and wipe up spilled fuel. Never operate the unit without the fuel cap securely in place.



# Safety Information

## ⚠ Batteries (Where Present)

Batteries present a risk if they become damaged by the possible leaking of electrolyte. This electrolyte is an acid and can cause serious burn injuries. Care should be taken when working on or near them. **NOTE** the electrolyte may be in a liquid or gel form.

Should you come in to contact with electrolyte you should;

- Remove all clothing contaminated with electrolyte. If you cannot remove then saturate them in water.
- Get medical assistance as soon as possible.

You must advise the medical staff of the type of acid.

- Lead/acid battery = dilute sulphuric acid.
- Nickel/cadmium = potassium hydroxide alkali electrolyte.
- Use fresh running water to wash off excess electrolyte, continue this until medical assistance arrives. Make sure that you do not wash the electrolyte to another part of your body or face.
- If electrolyte comes in to contact with Eyes the electrolyte needs to be immediately washed away with large amounts of water. Make sure that you do not wash the electrolyte to another part of your face or body.
- Gasses from charging batteries are highly flammable and great care should be taken to charge in well ventilated areas.
-  There is an explosion risk if the battery terminals are short circuited, when connecting/disconnecting ALWAYS exercise great care so that the terminals or battery leads are NOT allowed to touch and cause a spark. ALWAYS use suitable insulated tools.



# Safety Information

## ⚠ Electrical Safety (Where Applicable)



**DANGER!**

**ELECTRICITY CAN KILL - NEVER WORK ON LIVE/ENERGISED EQUIPMENT.**

- Prior to carrying out any maintenance work you **MUST** identify electrical isolation methods and isolate all electrical supplies.
- Prior to use and with all electrical supplies isolated, you **MUST** check all electrical cables, plugs and connectors for the following;
  - Are intact and have no signs of damage, to include but not limited to bare wires, chaffing, cuts and loose wiring.
  - If there are any signs of damage, the damaged item **MUST** be taken out of service until the damage has been repaired by an electrically competent person.
  - All trailing cables should be routed so as not to cause any kind of trip hazard.
  - **NEVER** work on or near electricity with wet hands, wet clothing and wet gloves.



# Safety Information

## ⚠ Vibrations (Where Applicable)

- Prolonged use of hand held (operated) machines will cause the user to feel the effects of/from vibrations. These vibrations can lead to white finger (Raynaud's phenomenon) or carpal tunnel syndrome. This condition reduces the ability of the hand to feel and regulate temperature, causing numbness and heat sensations and may cause nerve damage and circulatory tissue death.
- Not all factors that lead to white finger disease are known, but cold weather, smoking and other diseases that affect blood vessels and blood circulation as well as large and long-lasting impact of shocks are considered factors in the formation of white finger. Note the following to reduce the risk of white finger and carpal tunnel syndrome;
  - Wear gloves and keep your hands warm.
  - Take regular breaks.
  - All of the above precautions may help reduce the risk of white finger disease but not rule out the carpal tunnel syndrome. Long-term and regular users are therefore recommended to observe the condition of your hands and fingers. Seek medical attention immediately if any of the above symptoms should occur.

## ⚠ Noise (Where Applicable)

- The operating noise of the machine can damage your hearing. When wearing protection such as earplugs or ear defenders to protect your hearing. Long-term and regular users are advised to have hearing checked regularly. Be especially vigilant and cautious when wearing ear protection because your ability to hear alarm warnings will be reduced.
  - Noise emissions for this equipment is unavoidable. Carry out noisy work at approved times and for certain periods. Limit the working time to a minimum. For your personal protection and protection of people working nearby it is also advisable for them to wear hearing protection.
-  • See Certificate of Conformity section for Outdoor Noise declaration of conformity.



# Safety Information

## ⚠ Personal Protective Equipment

**Appropriate Personal Protective Equipment (PPE), MUST be worn at all times when operating or repairing the machine. No protective equipment can ensure 100% protection.**

When selecting PPE, make sure it's CE marked and it suits the user in terms of size, fit, etc. If more than one item of PPE is worn at the same time, make sure they can be used together, e.g. wearing safety glasses may disturb the seal of a respirator, causing air leaks.



### **HAND PROTECTION MUST BE WORN**

Protective electrically non-conductive gloves are highly recommended when working.



### **FOOT PROTECTION MUST BE WORN**

Non-skid heavy duty footwear are highly recommended when working.



### **HEARING PROTECTION MUST BE WORN**

Suitable safety hearing protection is recommended.



### **EYE PROTECTION MUST BE WORN**

Always wear safety glasses/goggles and/or face shields. Everyday eyeglasses have only impact resistant lenses; they are not safety glasses/goggles.



### **PROTECTIVE CLOTHING MUST BE WORN**

Do not wear loose clothing, gloves, scarfs, neckties or jewellery (rings, wrist watches), which can be caught in moving parts.



### **HEAD PROTECTION MUST BE WORN**

Wear a safety helmet with a safety visor.



### **FACE SHIELD MUST BE WORN**

Wear a face shield to protect your face.



### **RESPIRATOR MUST BE WORN**

Wear a respirator.



# Safety Information

## Intended Use

The HYM530SPR is a petrol powered rear roller, self-propelled lawnmower from HYUNDAI, ideally suited for medium to large sized lawns. The HYM530SPR has a cutting width of 525mm and is powered by a 196cc 4-stroke OHV petrol engine.

The lawnmower is a garden tool and precisely a pedestrian controlled lawnmower. The machine is essentially composed of an engine which drives a blade enclosed in a casing, equipped with wheels and a handle. The operator is able to operate the machine and use the main controls, always staying behind the handle at a safe distance from the rotating blade. If the operator leaves the machine, the engine and cutting means will stop within a few seconds.

The lawnmower is manufactured according to the latest safety requirements. These include a blade brake that stops the engine and blade when you let go of the OPC lever. Every precaution is only effective when it is followed exactly.

### Intended Use

This machine was designed and manufactured for cutting and collecting grass in gardens and grassy areas, in areas in proportion to its cutting capacity, controlled by a pedestrian operator.

The presence of attachments or specific devices can prevent cut grass from being collected or produce a mulching effect, depositing cut grass on the ground.

### User Types

This machine is intended for use by consumers, i.e. non professional operators. The machine is intended for "DIY" and domestic use only.

### Improper Use

Any other usage not in keeping with the above mentioned ones may be hazardous and harm persons and/or damage things. Examples of improper use may include, but are not limited to:

- transporting people, children or animals on the lawnmower
- letting yourself be transported by the lawnmower
- using the machine to tow or push loads
- using the machine for leaf or debris collection
- using the machine to trim hedges, or cutting anything other than grass
- use of the machine by more than one person
- using the blade on surfaces other than grass



# Safety Information

## Symbols On The Machine

We have provided safety messages in this manual and on the machine. This information alerts you to potential hazards that could hurt you or others. Please read these messages carefully. However, we may not have listed all of the possible hazards, you must also use your own judgment.

 <p><b>IMPORTANT</b> Please read the instruction manual carefully, especially the safety warnings marked with this symbol.</p>	 <p><b>UNATTENDED UNIT</b> Always disengage the levers, turn off the engine, and remove the spark plug, when the unit is left unattended.</p>
 <p><b>INSTRUCTION MANUAL</b> Read and understand operator's manual before using the machine. Failure to follow instructions could result in death or serious injury.</p>	 <p><b>DANGER!</b> Keep hands and feet away from cutting parts.</p>
 <p><b>SAFETY DISTANCE</b> Do not put hands or feet near or under rotating parts. Keep a 15 metre safety distance.</p>	 <p><b>WARNING!</b> Always use correct tools and original spare parts.</p>
 <p><b>BYSTANDERS</b> Never allow any bystanders in front of the unit. Keep a 15 metre safety distance.</p>	 <p><b>WARNING!</b> Stop the engine before cleaning the work area.</p>
 <p><b>ROTATING PARTS</b> The rotating parts are capable of amputating fingers, toes and feet. Failure to observe could result in serious injury or death.</p>	 <p><b>KEEP BYSTANDERS AWAY!</b> Keep bystanders, especially children and pets away!</p>
 <p><b>WARNING</b> Do not touch the rotating parts.</p>	 <p><b>PROTECT FROM MOISTURE</b> Do not expose the product to rain or wet conditions.</p>
 <p><b>DO NOT USE ON SLOPES</b> Do not use on slopes above 15°.</p>	 <p><b>CE SYMBOL</b> This product complies with the applicable European directives and an evaluation method of conformity for these directives was done.</p>

# Features

## HYM530SPR Features

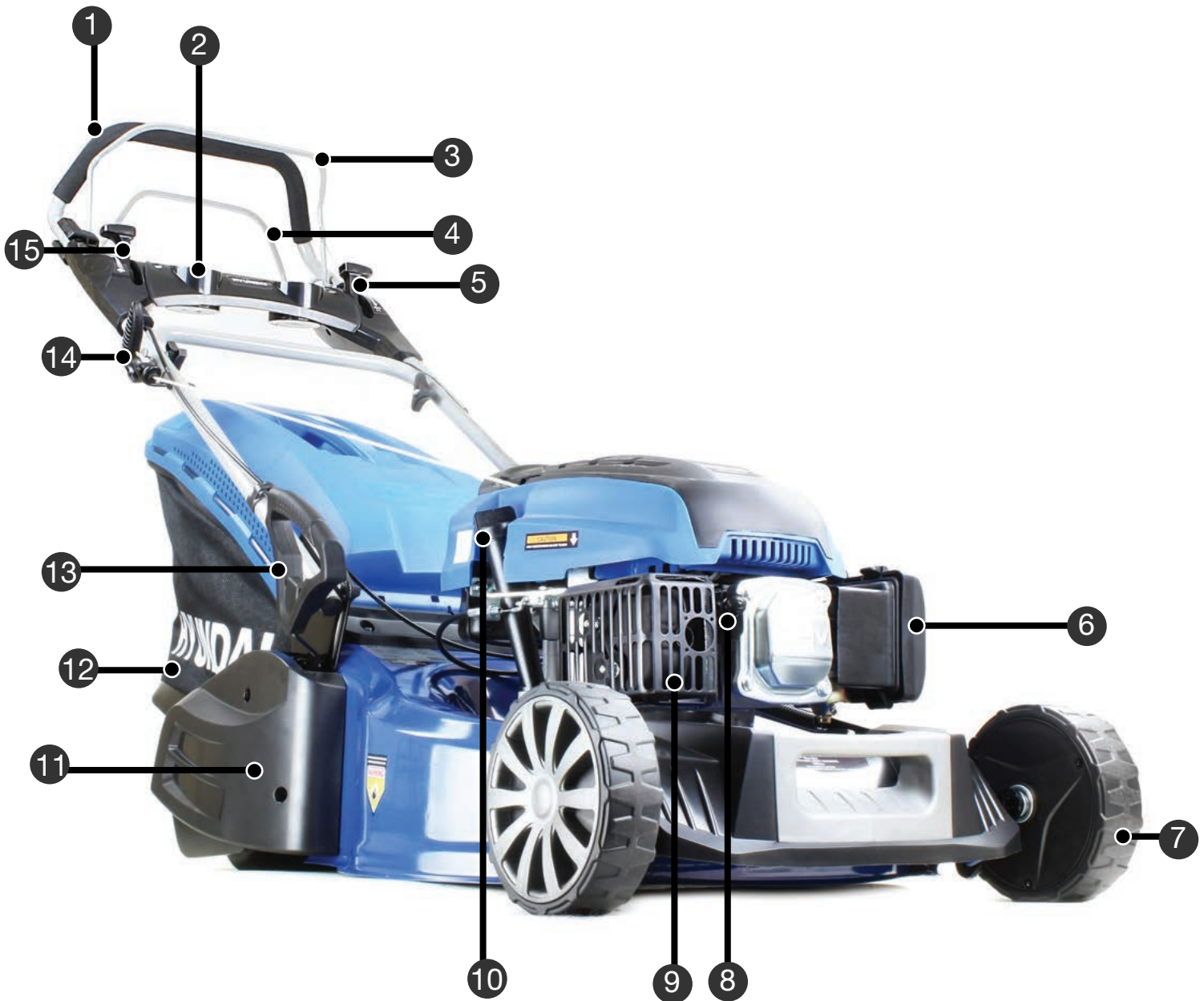

# Features

## HYM530SPR Features

- 1 Upper Handle**  
Hold onto with both hands this whilst using the machine.
- 2 Central Panel With Drink Holders**
- 3 Operator Presence Control (OPC) Lever**  
This is a safety feature. The machine will stop if you let go of this lever.
- 4 Self Propelled Lever**  
Propels the machine forward. All you have to do is control the path the machine takes.
- 5 Choke Lever**
- 6 Air Filter**  
Prevents dust, dirt and other contaminants from getting into the engine.
- 7 Wheel**
- 8 Spark Plug**
- 9 Exhaust**  
This will get very hot. Do not touch.
- 10 Oil Filler**  
Fill oil here.
- 11 Rear Roller**  
This will create the traditional striped lawn effect.
- 12 Grass Collector**  
This collects the grass whilst you mow.
- 13 Cutting Height Adjustment Lever**  
You can choose different cutting heights.
- 14 Recoil Starter Cord**
- 15 Throttle Lever**

# Unboxing

## ⚠ Unboxing Safety

**⚠ WARNING!** Unboxing and assembling the machine should be done on a flat, stable surface with enough room. Disposal of the packaging should be done in accordance with the local regulations in force.

**⚠ WARNING!** Some of the packaging material may be harmful to children. Keep out of reach of children.

Carefully remove the product from the packaging and examine it for any sign of damage caused during shipping. Lay the contents out and check them. If any part is damaged or missing, you must not use the machine. Contact HYUNDAI Power Products immediately. You must keep the packaging material in case the machine needs to be returned or repaired.

Ensure that you have all the accessories and tools you need for assembly and operation including the suitable personal protective equipment.

## Box Contents

- User Manual
- Quick Start Guide
- 70L Grass Collector
- Assembly Tools
- HYM530SPR Lawnmower
- 2 x Rear Discharge Supports



# Assembly

## ⚠ Assembly Safety

**⚠ CAUTION** - This guide is meant to serve as a quick reference for operating your HYUNDAI machine. We always advise reading the manual in full before operation.

**⚠ CAUTION** - For OUTDOOR use ONLY. Petrol machines produce carbon monoxide – poisonous, colourless and odourless gas that can cause serious injury or death. Petrol is highly flammable, always handle with extreme care and in a well ventilated area.

**⚠ NOTE** - Images may vary depending on model.

**⚠ NOTE** - The machine may be supplied with some parts already assembled. Prior to assembly, check all items have been received. The mulching plug may already be installed for transport.

**⚠ NOTE** - This machine is shipped without fuel and oil and **MUST** be filled before use. Failure to do so may cause damage to the engine that will not be covered by warranty.

**We recommend that you fill out the information on page 66. If you need to contact an authorised dealer or customer service for information on servicing, you may need to provide this information.**

**There is also a service record so you can keep track of your machine service dates.**



# Assembly

## Unboxing & Assembly Video:

Go to [youtube.com](https://www.youtube.com) and type in Hyundai HYM530SPR assembly.

**YOU MUST read and understand the instruction manual first.**

## Step 1 : Assemble Handle Bars

You will need a 13mm spanner or an adjustable spanner for assembly.

- 1 Attach the lower handle to the deck of the mower and tighten the lower bolts securely.  
See image 1 & 2.
- 2 Align the height adjuster knob with the desired height location hole. There is a choice of 2 positions. The bottom hole is the tallest position and the top hole is the shortest position.  
See image 3 & 4.

Image 1



Image 2



Image 3



Image 4



# Assembly

- 3 Attach the upper handle to the lower handle and tighten the quick release handle bolts securely. **See image 5 & 6.**
- 4 Slowly pull the recoil start handle up to the cord loop on the handlebar. **See image 7 & 8.**

Image 5



Image 6



Image 7



Image 8



# Assembly

## Step 2 : Grass Collector Assembly

- 1 Slot the metal pole into the plastic parts around the grass collector.



# Assembly

## Step 3 : Attaching Grass Collector

- 1 Lift the rear discharge flap.
- 2 Lift the back end of the grass collector up high to get the front hooks over the bars.
- 3 Lower the rear discharge flap so it rests on the grass collector.



# Assembly

## Step 4 : Cable Attachment

**▲ NOTE - If stood behind the lawnmower:**

**OPC Cable :** Attaches to the lever in front of the main handlebar if traced, will attach to the engine.

**Drive Cable :** Attaches to the lever behind the main handlebar and if traced, will enter the deck of the lawnmower behind the engine.

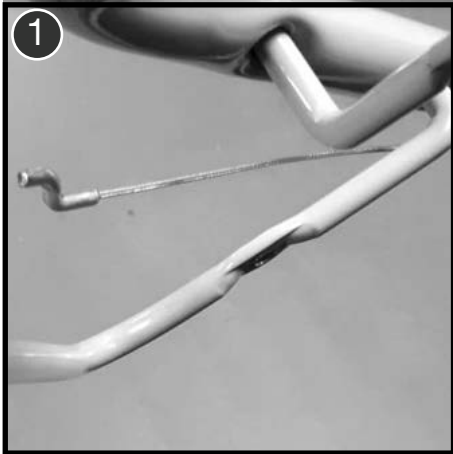

Follow the cable you want to attach and determine which lever it will attach to.

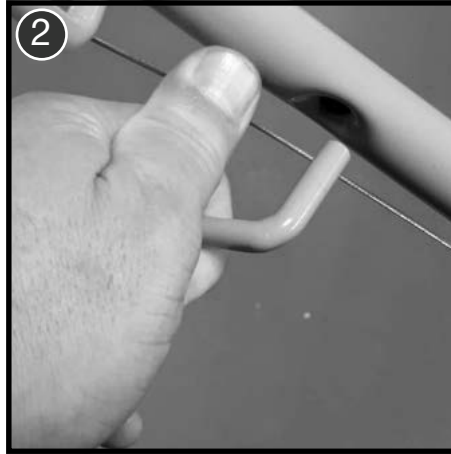

Gently prise the lever inwards from its locating hole in the main handlebar.

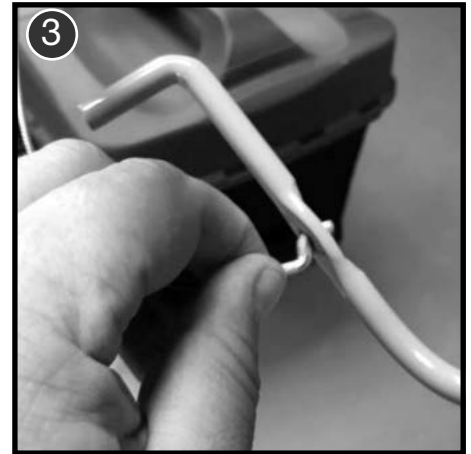

Insert the end of the cable in to the location hole on the lever.

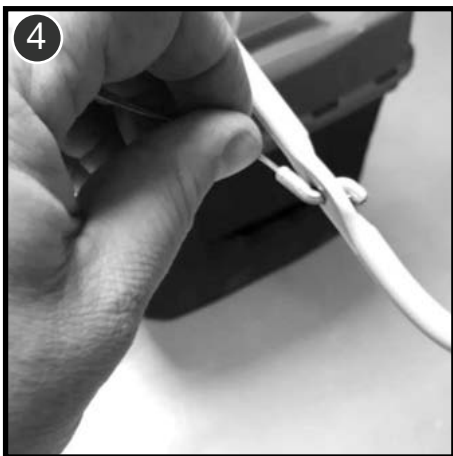

Position the cable until it lies flat in the lever.

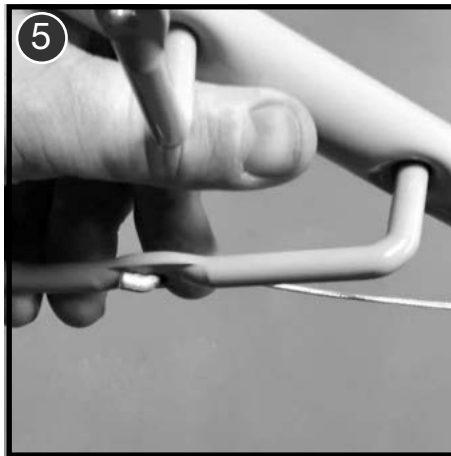

Refit the lever back into its location hole on the main handlebar.

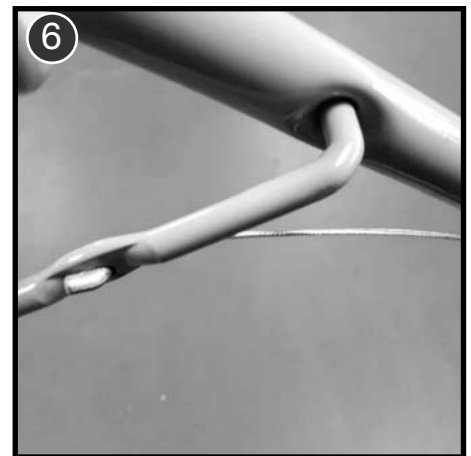

Check the cable lies flat and has not snagged on any other part of the lawnmower.

# Assembly

## Step 5 : Cable Clip

- 1 Use the plastic cable clip to attach the cables to the left-hand handlebar (if you are stood behind the machine).

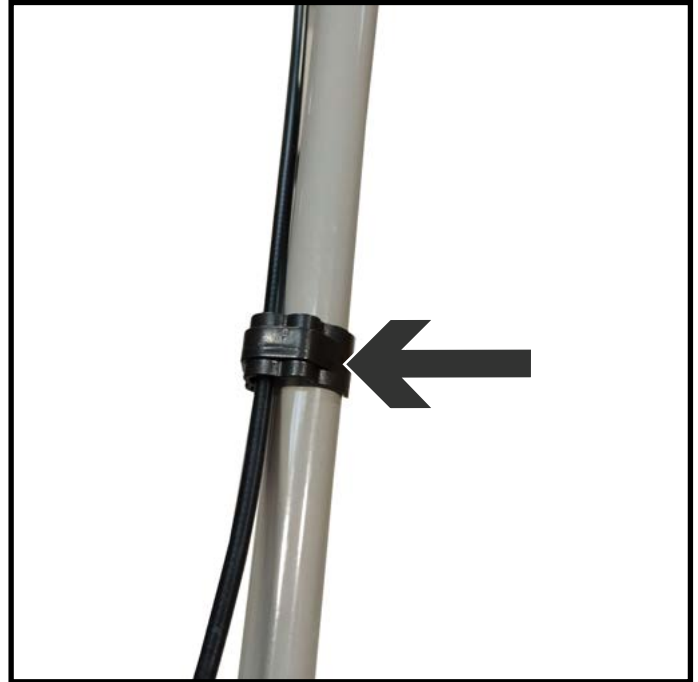

## Step 6 : Attach Central Panel

- 1 Use the screws and screw the central panel into place.



# Preparation

## Adding Oil

Oil Type : SAE 30 or 15w40 Engine Oil  
Oil Capacity : 600ml

**NOTE** - The machine is delivered without oil in the engine. All machines are tested and inspected so there may be some residual oil left in the machine so please fill with caution.

- 1 Remove the oil filler cap.
- 2 Fill with fresh SAE 30 or 15W40 engine oil to the upper mark on the dipstick. Stop occasionally to check the level. DO NOT overfill.
- 3 Once the correct amount of oil has been added, refit the dipstick securely.



## Checking Oil Level

- 1 Remove the oil filler cap and wipe the dipstick clean.
- 2 Remove the dipstick and check the oil level. It should be up to the upper mark on the dipstick.
- 3 If the oil level is too low, add SAE 30 or 15W40 engine oil to the upper mark on the dipstick. DO NOT overfill. The oil level should not be above the upper mark on the dipstick. If you do overfill, read the 'Changing / Draining Oil' section below for more information on draining oil.
- 4 Once the correct amount of oil has been added, refit the dipstick securely.



# Preparation

## Adding Fuel



Make sure you read the fuel safety before handling fuel.

Fuel Type : Fresh Straight Unleaded Petrol  
Fuel Capacity : 1L

**NOTE** - The machine is delivered without petrol. All machines are tested and inspected so there may be some residual petrol left in the machine so please fill with caution.

- 1 Remove the fuel tank cap.
- 2 Fill the fuel tank with fresh straight unleaded petrol. Allow a 25mm gap from the top of the tank, then refit the cap securely. DO NOT mix petrol with oil and clean up any spills immediately.

**NOTE** - DO NOT overfill. The fuel tank only needs to contain enough fuel to complete the days work. If you run out of fuel, refilling must only be done once the engine has cooled down. Fuel stored within the machine for 28 days or more can go stale and should be drained before further use.

**NOTE** - Make sure not to drip petrol onto the plastic parts to prevent damaging them and remove all traces of spilt petrol immediately. The warranty will not cover damage to plastic parts caused by petrol.

- 3 Refit the fuel filler cap securely and clean up any fuel spilt before starting the engine.



# Operation

## Cutting Height Adjustment

- 1 Make sure the engine is off.
- 2 Pull the adjustment lever outwards and select the required height.
- 3 The height is automatically adjusted for all wheels.



This is the lowest height setting.



This is the highest height setting.

# Operation

## Rear Discharge

- 1 Lift the rear discharge flap and remove the grass collector.
- 2 Install the 2 rear discharge supports and rest the rear discharge flap onto the supports.

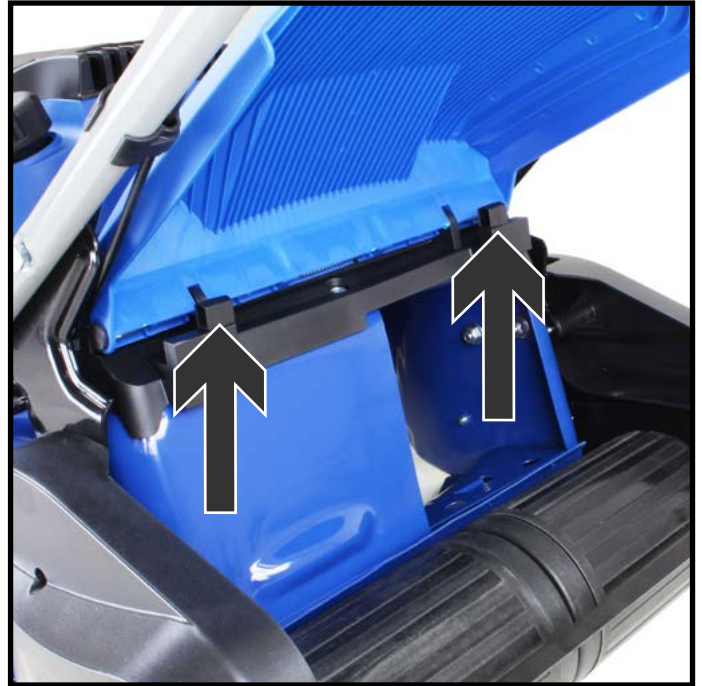

# Operation

## Creating Stripes

Stripes are created by light reflecting off the grass blades. Blades bent towards you appear dark and the grass blades facing away look lighter. Stripes look best on a healthy and bright lawn.

If your lawn is looking tired and dull, we recommend using a HYUNDAI Lawn Scarifier and Aerator. Scarification is the removal of moss, lawn clippings and dead grass blades from the stem of the grass to maintain a healthy growing environment. It is intensive airing of the lawn surface.

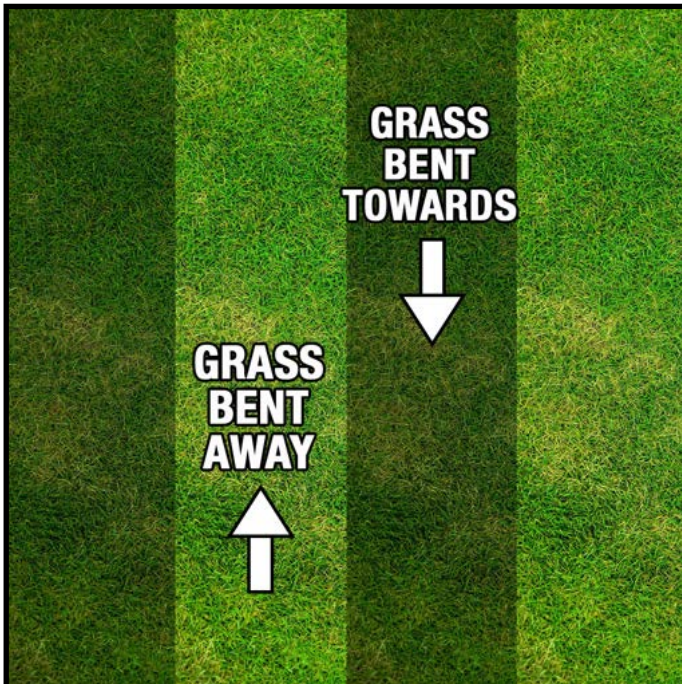

# Operation

## General Mowing Tips

- 1 Maintain a constant cutting height of 3-5cm. Do not shorten the grass to less than half its original height.
- 2 Under certain conditions, such as very tall grass, it may be necessary to raise the height of cut to reduce pushing effort, prevent overloading of the motor and leaving clumps of grass clippings.
- 3 It may also be necessary to reduce ground speed and/or push the lawnmower over the area a second time. For extremely heavy cutting, reduce the width of cut by overlapping the previously cut path and mow slowly.

## Recommended Mowing Schedule

### Spring (March, April & May)

Mow once a week on a high to medium height setting.

### Summer (June, July & August)

Mow twice a week under good growing conditions on a low setting. In dry conditions, mow once a week on a medium to high height setting.

### Autumn (September, October & November)

Mow once a week on a medium height setting.

### Winter (December, January & February)

Mow as required on a high height setting.



# Starting Procedure

**⚠ YOU MUST read and understand the full safety instruction manual before starting the machine.**

**⚠ CAUTION** - For OUTDOOR use ONLY. Petrol machines produce carbon monoxide – poisonous, colourless and odourless gas that can cause serious injury or death. Petrol is highly flammable, always handle with extreme care and in a well ventilated area.

**⚠ NOTE** - This machine is shipped without fuel and oil and MUST be filled before use. Failure to do so may cause damage to the engine that will not be covered by warranty.

## Before Each Use

**⚠ YOU MUST read and understand the full safety instruction manual before starting the machine.**

- 1 Always ensure that the machine is in a safe working condition. Inspect and check safety devices and guards and check all nuts, bolts and screws are secure.
- 2 Check the oil level and fill the fuel tank.
- 3 Make sure you know how to stop the machine and ensure you are familiar with emergency stop.
- 4 Start the machine following the instructions and stay clear of the machine's moving parts.
- 5 Check the OPC cable, if there is more than 10mm movement in the OPC lever before the cable begins to move, then the OPC cable will require adjustment.



# Starting Procedure

## Starting

- 1 Make sure the blade is free of long grass and the cutting height is set to the highest setting.
- 2 Place the choke lever to the 'START' position. This is located on the left of the central panel when stood behind the lawnmower. **See image 1.**
- 3 Pull the Operator Presence Control (OPC) lever back towards the main handlebar. **See image 2.**
- 4 Gently pull the recoil start handle until you feel resistance, then pull swiftly until the lawnmower starts. **See image 3.**
- 5 Once the engine starts, move the choke lever to the 'RUN' position.
- 6 Hold the drive lever against the main handlebar and the mower will propel forward. **See image 2.**
- 7 You can then adjust the throttle level to a suitable speed for the task. This lever is located on the right side of the central panel when stood behind the lawnmower. **See image 4.**

Image 1

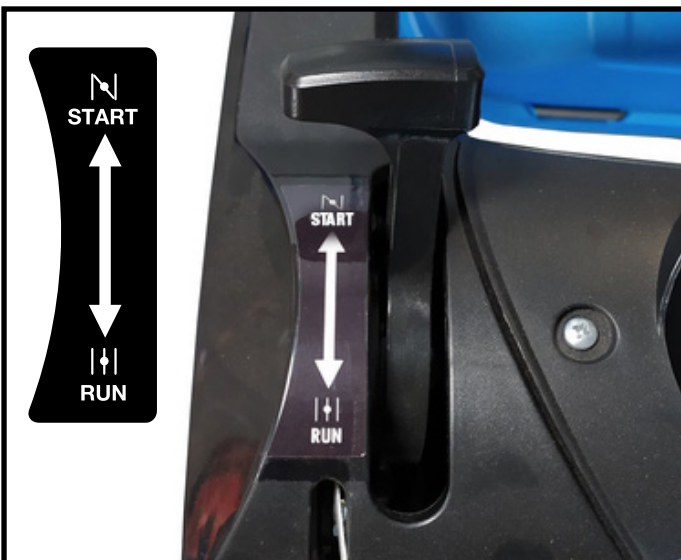

Image 2

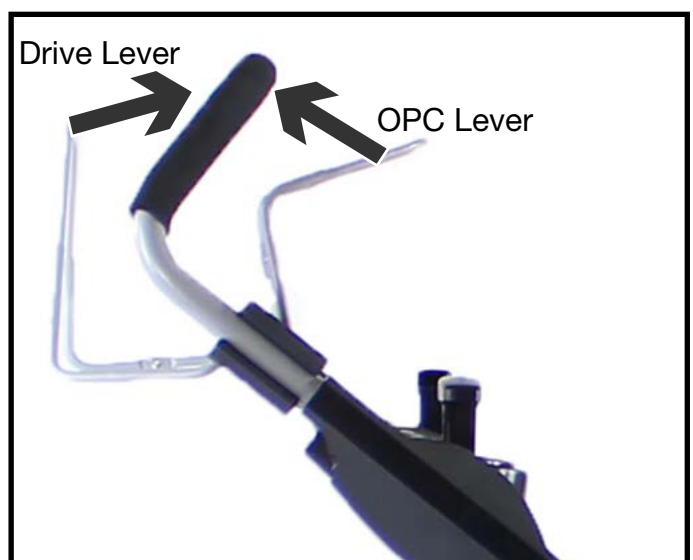

Image 3



Image 4



# Stopping Procedure

## Stopping

- 1 Before stopping the machine, you must allow the engine to idle for 30 seconds. You do not need to do this if you need to emergency stop the engine.
- 2 Release the Operator Presence Control (OPC) lever and the engine will stop.

**⚠ CAUTION** - The engine and exhaust will remain hot for a while after use. Ensure the engine and exhaust has cooled before carrying out any maintenance, refuelling or storage.

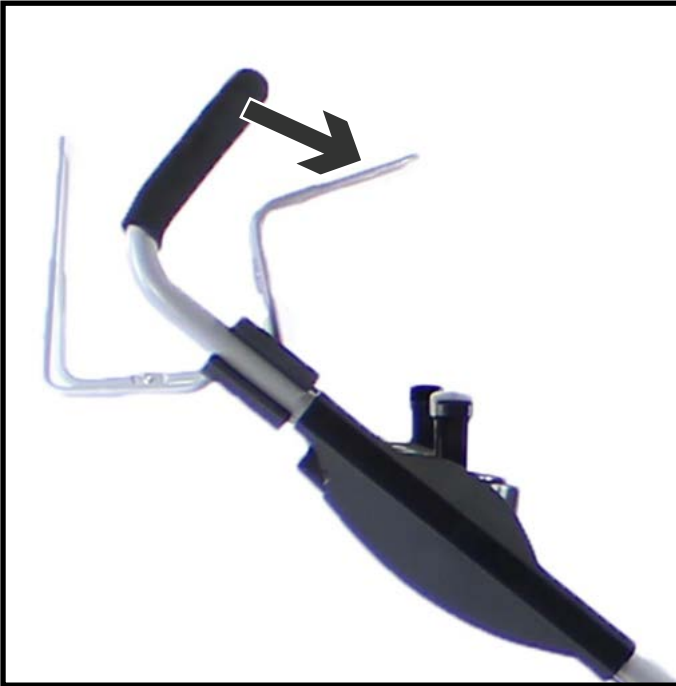



# Maintenance

## ▲ Maintenance Safety

 **IMPORTANT** - Routine and accurate maintenance is essential for maintaining original machine safety and performance levels.

 **WARNING** - Before cleaning or doing maintenance work, you need to stop the engine, disconnect the spark plug cable and read the relevant instructions. You need to wear proper clothing and protective gloves whenever your hands are at risk.

 If there are worn or damaged parts, never use the machine. Faulty or worn-out parts must be replaced and not repaired. You must only use original spare parts. The use of non-original and/or incorrectly fitted parts will jeopardize the safety of the machine. This may also cause accidents or personal injuries for which the manufacturer is under no circumstance liable or responsible.

 Any maintenance operations or adjustments not explained in this manual must be carried out by your Dealer or a specialised Service Centre with the necessary knowledge and equipment to ensure that the work is done correctly maintaining the machine's original safety level. Any operations performed in unauthorised centres or by unqualified persons will invalidate the Warranty and all obligations and responsibilities of the Manufacturer.

 Be very careful during adjustment of the machine to prevent entrapment of the fingers between moving parts and fixed parts of the machine.

## Checking Your Machine

When checking your machine, we recommend you:

- Check for worn or damaged parts.
- Make sure all nuts, screws and bolts are tight.
- Make sure all warning stickers are in place and not damaged.
- Check for oil / fuel leaks.
- Check the oil and fuel levels regularly.
- Frequently check the lawnmower and ensure that all grass deposits are removed from beneath the deck.
- Check the blade for damage.



# Maintenance

## Cleaning

 **CAUTION - DO NOT** use a hose pipe or pressure washer to clean the engine. Water can damage the engine or contaminate the fuel system.

 **NOTE** Engine must be switched off and spark plug lead disconnected.

## After Each Use

- You must remove grass and mud from the machine to prevent it from drying. This will cause problems the next time the machine is used.
- Wipe the machine down with a damp cloth.
- For larger build ups of debris, use a scraper or similar product.
- Dry the machine completely to prevent rust from forming.
- Make sure not to drip petrol onto the plastic parts to prevent damaging them and remove all traces of spilt petrol immediately. The warranty will not cover damage to plastic parts caused by petrol.

## Regularly

- Paint on internal chassis parts may start to flake over time due to abrasive action of cut grass. If this happens, you should touch-up with rust-proof paint to prevent rusting that could corrode the metal. You can use a light spray oil such as WD40 on exposed parts and cutting deck to help prevent rust.
- Avoid using solvents when cleaning plastic parts. Most plastics are susceptible to damage from various types of commercial solvents and may be damaged by their use.



# Maintenance

## Hose Attachment

- Connect a garden hose to the quick release hose connector on left side of the cutting deck, lower the cutting deck, start the engine and turn on water supply. Run engine for 2 minutes to clean underside of cutting deck.



## Transportation







Whenever the machine is to be handled, lifted, transported or tilted, you must:

- 1 Wear sturdy work gloves.
- 2 Hold the machine at the points that offer a safe grip, taking into account the weight and relative distribution of the same.
- 3 Use an appropriate number of people for the weight of the machine and the characteristics of the vehicle or the place where it must be placed or collected.
- 4 You must make sure that machine movements do not cause petrol leaks, damage or injuries.
- 5 During transport, make sure to fasten the machine securely with cables or straps.
- 6 The machine must be transported on a flat surface.

# Maintenance



## Storage

### Where To Store

-  Store in a cool, dry place away from sources of ignition and varying changes in temperature.
-  Store on a flat and level surface with all wheels on the ground.
-  DO NOT stack other items on top of the machine when in storage.
-  Store the machine in a safe place, out of the reach of children or anyone who is not familiar with operation.
-  To reduce fire hazards, keep the engine, silencer, and petrol storage area free of grass, leaves, or excessive grease. Do not leave containers full of cut grass inside storage areas.
-  DO NOT store the machine with fuel in the tank in an area where the fuel vapours could reach an open flame, a strong heat source or a spark.
-  DO NOT store a machine that has not been given time to fully cool down. Engine must be cooled down fully before storage.

### Short Term Storage

After use, please follow the below steps before storing your machine.

-  1 Allow the engine to fully cool down.
-  2 Clean the machine. See the 'Cleaning' section.
-  3 Store the machine following the guidelines above.



# Maintenance

## Long Term Storage

If storing the machine for a period of 30 days or more, you must follow proper storage and winterisation guidelines to avoid any possible issues with the machine. Incorrect storage can lead to possible fueling or engine issues that will not be covered by the warranty.

- 1 Allow the engine to fully cool down.
- 2 Drain all the fuel from the fuel tank and then run the machine until it has completely run out of fuel to clear the remaining fuel from the fuel lines and carburettor.
- 3 Drain the oil from the engine.
- 4 Follow the cleaning instructions in the 'Cleaning' section.
- 5 Follow the maintenance section and check, service or replace serviceable items if required. Visually inspect the machine and replace or repair any worn parts. Check the blade and sharpen or replace if necessary.
- 6 Lubricate all moving parts with light spray oil such as WD40.
- 7 Refill engine oil with new SAE 30 or 15w40 engine oil, fill to the upper mark on the dipstick.
- 8 Remove the spark plug and pour 1 teaspoon of fresh engine oil down the cylinder bore. Cover the spark plug hole with a lint free clean cloth, ensuring no dirt or debris falls into the cylinder chamber and gently pull the recoil starter handle to coat the cylinder bore with the fresh oil. Refit the spark plug.

## Preparation To Re-Use

- 1 Check oil level before using.
- 2 Check spark plug is inserted correctly.
- 3 Fill engine with fresh unleaded petrol that has not been stored for periods of more than 30 days.



# Maintenance

## The Blade

### **WARNING**

- Never touch a rotating blade.
- Check the blade in order to get a good cut. The blade should always be sharp and well balanced. At regular intervals, check the tightness of all nuts, bolts and screws.
- If the blade hits an obstacle, check for damage and if the machine vibrates badly, stop the lawnmower and take it to a service dealer.

- 1 You **MUST** wear gloves to protect your hands from being cut when working with the blade.
- 2 The blade is made of pressed steel, in order to obtain a good cut, sharpen the blade frequently, typically around every 25 hours of work.
- 3 Following blade sharpening, you must make sure that the blade is always well balanced.
- 4 To remove the blade, unscrew the centre bolt, check the blade carrier and all components. Replace if they are worn or damaged.
- 5 It is best if all interventions on the blade are done at a specialised centre that has the special tools and equipment.
- 6 Only original blades must be used on this machine. Given product evolution, the blades may be replaced in time with others having similar interchangeable and operating safety features.



# Maintenance

## Air Filter

**⚠ CAUTION** - A dirty air filter will restrict the air flow to the carburettor, which will reduce engine efficiency.

When using the machine in very dusty areas you must clean or replace the air filter more often. Never operate the machine without the air filter being fitted it can cause damage to the engine which is not covered by warranty.

- 1 To gain access to the air filter, press the 2 latch tabs on top of the air filter cover.
- 2 Remove filter, check for contamination and clean or replace as required.
- 3 Clean the filter by tapping it several times on a hard surface to remove dirt, or blow air through it using an air gun not exceeding 30psi.
- 4 Also clean the foam pre-filter. Wash in detergent and let dry.
- 5 Never use a brush to clean the filter it will only drive dirt into the fibres of the filter.

Wipe dirt from the air cleaner body by using a moist rag, be careful to prevent dirt or debris entering in to the carburettor.

- 6 Reinstall the filter and cover.

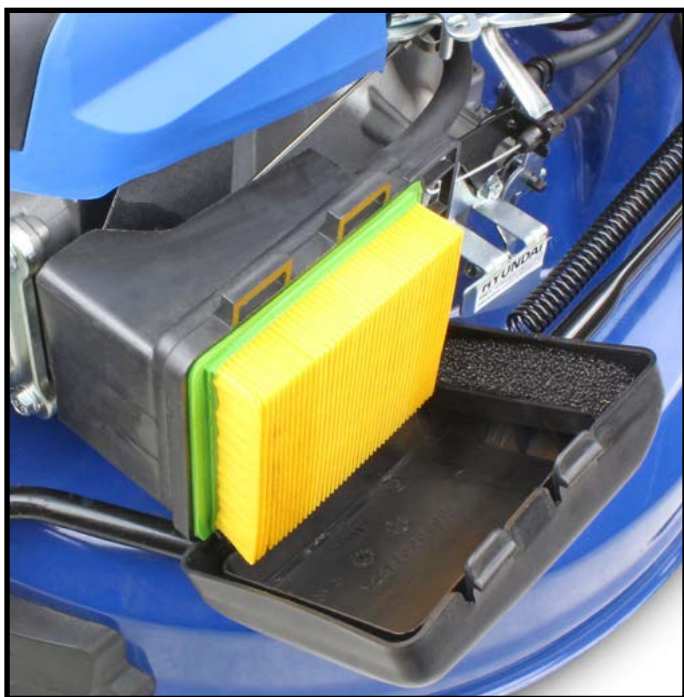

# Maintenance

## Spark Plug

For good performance, the spark plug must be properly gapped and free of deposits.

- 1 You **MUST** allow the engine to cool down before carrying out any maintenance.
- 2 Always use the correct spark plug.
- 3 To check the spark plug, remove the spark plug HT lead cap and remove the spark plug with the spark plug wrench.
- 4 Remove spark plug using the supplied spark plug wrench.
- 5 Clean the spark plug electrode with a soft wire brush, making sure there is no damage to the insulator or electrode.
- 6 The spark plug gap should be 0.70mm to 0.80mm. Check the gap by using a feeler gauge. Adjust as necessary by carefully bending the side electrode to achieve the correct gap.

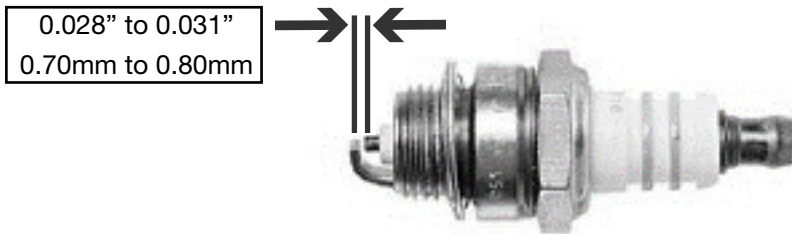

- 7 Refit the cleaned and adjusted spark plug by hand to avoid cross-threading.
- 8 After spark plug seats then tighten as necessary with a spark plug wrench but avoid over-tightening.
- 9 Re-attach the spark plug cap.

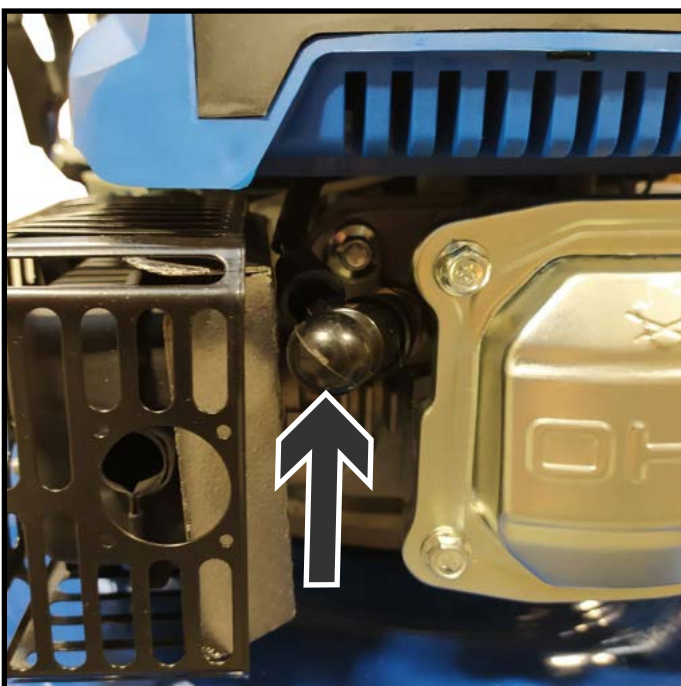

# Maintenance

## Changing / Draining Oil

**To reduce fire hazards, check there is no oil and/or fuel leaks on a regular basis.**

It is highly recommended to change the engine oil every 100 hours or 12 months. This will ensure the machine will function properly over time.

There are different ways you can empty the oil:

- The oil can be discharged at a specialised servicing centre.
- You can use an oil syringe to suction the oil out through the filler spout, bearing in mind you may need to repeat the operation several times in order to completely empty the tank.
- Gently tilt the machine with the air filter facing upwards and allow the excess oil to drain from the dipstick port, into a suitable container.

Remember to top-up with oil before using the machine again.

## Fuel & Carburetor

**⚠ CAUTION - ALL FUELS ARE FLAMMABLE.** Always fuel and defuel in a well-ventilated area outside of buildings. Always wear correct PPE and wipe up and spills immediately.

**The use of old or stale petrol will impair the starting and running of the machine.**

- 1 Make sure that the machine has fresh unleaded petrol and always remove the fuel before storing for long periods of time.
- 2 To drain the carburetor float bowl, undo the drain bolt making sure that the washer is not lost. If stored for more than 2 weeks and engine will not start, drain the old fuel from the carburetor float bowl to allow fresh fuel to fill the carburetor.
- 3 Use a suitable container to catch the fuel. Take care not to spill fuel and make sure that all spilt fuel is cleared away safely. Float bowl contains approx 30ml of fuel. It is possible to empty the entire fuel system by this method, as the fuel tank feeds the carburetor.

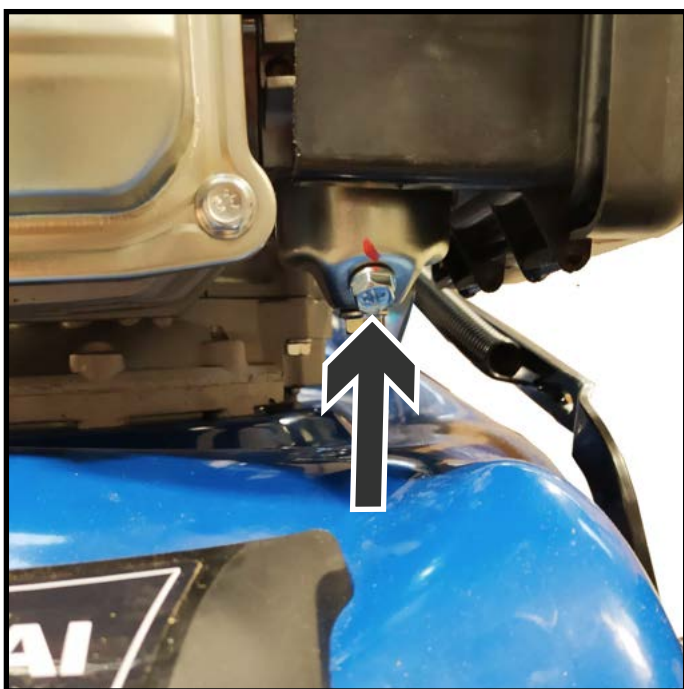

# Maintenance

## OPC Cable Adjustment

**▲ NOTE** - If there is more than 10mm movement in the OPC lever before the cable begins to move, then the OPC cable will require adjustment. It is necessary as part of routine maintenance to adjust the OPC cable tension to ensure the lawnmower will start correctly.

- 1 Follow the OPC cable to the adjuster located on the side of the engine.
- 2 Undo the lock nut and wind it forwards.
- 3 Move the adjustment nut towards the lock nut and continually check the cable tension at the lever.
- 4 Once the movement has been removed, hold the adjustment nut in place and tighten the lock nut back towards the adjustment lever to lock the cable in place. Check the cable adjustment has worked by starting the mower. If the mower still fails to start, re-adjust until the lawn mower starts. Also check that when the OPC lever is released, that the blade stops promptly.

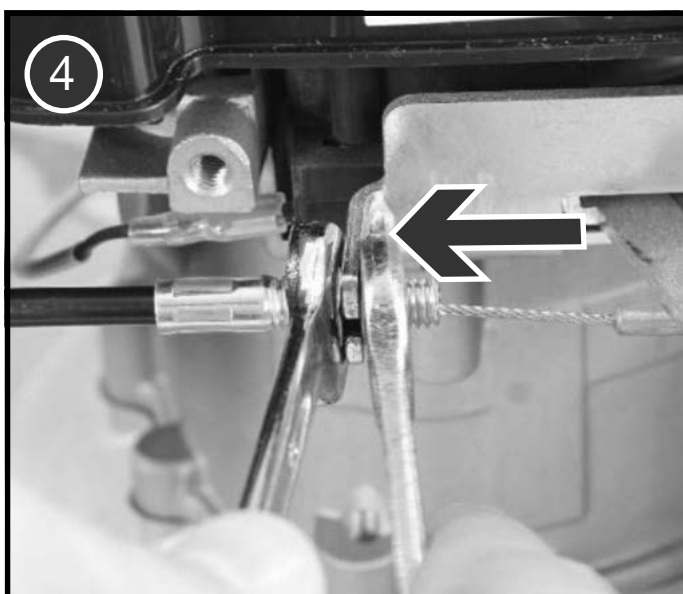
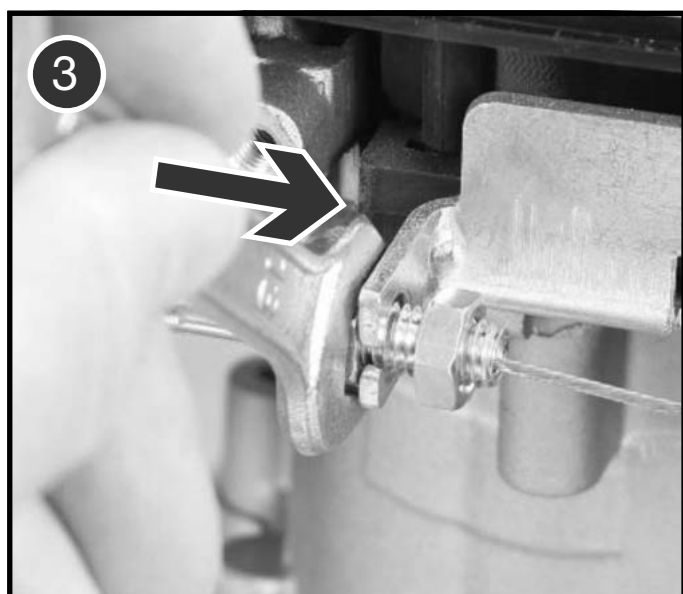
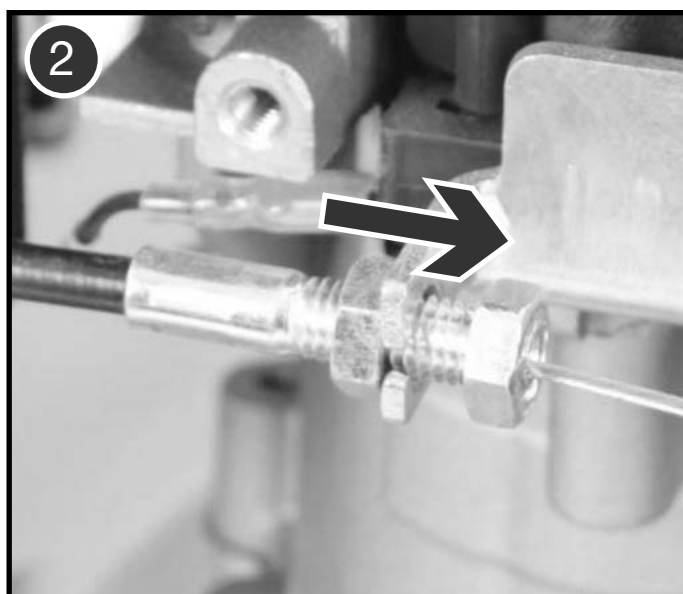
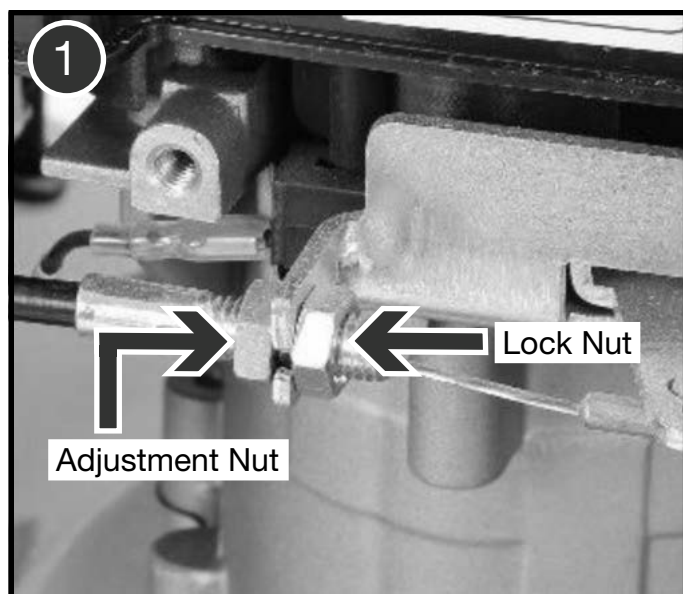

# Maintenance

## Drive Cable Adjustment

**▲ NOTE** - If there is more than 10mm movement in the drive lever before the cable begins to move, then the drive cable will require adjustment. It is necessary as part of routine maintenance to adjust the drive cable tension to ensure the lawnmower will self-propel correctly.

- 1 Follow the drive cable down towards the lawnmower until you reach the drive cable adjuster.
- 2 Undo the lock nut and wind it forwards.
- 3 Wind the adjuster nut towards the main handlebar. As you adjust, keep checking the tension on the drive cable until the desired tension is reached.
- 4 Tighten the lock nut finger tight, back towards the adjuster nut and check for drive on the lawn mower. If adjusted correctly the lawnmower will self-propel. Once drive is restored, tighten the lock nut securely.

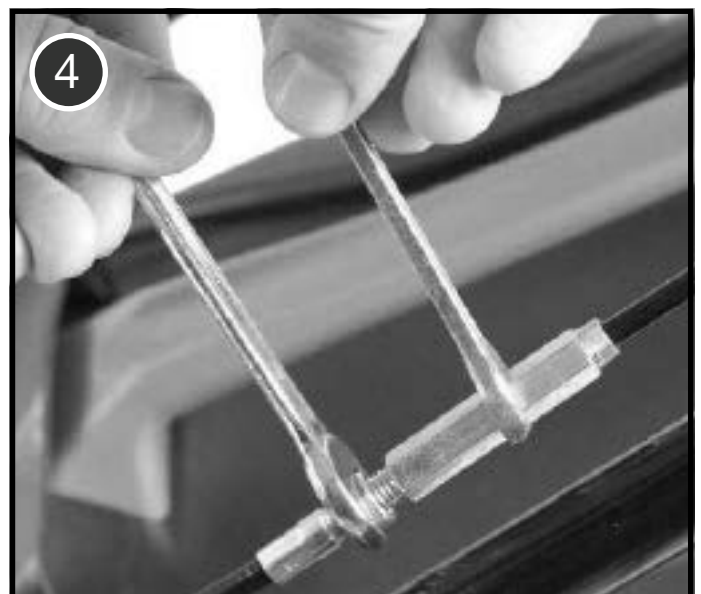
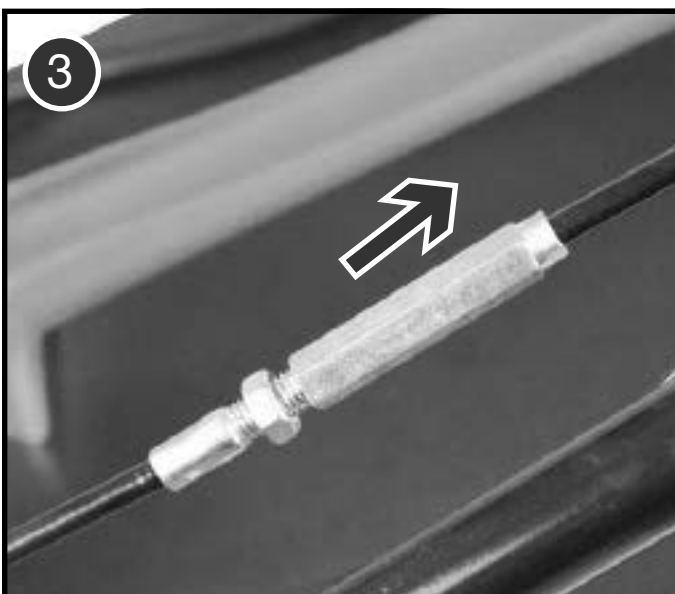
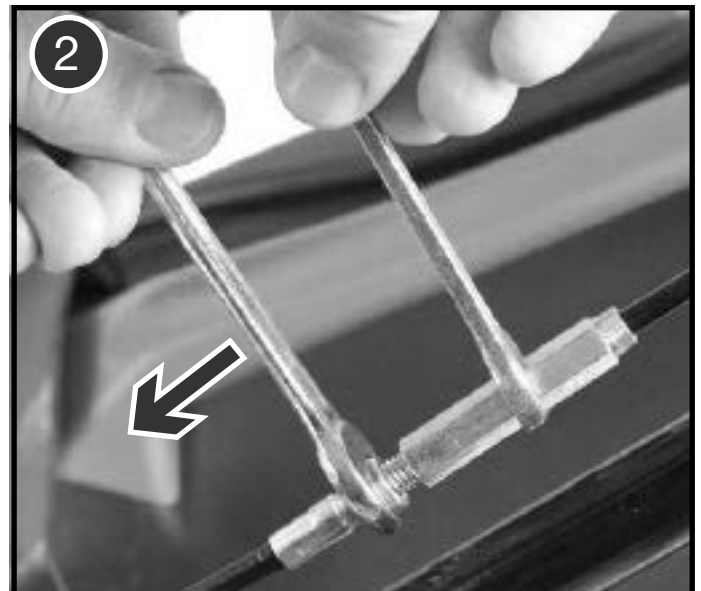
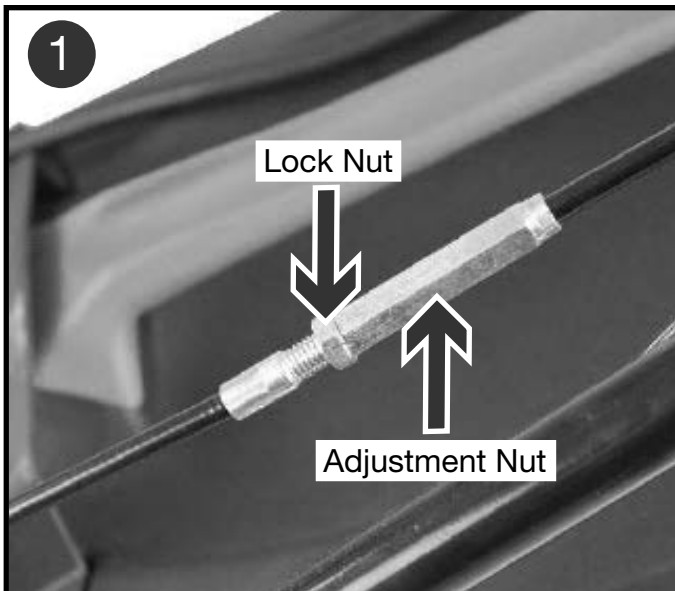

# Troubleshooting

Problem	Possible Cause	Possible Solution
Engine does not start	<ol style="list-style-type: none"> <li>① OPC cable not adjusted correctly.</li> <li>② Fuel tank is empty.</li> <li>③ Stale petrol.</li> <li>④ Air filter element is dirty.</li> <li>⑤ Spark plug is loose.</li> <li>⑥ Spark plug cap loose or disconnected.</li> <li>⑦ Engine flooded.</li> </ol>	<ol style="list-style-type: none"> <li>① Adjust OPC cable.</li> <li>② Fill fuel tank.</li> <li>③ Drain carburetor float bowl.</li> <li>④ Clean or replace air filter.</li> <li>⑤ Tighten spark plug.</li> <li>⑥ Correctly fit the spark plug cap.</li> <li>⑦ Wait several minutes before starting.</li> </ol>
Spark plug faulty	<ol style="list-style-type: none"> <li>① Spark plug cap is incorrect.</li> <li>② Carburetor is flooded with fuel.</li> <li>③ Faulty ignition module.</li> </ol>	<ol style="list-style-type: none"> <li>① Set plug gap to 0.7 - 0.8mm or replace spark plug.</li> <li>② Remove the air filter and pull starter rope until carburetor clears.</li> <li>③ Contact the service dealer.</li> </ol>
Engine difficult to start or loses power	<ol style="list-style-type: none"> <li>① Dirt, water or stale fuel in tank.</li> <li>② Vent hole in fuel tank is clogged.</li> <li>③ Air filter element is dirty.</li> </ol>	<ol style="list-style-type: none"> <li>① Drain fuel and clean tank. Fill with clean, fresh fuel.</li> <li>② Clean or replace fuel tank cap.</li> <li>③ Clean or replace air filter element.</li> </ol>
Engine operates erratically	<ol style="list-style-type: none"> <li>① Spark plug is defective.</li> <li>② Spark plug gap is incorrect.</li> <li>③ Air filter element is dirty.</li> </ol>	<ol style="list-style-type: none"> <li>① Fit new, correctly gapped spark plug.</li> <li>② Set plug gap to 0.7 - 0.8mm.</li> <li>③ Clean or replace air filter element.</li> </ol>
Engine idles poorly	<ol style="list-style-type: none"> <li>① Air filter element is dirty.</li> <li>② Air slots in engine are blocked.</li> <li>③ Cooling fins and air passages under engine housing are blocked.</li> </ol>	<ol style="list-style-type: none"> <li>① Clean or replace air filter element.</li> <li>② Remove debris from slots.</li> <li>③ Remove debris from cooling fins and passages.</li> </ol>
Engine skips at high speed	<ol style="list-style-type: none"> <li>① Spark plug electrode gap is incorrect.</li> </ol>	<ol style="list-style-type: none"> <li>① Set plug gap to 0.7 - 0.8mm.</li> </ol>
Engine overheating	<ol style="list-style-type: none"> <li>① Cooling airflow is restricted.</li> <li>② Incorrect spark plug.</li> </ol>	<ol style="list-style-type: none"> <li>① Remove any debris from slots in shroud, blower housing and air passages.</li> <li>② Fit new spark plug.</li> </ol>
Mower vibrates abnormally*	<ol style="list-style-type: none"> <li>① Cutting assembly is loose.</li> <li>② Blade / cutting assembly is unbalanced.</li> </ol>	<ol style="list-style-type: none"> <li>① Tighten blade.</li> <li>② Take to a service dealer.</li> </ol>

**\*DO NOT use the machine until vibration issue has been fixed.**

⚠ Where necessary, all corrective actions should be carried out by a suitably qualified person.



# Technical Data

## Specifications

<b>Model</b>	<b>HYM530SPR</b>
Engine Type	HYUNDAI IC200V, 4-Stroke OHV Single Cylinder
Engine Size	196cc
Rated Power	4.2kW
Max. Engine Speed	2800rpm
Fuel Tank Capacity & Fuel Type	1L Straight Unleaded Petrol
Oil Capacity & Oil Type	600ml SAE30 or 15W40
Start Method	Recoil Start
Height Adjustment	5 Positions
Cutting Height	25-75mm
Cutting Width	53cm / 530mm
Grass Collector Capacity	70L
Drive	Self-Propelled
Functions	Rear Discharge, Lawn Striping & Collect
Handle Type	Soft Grip, Foldable
Measured Sound Level	97dB(A)
Guaranteed Sound Level	98dB(A)
Vibration Value	11.437m/s <sup>2</sup> K=1.5 m/s <sup>2</sup>
Net Weight	40.5kg



# Spare Parts

## Ordering Spare Parts

**!** Only use original spare parts: The use of non-original and/or incorrectly fitted parts will jeopardise the safety of the machine, may cause accidents or injuries for which the manufacturer is under no circumstance liable or responsible.

- 1 Find the part you are looking for in the drawings.
- 2 Information about the parts can be found in the tables below or visit [power-spare.co.uk](http://power-spare.co.uk)
- 3 Use this information to order the part.
- 4 Contact us if you need help finding the correct part.

### Drawing A

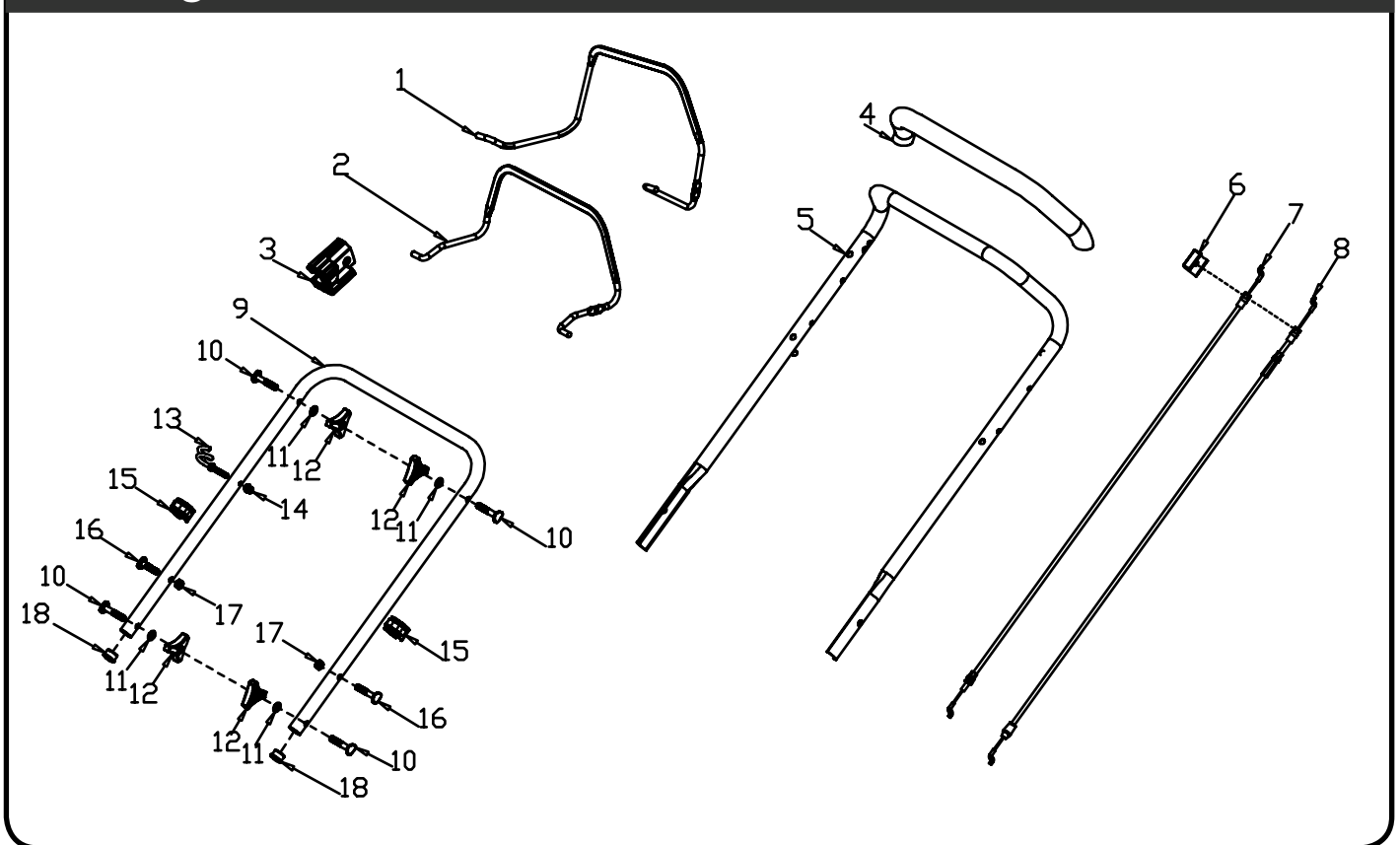

# Spare Parts

## Drawing B

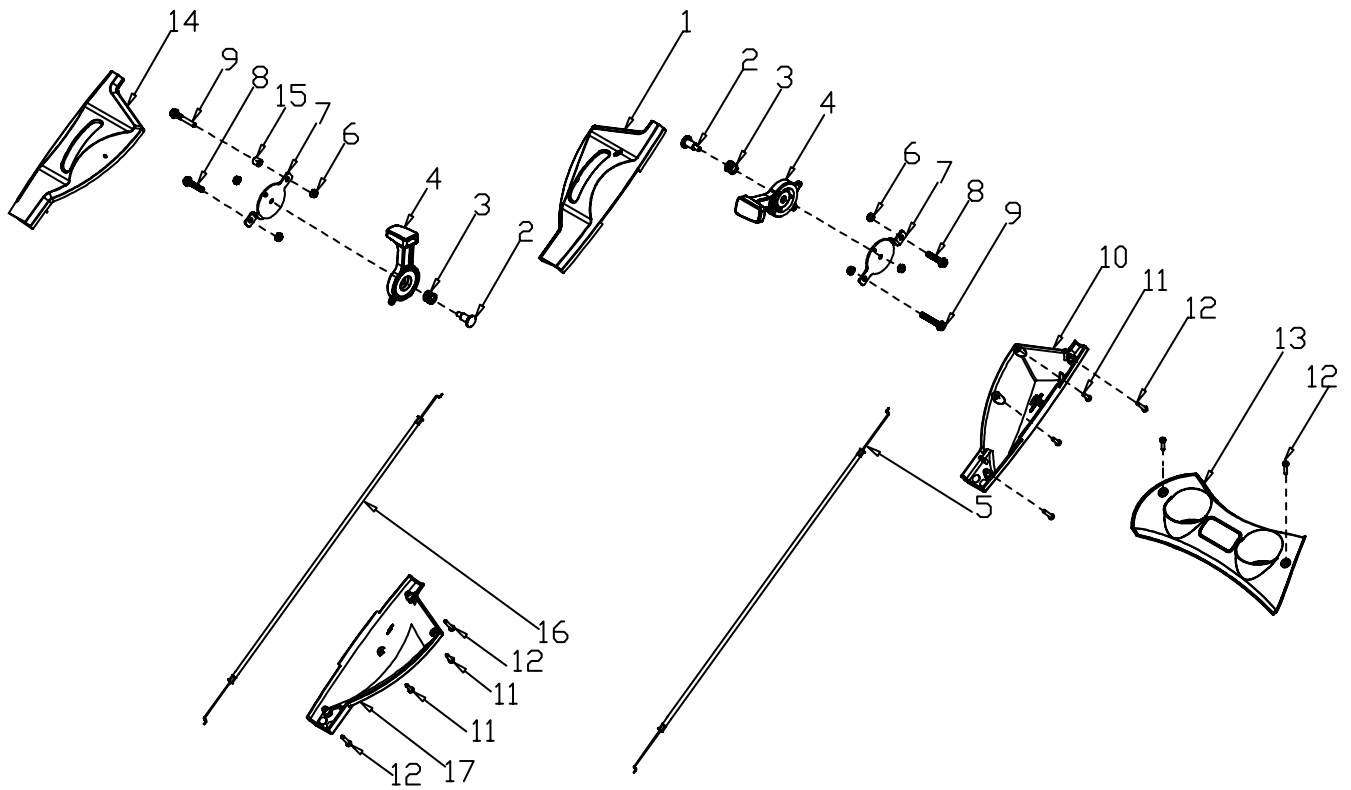

## Drawing C

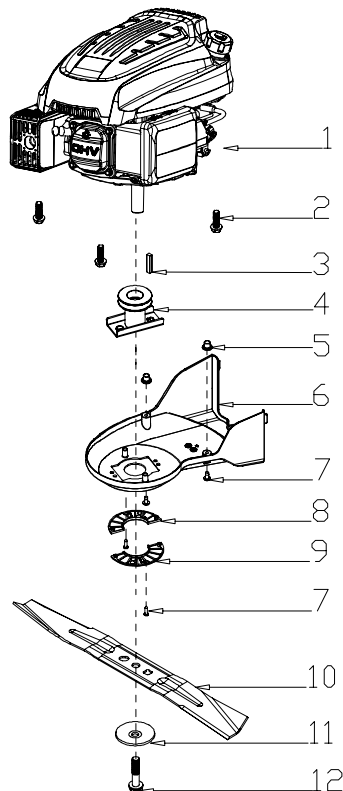

# Spare Parts

## Drawing D

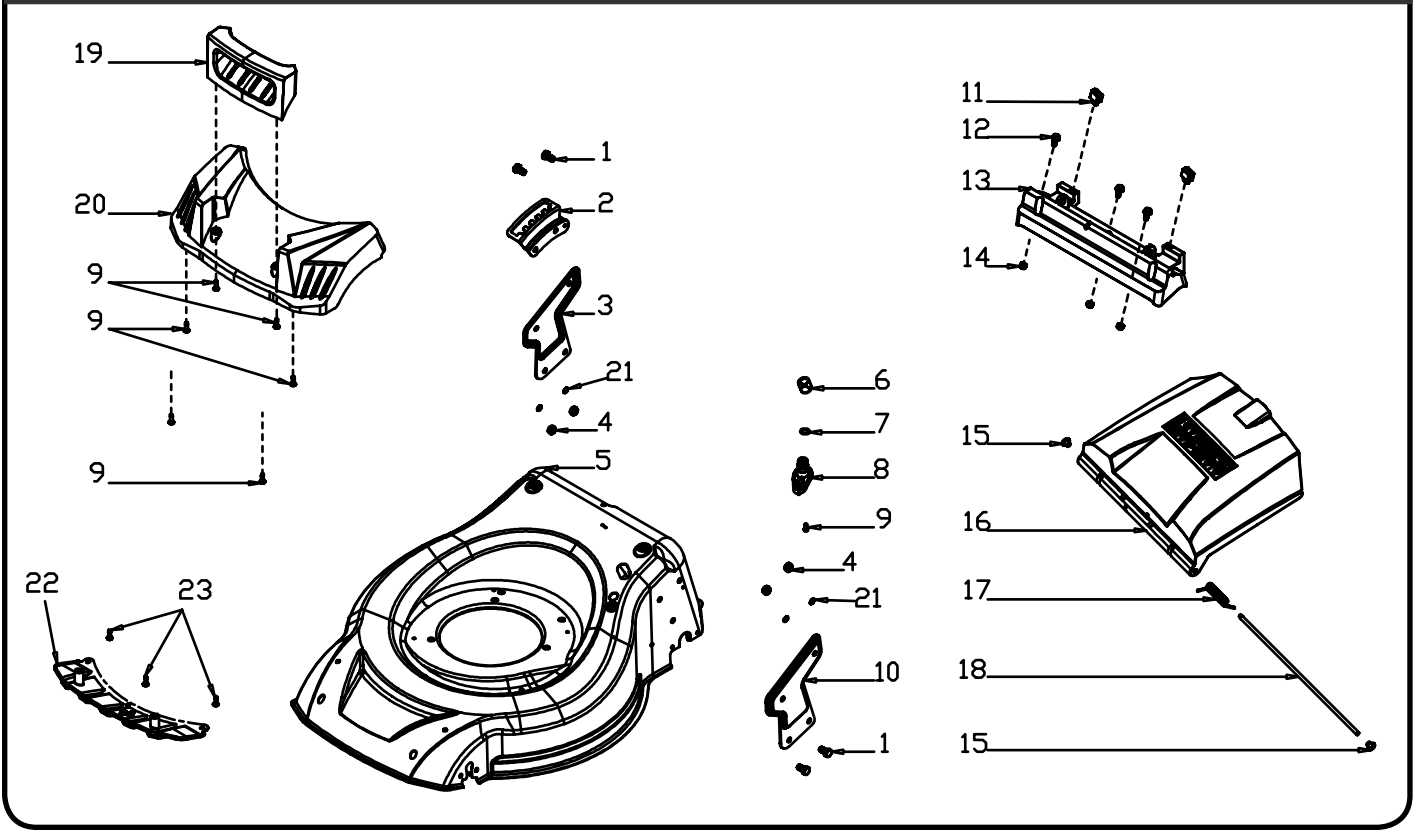



# Spare Parts

## Drawing A

Drawing Number	Spare Part Name	Part Number
HYM530SPR-A1	Clutch Lever	1290032
HYM530SPR-A2	Brake Lever	1001001
HYM530SPR-A3	Limiting Stopper	1290002
HYM530SPR-A4	Foam Pipe	1290003
HYM530SPR-A5	Upper Handle	1149005
HYM530SPR-A6	Cable Fixing Clamp	1290034
HYM530SPR-A7	Brake Cable	1147007
HYM530SPR-A8	Clutch Cable	1290035
HYM530SPR-A9	Lower Handle	1149009
HYM530SPR-A10	Bolt	1290006
HYM530SPR-A11	Flat Washer	1290007
HYM530SPR-A12	Knob	1290008
HYM530SPR-A13	Rope Guide	1001010
HYM530SPR-A14	Nut	1290033
HYM530SPR-A15	Cable Support	1290009
HYM530SPR-A16	Bolt	1001013
HYM530SPR-A17	Nut	1290011
HYM530SPR-A18	Handle Plug	1288008

## Drawing B

Drawing Number	Spare Part Name	Part Number
HYM530SPR-B1	Upper Cover	1149019
HYM530SPR-B2	Screw	1149020
HYM530SPR-B3	Spring	1149021
HYM530SPR-B4	Plastic Grip	1149022
HYM530SPR-B5	Cable	1149023
HYM530SPR-B6	Nut	1290064
HYM530SPR-B7	Fixed Plate	1149025
HYM530SPR-B8	Bolt	1149026
HYM530SPR-B9	Bolt	1149027
HYM530SPR-B10	Lower Cover	1149028
HYM530SPR-B11	Screw	1290070
HYM530SPR-B12	Screw	1149030
HYM530SPR-B13	Handle Panel	1149031
HYM530SPR-B14	Upper Cover	1149032
HYM530SPR-B15	Bush	1149033
HYM530SPR-B16	Speed Adjusting Cable	1148039
HYM530SPR-B17	Lower Cover	1149044



# Spare Parts

## Drawing C

Drawing Number	Spare Part Name	Part Number
HYM530SPR-C1	Engine	1147036
HYM530SPR-C2	Screw	1149046
HYM530SPR-C3	Blade Adapter	1149047
HYM530SPR-C4	Screw Cap	1149048
HYM530SPR-C5	Blade Adapter	1290042
HYM530SPR-C6	Belt Cover	1149050
HYM530SPR-C7	Screw	1290044
HYM530SPR-C8	Belt Cover Plate 1	1149052
HYM530SPR-C9	Belt Cover Plate 2	1149053
HYM530SPR-C10	Screw	1147045
HYM530SPR-C11	21" Blade	1148051
HYM530SPR-C12	Blade Washer	1149055
HYM530SPR-C13	Blade Bolt	1149056
HYM530SPR-C14	Engine Cover	1149058
HYM530SPR-C15	Screw	1149057
HYM530SPR-C16	Fuel Filter Pipe	1149059
HYM530SPR-C17	Tube Clip	1149060

## Drawing D

Drawing Number	Spare Part Name	Part Number
HYM530SPR-D1	Bolt	1148058
HYM530SPR-D2	Height Adjustment Plate	1148059
HYM530SPR-D3	Right Bracket	1149063
HYM530SPR-D4	Nut	1290094
HYM530SPR-D5	Deck	1148062
HYM530SPR-D6	Cable Sleeve	1149067
HYM530SPR-D7	Seal Ring	1149068
HYM530SPR-D8	Washing Linker	1149069
HYM530SPR-D9	Screw	1290072
HYM530SPR-D10	Left Bracket	1149071
HYM530SPR-D11	Rear Cover Support	1148068
HYM530SPR-D12	Bolt	1290062
HYM530SPR-D13	Rear Cover Pedestal	1147065
HYM530SPR-D14	Nut	1147066
HYM530SPR-D15	Plug	1290065
HYM530SPR-D16	Rear Cover	1290066
HYM530SPR-D17	Rear Cover Spring	1290067
HYM530SPR-D18	Rear Cover Shaft	1290068



# Spare Parts

## Drawing D (Continued)

Drawing Number	Spare Part Name	Part Number
HYM530SPR-D19	Lift Handle	1148076
HYM530SPR-D20	Front Plastic Cover	1148077
HYM530SPR-D21	Washer R	1148078
HYM530SPR-D22	Washer L	1148079
HYM530SPR-D23	Charger	1001063
HYM530SPR-D24	Comb Board	1148081
HYM530SPR-D25	Screw	1147077

## Drawing E

Drawing Number	Spare Part Name	Part Number
HYM530SPR-E1	Roller Shaft	1148088
HYM530SPR-E2	Roller Bush	1148089
HYM530SPR-E3	Roller Cover	1148090
HYM530SPR-E4	Roller	1148091
HYM530SPR-E5	Bearing	1148092
HYM530SPR-E6	Bearing Support	1148093
HYM530SPR-E7	Oil Seal	1148094
HYM530SPR-E8-1	Height Adjustment Handle	1148095
HYM530SPR-E8-2	Bearing	1148096
HYM530SPR-E9	Height Adjustment Handle	1290086
HYM530SPR-E10	Bearing	1148098
HYM530SPR-E10-1	Ring	1148099
HYM530SPR-E11	Gasket	1148100
HYM530SPR-E12	Bolt	1148101
HYM530SPR-E13	Cap	1148102
HYM530SPR-E14	Cover	1148103
HYM530SPR-E15	Nut	1290012
HYM530SPR-E16	Cover	1148105
HYM530SPR-E17	Bolt	1148106
HYM530SPR-E18	Screw	1147097
HYM530SPR-E19	Chain Wheel	1148108
HYM530SPR-E20	Chain	1148109
HYM530SPR-E21	Inner Cover	1148110
HYM530SPR-E22	Outer Cover	1148111
HYM530SPR-E23	Belt Li737	1148112
HYM530SPR-E24	Gear Box	1148113
HYM530SPR-E25	Spring for Gear Box	1148114
HYM530SPR-E26	Ball Bearing	1148115



# Spare Parts

## Drawing E (Continued)

Drawing Number	Spare Part Name	Part Number
HYM530SPR-E27	Lock Ring	1290105
HYM530SPR-E28	Chain Wheel	1148117
HYM530SPR-E29	Front Wheel Shaft	1148118
HYM530SPR-E30	Shaft Sleeve	1290118
HYM530SPR-E31	Nut	1147110
HYM530SPR-E32	Shaft Bush	1148121
HYM530SPR-E33	Bolt	1290090
HYM530SPR-E34	Spring Washer	1290089
HYM530SPR-E35	Bearing	1290113
HYM530SPR-E36	7" Wheel	1290114
HYM530SPR-E37	Nut	1147116
HYM530SPR-E38	7" Outer Wheel Cover	1290115
HYM530SPR-E39	Height Adjustment Connecting Rod	1148128
HYM530SPR-E40	Split Pin	1290096
HYM530SPR-E41	Spring	1148130

## Drawing F

Drawing Number	Spare Part Name	Part Number
HYM530SPR-F1	Metal Bracket	1148131
HYM530SPR-F2	Flat Washer	1290121
HYM530SPR-F3	Screw	1147123
HYM530SPR-F4	Fixed Plate	1290123
HYM530SPR-F5	Plastic Cover	1290124
HYM530SPR-F6	Cover Plate	1290125
HYM530SPR-F7	Handle Cover	1290126
HYM530SPR-F8	Indicated Board	1290127
HYM530SPR-F9	Fabric Bag	1148139







# Recycling And Disposal

## Recycling And Disposal



We do not offer a takeback scheme for the recovery of Waste Electrical Electronic Equipment (WEEE) & Batteries. Instead the responsibility to dispose of WEEE and/or Batteries is passed onto you by us.

So when it becomes necessary to dispose of your machine you must take it to your local Civic Amenity Site. For further information please contact your local Authority for disposal advice.

You **MUST** make sure that all unused oil and fuel is disposed of correctly either beforehand or at your local Civic Amenity Site.

- Under NO circumstances must any fuel or oil be put down any drains.
- Certain products contain WEEE waste which should not be disposed of in your domestic waste.
- You **MUST** recycle WEEE in accordance with your local authority or recycling centre.
- Certain products contain batteries which should not be disposed of in your domestic waste.
- You **MUST** recycle batteries in accordance with your local authority or recycling centre.
- Unwanted packaging and materials should be stored and taken to a recycling centre so it can be disposed of in a manner which is compatible with the environment.

We are a Member of the VALPAK National Compliance Scheme and our registration number is **RM08660**. For further information about disposal please contact your Local Authority.

You can also get more advice and guidance about recycling at the following website  
<http://www.recycle-more.co.uk>

Should you pass this product on to another user either sold or loaned, you **MUST** pass on this user manual. This will make sure that all other users can use and maintain this machine safely.

## Environmental Protection

1. Environmental protection should be a priority of considerable importance when using the machine, for the benefit of both social coexistence and the environment in which we live. Try not to cause any disturbance to the surrounding area.
2. You must comply with local regulations and provisions for the disposal of packaging, oils, petrol, filters, damaged parts or any elements which have a strong impact on the environment. This waste must not be disposed of as normal waste. It needs to be separated and taken to specified waste disposal centres where the material will be recycled.
3. You must comply with local regulations for the disposal of waste materials after mowing.
4. When disposing, do not pollute the environment with the machine, but hand it over to a disposal centre, in accordance with the local laws in force.



# Declaration Of Conformity

## EC Declaration of Conformity

We hereby declare that the machine detailed in this declaration complies to all the relevant provisions of the following EC directives.

- 2006/42/EC The Machinery Directive
- 2014/30/EU Annex II Electromagnetic Compatibility Directive
- 2016/1628/EC The Emission of Gaseous and Particulate Pollutants from internal Combustion engines
- 2000/14/EC Noise Emissions in the Environment by Equipment for use Outdoors.

And is in conformity with the applicable requirements of the following documents:

- EN ISO 3744:1995
- EN ISO 11094:1991
- EN ISO 5395-1:2013
- EN ISO 5395-2: 2013
- EN ISO 14982:2009

Delclaration for 2000/14/EC Noise Emissions in the Environment by Equipment for use Outdoors.

Notified Body for EC Directive 2000/14/EC TÜV Rheinland (Shanghai) Co., Ltd.

Model	Type	Cutting Width	Measured Sound Power	Guaranteed Sound Power	Engine speed (rpm)
HYM430SPR	Petrol lawn mower with rear roller	430mm	94dB(A)	96dB(A)	2800
HYM430SPER		430mm	94db(A)	96dB(A)	2800
HYM480SPR		480mm	94dB(A)	96dB(A)	2800
HYM480SPER		480mm	94dB(A)	96dB(A)	2800
HYM530SPR		525mm	97dB(A)	98dB(A)	2800
HYM530SPER		525mm	97dB(A)	98dB(A)	2800

### Product Details

Brand: Hyundai

Model: HYM430SPR, HYM430SPER, HYM480SPR, HYM480SPER, HYM530SPR, HYM530SPER  
Description: Petrol lawnmower with rear roller.

### Name and address of technical documentation holder and EU distributor:

Genpower Ltd, Isaac Way, Pembroke Dock, Pembrokeshire, SA72 4RW, UK.

Signed by:



Roland Llewellyn, Managing Director

Date: 10/12/2019



# Useful Information

## Check Out Our YouTube Channel

Our videos on YouTube include:

- Unboxing
- Assembly of your machine
- How to service your machine
- Products in use
- 'How To' videos
- Product features

Go to [www.hyundaisupport.co.uk](http://www.hyundaisupport.co.uk) or search 'Hyundai Power Products' in YouTube.

## Warranty

Proof of purchase will be required before you make a warranty claim.

Full warranty terms and conditions can be found on the HYUNDAI POWER PRODUCTS website: [www.hyundaipowerproducts.co.uk](http://www.hyundaipowerproducts.co.uk)

## Manual Updates

Our manuals are constantly being reviewed and updated. Should you find an error, omission or something unclear, please contact us for assistance.

We reserve the right to make any modifications without prior notice whenever necessary.

Our latest manuals are also placed online.

All our manuals can be downloaded at: [www.hyundaipowerproducts.co.uk](http://www.hyundaipowerproducts.co.uk)

## Returning Your Product

If you are returning your product, please contact the dealer for their returns policy.

## Leaving A Review

We work very hard to give all of our customers the best possible service. If you have any problems, before leaving negative feedback, please contact us to give us a chance to resolve the issue. We would be delighted if you left us positive feedback!

To leave a review, please go to: [uk.trustpilot.com/review/hyundaipowerequipment.co.uk](http://uk.trustpilot.com/review/hyundaipowerequipment.co.uk)

## Ordering Spare Parts

You can find the spare part you are looking for in the 'Spare Parts' section of this manual or visit [power-spares.co.uk](http://power-spares.co.uk)



# Our Product Range

## Generators

Leisure Inverter, Petrol, Diesel And Built-In Motorhome Generators

## Pressure Washers

Petrol, Diesel And Electric Pressure Washers

## Water Pumps

Submersible, Clean And Dirty Water And Professional Chemical Water Pumps

## Lawnmowers

Petrol, Cordless, Electric, Roller, Self Propelled, Electric Start And Robotic Lawnmowers

## Grass Trimmers And Brush Cutters

Petrol, Cordless, Electric And Wheeled Grass Trimmers And Brush Cutters

## Chainsaws

Petrol, Cordless And Electric Chainsaws

## Hedge Trimmers

Petrol And Cordless Hedge Trimmers

## Leaf Blowers

Petrol, Electric, Cordless, Backpack And 3 -in-1 Leaf Blowers

## Log Splitters

Horizontal, Vertical, Petrol And Electric Log Splitters

## Wood Chippers

Petrol And Electric Start Wood Chippers

## Tillers

Petrol Garden Tiller And Cultivator

## Earth Augers And Trenchers

Petrol Earth Augers And Heavy Duty Trenchers

## Compactor Plates

Petrol Compactor Plates

## Cement Mixers

Portable Electric Cement Mixers

## Mini Dumpers

4-Wheel Drive Mini Dumpers And Tracked Dumpers

## Yard Sweeper

Self Propelled Yard Sweeper Power Brush

## Scarifiers

Petrol Lawn Scarifier And Aerator

## Stump Grinders

Petrol 4-Stroke Stump Grinders

## Welders And Plasma Cutters

MIG, TIG, MMA, ARC Welders And Plasma Cutters

## Power Tools And Tool Chests

Electric And Cordless Power Tools And Filled Tool Chests

## Vacuum Cleaners

Wet And Dry Vacuum Cleaners

## Engines

Petrol And Electric Start Engines

## Battery Chargers / Starters

6V, 12V, 24V Battery Chargers, Jump Starters And Hydraulic Floor Jack

## Air Compressors

Home, Domestic, DIY And Professional Use Air Compressors

## Lighting Towers

Mobile Lighting Towers With Diesel Generators

## Portable Power Stations

Camping Power Packs And Solar Chargers

## And More

We Are Constantly Expanding Our Range With New Products

If you would like more information on any of these products, please contact our sales team on 01646 687880 or visit our website [www.hyundaipowerproducts.co.uk](http://www.hyundaipowerproducts.co.uk)



# Product Information

## Information

As soon as you have purchased the machine, we recommend that you fill out the following. If you need to contact an authorised dealer or customer service for information on servicing, you may need to provide the following information.

The model number and serial number can be found on the grey specification sticker on your machine.

Date Of Purchase: .....

Dealer Name:.....

Dealer Phone:.....

Model Number:.....

Serial Number:.....

## Service Record

### 1st Service

Date Of Service.....

Next Service Due.....

### 2nd Service

Date Of Service.....

Next Service Due.....

### 3rd Service

Date Of Service.....

Next Service Due.....

### 4th Service

Date Of Service.....

Next Service Due.....



# Need Help? Talk To Our Experts

## Contact Us

Our friendly aftersales team will be more than happy to help you.



### Phone

Call our team on 01646 687880, open Monday-Friday 8.30am-5pm.



### Email

[aftersales@hyundaipowerproducts.co.uk](mailto:aftersales@hyundaipowerproducts.co.uk)



### Online Live Chat

Go to [www.hyundaipowerproducts.co.uk](http://www.hyundaipowerproducts.co.uk)

Live chat is open Monday-Friday from 8.30am-5pm.



### Post

Genpower Limited, Isaac Way, Pembroke Dock, Pembrokeshire, SA72 4RW, UK.



# HYUNDAI

POWER PRODUCTS

Importer:  
GENPOWER LTD  
Isaac Way, London Road,  
Pembroke Dock, UNITED KINGDOM, SA72 4RW  
T: +44 (0) 1646 687 880 F: +44 (0) 1646 686 198  
E: [info@hyundaipowerproducts.co.uk](mailto:info@hyundaipowerproducts.co.uk)  
[www.hyundaipowerproducts.co.uk](http://www.hyundaipowerproducts.co.uk)

Imported/Distributed by Genpower Ltd for The United Kingdom & Ireland

Licensed by Hyundai Corporation, Korea

