



Item #211-4774 Model # M36FC
Item #211-4775 Model # M36FCTB
Item #211-4776 Model # M36FCTR
Item #211-4777 Model # M36FCW

USE AND CARE GUIDE

36 IN Tall Storage Cabinet

Questions, problems, missing parts?
Before returning to the store, call
1-866-441-5080
9 a.m – 5 p.m., CST, Monday-Friday

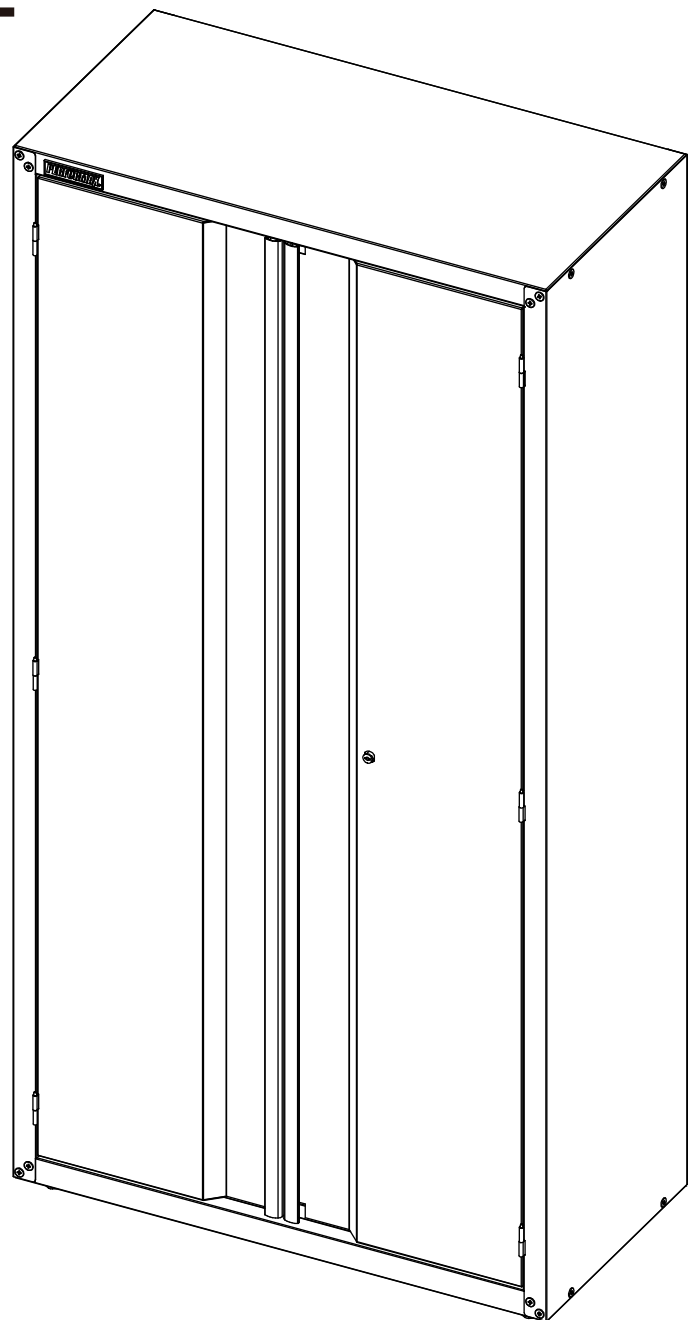

Table of Contents

Table of Contents.....	2	Assembly	5-7
Safety Information	2	Maintenance.....	8
Warranty	3	Replacement Parts	8
Specifications	3		
Package Contents.....	3-4		

Safety Information

To reduce the risk of injury, please read and follow the safety instructions below before assembling and using this product.

1. This product is not designed for commercial or industrial storage.
2. This product is intended for indoor use only.
3. Do not alter this product in any manner. For example, do not weld external lock bars or attach electrical equipment.



CAUTION: Do not attach or mount this product to a vehicle or mobile trailers. This may cause personal injury or product damage. Mounting this product to any vehicle or mobile trailers in any manner will void warranty.



CAUTION: Do not stand on this product. You may fall which may cause personal injury or product damage.



CAUTION: Keep the product on level surfaces. The product may become unstable and tip if stored or moved on an unlevel surface, which may cause personal injury or product damage.



CAUTION: Lock the door if moving this product. The doors could come open and make the product unstable and tip, which may cause personal or product damage.



CAUTION: It is recommended to secure this product to the wall to prevent accidental tipping.

Limited Lifetime Warranty

PERFORMAX® tall cabinets are warranted to be free from defects in materials and workmanship under normal use for the lifetime that you own the product. If any part of the product is found to be defective during normal use, the defective product or part will be replaced at our discretion. This warranty does not cover products that are damaged through accident, abuse, misuse, commercial/industrial applications or neglect. This warranty also does not cover any losses, injuries or costs including indirect, incidental or consequential damages. This warranty may not be transferred or sold. When requesting warranty service please call 1-866-441-5080 and have the model number, cash register receipt and the date of purchase available when you call. If the product is defective, we will replace the defective part at no cost to you. Some states do not allow the exclusion or limitation of incidental damages, so the above limitations or exclusions may not apply to you. This warranty gives you specific legal rights and you may have other rights, which vary from state to state.

Specifications

Maximum Load Capacity (per shelf)

150 lbs.



NOTE: Begin product assembly close to the final intended location of your cabinet. This product is heavy and may be difficult to move after assembly.

Package Contents

HARDWARE INCLUDED



NOTE: Hardware not shown to actual size.

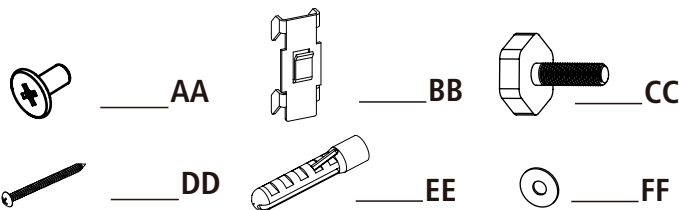

Part	Description	Quantity
AA	M6x10 Screw	51
BB	Shelf Mount	12
CC	Leveling Feet	4
DD	ST6.3x75 screw	2
EE	Drywall Anchor	2
FF	Washer	2

ALTERNATIVE TOOLS FOR ASSEMBLY (Not Included)

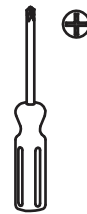

Phillips Screwdriver

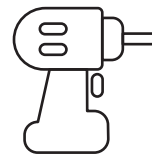

Power Drill

Package Contents (continued)

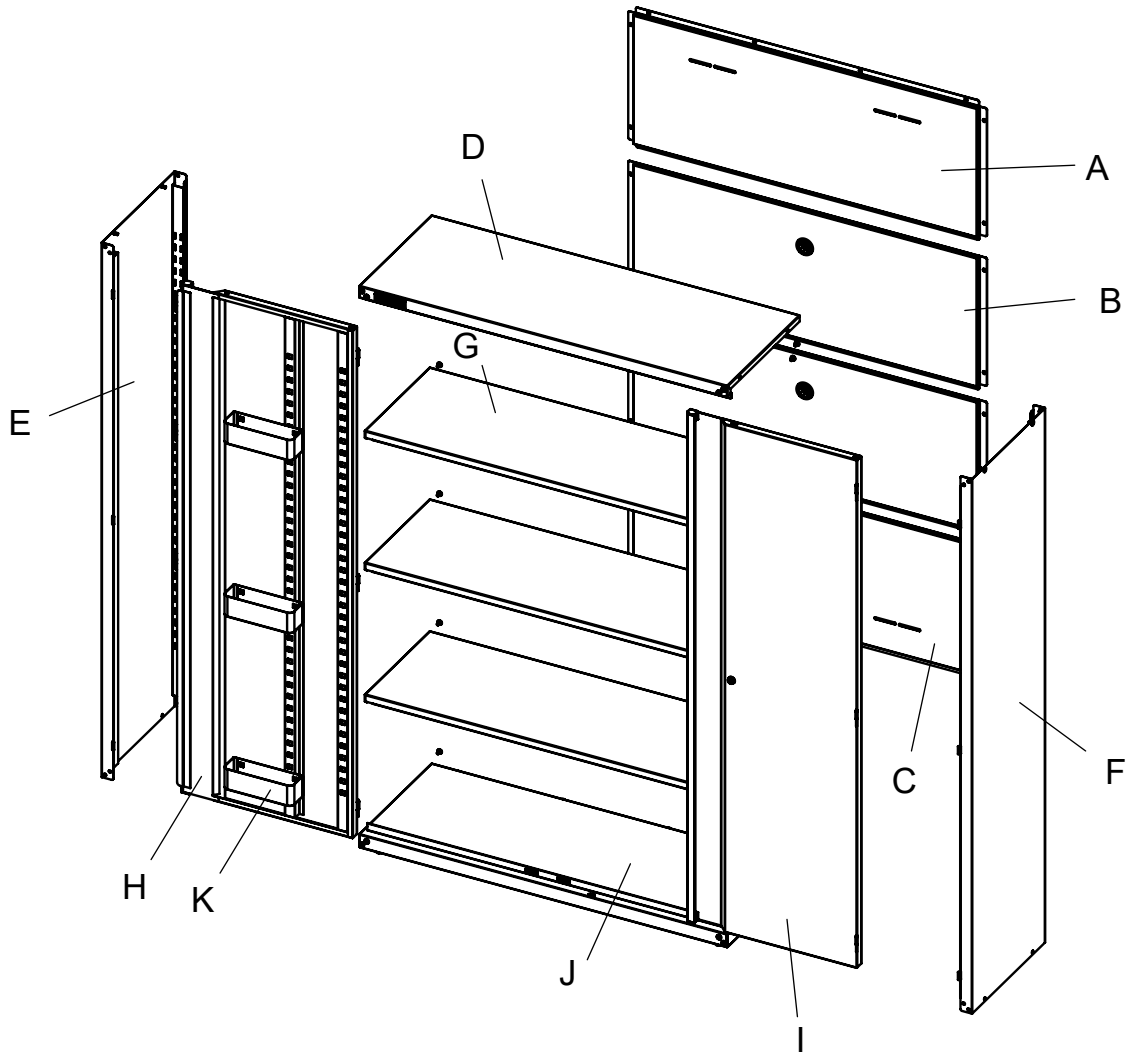

Part	Description	Quantity	Part	Description	Quantity
A	Back Panel-top	1	F	Right Side Plate	1
B	Back Panel-middle	2	G	Adjustable Shelf	3
C	Back Panel-bottom	1	H	Left Door	1
D	Top Panel	1	I	Right Door	1
E	Left Side Plate	1	J	Bottom Panel	1
			K	Storage Tray	6

Assembly



CAUTION: Two people are recommended for assembly.

1 Unpacking instructions

- Remove all parts and hardware from the shipping box. Check the contents against the PARTS and HARDWARE lists on the previous page. If parts or hardware are missing, please call 1-866-441-5080 for assistance.
- To assure the squareness of the unit, do not fully tighten the screws until the cabinet is fully assembled and level.

2 Attaching the Leveling Feet

- Attach the Leveling Feet (CC) to Bottom Panel (J) and tighten.

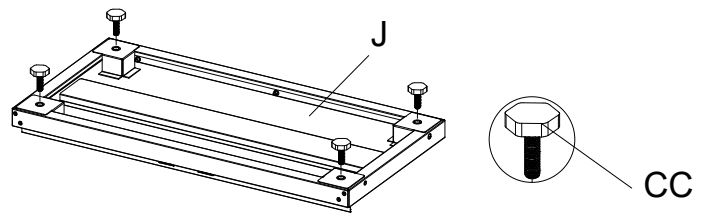

3 Attaching the Side Panels

- Attach Left Side Panel (E) and Right Side Panel (F) to Bottom Panel (J) with 10 screws (AA).
- Do not fully tighten.

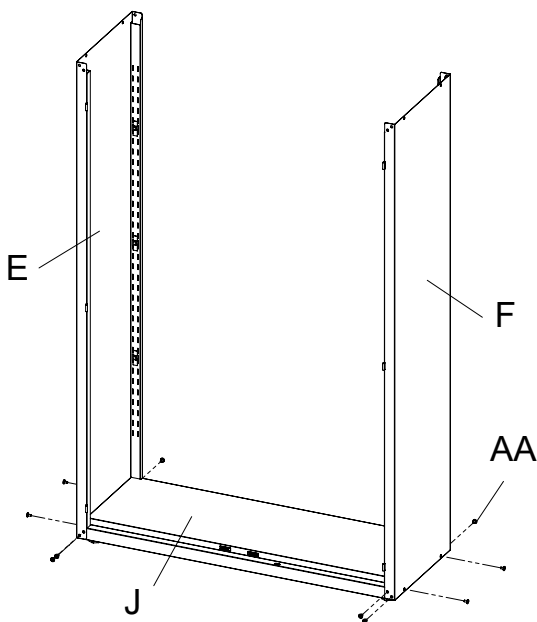

4 Attaching the Top Panel

- Attach Top Panel (D) to the Side Panels (E) and (F). Align holes on the sides and back and secure with 10 screws (AA).
- Do not fully tighten.

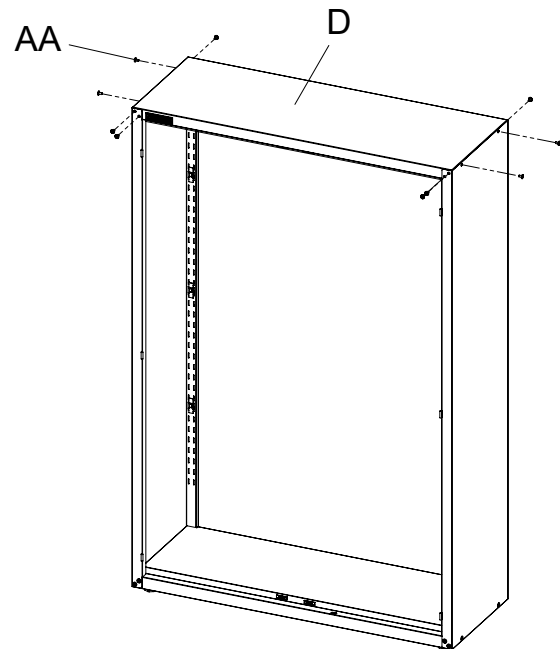

5 Attaching Back Panel

- Attach Back Panel-bottom (C) inside the two side panels and bottom. Align and insert 7 screws (AA) into holes but do not fully tighten.
- Attach the two Back Panel-middle (B) inside the two side panels and bottom. Align and insert 14 screws (AA) into holes but do not fully tighten.
- Attach Back Panel-Top (A) inside the two side panels and bottom. Align and insert 10 screws (AA) into holes but do not fully tighten.

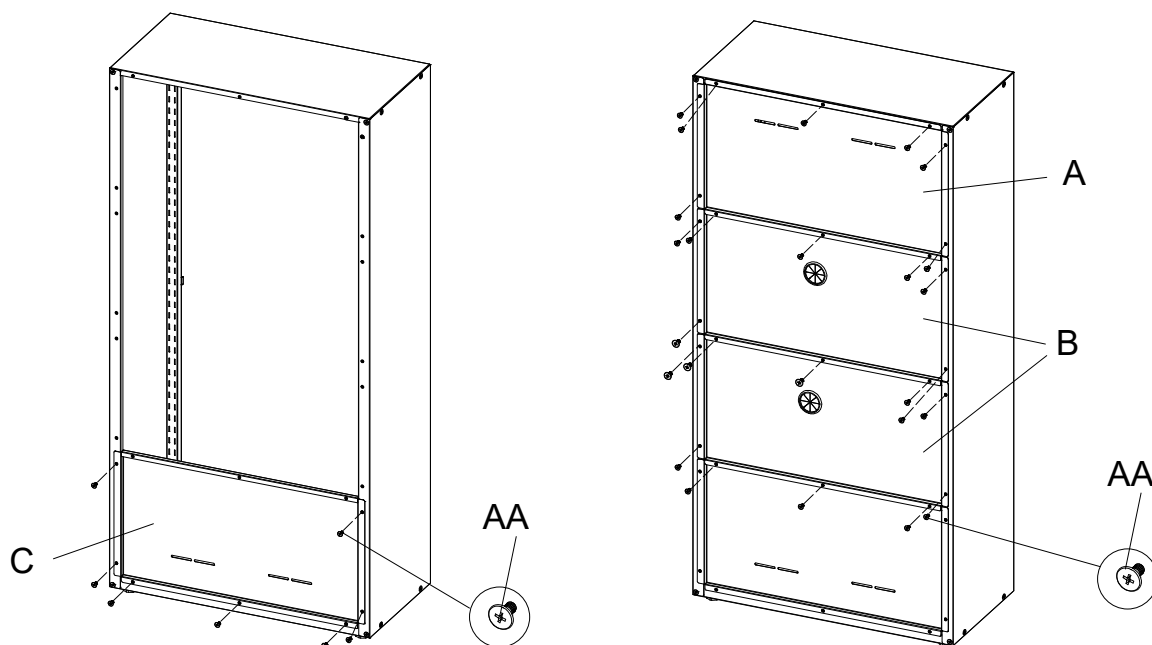

6 Attaching Adjustable Shelf

- Determine the desired height of your shelf.
- Attach and install four of the Shelf Mounts (BB) for each shelf to the front and rear corners.
- Insert Adjustable Shelf (G) into cabinet.

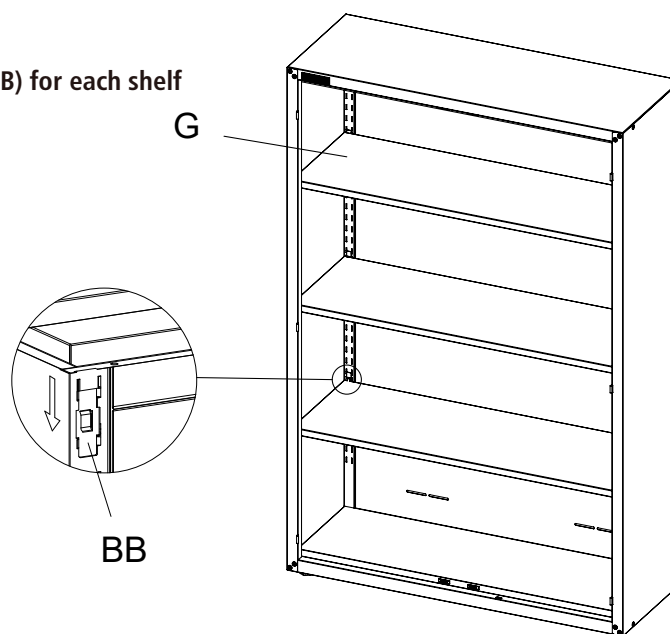

7 Attaching the door

- Align the holes on the hinge of the Left Door (H) to the holes on the Side Panel.
- Repeat process for the right door (I with lock assembly).

Note: To maintain proper operation of the cabinet doors, ensure the cabinet is completely level by adjusting the four Leveling Feet (CC).

- Once cabinet is square and level, go back and tighten all screws used in assembly.

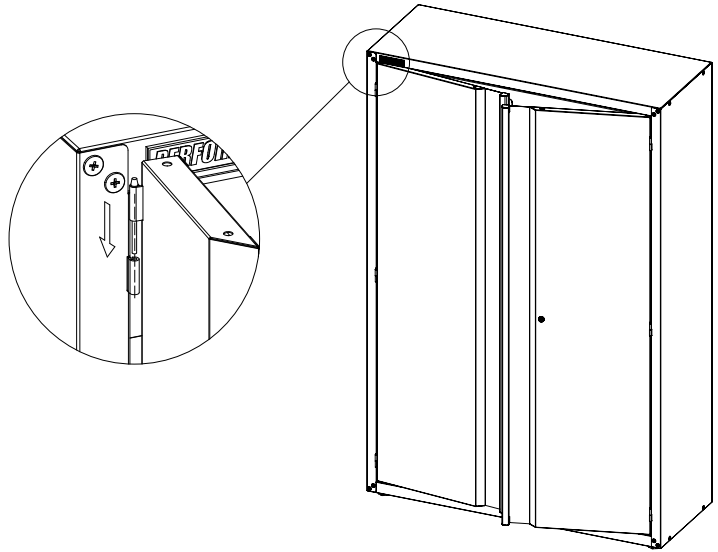

8 Securing to a Wall

- Measure and mark the location of the left and right attachment holes on the wall.
- Drill a 5/16" hole on the left and right side and insert the Drywall Anchor (EE) into the holes. Use the ST6.3x75 screw (DD) and washer (FF) to secure each side of the the Back Panel (A) into the Drywall Anchor (EE).

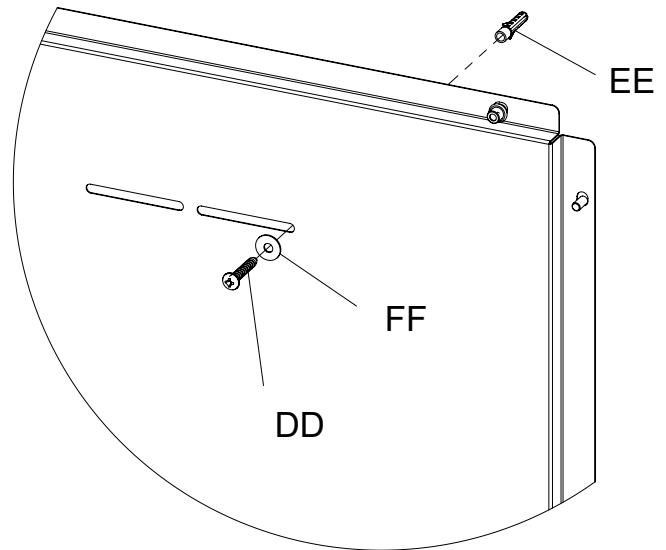
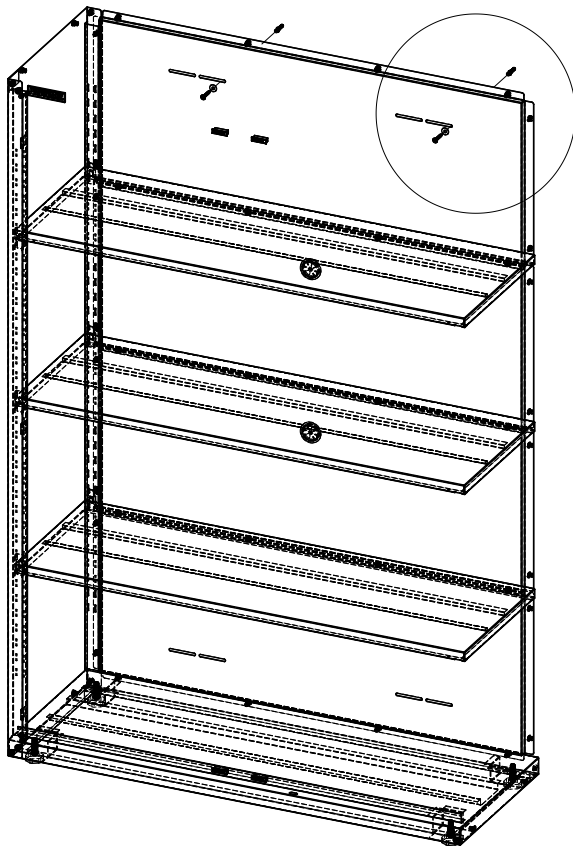

Maintenance

- Periodically the surfaces should be cleaned with a mild detergent and water.

Replacement Parts

For assistance with replacement parts please call 1-866-441-5080.

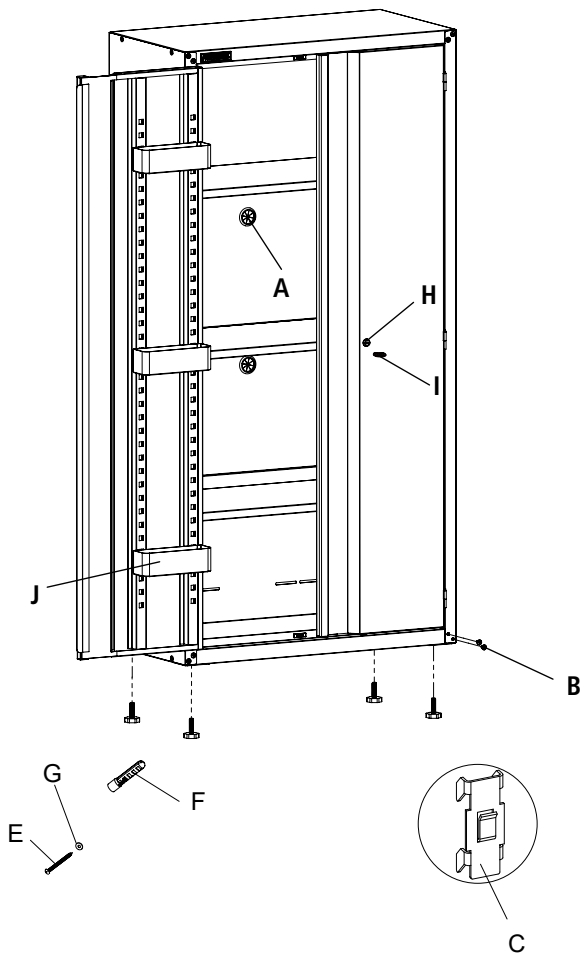

Part	Description	Quantity
A	Rubber grommet	2
B	M6x10 Screw	51
C	Shelf Mount	12
D	Leveling Feet	4
E	ST6.3x75 screw	2
F	Drywall Anchor	2
G	Washer	2
H	Lock	1
I	Key	2
J	Storage Tray	6